

# YAMAHA MRX-100

*Learning-Capable  
Multi-function Remote Control*

*Télécommande multi-fonctions  
programmable*

*Lernfähiger  
Mehrfunktions-Fernbedienungsgeber*

*Programmerbar fjärrkontroll  
med många funktioner*

*Telecomando multifunzione  
capace di apprendimento*

**CENTER**

OWNER'S MANUAL  
MODE D'EMPLOI  
BEDIENUNGSANLEITUNG  
BRUKSANVISNING  
MANUALE DELL'UTENTE

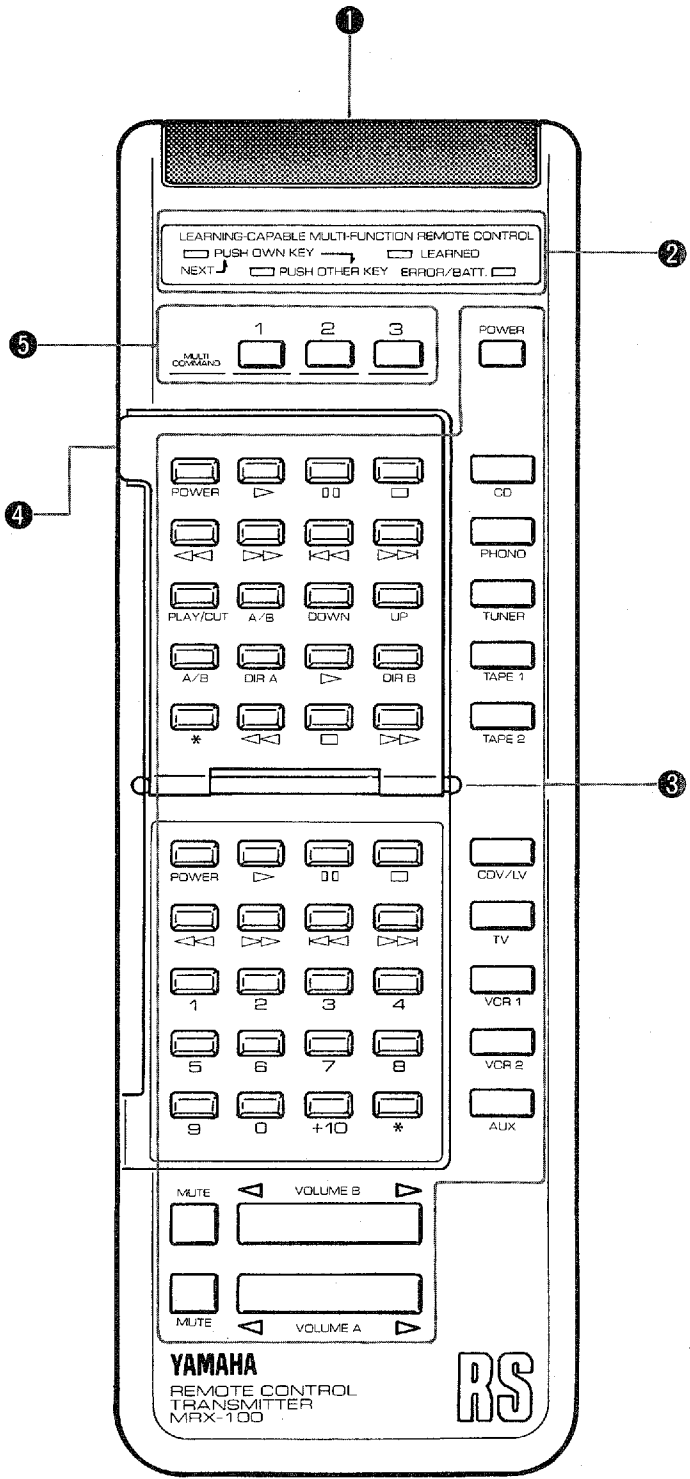

*Thank you for purchasing the YAMAHA MRX-100 remote control transmitter.*

The MRX-100 is a "learning" (programmable) remote control unit that allows for the centralized control of various Audio/Video equipment, thus solving the complicated problem of operating several remote controllers for your system.

The MRX-100 incorporates 95 single-operation programmable keys. Each key has a large storage capacity so that it can store even a long command (a series signal, for example).

The multi-command (a series programming) feature can store up to 15 kinds of commands under a single key, thereby making it possible to perform a series of operations for several different units by just pressing one key.

Because the MRX-100 can store a wide variety of command formats, it is far superior to ordinary "learning" remote controllers.

---

**CAUTION: READ THIS BEFORE OPERATING YOUR MRX-100.**

1. To ensure proper operation and maintenance, please read this instruction manual thoroughly. Once you have read it, keep it in a safe place for future reference.
2. The MRX-100 is a sophisticated remote control transmitter. Do not drop, hit, or subject it to other shocks.
3. Do not operate or store the MRX-100 in or near the following:
  - a. Sources of heat such as radiators, heaters, direct sunlight, etc.
  - b. Sources of cold such as air conditioners, etc.
  - c. Sources of moisture such as sinks, bath tubs, showers, aquariums, etc.
4. Do not attempt to use solvents to clean the MRX-100; this might damage the finish. Use a clean dry cloth.
5. Never open the unit yourself for any reason. No user serviceable parts are inside. If you encounter problem, refer to page 12. If the unit is still defective after checking those points, contact your YAMAHA dealer or service center.

**NOTE**

The MRX-100 cannot be used with some remote controller.

## ■ BATTERY INSTALLATION/REPLACEMENT

- Install the batteries as shown below.

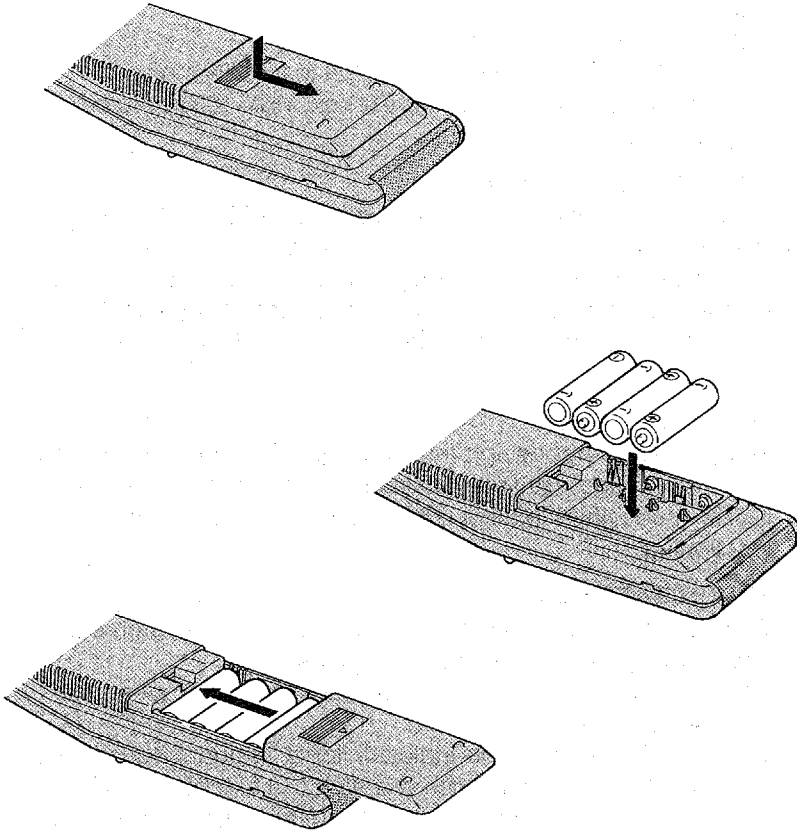

- When the ERROR/BATT. indicator lights three times after operating a key, the batteries are weak. Replace the batteries at this time.
- All of the memorized functions will be retained while you replace the batteries. However, if no batteries are installed for a few hours, the memory will be erased and will have to be programmed again.
- Be sure to follow the diagram at the bottom of the compartment to insure proper positive (+) and negative (-) polarity.
- Do not use old and new batteries together.
- When the unit is not to be used for a long period of time, remove the batteries from the battery compartment. Should battery fluid leaks, wipe away the fluid in the battery compartment thoroughly before inserting new batteries.

## ■ CONTROLS AND FUNCTIONS (See figure on page 1.)

### ① Head

This portion of the MRX-100 emits and receives infrared signals.

### ② Indicators

#### **PUSH OWN KEY indicator**

This indicator lights when the unit is set to LEARN mode. It prompts you to select and press the next MRX-100 key to be programmed.

#### **PUSH OTHER KEY indicator**

When in LEARN mode, pressing a key on the MRX-100 will cause this indicator to flash for about 20 seconds.

During this time the MRX-100 is prepared to receive a command from the other remote controller. It lights steadily for about 2 seconds while receiving a command from another remote controller.

#### **LEARNED indicator**

When in LEARN mode, this indicator lights for about 2 seconds to confirm the successful memorization of a command. When in NORM mode, this indicator lights to indicate that a key pressed is functioning.

#### **ERROR/BATT. indicator**

This indicator lights when a key in which signal is not stored or when two keys are pressed simultaneously.

When this indicator lights three times after operating a key, the batteries are weak.

When in LEARN mode, this indicator lights for about 2 seconds to indicate the unsuccessful memorization of a function. When in NORM mode, this indicator lights when a key with no memorized function is pressed.

### ③ Learning keys

The signals of other remote controllers can be programmed for use with these keys.

Each key is marked with a symbol indicating its function.

However, by using the supplied decals, the symbol indications can be changed to match the function layout of other remote controllers.

In addition, a flip card is provided for the center 40 keys so that two types of signals can be programmed for each of them.

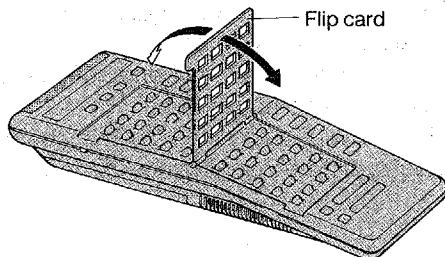

Do not apply a decal on another decal, otherwise the flip card may not close securely and correct operations may not be obtained.

**4 NORM-LEARN switch**

This switch is used to select between the LEARN and NORM modes.

**5 MULTI COMMAND keys (1, 2, 3)**

These keys are used for multi-command programming. Each key can store up to 15 kinds of commands in series, consisting of the learning key commands. This makes it possible to perform a series of operations, or the operations of several different units, by just pressing a key. However, note that these keys cannot store the commands of other remote controllers directly.

**■ OPERATIONS****TO PROGRAM THE SIGNALS OF OTHER REMOTE CONTROLLERS**

How many remote controllers are you using in your system?

The MRX-100 has 95 “learning” keys, for which the functions of other remote controllers can be programmed.

By programming the same signals as those used with your existing remote controllers, the MRX-100 can be used as the only remote controller in your system, making your A/V life easier than ever.

To program the signals of another remote controller in the MRX-100, please follow these steps.

1. Switch the NORM-LEARN switch to the LEARN position. The PUSH OWN KEY indicator will light.

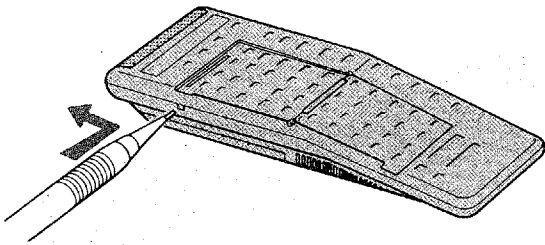

2. Position the MRX-100 and the other remote controller head to head.

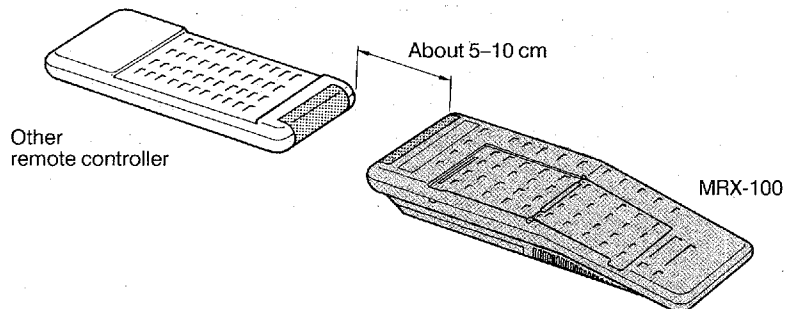

3. Select and press the key to be programmed on the MRX-100.

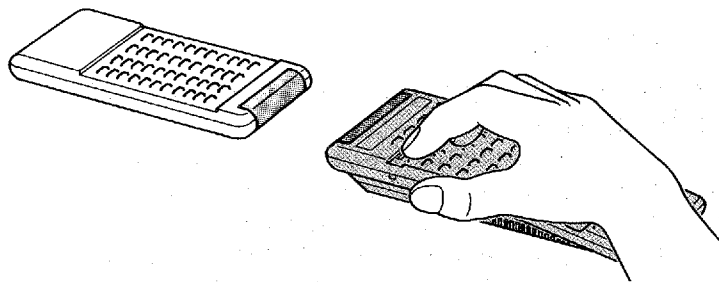

4. The PUSH OTHER KEY indicator will flash. At this time you have about 20 seconds to press the key for the function on the remote controller to be memorized.

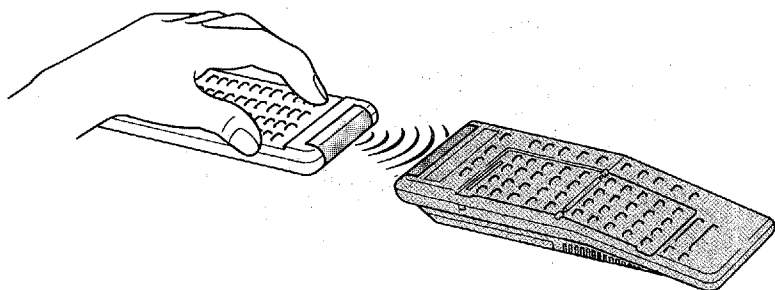

The PUSH OTHER KEY indicator will light steadily while receiving the command from the other remote controller. Hold down the key of the other remote controller until this indicator turns off. The LEARNED indicator will light for about two seconds if the memorization of a command has been successfully completed. Note that the successful programming of a key replaces its previous command. If the memorization of a command is unsuccessful, the ERROR/BATT. indicator will light for about 2 seconds or twice. If this happens, please try again.

5. Repeat steps 3 and 4 until all programming is complete.
6. Once programming is complete, set the NORM-LEARN switch to the NORM position.

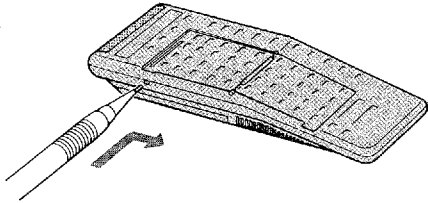

After the programming has been completed, try operating the MRX-100.

If programming is not carried out successfully or if the remote control does not function although programming was successful, check the followings:

- Check if the batteries of the other remote controller are weak. In this case, even when another remote controller can operate a unit, its command signal strength is too weak for the MRX-100. Replace the batteries of the other remote controller.
- Check if the distance to the other remote controller is too small or too large.
- Check if a strong light, such as direct sunlight, is striking the head of the MRX-100.

**When PUSH OTHER KEY indicator blinks rapidly**

When the command to be stored is too long, the MRX-100 automatically enlarges the work area capacity, and then stands by for the second entry. Please try storage the operation again.



## MULTI COMMAND PROGRAMMING

Up to 15 signals of those programmed under the learning keys, can be stored under one MULTI COMMAND key.

For a routine operations, such as listening to and watching a video tape, the following are required.

1. Turn the amplifier power ON.
2. Turn the video deck power ON.
3. Turn the monitor TV power ON.
4. Select the amplifier's VIDEO input selector.
5. Set the video deck to Play mode.

By storing a sequence of these signals under a single key, all of these operations can be activated by just pressing that key.

To program the signals of several learning keys under one of the MULTI COMMAND keys, follow these steps.

1. Set the NORM-LEARN switch to LEARN. The PUSH OWN KEY indicator will light.

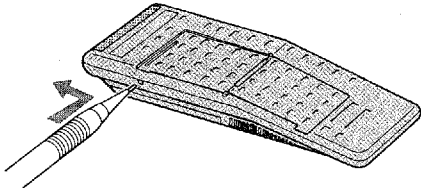

2. Press the MULTI COMMAND key to be used for storing the sequence of signals. The PUSH OTHER KEY indicator will blink.

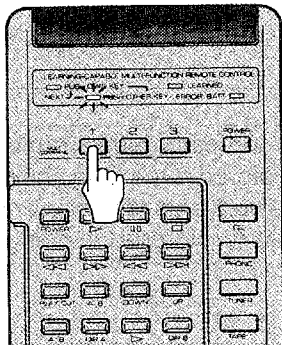

- 3. Press the same MULTI COMMAND key again. The PUSH OTHER KEY indicator will light steadily.

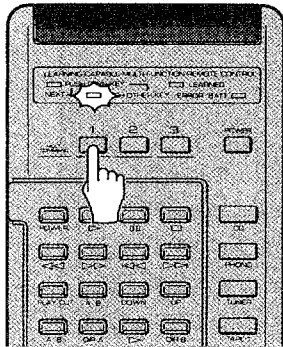

- 4. Press the learning key under which the signal for the first operation (amplifier power ON, for example) was programmed. The LEARNED indicator will light for a short time.

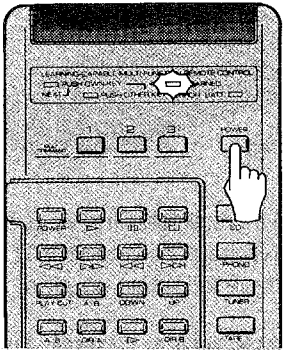

- 5. When the PUSH OTHER KEY indicator lights again, press the learning key under which the signal for the next operation (video deck power ON, for example) was programmed.

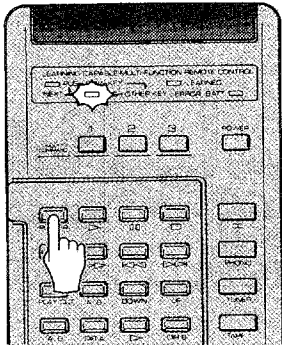

When a series signal (volume control, for example) is stored under a MULTI COMMAND key, this signal will be transmitted for a short time.

- Repeat the operations in step 5 until all signals have been stored, then press the MULTI COMMAND key. The LEARNED indicator again will light for a short time.

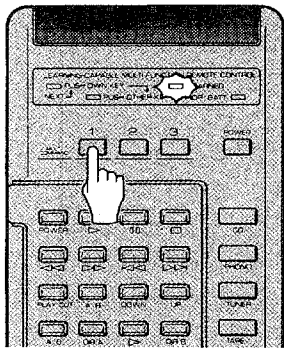

When the 15th command is stored under a MULTI COMMAND key, the LEARNED indicator lights for a while. In this case, it is not necessary to press the MULTI COMMAND key.

- Set the NORM-LEARN switch to NORM.

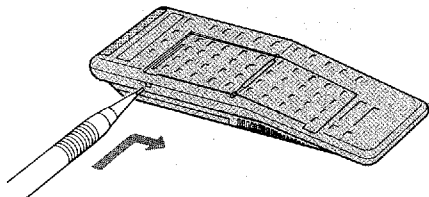

A sequence of signals from several learning keys has now been stored under one MULTI COMMAND key. Try the MULTI COMMAND key operation, but keep in mind the following caution.

**OPERATION RANGE OF THE MULTI COMMAND FUNCTION**

When a multi command operation of several different units is required, check the positioning of their remote control sensors, as well as the pointing direction of the MRX-100.

The remote control sensors of all equipment must be located within the operation range.

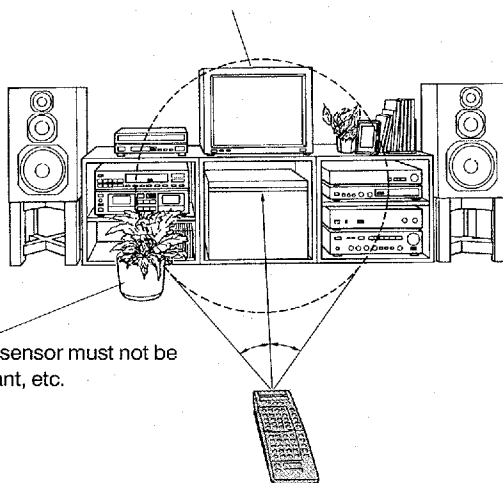

The remote sensor must not be behind a plant, etc.

If multi-command programming is not carried out successfully, or if the multi-command remote control does not function although multi-command programming was successful, check the following:

- Check if each learning key functions correctly.
- Check if the order of the multi-command commands was correct. The commands are transmitted in the order of their storage.
- If the controlled equipment takes a relatively long time to start an indicated operation after receiving a command, the next command could be transmitted to the equipment before it is ready to receive it.

In such a case, the recommended method for gaining time between two required commands is to insert the required number of identical commands as the first command, or to insert other non-effective signals between them.

**Important!!**

If a multi-command operation does not completely function, for any reason (because there was an obstacle between the sensor and the MRX-100, the MRX-100 was too far from the sensor, it was pointed in the wrong direction, etc.), be sure to re-set the operated equipment to the state before the MULTI COMMAND key was pressed.

If you press the MULTI COMMAND key again, without having reset the state, the resulting operations could be different from those expected.

## ■ TROUBLESHOOTING

If you encounter problem when operating the MRX-100, please check the following points.

Symptom	ERROR /BATT. indicator status	Possible Cause	Remedy
Programming impossible	Lights for about 2 seconds	Noise may have been introduced in the signal.  The batteries of the other remote controller is nearly exhausted.	Perform the programming operation again.  Replace the batteries of the other remote controller with new ones.
	Blinks twice	When the signal of the other remote controller lasts too long, the internal processing system is automatically expanded and then enters the waiting mode for the next input signal.  There are various types of infrared remote control signals, such as a signal having extended length, etc. To obtain compatibility with these signals, when the MRX-100 receives such a signal, the ERROR/BATT. indicator lights twice, the signal processing ability is automatically expanded, and the MRX-100 then waits for the signal to be input again. In this waiting mode, the PUSH OTHER KEY indicator blinks rapidly to show that the internal signal processing ability has been expanded.	Perform the programming operation again.
	Blinks three times	Batteries are nearly exhausted.	Replace the batteries of the MRX-100 with new ones.

Symptom	ERROR/ BATT. indicator status	Possible Cause	Remedy
Program- ming is completed, but the object component does not work.	Blinks three times	Batteries are nearly exhausted.	Replace the batteries of the MRX-100 with new ones.
		Noise has been learned together with the object signal.	Perform the programming operation again.
		Incorrect signal is stored.  If a signal, such as for the power switch, has been stored by pressing the button twice in a very short interval, the power of the object component may be turned ON, then OFF immediately.	Perform the programming operation again.
		The remote sensor of the object component is obstructed.	Remove the obstacle so as not to block the remote sensor.
		The object component has a remote sensor with an ability which is too low to receive the infrared signal from the MRX-100 at a distance.	Operate from a closer position.
		Continuous operations, such as the volume control or picture search of a VCR, is impossible. Operation is possible only non-continuously.  If the object key is pressed momentarily during a learning operation, it may be stored as a single (non-continuous) signal. Keep pressing the required key on the object remote controller until the PUSH OTHER KEY indicator goes out.	Perform the programming operation again.

Symptom	ERROR/ BATT. indicator status	Possible Cause	Remedy
Multi-command programming is impossible	Blinks three times	Batteries are nearly exhausted.	Replace the batteries of the MRX-100 with new ones.
Multi-command operation is impossible	Blinks three times	Batteries are nearly exhausted.	Replace the batteries of the MRX-100 with new ones.
		The signal stored under each learning key is incorrect.	Check the operation stored in each learning key beforehand.
		The order of the multi-command operation is unsuitable.	Perform the programming again in the correct order.
		Remote sensor of the object component is placed too far away from the MRX-100.	Operate it at the closer position.
		The remote sensor of the object component is obstructed.	Remove the obstacle so as not to block the remote sensor.
		The object components do not function in correspondence with a signal continuously transmitted (series signal) from the MRX-100.	Change the sequence of the multi-command operations.
		<p>Immediately after turning the power ON, or when an object component needs a long processing time, the multi-command operation of the succeeding signal may not be accepted. In this case, insert a signal to change the input selection of an amplifier, etc. between the signals for the multi-command operation so that a certain margin is given to the sequential operation.</p>	

If the problem still persists after checking these points, the signal coding and modulation system of the other remote controller are probably different from those of the MRX-100 and the MRX-100 cannot "learn" them.

**■ SPECIFICATIONS**

Battery Type .....	Size "AA" or R06
Dimensions (W x H x D) .....	74 x 218 x 35 mm (2-15/16" x 8-9/16" x 1-3/8")
Weight .....	240 g (8 oz)
Supplies Accessories .....	Batteries (size "AA", R06) x 4 Sheet of adhesive labels x 1



**YAMAHA**