



Electone® *STAGEA*®  
ELS-01/01C typeU

---

Playing the ELS-01/01C  
Tutorial

STAGEA



# About This Manual

(Read this first!)

This manual is made up of four chapters, each focusing on a single song for you to practice. By playing and working on each song, you'll build up your knowledge and experience of using the ELS-01/01C, and increase your familiarity with the functions of the instrument naturally. If you're already familiar with the Electone or have experience playing one, feel free to start somewhere in the middle of the book, rather than the beginning. The point is to learn things about the Electone that you may not have known before, and to use them effectively in your performance.

When you need more specific instructions or want to explore a feature or function in greater detail, refer to the separate Owner's Manual.

In addition, the Owner's Manual contains basic information about the ELS-01/01C, such as the Panel Layout and Basic Operations (pages 8 – 21), helpful sections you should read before working through this booklet.

Now, go to the next page and take a look at the brief overviews of each chapter.

## Playing with the Registration Menus

Song:

“Grandfather’s Clock”

Simply select the Registration from the Registration Menu and play the song. It’s not a difficult piece to play, but if you’re unfamiliar with the score, try slowing down the rhythm and playing it at a more relaxed pace. Enjoy performing with the clear oboe melody and the beautiful strings harmony.

## Editing a Registration and Storing it to Registration Memory

Song:

“Dancing Queen”

Here, you’ll select a Registration from the Registration Menu, then slightly edit it and save to Registration Memory. Three Registration Memories (M1, M2, and M3) are used in this song. You’ll also save these Registrations to a USB flash memory. Finally, play the song and use the right footswitch to change the Registration Memory. The Lower keyboard and Pedalboard parts are very simple, letting you master this piece quickly.

- |          |          |   |
|----------|----------|---|
| <b>M</b> | <b>1</b> | <b>Creating a Simple Intro Sound based on the Registration Menu</b> |
| <b>M</b> | <b>2</b> | <b>Slightly Editing the Intro Sound</b>                             |
| <b>M</b> | <b>3</b> | <b>Enjoying the Original Sound of the Registration Menu</b>         |

## Selecting and Editing Voices

### Working with Rhythm Sequence and Registration Sequence

Song: “Change the World”

In this chapter, we’ll work on creating each Registration from scratch, instead of using the Registration Menu. First, select the Voices for each Voice section and apply some controls and effects. Then, program a Rhythm Sequence and Registration Sequence. These allow you to play the song with all the necessary changes made automatically — without your having to use the footswitch, switch Registrations or select different rhythms. Finally, record the settings and your performance to a USB flash memory.

M	1	Intro with Acoustic Guitar and Electric Piano
M	2	Classic Rock Organ
M	3	Sweet Harmonica Melody
M	4	Soft Harmony with Pad Sound on the Lower Keyboard
M	5	Mysterious Arpeggio with Delay
M	6	Electric Guitar Solo
M	7	Ending with Acoustic Guitar and Electric Piano

## Creating Various Organ Sounds (ELS-01C)

Song: “Moldau”

The Organ Flutes function (not available on the ELS-01) lets you create various organ sounds — such as those of a traditional pipe organ, gorgeous jazz organ, and more. “Moldau” is a short song, yet it includes a very colorful organ sound. Enjoy all of the sounds from your head down to your feet.

M	1	Classical Sound
M	2	Soft Jazz Sound
M	3	Tasty Jazz Sound
M	4	Colorful Jazz Sound
M	5	Percussive Rock Sound
M	6	Classical Sound (same as M1)

# ACT 1

## Playing with the Registration Menus

Song:

“Grandfather’s Clock”

One of the most exciting aspects of the Electone is its abundance of realistic Voices and dynamic rhythms. For details on exactly what Voices and rhythms are available, check the Voice List and Rhythm List in the Owner's Manual (pages 30 and 59). With all the hundreds of choices available, you may have a difficult time finding which is best for a particular song. That's where the Registration Menu comes in handy.

Registration Menu contains 48 Registrations (60 on the ELS-01C) in five main categories: (1) Kids, (2) Pops & Rock, (3) Dance & Ballad, (4) Jazz & Latin, and (5) Symphony & World. Registration settings in the Registration Menu include not only the Voices for each keyboard — Upper, Lower and Pedal — but also the rhythm and Auto Bass Chord settings. This means you can enjoy playing the Electone with appropriate settings for any style of music or song simply by selecting the desired Registration from the Registration Menu.



#### **Memo** About "Grandfather's Clock"

This plaintive and poignant folk song was written by Henry Clay Work back in 1876, and was one of the two most popular songs that year in the United States — the other being "I'll Take You Home, Kathleen." Standing clocks like the one mentioned in the lyrics were a common fixture in homes across the country, and the image of the clock, as well as the parallel lives of the clock and the old man, captured the hearts of listeners as much as did the beautiful melody. The song has endured, renewing its popularity every generation, and has even left us with the word "grandfather clock" — meaning a standing, tallcase clock.

# Grandfather's Clock

Composed by Henry Clay Work  
Arranged by Riko Morino

ACT 1

ACT 2

ACT 3

ACT 4

\* Notes in parentheses can be ignored.

Musical score for the first system of "Grandfather's Clock". The score is in common time (C) with a tempo of 80. It consists of three staves: a treble clef staff, a grand staff (treble and bass clefs), and a bass clef staff. The treble staff contains the melody with notes: C4, F4, C4, G4, C4, G4. The grand staff shows the piano accompaniment with chords and arpeggios. The bass staff has a single bass line starting with a half note C3. A box labeled "RHYTHM SYNCHRO START" points to the first note of the bass line. Chord symbols above the treble staff are: C, F<sup>on</sup>C, C, G7, C, G<sup>on</sup>B. A dynamic marking of *mp* is present. A repeat sign is located after the first four measures.

Musical score for the second system of "Grandfather's Clock". It continues from the first system. The treble staff contains the melody with notes: C4, F4, A4, D5, F5, C5, G5, C5. The grand staff shows the piano accompaniment with chords and arpeggios. The bass staff has a single bass line with notes: C3, F3, C3, G3, C3. Chord symbols above the treble staff are: C7<sup>on</sup>B<sup>b</sup>, F<sup>on</sup>A, Dm<sup>on</sup>F, C<sup>on</sup>G, G7, C, F<sup>on</sup>G, C, F<sup>on</sup>C, C. A first ending bracket labeled "1." covers measures 7-8, and a second ending bracket labeled "2." covers measures 9-10. A dynamic marking of *mp* is present.



Em7 Am7 F6 G7 Em7 Am7 D7<sup>onF#</sup> G

*mf*

C G<sup>onB</sup> C7 F6 Dm 1. C<sup>onG</sup> G7 C F<sup>onC</sup> C

*dim.*

2. C<sup>onG</sup> G7 C F<sup>onC</sup> C Dm7<sup>onC</sup> C

RHYTHM STOP (with right hand)

*dim.*

# Selecting the Registration for “Grandfather’s Clock” from the Registration Menu

The simple, warm sounds of the oboe and soft strings perfectly match this melodic song, with the rhythm gently echoing the tick-tock sound of the clock.

ACT 1

- 1 Press the REGISTRATION MENU [1] button.  
The Kids Menu appears.

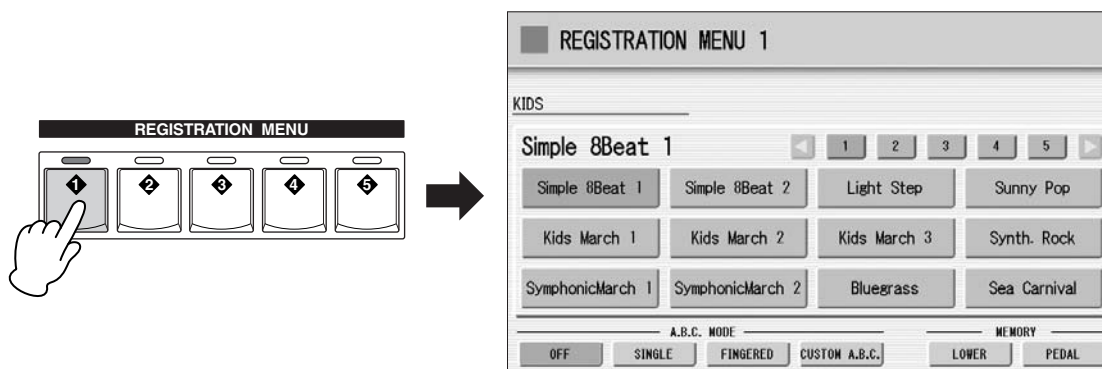

ACT 2

ACT 3

- 2 Select [Simple 8Beat 2] in the Kids Menu.

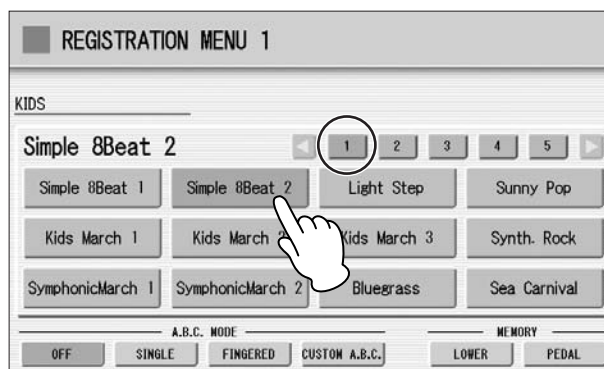

ACT 4

# Playing “Grandfather’s Clock”

## 1 Press the [SYNCHRO START] button.

The lamp above the BAR/BEAT display flashes, indicating the rhythm is set to standby.

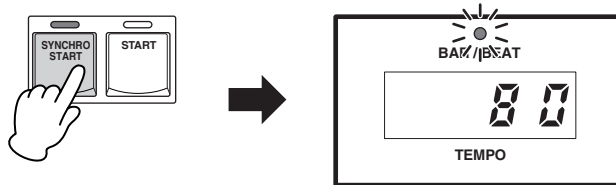

## 2 Play the song.

As soon as you play the first note, the rhythm starts. Try putting some expression into your playing by using after touch (see page 39 of the Owner’s Manual).

## 3 When you come to the last measure, press the [SYNCHRO START] button with your right hand to stop the rhythm.



### NOTE

If you want to play the song at a slower tempo, turn the TEMPO dial counter-clockwise and decrease the tempo to around 70 or so.

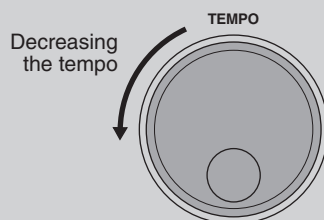

### NOTE

Notice the tied notes in the left hand. When changing chords, be careful not to break up the continuous sound between the chords. The notes in parentheses are optional and can be left out, especially if you have difficulty playing them.

# ACT 2

## Editing a Registration and Storing it to Registration Memory

Song:

Dancing Queen

- M 1** Creating a Simple Intro Sound based on the Registration Menu
- M 2** Slightly Editing the Intro Sound
- M 3** Enjoying the Original Sound of the Registration Menu

In this chapter, first select one of the Registration Menu buttons (as you did in ACT 1), then create three new Registrations by changing the selected Registration. You can save the created Registrations to the Registration Memory buttons first, then save them to a USB flash memory.

Here is a brief rundown of the three Registrations you'll be using in "Dancing Queen." Registration M1 features a clear piano intertwined with warm strings and a distinctive wah guitar in the Lower keyboard. In M2, the Synth Lead performs the melody. The last Registration, M3, is the gorgeous sound of the original Registration Menu itself.



### **Memo** About "Dancing Queen"

The Disco craze of the mid 1970's swept the entire world, resulting in a huge amount of hit songs and many popular artists, such as Earth, Wind & Fire, KC & the Sunshine Band, and the Bee Gees. One of the most successful Disco-flavored acts was ABBA, the Swedish male/female team of songwriters/singers — and "Dancing Queen" was one of their most popular songs. As you'll discover, the Electone has a wide variety of highly danceable rhythms that are ideal for recreating the Disco sound.



# M 1 Creating a Simple Intro Sound based on the Registration Menu

The original Registration Menu we'll use for "Dancing Queen" is full and rich — perfect for this song's main melody. However, it's a bit too extravagant to use in the intro. So, we'll make it a little more simple and sparse, by canceling the Melody On Chord feature and muting the Lead Voice.

1 Press the REGISTRATION MENU [3] button.

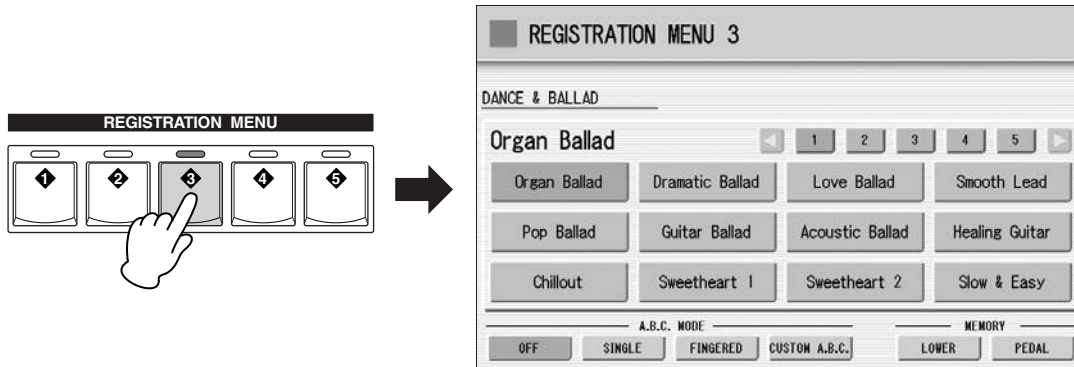

2 Press the [2] button in the display to change the displayed menu page, then select [Disco Queen].



3 Press the [A.B.C./M.O.C.] button to call up the Auto Bass Chord/Melody On Chord display, then set Melody On Chord (M.O.C. MODE) to OFF.

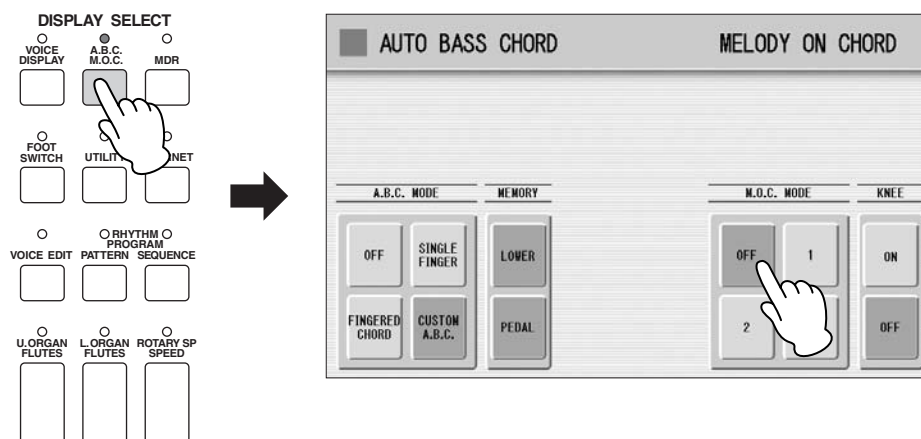

- 4 Press the [VOICE DISPLAY] button, to call up the Voice Display, then mute both Lead Voice 1 and Lead Voice 2. (Press the buttons so they are grayed-out or “ghosted.”)

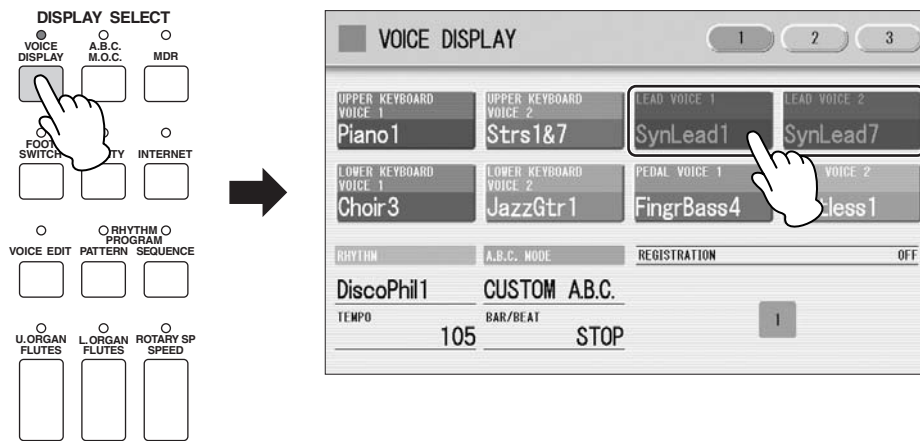

This completes the settings for Registration Memory 1, so record these settings to the [1] button in the Registration Memory section.

While holding down the [M.] (Memory) button in the Registration Memory section, press the [1] button.

1. While holding down [M.] button...
2. Press the numbered button.

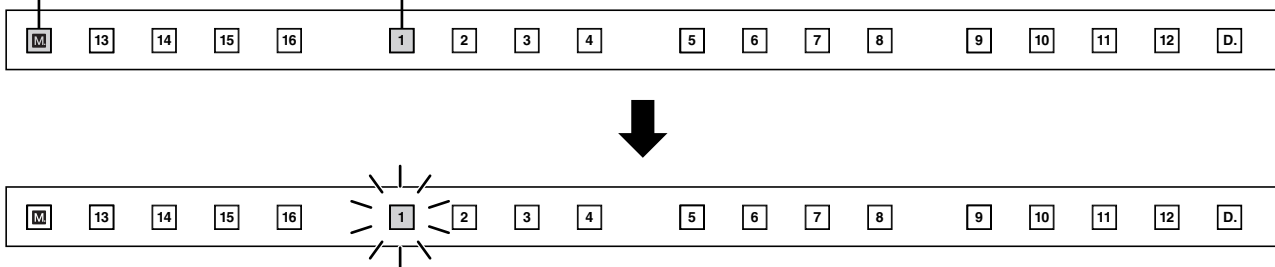

When the Registration is being stored, the [1] button flashes momentarily.

## M 2 Slightly Editing the Intro Sound

Here, we'll slightly change the Registration used in the intro (M1), by turning on the Lead Voice — to better bring out the melody played on the Upper keyboard.

**Press the (muted) Lead Voice 1 and Lead Voice 2 buttons in the Voice Display to turn them back on.**

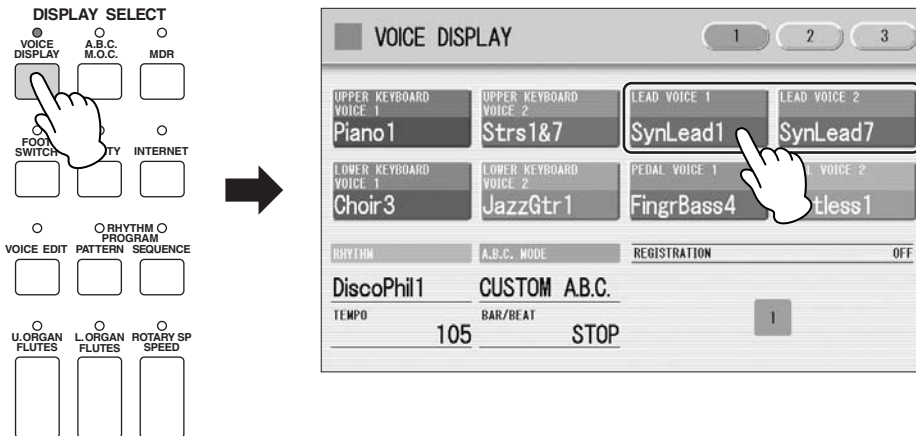

This completes the settings for Registration Memory 2, so record these settings to the [2] button in the Registration Memory section.

While holding down the [M.] (Memory) button in the Registration Memory section, press the [2] button.

1. While holding down [M.] button...

2. Press the numbered button.

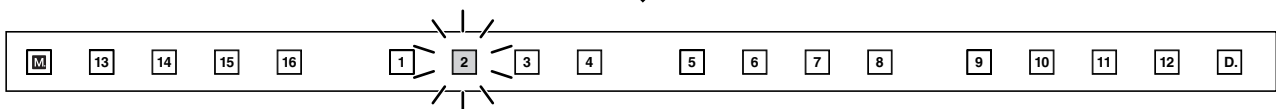

When the Registration is being stored, the [2] button flashes momentarily.



## M 3 Enjoying the Original Sound of the Registration Menu

For the main melody, we'll use original Registration Menu, with no editing. Melody On Chord is set to on for the Registration Menu by default, automatically adding harmony notes to your performance.

Press the REGISTRATION MENU [3] button, then select the “Disco Queen” Registration.

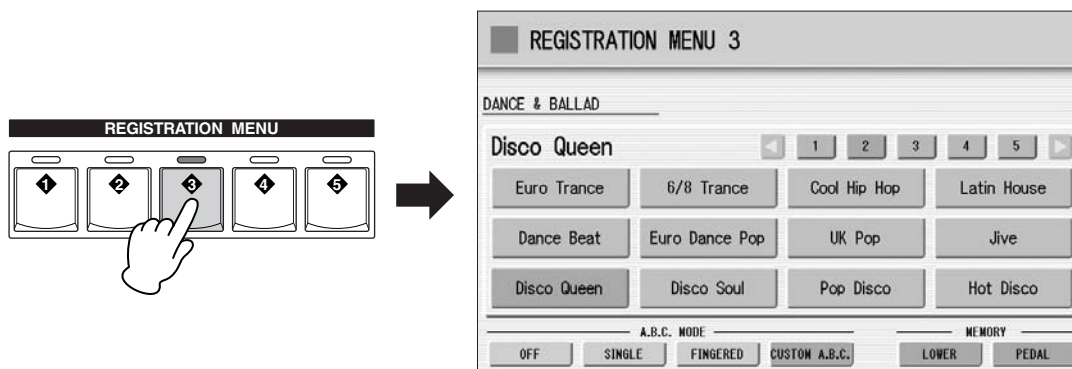

## Footswitch Settings

You can use the footswitches on the Electone to control different performance functions — without ever having to take your hands from the keyboards! First, we'll set the Left Footswitch function so that you can play the Ending 1 pattern with the left footswitch.

Press the [FOOT SWITCH] button to call up the Footswitch display, then press the [LEFT] button at the top right of the display.

Set the Mode to [RHYTHM], then select [ENDING 1] in the RHYTHM CONTROL section in the display.

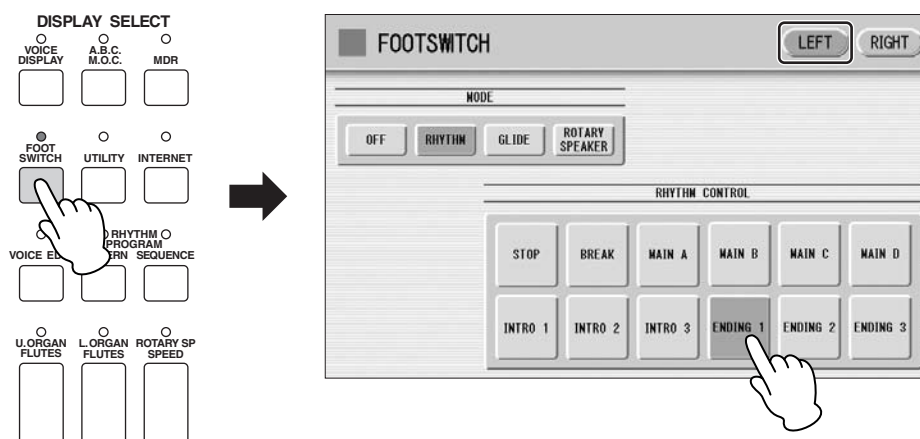

Next, set the Right Footswitch function so that you can change the Registration with the right footswitch.

**Press the [RIGHT] button at the top right of the display.**

Select the [SHIFT] mode as shown below.

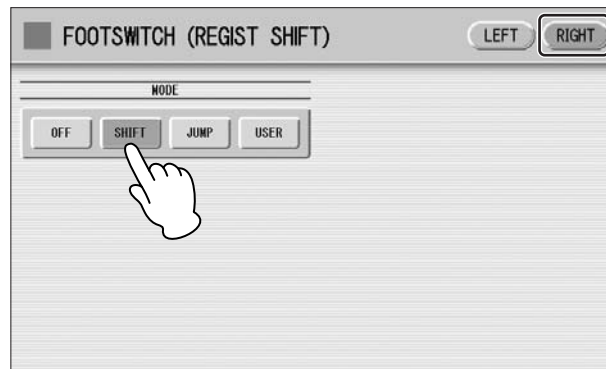

**NOTE** This setting, Registration Shift, cannot be saved to the Registration Memory buttons.

This completes the settings for Registration Memory 3, so record these settings to the [3] button in the Registration Memory section.

While holding down the [M.] (Memory) button in the Registration Memory section, press the [3] button.

1. While holding down [M.] button...

2. Press the numbered button.

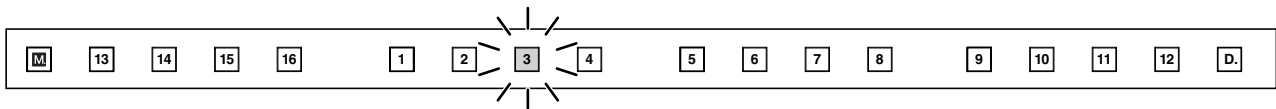
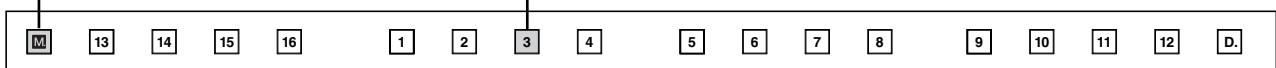

When the Registration is being stored, the [3] button flashes momentarily.

# Using the Music Data Recorder

In these instructions, you'll learn how to save your new Registration Memory settings to a USB flash memory.



## NOTE

Before purchasing any USB storage device, you should check with your Yamaha dealer or an authorized Yamaha distributor for advice on compatibility.

Before using an external media such as USB flash memory, carefully read "Precautions when using the USB TO DEVICE terminal" section on page 100.

## Saving Registration Data to USB flash memory

- 1 Insert a USB flash memory into the USB TO DEVICE terminal.

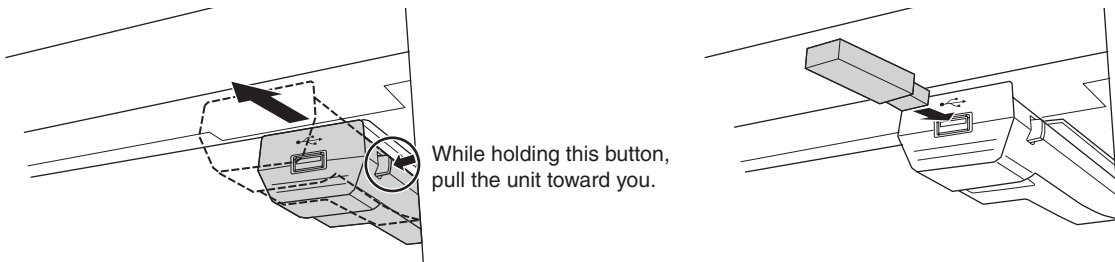

## NOTE

During your performance, make sure to slide the USB unit under the keyboard. If you leave it in the forward position, there is a danger of hitting it with your hand and breaking the USB device.

- 2 Press the [MDR] button in the panel to call up the M.D.R. display.  
In the SONG Page of the display, first press the [USB 01] button, then press the [IN] button.

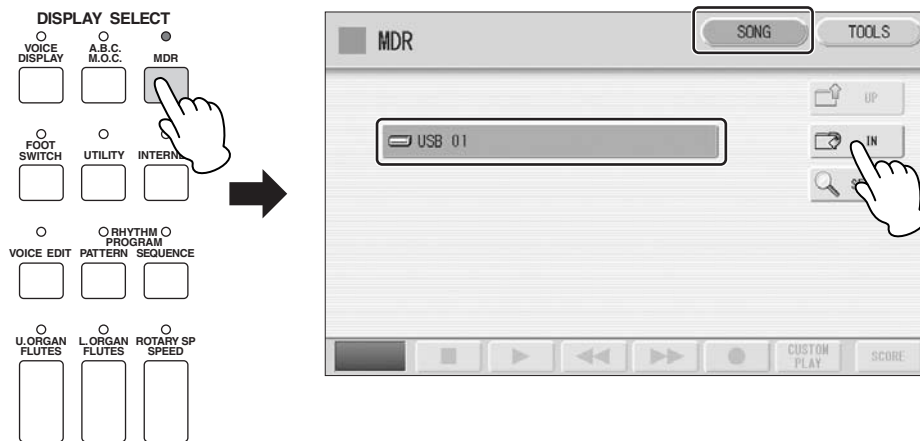

- 3 Select a blank Song to which the Registration data will be saved.

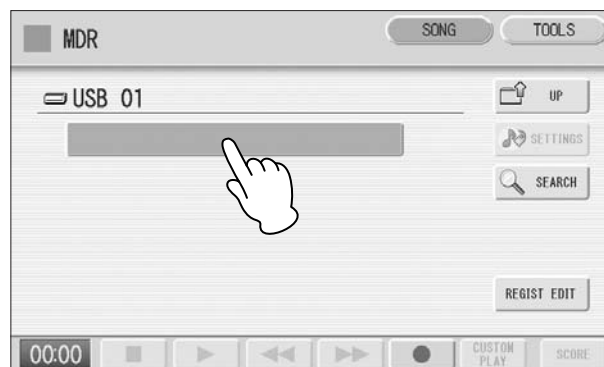

ACT 1

ACT 2

ACT 3

ACT 4

**4** Press the [REGIST EDIT] button in the display.

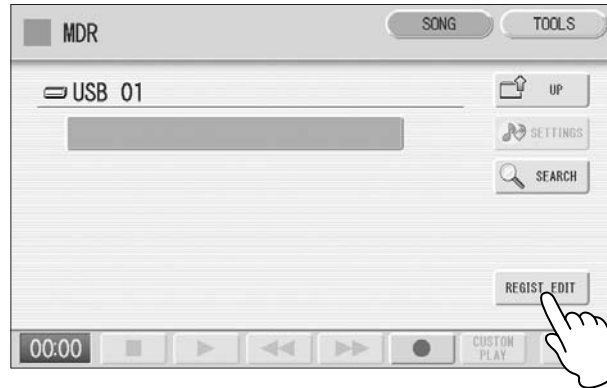

**5** Press the [SAVE] button in the display to save the Registration data. A message appears indicating the data is being saved. After the message disappears, press the [CLOSE] button to close the Regist Edit display.

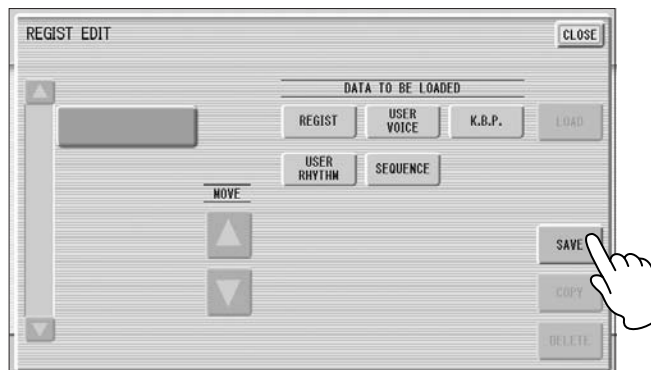

Now, your Registration settings in Registration Memory buttons 1 – 3 have been saved to a USB flash memory.

 **NOTE** You can change the Song name as desired (see page 108 in the Owner's Manual).

To call up the saved Registration data, select the song in the SONG Page of the M.D.R. display then press the [▶] (Play) button.



# Playing “Dancing Queen”

Using your three new Registrations (M1 – M3), try playing “Dancing Queen” now.

See the notation on pages 14 – 15. At the points in the score where M2 and M3 are indicated, press the right footswitch to change the Registration Memory. At the second to the last measure, press the left footswitch to switch to the Ending pattern and stop the rhythm. Using your foot to control these features may take some practice, but mastering this technique will make your performance much more dynamic and professional.

## 1 Press the Registration Memory [1] button.

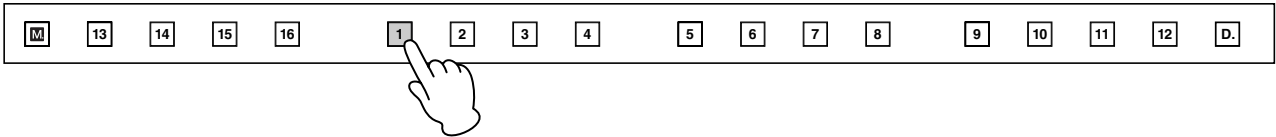

## 2 Press the INTRO [2] button on the panel.

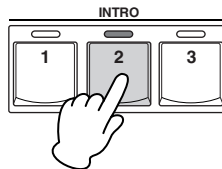

## 3 Press the rhythm [SYNCHRO START] button. The lamp above the BAR/BEAT display flashes, indicating the rhythm is set to standby.

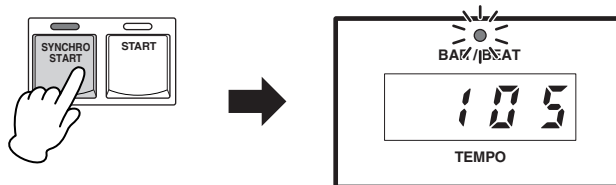

### NOTE

In the intro section, play the right hand performance with a soft touch, as if you were adding embellishments to the auto accompaniment. (If this part is difficult for you to play, feel free to ignore it.)



### NOTE

To better feel the disco rhythm with your whole body, play the pedalboard with four quarter notes every measure.

Now, start playing — in rhythm!

# ACT 3

## Selecting and Editing Voices Working with Rhythm Sequence and Registration Sequence

Song:  
Change the World

- M 1** Intro with Acoustic Guitar and Electric Piano
- M 2** Classic Rock Organ
- M 3** Sweet Harmonica Melody
- M 4** Soft Harmony with Pad Sound on the Lower Keyboard
- M 5** Mysterious Arpeggio with Delay
- M 6** Electric Guitar Solo
- M 7** Ending with Acoustic Guitar and Electric Piano

In Acts 1 and 2, you were able to enjoy playing the songs quickly using just the Registration Menu. However, you may want to spice up your performance with more detailed Voice settings.

In this chapter, we'll create custom song settings from the default settings. First, we'll select the necessary Voices and edit them with Voice controls and effects, then we'll program a Rhythm Sequence and Registration Sequence especially for the song.

After creating the song settings, try recording your performance to a USB flash memory with the M.D.R. function. The recorded song can be played back easily.

Since going through this chapter involves many different operations, take your time, master each step in turn while you familiarize yourself with the convenient, sophisticated functions of the Electone.

Here is a brief rundown of the seven Registrations you'll be using in "Change the World." The acoustic guitar and electric piano accompaniment form the main part for M1, a rock organ for M2, a sweet harmonica melody and pad harmony for M3 – M4, a mysterious arpeggio for M5, and an electric guitar solo for M6. The final, ending Registration, M7, has the same settings as the intro.



### Memo

#### About "Change the World"

This huge hit spent 13 weeks at #1 on both the Billboard and R&R charts in 1996 and captured three major Grammy awards in 1997: Song of the Year, Record of the Year and Best Male Pop Vocal Performance.

Though "Change the World" is closely identified with both Eric Clapton and Babyface, neither of those artists wrote the song. Moreover, the three acclaimed songwriters who actually composed the tune, wrote parts of it in turn and were not even in the same room together! The song was recorded first by country superstar Wynonna, and eventually found its way to Eric Clapton and Babyface, who performed and produced it for the soundtrack of the movie "Phenomenon."



# Initializing the Registration Memory

Before starting to create new song data, initialize the Registration Memory settings with the following procedure. This will erase the settings you made in the last chapter, but if you don't reset the Registrations, you won't get the intended results from the instructions that follow in this chapter.

**1** Press the [UTILITY] button on the panel.

**2** Press the INITIALIZE [EXECUTE] button in the Utility display, GLOBAL Page.

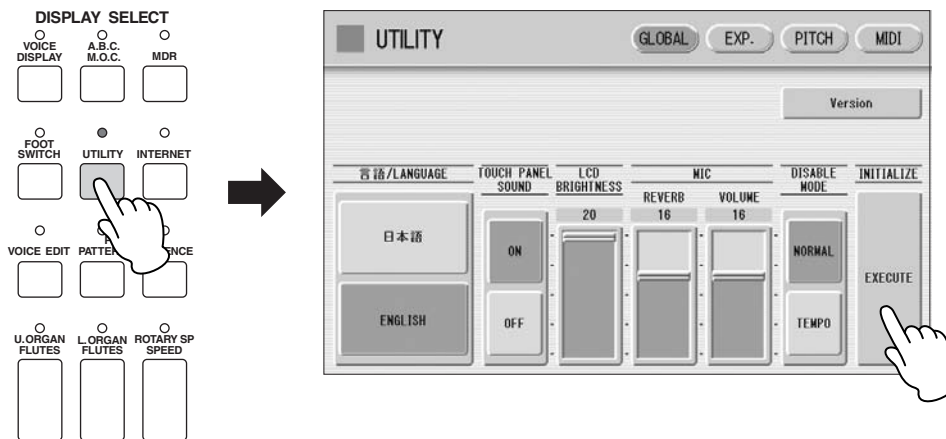

A message prompting you to initialize the Registration data appears. Press [INITIALIZE] to go ahead and initialize the data.

The display turns dark briefly, then starts up again automatically, indicating the initialization operation is complete.

## Creating the Registration Settings

How do go about creating the Registration? Where do you start? — the Voice settings for playing the melody, or the rhythm settings that determine the groove? Actually, either is fine. In these instructions, we'll first select the Voices for each keyboard, Upper, Lower and Pedal, then make the rhythm settings.



# M 1 Intro with Acoustic Guitar and Electric Piano

The main part of the Intro is the Acoustic Guitar and Electric Piano in the Lower Keyboard. In fact, the Electric Piano for Lower Keyboard Voice 2 is used throughout the song, contained in Registrations M1 – M7.

## Adjusting the Reverb Settings

- 1 Press one of the REVERB buttons on the panel to call up the Reverb Display, and set the Depth to 20.

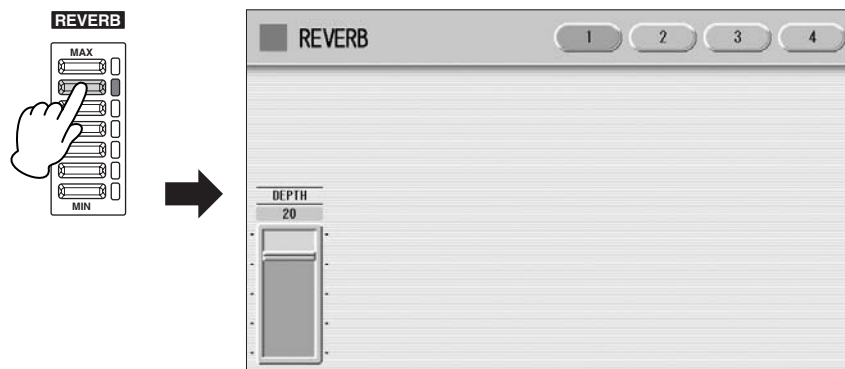

- 2 Press the [2] button at the top right of the display, then set the Type to [STAGE 1]. Pressing the TYPE button calls up the Effect Type list. Select [STAGE 1] from the list.

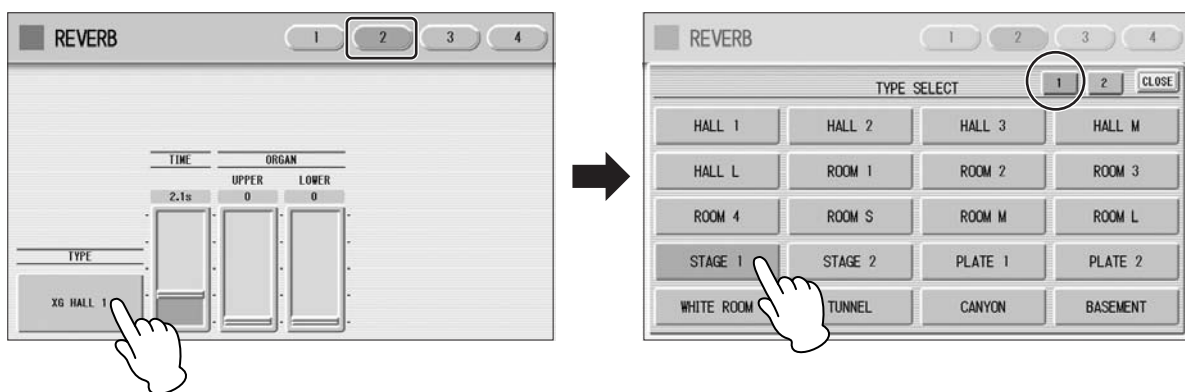

This setting reproduces the intimate atmosphere of hearing a live performance on a small stage, instead of a large hall.



### NOTE

The sliders in Page 3 of the Reverb display are the same as the Reverb slider in the Voice Condition display of each Voice section. In these instructions, we'll adjust the reverb for each Voice section by using the Reverb Slider in the Voice Condition display, not the Reverb display.

- 3** Press the [4] button at the top right of the display, then set the Type to [STAGE 1] and the Accompaniment to 20, as shown below.

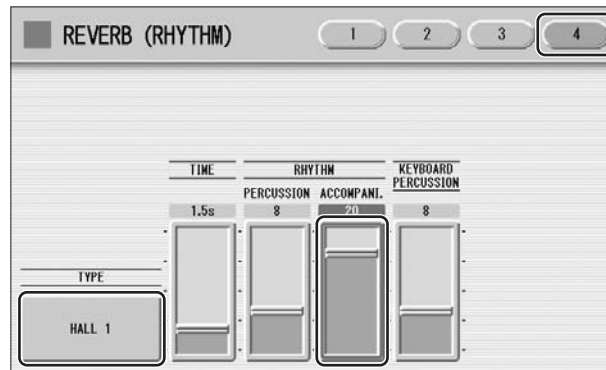

### Helpful Hint

The reverb for this song should be relatively short and minimal, especially since a “dry” percussion sound better suits the intimate nature of the song. If you want to play a brass sound, a short, tight reverb is better, too. On the other hand, when playing strings, or an expressive solo instrument, make the reverb settings deeper and longer to reproduce a larger hall atmosphere and bring out the subtle nuances of the instrument.

## Selecting and Editing the Upper Keyboard Voices

- 1** Press the [ORGAN] button in the UPPER KEYBOARD VOICE 1 section.

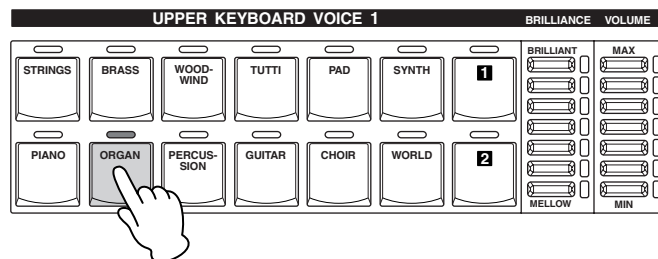

- 2** Select [Rock Organ 1] in the displayed Voice Menu, on display Page 4.

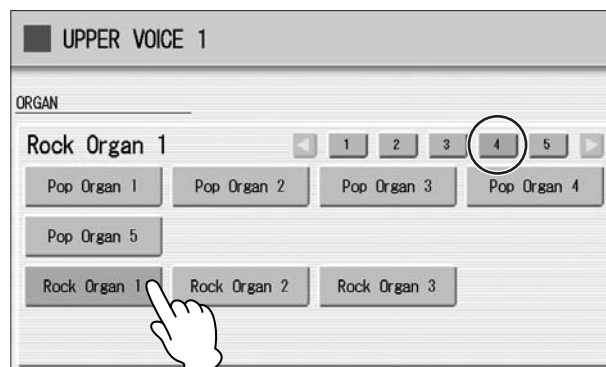

- 3** Set the **BRILLIANCE** button (at the right of the Voice buttons), to the third position from the top.

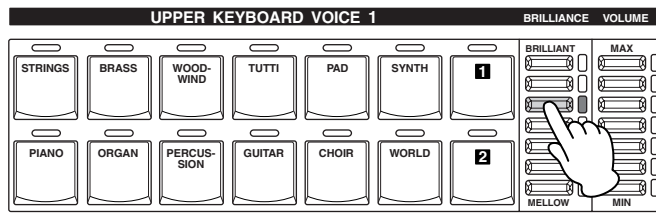

- 4** Make the appropriate Voice Condition settings for Rock Organ 1. Pressing the [ORGAN] button on the panel again calls up the Voice Condition display. On Page 1 of the display, set After Touch in Touch Tone to 0, and Reverb to 16.



On Page 2 of the display, set Tune to +4. (Use the Data Control dial, if necessary.) This detunes the sound slightly and gives it a bit of tension.

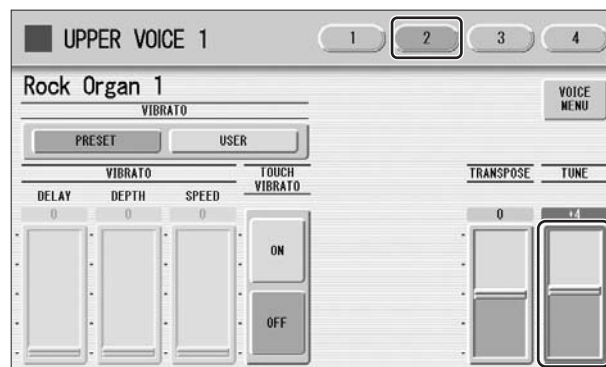

**NOTE** There are two ways to call up the Voice Condition display: pressing the same Voice button on the panel again, or pressing the selected Voice button in the Voice Menu in the display. In these instructions, we've used the first method.



**NOTE** The VOLUME buttons on the panel let you make broad settings to the volume, while the VOLUME slider in the Voice Condition display lets you make fine adjustments.

## 5 On Page 3 of the display, select the Effect Category and Type.

Pressing the EFFECT1 button calls up the Effect Category list. Select [ROTARY SPEAKER] from the list.

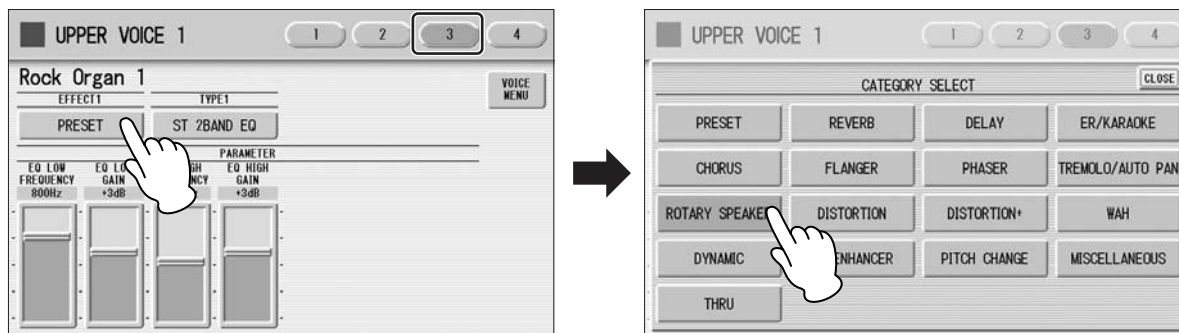

Pressing the TYPE1 button calls up the Effect Category list. Select [ROTARY SP 5] from the list.

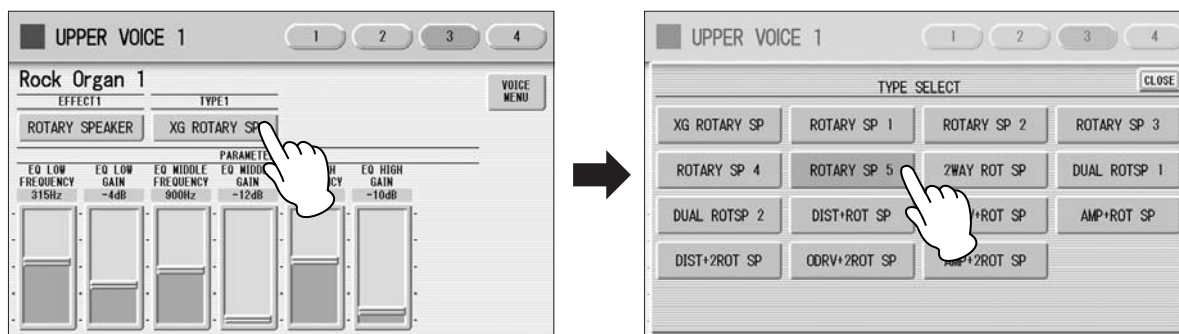

### NOTE

After you've changed the Effect Type, the effect parameters at the bottom half of the display automatically change as well to reflect the switch. Feel free to adjust these effect parameters as you want to get the desired sound.

Set the EQ High Gain to +7dB.

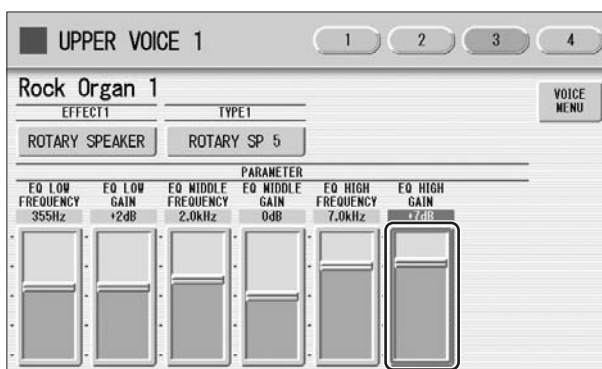

### **Helpful Hint**

Press the [ROTARY SP SPEED] button on the panel to turn the Rotary Speaker on/off at the respective points indicated in the notation ( **A** and **D** ).

You can do this with your right hand, while you play. At the end of the glissando (the note F), keep holding the note with your finger and replace it with your thumb. While you continue to hold the key, press the [ROTARY SP SPEED] button with forefinger or middle finger.

- 6 On Page 4 of the display, change EFFECT 2 to THRU.**  
The Effect Type (TYPE 2) also changes to THRU automatically.

This completes the settings for UPPER KEYBOARD VOICE 1.

For the M1 Registration, UPPER KEYBOARD VOICE 2, LEAD VOICE 1 and LEAD VOICE 2 are not used. Turn all their volume settings to 0.

## Selecting and Editing the Lower Keyboard Voices

- 1 Press the [GUITAR] button in the LOWER KEYBOARD VOICE 1 section.**
- 2 Select [Steel Guitar 1] in the displayed Voice Menu, on display Page 1.**
- 3 Check that the BRILLIANCE button (at the right of the Voice buttons), is set to the fourth position from the top.**
- 4 Make the appropriate Voice Condition settings for Steel Guitar 1.**  
On Page 1 of the Voice Condition display, set After Touch in Touch Tone to 0, and Volume to 22.



You don't need to make any changes in Pages 2 and 3 of the Voice Condition display.

## 5 On Page 4 of the display, change EFFECT 2 to THRU.

This completes the settings for LOWER KEYBOARD VOICE 1. Next, we'll edit the LOWER KEYBOARD VOICE 2 settings.

## 6 Press the [PIANO] button in the LOWER KEYBOARD VOICE 2 section.

## 7 Select [Stage E.Piano 1] in the displayed Voice Menu, on display Page 2.

## 8 Set the BRILLIANCE button (at the right of the Voice buttons), to the third position from the top.

## 9 Make the appropriate Voice Condition settings for Stage E.Piano 1.

On Page 1 of the Voice Condition display, set Initial Touch in Touch Tone to 5, and After Touch to 0. Also, set Volume to 22, and Pan to L1 (one step left of center).



This Pan setting places the Electric Piano on the left side of the stage.

You don't need to make any changes in Page 2 of the Voice Condition display.

## 10 On Page 3 of the display, change EFFECT 1 to CHORUS and TYPE 1 to CELESTE 4.

You don't need to make any changes in Page 4 of the Voice Condition display.

This completes the settings for the Lower Keyboard Voices.

## Selecting and Editing the Pedal Voices

- 1 Press the [ELEC. BASS] button in the PEDAL VOICE 1 section.
- 2 Select [Fingered Bass 1] in the displayed Voice Menu, on display Page 1.
- 3 Set the BRILLIANCE button (at the right of the Voice buttons), to the second position from the top.

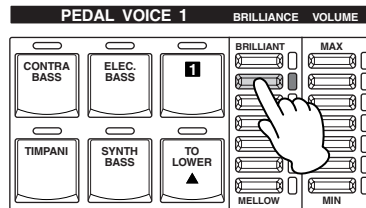

- 4 Make the appropriate Voice Condition settings for Fingered Bass 1.  
On Page 1 of the Voice Condition display, set Initial Touch in Touch Tone to 4, and After Touch to 0. (After Touch for the Pedal Voice is available only on the ELS-01C). Also, set the Volume to 17.

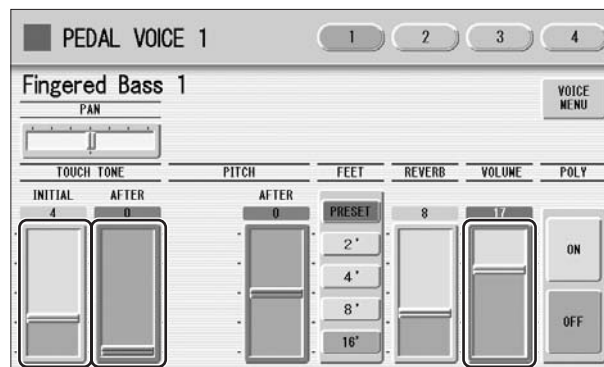

You don't need to make any changes in Pages 2, 3 and 4 of the Voice Condition display.

This completes the settings for PEDAL VOICE 1. Next, we'll edit the PEDAL VOICE 2 settings.

- 5 Press the [ELEC. BASS] button in the PEDAL VOICE 2 section.
- 6 Select [Fretless Bass 1] in the displayed Voice Menu, on display Page 2.
- 7 Set the BRILLIANCE button (at the right of the Voice buttons), to the third position from the top. Also, set the VOLUME button to the third position from the bottom.

## 8 Make the appropriate Voice Condition settings for Fretless Bass 1.

On Page 1 of the Voice Condition display, set Initial Touch in Touch Tone to 5, and After Touch to 0. (After Touch for the Pedal Voice is available only on the ELS-01C).

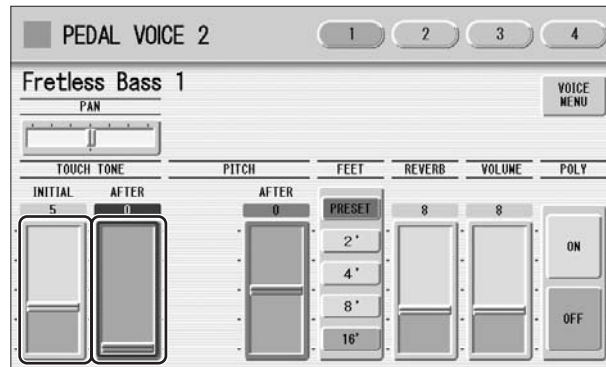

You don't need to make any changes in Page 2 of the Voice Condition display.

## 9 On Page 3 of the display, change the EFFECT 1 to [CHORUS] and TYPE 1 to [XG CHORUS 1].

You don't need to make any changes in Page 4 of the Voice Condition display.

This completes the settings for the Pedal Voice settings.

## Editing the Rhythm Condition

### 1 Press the [POPS] button on the panel.

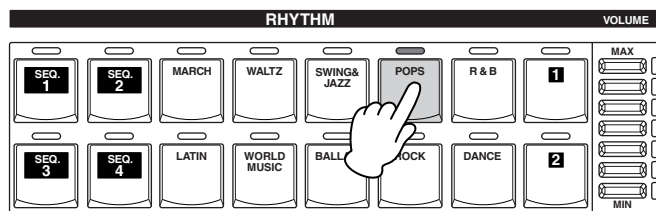

### 2 Select the [60's 8Beat] in the displayed Rhythm Menu, on display Page 1.

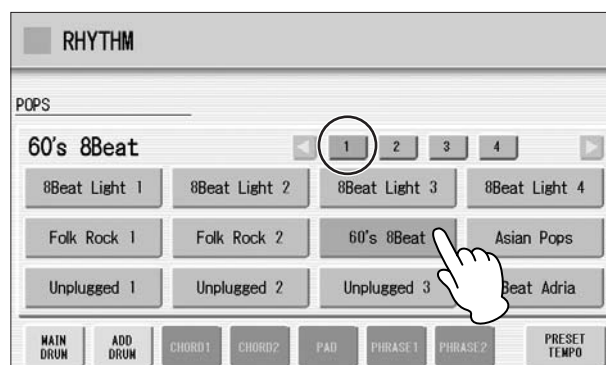



- 3 Set the **VOLUME** button, (at the right of the Rhythm buttons), to the second position from the top.

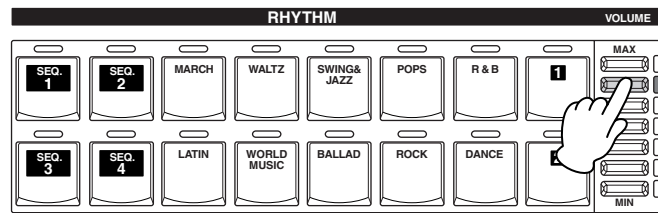

Turn the **TEMPO** dial and set the Tempo to 106.

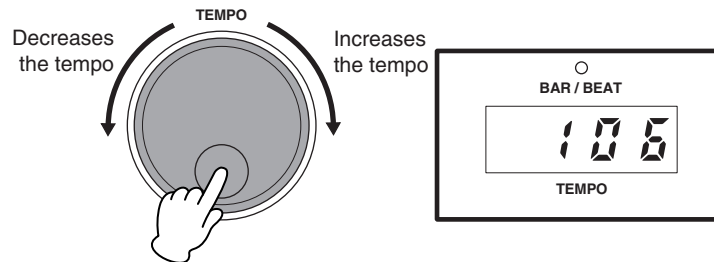

**NOTE**

In this song, the rhythm patterns will automatically be changed with the Rhythm Sequence, so you don't need to save your rhythm pattern selections to Registration Memory. However, the Tempo and Rhythm Condition settings must be saved to Registration Memory.

This completes the Rhythm Condition settings.

Now that the Registration Memory 1 settings are complete, record them to the [1] button in Registration Memory section.

**While holding down the [M.] (Memory) button in the Registration Memory section, press the [1] button.**

When the Registration is being stored, the [1] button flashes momentarily.

Working through the instructions above, you've probably become quite familiar with making settings for Voice Condition and Rhythm Condition. Now try making settings on your own for the other Registration Memories (M2 – M7), referring to the list of Voice Condition settings below.

# M 2 Classic Rock Organ

Using the M1 Registration as a basis, make M2 by changing the Lower Keyboard Voice setting. The “Resonance Pad 5” Voice we’ll set here for Lower Keyboard Voice 1 is a unique sound that includes an interval of a fifth, making chords played on the Lower Keyboard sound rich and mysterious.

## Changing Lower Keyboard Voice 1

### 1 Select the [Resonance Pad 5] Voice for the Lower Keyboard Voice 1.

This Voice is included in the [PAD] button, display Page 2.

### 2 Make the appropriate Voice Condition settings for Resonance Pad 5.

Change the Voice Condition settings in display Pages 1 – 4 and the Brilliance setting according to the following chart. Settings/values that should be changed are highlighted in color.

#### Voice Condition Settings

Page 1	Pan	Center	
	Touch Tone	Initial: 3	After: 12
	Pitch	Horizontal: 0	After: 0
	Feet	Preset (8')	
	Reverb	20	
	Volume	20	
Page 2	Vibrato	Preset	
	Touch Vibrato	OFF	
	Transpose	0	
	Tune	0	
Page 3	Effect 1	Chorus	
	Type 1	Celeste 2	
Page 4	Effect 2	Thru	
	Type 2	Thru	
BRILLIANCE		3rd from bottom	

The After Touch setting allows you to change the volume and timbre of the sound, depending on how strongly you press down on the keys after playing them.

After you’ve made all the necessary Voice Condition settings, press the [ROTARY SP SPEED] button to turn it on.

Now that the Registration Memory 2 settings are complete, record these settings to the [2] button in Registration Memory section.

# M 3 Sweet Harmonica Melody

Using the M1 Registration as the basis, set Harmonica for Lead Voice 1.

First, call up the M1 Registration by pressing the [1] button on the Registration Memory section, then set the volume of the Upper Keyboard Voice 1 to 0.

## Creating the Lead Voice 1 settings

- 1 Press User button [1] of Lead Voice 1, then select [Harmonica 2] from the Organ category.

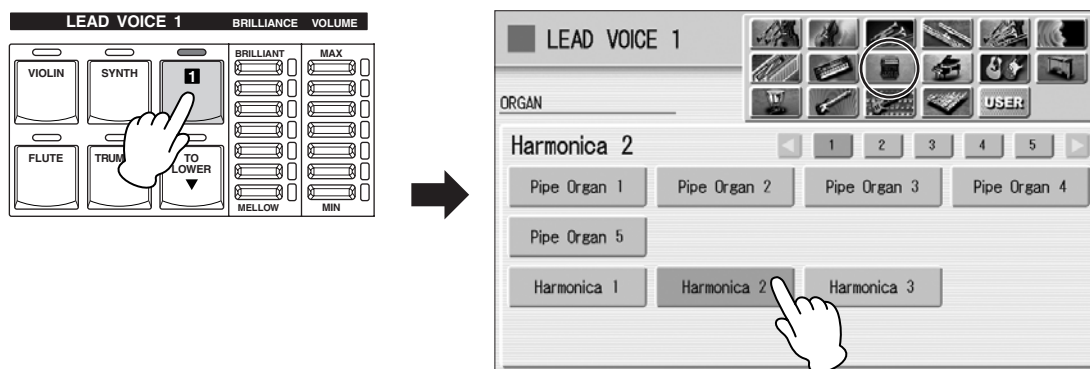

- 2 Make the appropriate Voice Condition settings for Harmonica 2. Change the Voice Condition settings in display Pages 1 – 4 and the Brilliance setting according to the following chart. Settings/values that should be changed are highlighted in color.

### Voice Condition Settings

Page 1	Pan	Center	
	Touch Tone	Initial: 8	After: 8
	Pitch	Horizontal: 0	After: 0
	Feet	Preset (8')	
	Reverb	18	
	Volume	22	
Page 2	Vibrato	User	Delay: 4, Depth: 2, Speed: 3
	Touch Vibrato	OFF	
	Slide	OFF	Time: 0
	Transpose	0	
	Tune	+10	
Page 3	Effect 1	Delay	
	Type 1	Echo	
Page 4	Effect 2	Preset	
	Type 2	Thru	
BRILLIANCE		4th from bottom	

ACT 1

ACT 2

ACT 3

ACT 4

The “User” setting of Vibrato allows you to create your original vibrato by changing the vibrato delay, depth and speed. The Tune setting, set higher than other Voices, makes the Harmonica stand out. The Delay effect lends an echo to the sound as if the instrument is being played in a hall.

This completes the LEAD VOICE 1 settings.

LEAD VOICE 2 is not going to be used in this Registration, so check that its volume is set to 0.

Now that the Registration Memory 3 settings are complete, record these settings to the [3] button in Registration Memory section.

ACT 1

ACT 2

ACT 3

ACT 4

## M 4 Soft Harmony with Pad Sound on the Lower Keyboard

Using the M3 Registration as the basis, set Pop Lead for Lead Voice 2 and change the Lower Keyboard Voice 1 to an ethereal pad sound like an angel singing. We'll also change the Rhythm Condition here, setting some accompaniment parts – including guitar backing – to on.

First call up the M3 Registration by pressing the [3] button on the Registration Memory section.

### Helpful Hint

If you don't want to program all of the Registration settings in one session, it is a good idea to save the Registration settings you've created to a USB flash memory, using the M.D.R. function. Saving your settings periodically will also help prevent loss of data should you make any mistakes while programming.

When you want to create a new Registration based on the previously created Registration, first call up the created Registration (M3, in this case) then record it to the Registration memory number to be re-programmed (M4, in this case). This helps your programming and editing go more smoothly.

## Creating the Lead Voice 2 settings

- 1 Press User button [1] of Lead Voice 2, then select [Pop Lead 6] from the Synth category, display Page 2.

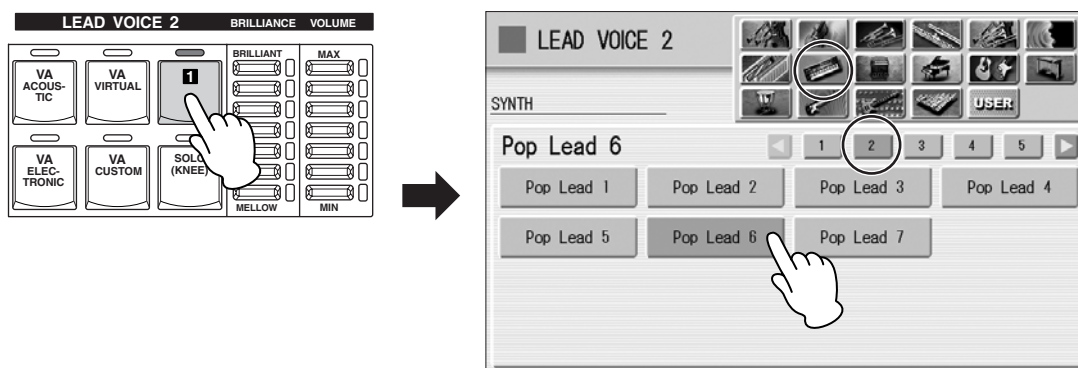

# 2

## Make the appropriate Voice Condition settings for Pop Lead 6.

Change the Voice Condition settings in display Pages 1 – 4 and the Brilliance setting according to the following chart. Settings/values that should be changed are highlighted in color.

### Voice Condition Settings

Page 1	Pan	Center	
	Touch Tone	Initial: 8	After: 8
	Pitch	Horizontal: 0	After: 0
	Feet	Preset (8')	
	Reverb	22	
	Volume	12	
	Priority	Last	
Page 2	Vibrato	Preset	
	Touch Vibrato	OFF	
	Slide	OFF	Time: 0
	Transpose	0	
	Tune	+10	
Page 3	Effect 1	Delay	
	Type 1	Delay LR	
Page 4	Effect 2	Thru	
	Type 2	Thru	
BRILLIANCE		3rd from top	



#### NOTE

The “Last” setting of the Priority parameter allows you to play the phrase with the Lead Voice while one note is being held down — for example, in the fourth and seventh bars in in the notation.

This completes the LEAD VOICE 2 settings.

## Changing the Lower Keyboard settings

### 1 Select [Smooth Pad 1] for Lower Keyboard Voice 1.

This Voice is included in the [PAD] button, display Page 1.

### 2 Make the appropriate Voice Condition settings for Smooth Pad 1.

Change the Voice Condition settings in display Pages 1 – 4 and the Brilliance setting according to the following chart. Settings/values that should be changed are highlighted in color.

**Voice Condition Settings**

Page 1	Pan	Center	
	Touch Tone	Initial: 8	After: 0
	Pitch	Horizontal: 0	After: 0
	Feet	Preset (8')	
	Reverb	20	
	Volume	12	
Page 2	Vibrato	Preset	
	Touch Vibrato	OFF	
	Transpose	0	
	Tune	0	
Page 3	Effect 1	EQ/Enhancer	
	Type 1	ST 2Band EQ	
Page 4	Effect 2	Thru	
	Type 2	Thru	
BRILLIANCE		4th from bottom	

### 3 Press the SUSTAIN [LOWER] button to call up the Sustain Length display. Set the sustain length of LOWER1 to 4, and LOWER2 to 0.

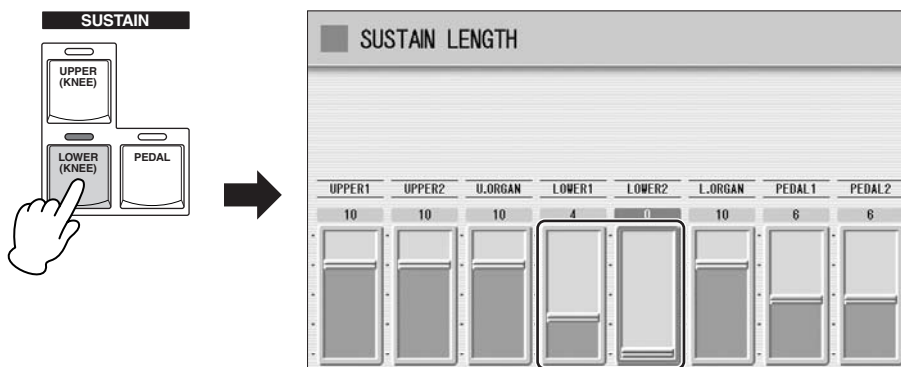

#### NOTE

The Smooth Pad 1 Voice sounds long after you release your finger from the key. Reducing the sustain length makes this decay shorter.

## Changing the Rhythm Condition settings

- 1 Press the [POPS] button and select [16Beat 1] from display Page 3.
- 2 Turn on two of accompaniment parts, Chord 1 and Pad by pressing the [CHORD1] and [PAD] buttons shown at the bottom of the display.

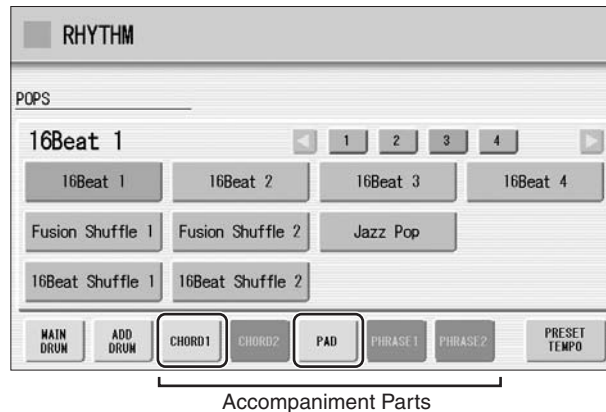

- 3 Press the [POPS] button on the panel again to call up the Rhythm Condition display, then increase the Accompaniment Volume to 18.

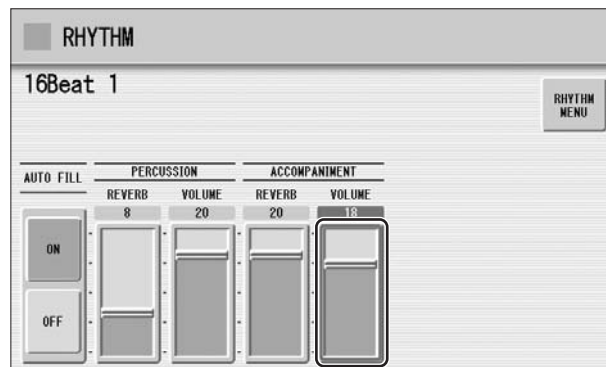

This completes the Rhythm Condition settings.

Now that the Registration Memory 4 settings are complete, record these settings to the [4] button in Registration Memory section.



# M 5 Mysterious Arpeggio with Delay

Using the M2 Registration as the basis, we'll change the Upper Keyboard Voices 1 and 2. Also, for playing the arpeggio, we'll use the Delay effect.

First call up the M2 Registration by pressing the [2] button on the Registration Memory section, then press the [ROTARY SP SPEED] button to turn it off.

## Changing the Upper Keyboard Voice Settings

### 1 Select [DX E.Piano 2] for Upper Keyboard Voice 1.

This Voice is included in the [PIANO] button, display Page 2.

### 2 Make the appropriate Voice Condition settings for DX E.Piano 2.

Change the Voice Condition settings in display Pages 1 – 4 and the Brilliance setting according to the following chart. Settings/values that should be changed are highlighted in color.

#### Voice Condition Settings

Page 1	Pan	L1	
	Touch Tone	Initial: 4	After: 0
	Pitch	Horizontal: 0	After: 0
	Feet	Preset (8')	
	Reverb	22	
	Volume	20	
Page 2	Vibrato	Preset	
	Touch Vibrato	OFF	
	Transpose	0	
	Tune	0	
Page 3	Effect 1	Chorus	
	Type 1	Celeste 4	
Page 4	Effect 2	Thru	
	Type 2	Thru	
BRILLIANCE		4th from bottom	

This completes the UPPER KEYBOARD VOICE 1 settings. Next, we'll edit the UPPER KEYBOARD VOICE 2 settings.

### 3 Select [DX E.Piano 2] for Upper Keyboard Voice 2.

This Voice is included in the [PIANO] button, display Page 2.

## 4 Make the appropriate Voice Condition settings for DX E.Piano 2.

Change the Voice Condition settings in display Pages 1 – 4 and the Brilliance setting according to the following chart. Settings/values that should be changed are highlighted in color.

### Voice Condition Settings

Page 1	Pan	Center	
	Touch Tone	Initial: 4	After: 0
	Pitch	Horizontal: 0	After: 0
	Feet	4'	
	Reverb	24	
	Volume	22	
Page 2	Vibrato	Preset	
	Touch Vibrato	OFF	
	Transpose	0	
	Tune	0	
Page 3	Effect 1	Chorus	
	Type 1	Celeste 4	
Page 4	Effect 2	Delay	
	Type 2	Tempo Delay	Delay Time: 4th/3, Feedback Level: +16, Dry/Wet: D<W63
BRILLIANCE		3rd from top	



**NOTE** Tempo Delay creates delayed notes to embellish a phrase. In this song, once you play the notes G, B, D and F, other notes you have not played will follow — thanks to the delay.



## 5 Press the SUSTAIN [UPPER] button to call up the Sustain Length display. Set the sustain length of both UPPER1 and UPPER2 to 8.

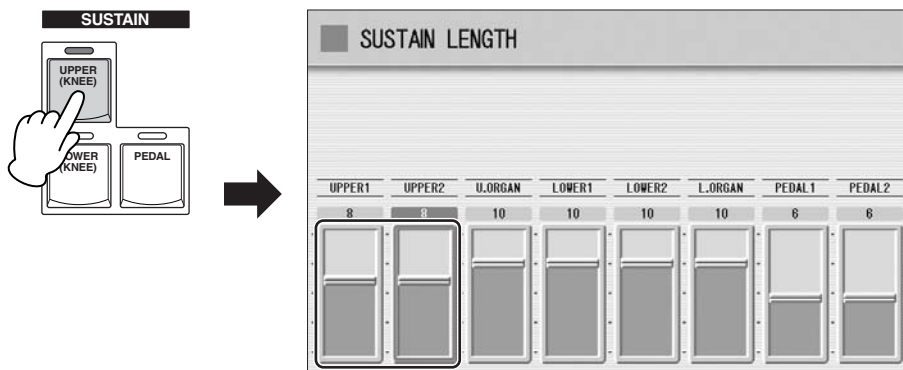

Now that the Registration Memory 5 settings are complete, record these settings to the [5] button in Registration Memory section.

# M 6 Electric Guitar Solo

Using the M5 Registration as the basis, change the Upper Keyboard Voice 2 and Lower Keyboard Voice 1. The main Voice in this Registration is Electric Guitar. Here, we'll create an exciting distorted electric guitar sound.

First, turn the Upper Keyboard Voice 1 volume to 0, then press the SUSTAIN [UPPER] button to turn Sustain off.

## Changing the Upper Keyboard Voice settings

### 1 Select [Elec Guitar 2] for Upper Keyboard Voice 2.

This Voice is included in the [GUITAR] button, display Page 2.

### 2 Make the appropriate Voice Condition settings for Elec Guitar 2.

Change the Voice Condition settings in display Pages 1 – 4 and the Brilliance setting according to the following chart. Settings/values that should be changed are highlighted in color.

#### Voice Condition Settings

Page 1	Pan	Center	
	Touch Tone	Initial: 8	After: 8
	Pitch	Horizontal: 6	After: -9
	Feet	8'	
	Reverb	22	
	Volume	24	
Page 2	Vibrato	User	Delay: 3, Depth: 3, Speed: 1
	Touch Vibrato	OFF	
	Transpose	0	
	Tune	+8	
Page 3	Effect 1	Distortion+	
	Type 1	Dist.+Delay	
Page 4	Effect 2	Thru	
	Type 2	Thru	
BRILLIANCE		4th from bottom	

The adjusted Tune setting gives the sound a certain amount of tension.

Horizontal and After Touch lets you change the volume and timbre of the sound by your performance technique on the Upper keyboard.



**NOTE** Horizontal Touch is available only on the ELS-01C.

This completes the UPPER KEYBOARD VOICE 2 settings.

## Changing the Lower Keyboard Voice settings

### 1 Select [Pop Organ 4] for Lower Keyboard Voice 1.

This Voice is included in the [ORGAN] button, display Page 4.

### 2 Make the appropriate Voice Condition settings for Pop Organ 4.

Change the Voice Condition settings in display Pages 1 – 4 and the Brilliance setting according to the following chart. Settings/values that should be changed are highlighted in color.

#### Voice Condition Settings

Page 1	Pan	Center	
	Touch Tone	Initial: 8	After: 0
	Pitch	Horizontal: 0	After: 0
	Feet	Preset (8')	
	Reverb	16	
	Volume	12	
Page 2	Vibrato	Preset	
	Touch Vibrato	OFF	
	Transpose	0	
	Tune	0	
Page 3	Effect 1	Preset	
	Type 1	ST 2Band EQ	
Page 4	Effect 2	Thru	
	Type 2	Thru	
BRILLIANCE		4th from bottom	

Now that the Registration Memory 6 settings are complete, record these settings to the [6] button in Registration Memory section.

# M 7 Ending with Acoustic Guitar and Electric Piano

Using the M1 Registration as the basis, create the Registration for the ending. This will let you finish the song with a sparse, calm arrangement of guitar and piano.

First, call up the M1 Registration by pressing the [1] button in the Registration Memory section.

## Changing the Upper Keyboard Voice settings

### 1 Select [Steel Guitar 1] for Upper Keyboard Voice 1.

This Voice is included in the [GUITAR] button, display Page 1.

### 2 Make the appropriate Voice Condition settings for Steel Guitar 1.

Change the Voice Condition settings in display Pages 1 – 4 and the Brilliance setting according to the following chart. Settings/values that should be changed are highlighted in color.

#### Voice Condition Settings

Page 1	Pan	Center	
	Touch Tone	Initial: 8	After: 0
	Pitch	Horizontal: 0	After: 0
	Feet	Preset (16')	
	Reverb	20	
	Volume	22	
Page 2	Vibrato	Preset	
	Touch Vibrato	OFF	
	Transpose	0	
	Tune	0	
Page 3	Effect 1	Preset	
	Type 1	ST2Band EQ	
Page 4	Effect 2	Thru	
	Type 2	Thru	
BRILLIANCE		4th from bottom	

This completes the UPPER KEYBOARD VOICE 1 settings. Next, we'll edit the UPPER KEYBOARD VOICE 2 settings.

### 3 Select [Stage E.Piano 1] for Upper Keyboard Voice 2.

This Voice is included in the [PIANO] button, display Page 2.

# 4

## Make the appropriate Voice Condition settings for Stage E.Piano 1.

Change the Voice Condition settings in display Pages 1 – 4 and the Brilliance setting according to the following chart. Settings/values that should be changed are highlighted in color.

### Voice Condition Settings

Page 1	Pan	L1	
	Touch Tone	Initial: 5	After: 0
	Pitch	Horizontal: 0	After: 0
	Feet	16'	
	Reverb	20	
	Volume	15	
Page 2	Vibrato	Preset	
	Touch Vibrato	OFF	
	Transpose	0	
	Tune	0	
Page 3	Effect 1	Chorus	
	Type 1	Celeste 4	
Page 4	Effect 2	Preset	
	Type 2	Thru	
BRILLIANCE		4th from bottom	

This completes the Upper Keyboard settings.



#### NOTE

The only difference between the Upper Keyboard Voices and Lower Keyboard Voices is the Feet (octave) setting.

Now that the Registration Memory 7 settings are complete, record these settings to the [7] button in Registration Memory section.

# Recording a Rhythm Sequence Program

Using the powerful Rhythm Sequence Program feature, you can string together any of the Electone's rhythms to make complete rhythm compositions. In this section, we'll connect some preset rhythms to make the rhythm composition for "Change the World." The rhythms used in this song are shown in the notation on pages 26 – 27.

## Selecting a Sequence

- 1 Press the [SEQUENCE] button in the DISPLAY SELECT section.

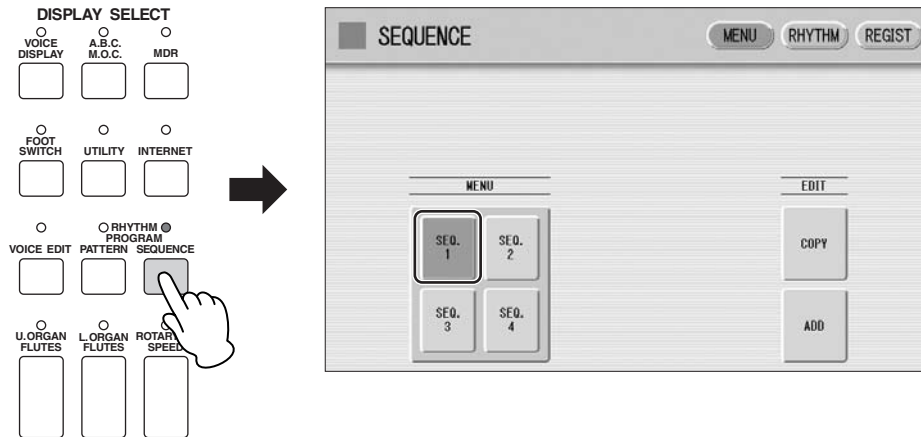

The Sequence display appears and the destination, [SEQ.1] (Sequence 1), is selected.

- 2 Press the [RHYTHM] button at the top right of the display to call up the RHYTHM Page.

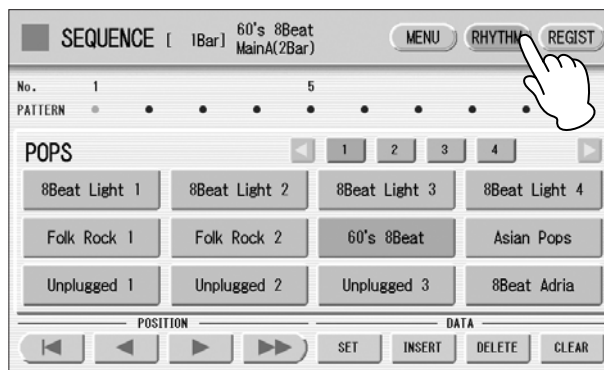

ACT 1

ACT 2

ACT 3

ACT 4

# Programming the Rhythm Sequence

First, we'll set the Intro 1 section of the 60's 8Beat rhythm for the first measure.

- 1 Press the [POPS] button in the RHYTHM section on the panel.

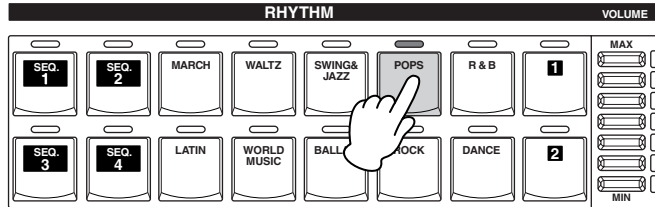

- 2 Select [60's 8Beat] from the displayed rhythm menu. The selected rhythm is shown at the top of the display.

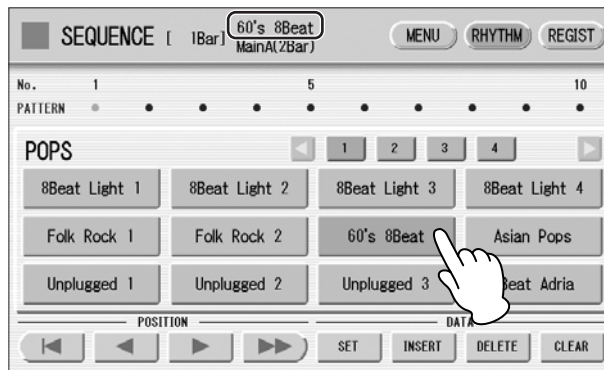

- 3 Press the INTRO [1] button to turn Intro 1 on.

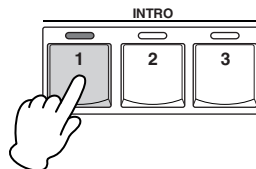

**NOTE** When the Intro, Ending, or Break section is selected, the MAIN/FILL IN button flashes.



- 4 Enter the selected rhythm “60’s 8Beat, Intro 1” to the first bar by pressing the [SET] button in the display.

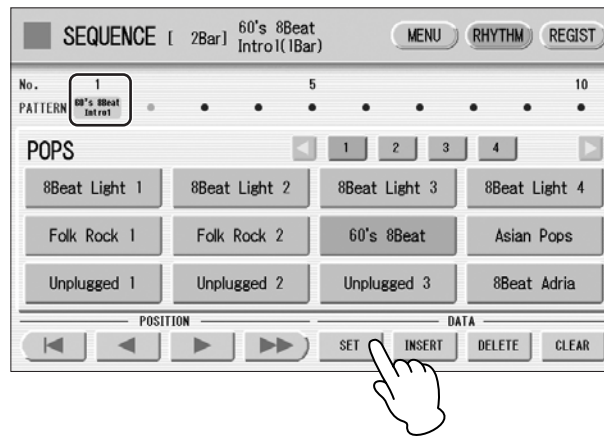

**NOTE** Once the [SET] button is pressed, one measure of the selected rhythm will be entered. The exception to this rule is the ending patterns, which enter more than one measure when you press the [SET] button. Keep in mind that entering an ending pattern automatically ends the song; no other rhythms can be entered after an ending pattern.

Next, set the Main A section of the 8Beat Light 1 rhythm, for the second bar.

- 5 Press the [POPS] button on the panel and select [8Beat Light 1] from the displayed rhythm menu.

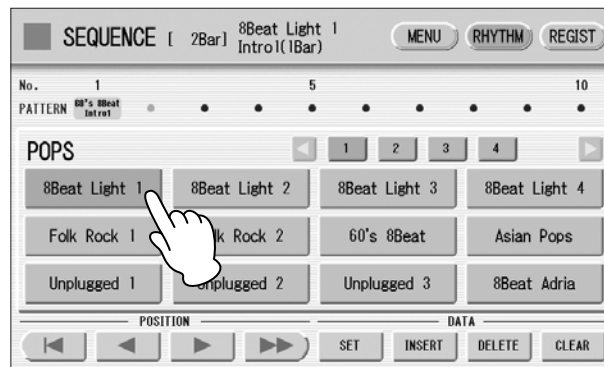

- 6 Press the MAIN/FILL IN [A] button twice so that the [A] button lights (not flashes).

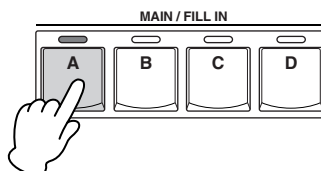

**NOTE** When you press the [A] button once, the button flashes and Fill In A is selected. Pressing it again lights the [A] button and Main A is selected.

**7** Enter the selected rhythm “8Beat Light 1, Main A” to the second bar by pressing the [SET] button in the display.

**8** Repeat steps #5 through #7 above to enter the rest of the rhythm and create the rhythm composition indicated in the notation on pages 26 – 27.

The following rhythms are used in this song:

Rhythm	Selection
60's 8Beat	[POPS] button menu, Page 1
8Beat Light 1	[POPS] button menu, Page 1
16Beat 1	[POPS] button menu, Page 3
Country Rock 2	[ROCK] button menu, Page 2
Hard Rock 2	[ROCK] button menu, Page 1
Folk Rock 1	[POPS] button menu, Page 1

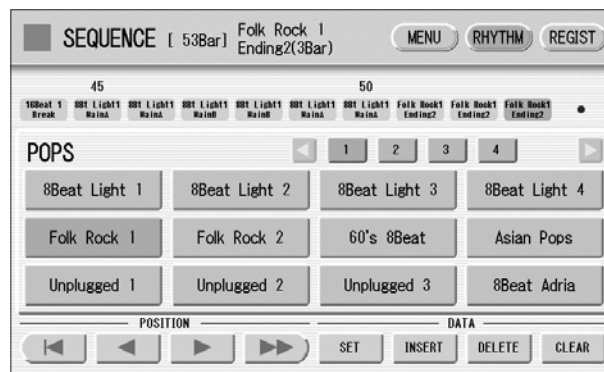

**NOTE** If you make a mistake in entering a rhythm, move the cursor to the rhythm you want to delete and press the [DELETE] button in the display, then reenter the correct rhythm.

ACT 1

ACT 2

ACT 3

ACT 4

# Creating a Registration Sequence Program

The Registration Sequence feature lets you program the Registrations you want to be automatically called up in sequence, when playing a Rhythm Sequence. This convenient feature frees you from having to work the footswitch, so you can concentrate completely on your keyboard performance.

## Programming the Registration Sequence

- 1 Press the [REGIST] button at the top right of the display to call up the REGIST Page.

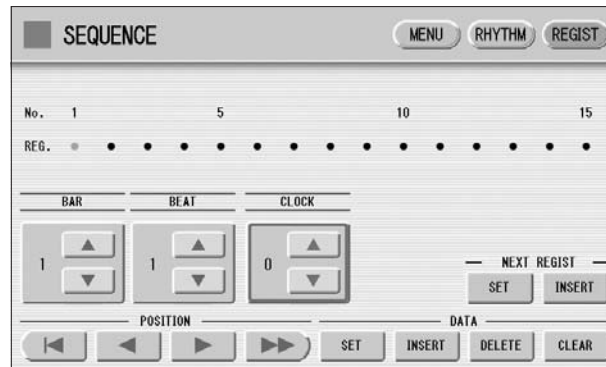

- 2 Press the Registration Memory [1] button to enter the setting to the Registration Sequence.
- 3 Set the timing location at which you want the Registration to change.  
Check the timing indication in the notation for the M1 event. You'll see it's written as "1.1.0" — meaning, Bar 1, Beat 1, Clock 0.
- 4 After setting the appropriate timing, press the DATA [SET] button in the display to actually enter M1 at that timing.

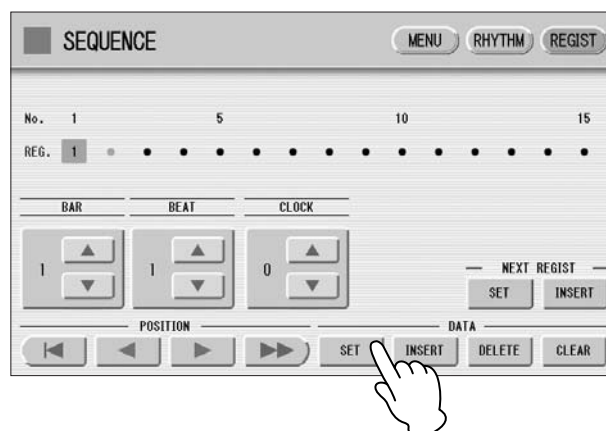

ACT 1

ACT 2

ACT 3

ACT 4

## 5 Repeat steps #2 through #4 above to finish creating the Registration Sequence indicated in the notation on pages 26 – 27.

The value continue changing if you hold the [▲] or [▼] button.

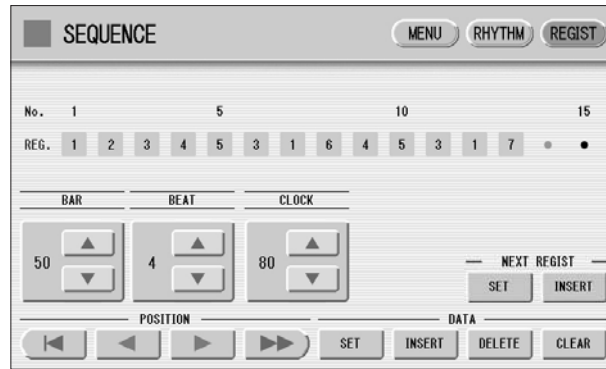

### Helpful Hint

Take a look at bar 14 in the notation. Registration M4 appears at the halfway point of the third beat in bar 14. Since one quarter-note beat equals 96 clocks and half of that is 48 clocks, you would think that the timing should be “14.3.48.” However, the indication is slightly before that, at “14.3.40.” Similarly, M5 is indicated as “22.4.90,” not “23.1.0.” The reason behind these anticipated settings is that the Registration may not have enough time to change all the sounds and settings in time for the performance, if the change is programmed exactly at the precise point of the intended change.



### NOTE

Up to 140 bars of events can be entered to one sequence button (for example, SEQ.1). The rhythm composition for “Change the World,” consisting of 52 bars, falls well within that one-button limit. However, you may want to start the song from the middle, or even mix up the arrangement differently than what is indicated here. To do that, you can divide the song into its component sections (verse, chorus, solos, etc.) and then assign each part to a separate SEQ. button. For example, you could assign a single sequence only for the guitar solo (bars 28 – 35). This would mean assigning the Registration sequence for bars 1 – 27 to the [SEQ.1] button, the sequence for bars 28 – 35 to the [SEQ.2] button, and that for bars 36 – 52 to the [SEQ.3] button. In this case, you’ll also need to divide the Registration Sequence into three sequence numbers. Also, keep in mind when programming that the first measure in each sequence is numbered “1,” no matter what number measure it actually is in the song.

## 6 Quit the Rhythm Sequence by pressing the [SEQUENCE] button in the DISPLAY SELECT section.

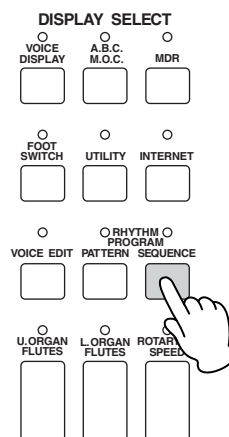

## Playing “Change the World”

Now that you’ve done all the necessary programming, you’re ready to play the song.

Press the [SEQ.1] button, then press the RHYTHM [START] button. The Rhythm Sequence composition starts from the first bar.

No need to use the footswitches. Just start playing and let the Electone do the hard work!



### NOTE

At the notes indicated with a “\*” mark, press the key and apply both Horizontal Touch (wiggling the key from side to side) and After Touch. This allows you to change the sound of the guitar much as an actual guitarist would, and makes both the sound and the overall performance sound much more realistic and expressive.

At the notes marked with “H.Vib,” apply Horizontal Touch to add the vibrato effect. (Horizontal Touch is available only on the ELS-01C.)

## Using the Music Data Recorder

In ACT 2, you used the M.D.R. to record your new Registration settings to a USB flash memory. Now, in this chapter, try recording your performance. After recording is finished, listen back to your newly recorded song.

### Recording the Performance

Here, we’ll show you how to set up and start recording.

- 1 **Insert a USB flash memory into the USB TO DEVICE terminal.**

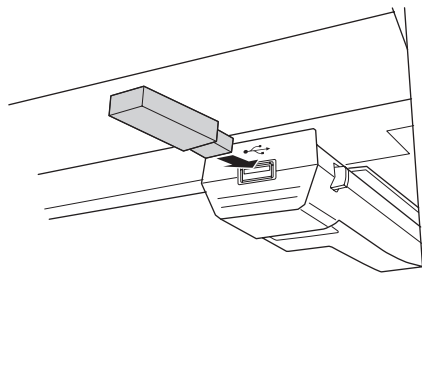

- 2 Press the [MDR] button to call up the M.D.R. display, then select the destination Song to which you want to record your performance (page 21).

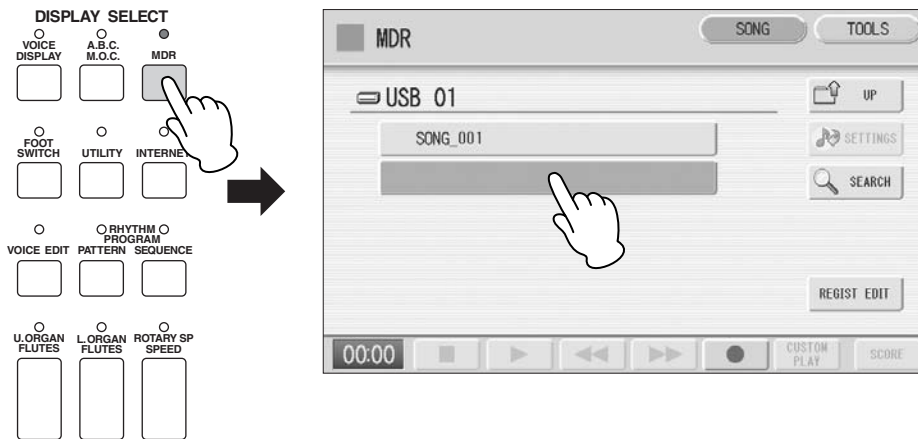

- 3 Press the [●] (Record) button in the display. The Rec Standby display appears.

- 4 Press the [▶] (Play) button in the display. The hourglass icon appears, indicating the Registration data is being read. After the hourglass disappears, start playing. First, press the [SEQ.1] button, then the RHYTHM [START] button, then begin playing the song.



**NOTE** If you make a mistake during recording, press the [●] (Record) button in the display. The recording stops and the M.D.R. returns to the starting point of the song. Then press the [▶] (Play) button or [CUSTOM] button to begin re-recording.



### Helpful Hint

If you press the [■] (Stop) button when you make a mistake, the recording stops and your aborted performance is automatically saved. If this happens and you don't need the recording, you can delete the song with the [SONG DELETE] button in the TOOLS Page of the M.D.R. display (see page 120 in the Owner's Manual).

## 5 When you finish playing, press the [ ■ ] (Stop) button.

The recording is finished and the display returns to the SONG Page. The song to which your performance is recorded is automatically named “SONG 2.” If you want to change the song name, see page 108 in the Owner’s Manual.



### NOTE

During recording, if you press any of the buttons on the panel, such as [ROTARY SP SPEED], the M.D.R. display is replaced by the button-selected display (for example, Rotary Speaker). If this happens, press the [MDR] button again to recall the M.D.R. display.

After recording is finished, you can play back the recorded performance by pressing the [ ► ] (Play) button in the M.D.R. display.



### NOTE

During playback of a song, you can fast forward, rewind, or pause the song as desired. You can also select the part to be played (see page 118 in the Owner’s Manual).

ACT 1

ACT 2

ACT 3

ACT 4

# ACT 4

## Creating Various Organ Sounds (ELS-01C)



Song:  
Moldau

- M 1** Classical Sound
- M 2** Soft Jazz Sound
- M 3** Tasty Jazz Sound
- M 4** Colorful Jazz Sound
- M 5** Percussive Rock Sound
- M 6** Classical Sound (same as M1)



In the last section of this tutorial, you'll explore the Organ Flutes feature of the ELS-01C and enjoy its wide variety of wonderful organ sounds.

Depending on the flute footage settings in the display, you can create a solemn pipe organ sound, tasty jazz organ sound, heavy rock organ sound, and much more.

The footage levers are similar to those on a conventional organ, letting you easily and realistically recreate traditional, famous organ songs.

Five Registrations are used in "Moldau." M1 is a solemn classical organ. M2 is a jazz organ for the section with the jazz waltz arrangement, while M3 and M4 are for the jazz swing part, and M5 is a powerful rock organ.



### Memo

#### About "Moldau"

The 19th century composer Bedrich Smetana is considered the founder of Czech national music. One of his greatest works, a set of symphonic poems called "My Fatherland," took him five years to complete. It is comprised of six parts, the most famous of which is "Moldau" — which is arranged here for the Electone.

The great river Moldau stretches for 430 kilometers, with its two sources starting in southern Bohemia, merging and running through the capital Prague — and represents the very heart and soul of the Czech people. Smetana's musical portrait of the Moldau provides a dynamic, highly melodic tour down the river, with a peasant wedding on one side and stately castles on the other. The beginning of this score brings to life the atmosphere of the original piece, expressing the majestic body of water, flowing and rushing through the countryside. Times have changed, however, and the old hunting trumpets and peasant dances have been replaced by jazz groups and rock bands — a complex image you can use as inspiration when you play this arrangement...

# Moldau

Composed by Bedrich Smetana  
Arranged by Riko Morino

ACT 1

ACT 2

ACT 3

ACT 4

♩=160~172  
M1

*mp* *mf*

M2

*r.f.* (right foot)  
*l.f.* (left foot)

Cm7 F7 B<sup>b</sup>M7 E<sup>b</sup>M7 Am<sup>-5</sup> D<sup>7(9)</sup> Gm7 C<sup>7(9)</sup>

ROTARY SP On (with right hand)

♩=160-172 (♩=♩<sup>3</sup>)

**C** A7 D7 Gm7 **M3** D<sup>b</sup> E<sup>b</sup> B<sup>b</sup> Cm7 F<sup>(9)</sup>  
KNEE (M.O.C.) On

B<sup>b</sup>M7 Cmadd9 Cm Gm Am<sup>5</sup> D7 Gm7  
KNEE (M.O.C.) On

**M4** C<sup>#</sup>dim D7 C<sup>#</sup>dim D C<sup>on</sup>E Fdim D7<sup>on</sup>F<sup>#</sup>

U.K. *f*

**M5** G **E**7<sup>(9)</sup>

ROTARY SP Off (with left footswitch)

L.K. *f* *gliss.*

**M6** **G**

*mf*

# Before Starting

In this chapter, we'll create the settings we want from the default settings of the instrument. Before starting, initialize the Registration Memory by following the steps on page 28. After initialization is complete, set the volume of each Voice section to 0.

## M 1 Classical Sound

The setting here is one of the most recognizable and representative settings of classical pipe organs, which have a wide and rich sonic range.

Imagine that you are in a large concert hall or a stone cathedral — one that has both a majestic pipe organ high above the floor and a small organ near the audience.

### Adjusting the Reverb Settings

- 1 Press the top of the REVERB button on the panel to set the depth to 24.

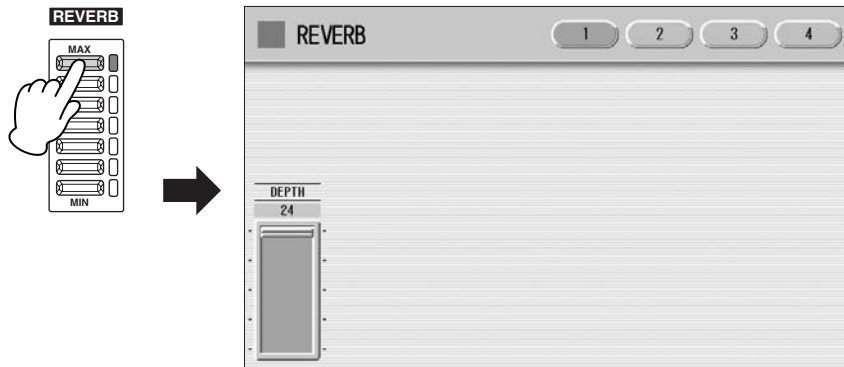

- 2 Press the [2] button at the top of the display, then check that the Type is set to [XG HALL 1].

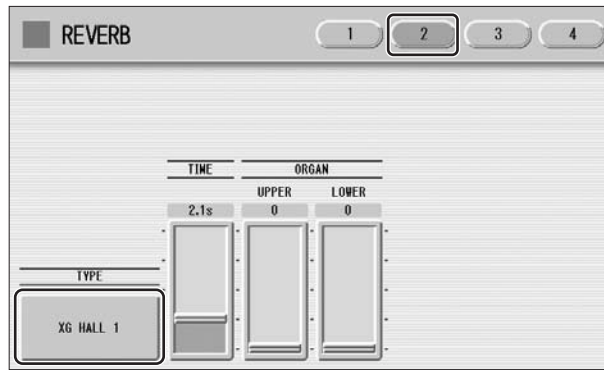

This reverb type recreates the lush ambience and reverberation of playing a majestic organ in a large hall.



**NOTE** The sliders in Page 2 of the Reverb display are the same as the Reverb slider in the Upper or Lower Organ Flute display. In these instructions, we'll adjust the reverb for the Organ Flute Voices by using the Reverb slider in the Organ Flute display, not the Reverb display.

## Creating the Upper Organ Flute Voice

- 1 Press the [U. ORGAN FLUTES] button.

The lamp of the [U. ORGAN FLUTES] button lights and the Upper Organ Flute display is called up.

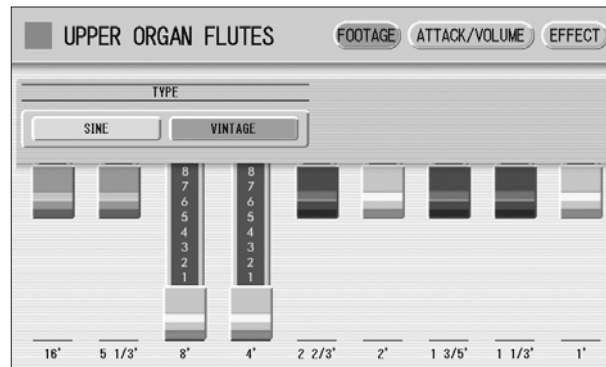
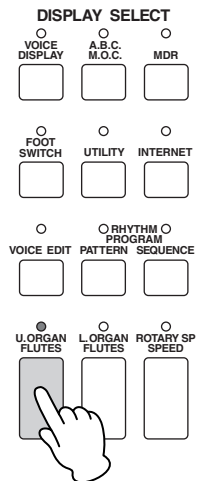

Change the sound type to [SINE], and change the flute footage settings as indicated below.

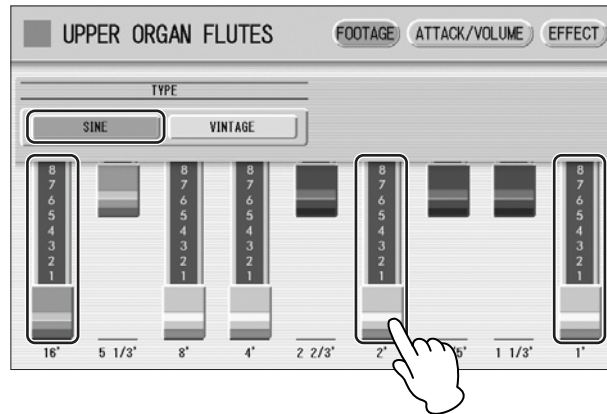

2 Press the [ATTACK/VOLUME] button at the top right of the display to call up the ATTACK/VOLUME Page, then change the display settings as indicated below.

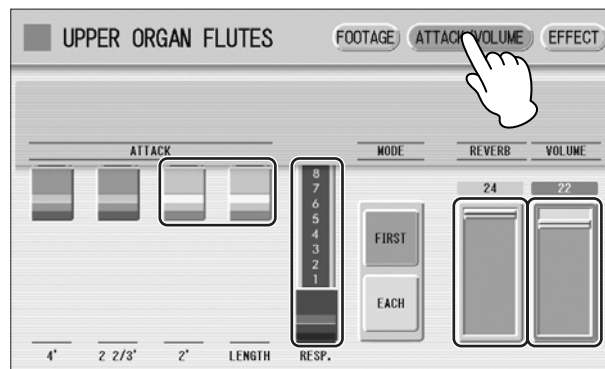

**NOTE** The response setting is one of the most important points in producing this classical sound. This delays the response of the notes when playing the keys, resembling the short, natural delay in an actual pipe organ.

3 Press the [EFFECT] button at the top right of the display to call up the EFFECT page, then set the Effect Type to [OFF].

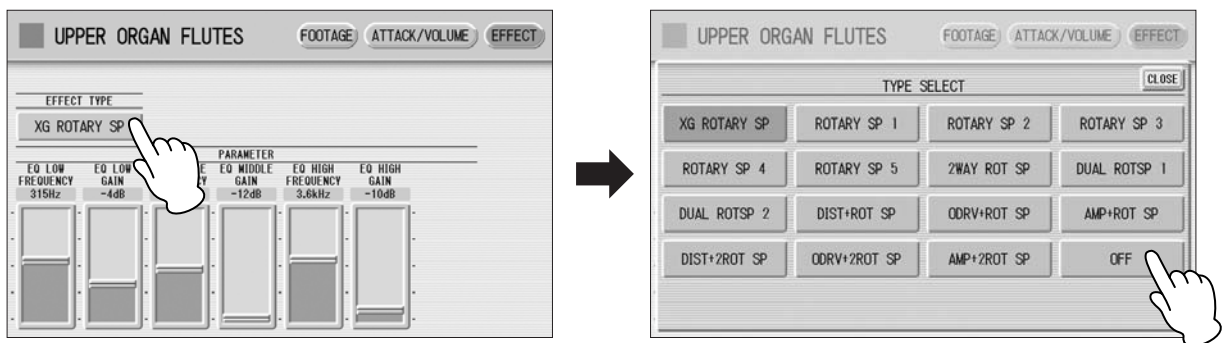

This completes the Upper Organ Flutes settings.

# Creating the Lower Organ Flute Voice

## 1 Press the [L. ORGAN FLUTES] button.

The lamp of the [L. ORGAN FLUTES] button lights and the Lower Organ Flute display is called up. Call up the FOOTAGE Page, then change the sound type to [SINE].

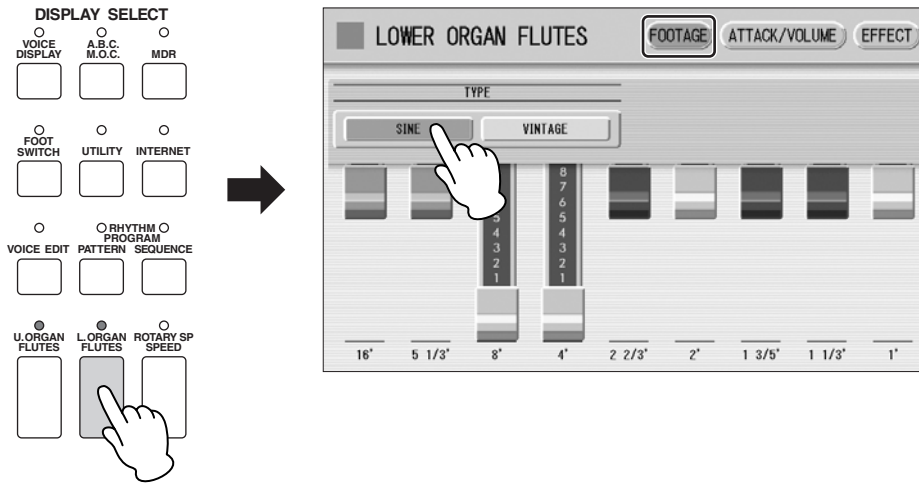

## 2 Press the [ATTACK/VOLUME] button at the top right of the display to call up the ATTACK/VOLUME Page, then change the display settings as indicated below.

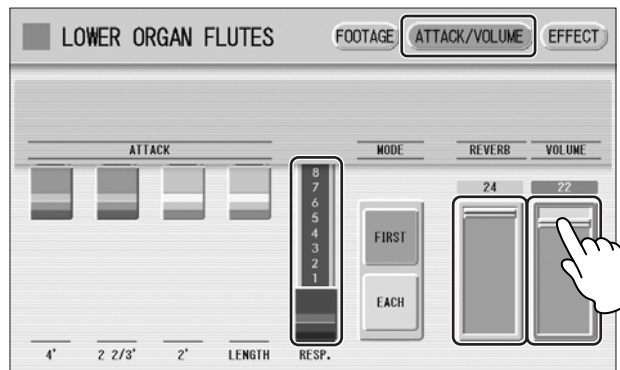

## 3 Press the [EFFECT] button at the top right of the display to call up the EFFECT page, then set the Effect Type to [OFF].

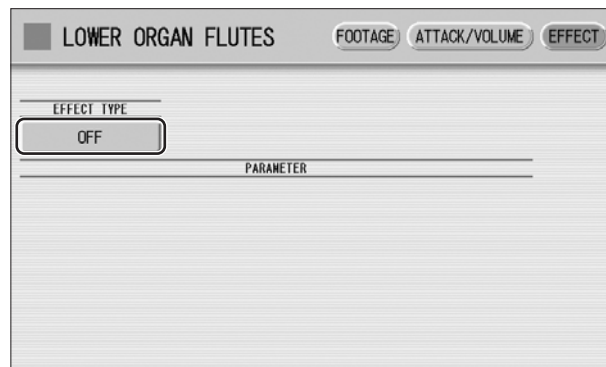

This completes the Lower Organ Flutes settings.

ACT 1

ACT 2

ACT 3

ACT 4

# Selecting and Editing the Pedal Voice



**NOTE** Since the Pedal Voice does not have the Organ Flute function, select the Pedal Voice by using the Voice buttons.

**1** Press the User button [1] of PEDAL VOICE 1.

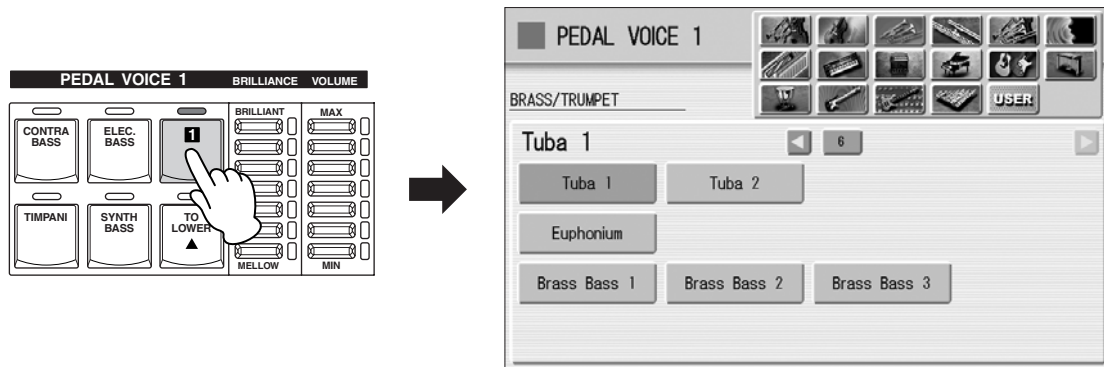

**2** Select the [Organ Bass 2] Voice from the Organ category, display Page 5.



## Helpful Hint

Choose your favorite Voice for the Pedal Voice, then change its Feet (octave) setting to best suit the Registration. Try that with Organ Bass or Pipe Organ, whichever you prefer.



### 3 Make the appropriate Voice Condition settings for Organ Bass 2.

Pressing the User button [1] on the panel again calls up the Voice Condition display. On Page 1 of the display, set Reverb to 24, Volume to 18, and Poly to ON. On Page 2 of the display, set Tune to -2.

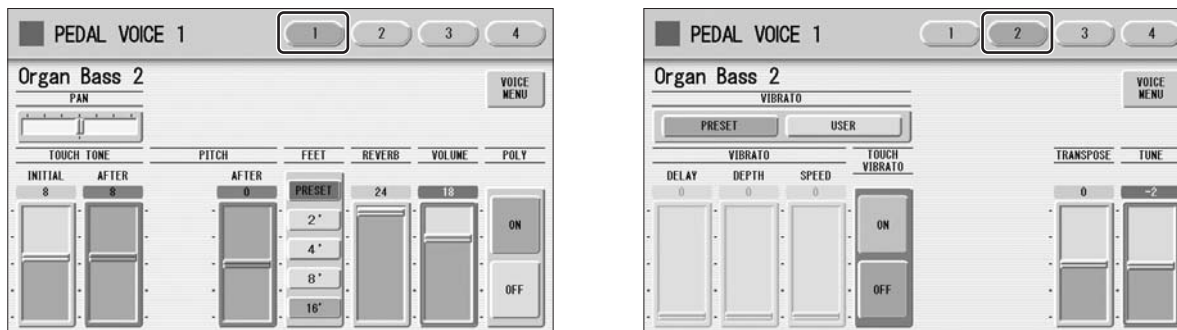

#### NOTE

The pedal polyphonic mode makes it possible to play legato on the pedalboard, letting you play notes on the pedalboard with both your left and right foot, at bar 9 in section **A**.

### 4 Confirm that the Effect is set to [PRESET] or [THRU] in display Pages 3 and 4.

This completes the PEDAL VOICE 1 settings.

For the M1 Registration, PEDAL VOICE 2 is not used. Turn its volume setting to 0.

Now that the Registration Memory 1 settings are complete, record them to the [1] button in Registration Memory section. Before recording, confirm that the lamps of the [U. ORGAN FLUTES] and [L. ORGAN FLUTES] buttons are lit.

**While holding down the [M.] (Memory) button in the Registration Memory section, press the [1] button.**

When the Registration is being stored, the [1] button flashes momentarily.

ACT 1

ACT 2

ACT 3

ACT 4

# M 2 Soft Jazz Sound

The setting here is a popular Jazz Organ sound. Since this sound has a strong 16' footage element, the setting is suited for a crisp and clear performance rather than chord performance. Now, we'll create the M2 Registration, based on M1.

## Creating the Upper Organ Flute Voice

- 1 Press the [U. ORGAN FLUTES] button twice to call up the Upper Organ Flutes display. In the FOOTAGE Page, change the flute footage settings as indicated below.

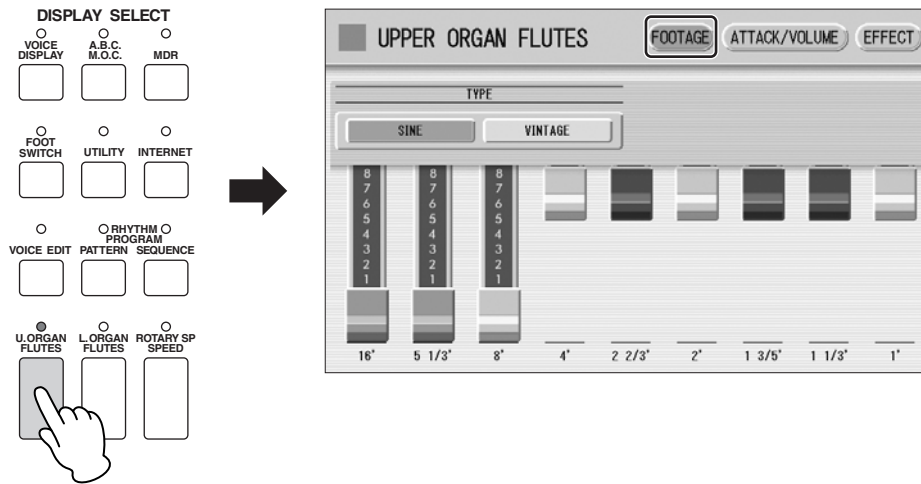

- 2 Press the [ATTACK/VOLUME] button at the top right of the display to call up the ATTACK/VOLUME Page, then change Attack 2 2/3' to 4, Response to 0, and Reverb to 8, as indicated here.

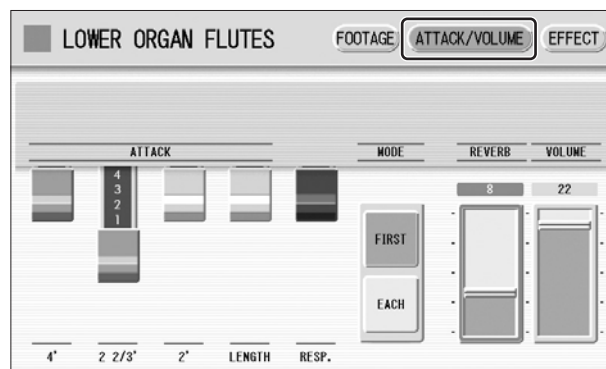

### NOTE

The Response lever was pulled down to the bottom to create a pipe organ-like sound in the M1 Registration. Here in the M2 Registration, however, the Response lever should be set to 0, to create a clear sound with quick attack. In addition, the lower setting of the reverb simulates a more intimate performance environment, with the organ placed near the audience.

- Press the [EFFECT] button at the top right of the display to call up the EFFECT page, then press the Effect Type button to call up the Effect Type list in the display. Select [2WAY ROT SP] from the list.

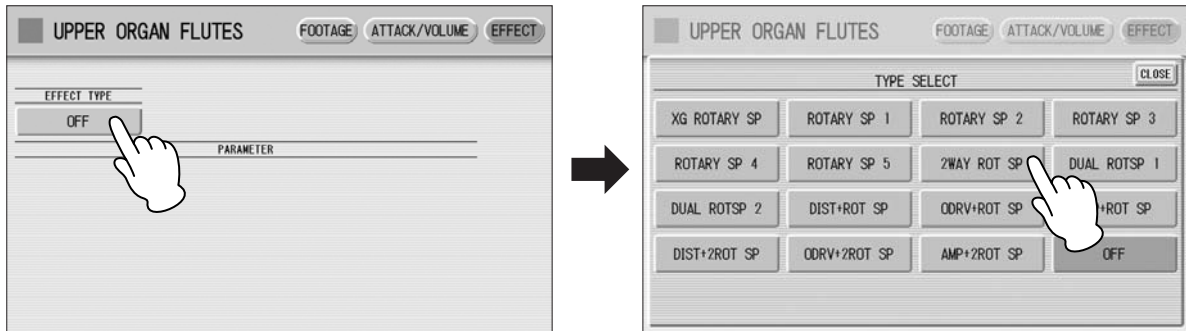

- Press the [ROTARY SP SPEED] button to call up the Rotary Speaker display.

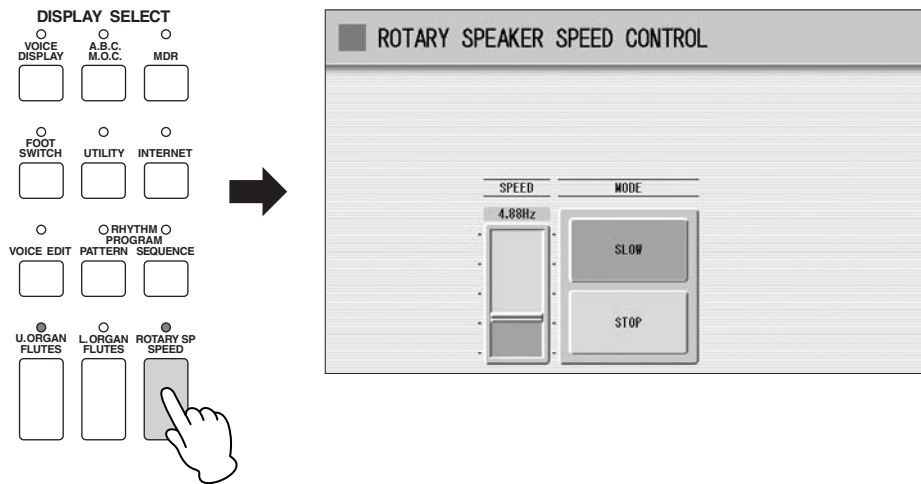

- Set the SPEED to 6.06 Hz.

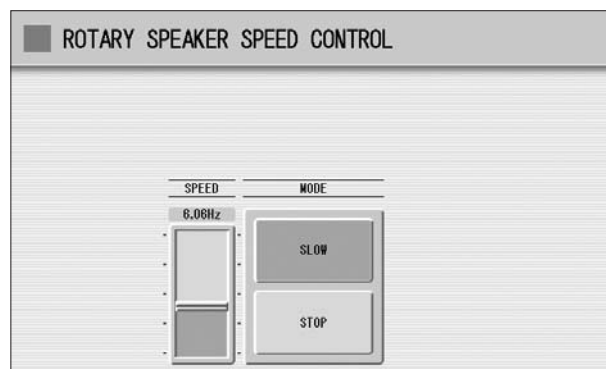

- Turn the Rotary Speaker off by pressing the [ROTARY SP SPEED] button again.

This completes the Upper Organ Flutes settings.

## Creating the Lower Organ Flute Voice

- 1 Press the [L. ORGAN FLUTES] button twice to call up the Lower Organ Flutes display. The settings on the FOOTAGE Page do not need to be changed.
- 2 On the ATTACK/VOLUME Page, change the Response to 0, Reverb to 8, and Volume to 15, as indicated below.

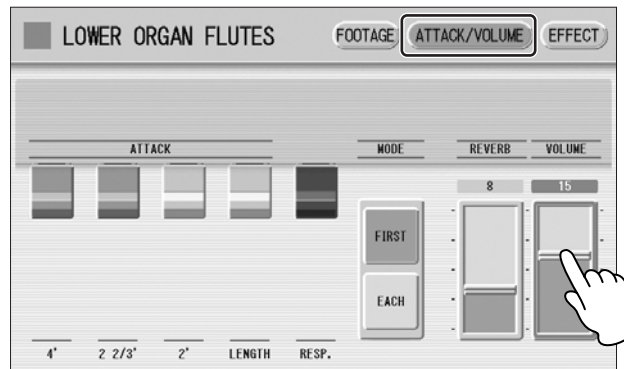

- 3 On the EFFECT page, press the Effect Type button to call up the Effect Type list in the display. Select [2WAY ROT SP] from the list.

This completes the Lower Organ Flutes settings.

## Selecting and Editing the Pedal Voice

- 1 Press User button [1] of PEDAL VOICE 1.

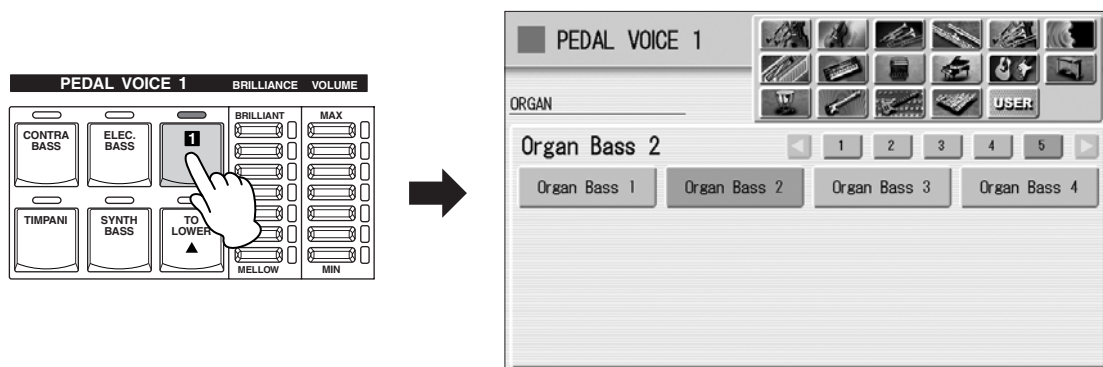

## 2 Select the [Organ Bass 1] Voice from the Organ category, display Page 5.



## 3 Make the appropriate Voice Condition settings for Organ Bass 1.

Pressing the User button [1] on the panel again calls up the Voice Condition display. On Page 1 of the display, set Reverb to 8, and Poly to OFF.

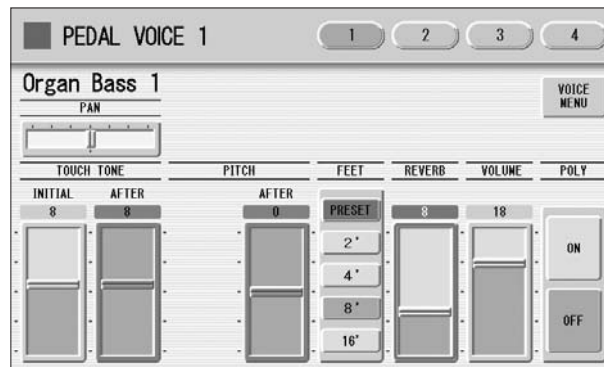

You don't need to make any changes in display Pages 2, 3 and 4.

This completes the PEDAL VOICE 1 settings.

For the M2 Registration, PEDAL VOICE 2 is not used. Check that its volume is set to 0.

Now that the Registration Memory 2 settings are complete, record them to the [2] button in Registration Memory section. Before recording, confirm that the lamps of the [U. ORGAN FLUTES] and [L. ORGAN FLUTES] buttons are lit, and the lamp of the [ROTARY SP SPEED] button is off.

**While holding down the [M.] (Memory) button in the Registration Memory section, press the [2] button.**

When the Registration is being stored, the [2] button flashes momentarily.

# M 3 Tasty Jazz Sound

The 1' footage setting is crucial in recreating this characteristic jazz organ sound. In the phrase using the M3 Registration, you'll have to trigger Melody On Chord operation with the knee lever. The point and duration in the song that this is to be performed is indicated by "KNEE (M.O.C.) ON" in the notation.

Now, we'll create the M3 Registration, based on M2.

## Creating the Upper Organ Flute Voice

- 1 Press the [U. ORGAN FLUTES] button twice to call up the Upper Organ Flutes display. In the FOOTAGE Page, change the flute footage settings as indicated below.

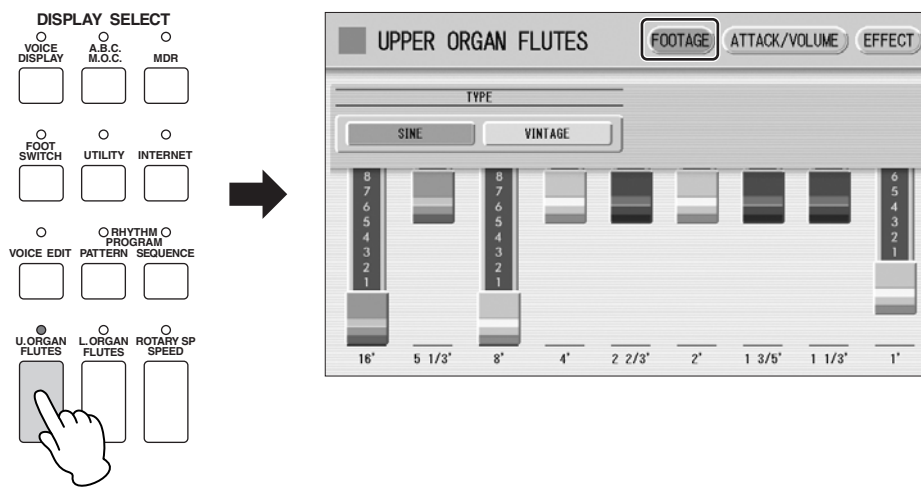

### Helpful Hint

You can set the amount of 1' footage as desired. When set low, the sound is warm and slightly subdued. You would think that adding more of this high tone would make the sound too brilliant. However, the footage gives the sound its "cool" jazzy character.

- 2 Press the [ATTACK/VOLUME] button at the top right of the display to call up the ATTACK/VOLUME Page, then set Attack 2 2/3' to 0.

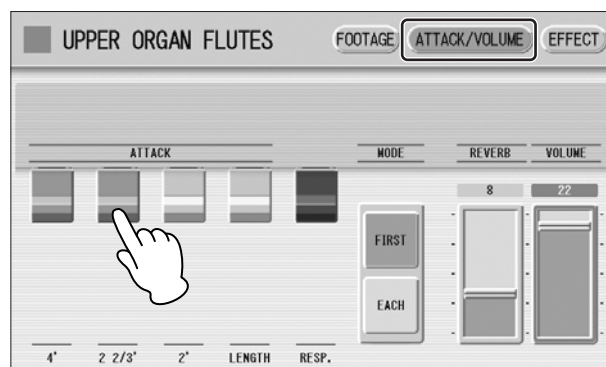

- Press the [A.B.C./M.O.C.] button on the panel to call up the A.B.C./M.O.C. display, then set the M.O.C. Mode to [1] and KNEE to [ON]. Also, fold down the Knee Lever to be able to use it during your performance.

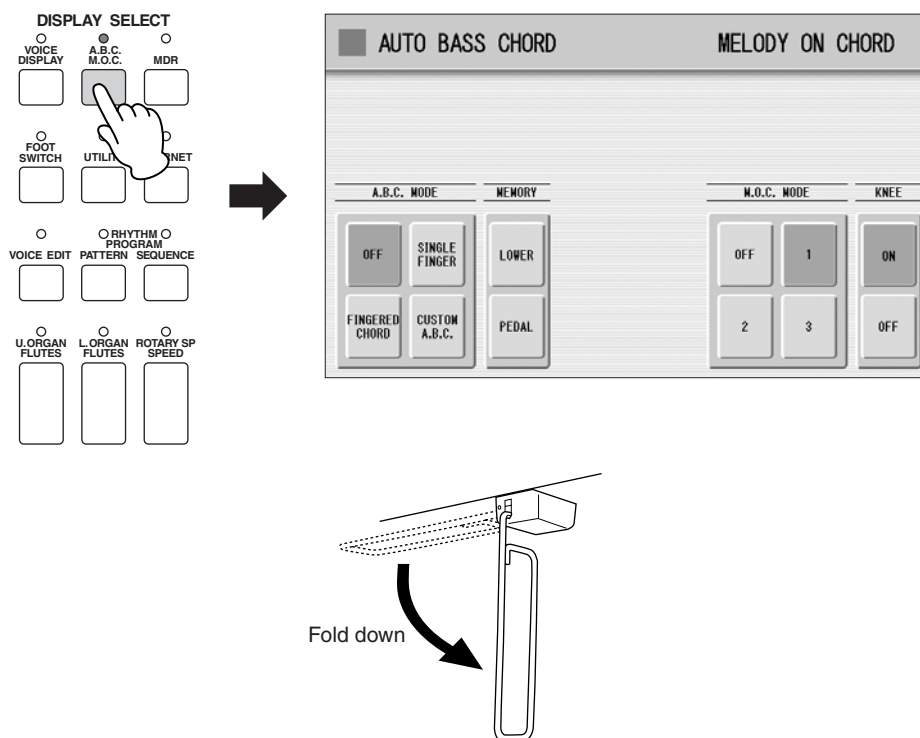

#### NOTE

In this song, you'll be switching Melody On Chord on or off with the Knee Lever. There are other ways of turning M.O.C. on/off — for example, by creating two Registrations. In one Registration, set the M.O.C. on, and in the other Registration, set it off. Using the Knee Lever has two advantages, however: It allows you to switch the M.O.C. on/off momentarily as you need (or don't need) it, and allows you to save Registration Memory settings for other changes.

This completes the Upper Organ Flutes settings.

You don't need to change the Lower Organ Flutes Voice and Pedal Voices.



#### Helpful Hint

Following section **[D]**, you might want to try playing the keyboards with a rhythm such as Combo Jazz or Cool Combo in the SWING & JAZZ category. Have fun finding a favorite rhythm to match with this song.

Now that the Registration Memory 3 settings are complete, record them to the [3] button in Registration Memory section. Before recording, confirm that the lamps of the [U. ORGAN FLUTES] and [L. ORGAN FLUTES] buttons are lit.

**While holding down the [M.] (Memory) button in the Registration Memory section, press the [3] button.**

When the Registration is being stored, the [3] button flashes momentarily.

ACT 1

ACT 2

ACT 3

ACT 4

# M 4 Colorful Jazz Sound

The footage lever settings are powerful and highly intuitive ways to shape richly textured organ sounds. Now, we'll create the M4 Registration, based on M3.

ACT 1

## Creating the Upper Organ Flute Voice

- 1 Press the [U. ORGAN FLUTES] button twice to call up the Upper Organ Flutes display. In the FOOTAGE Page, change the flute footage settings as indicated below.

ACT 2

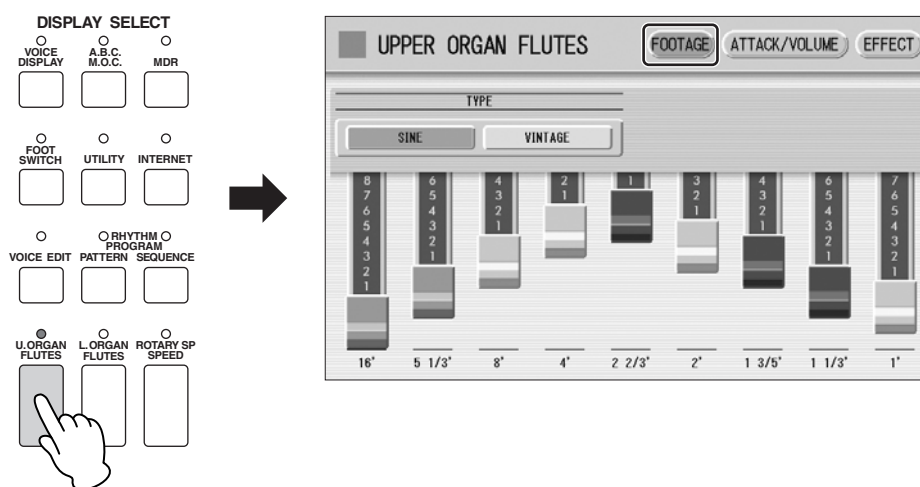

ACT 3

You don't need to make any changes in the ATTACK/VOLUME Page.

ACT 4

- 2 Press the [ROTARY SP SPEED] button to turn it on.

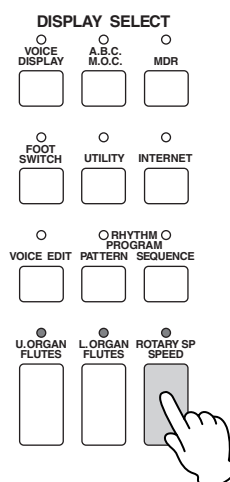



 **Helpful Hint**

The Melody On Chord you set for Registration M3 can be easily turned off by calling up the A.B.C./M.O.C. display and setting the Mode to OFF. Keep in mind, however, that even if you do not cancel M.O.C., the M.O.C. will have no effect unless you press the Knee Lever.

This completes the Upper Organ Flutes settings.

You don't need to change the Lower Organ Flutes Voice and Pedal Voices.

Now that the Registration Memory 4 settings are complete, record them to the [4] button in Registration Memory section. Before recording, confirm that the lamps of the [U. ORGAN FLUTES], [L. ORGAN FLUTES] and [ROTARY SP SPEED] buttons are all lit.

**While holding down the [M.] (Memory) button in the Registration Memory section, press the [4] button.**

When the Registration is being stored, the [4] button flashes momentarily.

ACT 1

ACT 2

ACT 3

ACT 4

# M 5 Percussive Rock Sound

With the addition of the 2 2/3' footage, the sound is more vivid and brilliant. The vintage wave setting also makes the sound more powerful. Finally, the setting of the Lower Organ Flute is ideal for playing bass phrases on the Lower keyboard.

Now, we'll create the M5 Registration, based on M4.

ACT 1

## Creating the Upper Organ Flute Voice

ACT 2

- 1 Press the [U. ORGAN FLUTES] button twice to call up the Upper Organ Flutes display. Change the sound type to VINTAGE, and change the flute footage settings as indicated below.

ACT 3

ACT 4

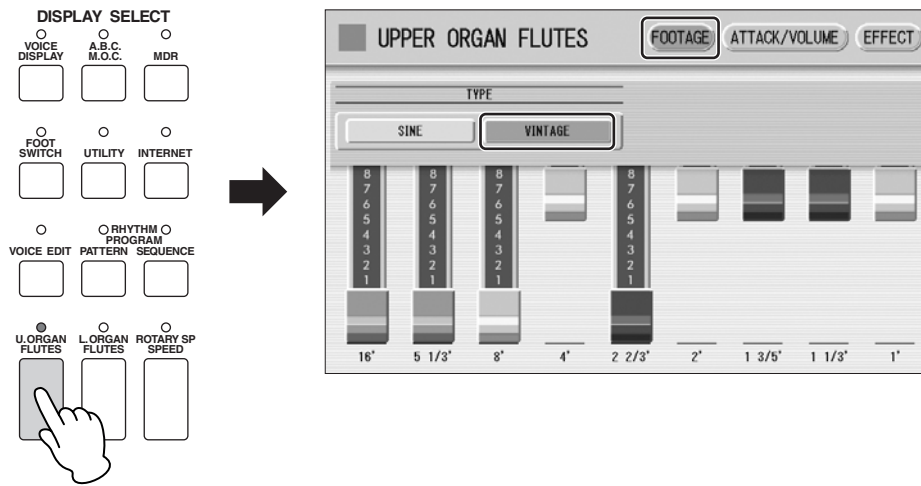

**NOTE** The M5 Registration is characterized by its vintage tone generation and distorted sound. Add the 1 3/5' footage if you like.

- 2 Press the [ATTACK/VOLUME] button at the top right of the display to call up the ATTACK/VOLUME Page, then set Attack 4' to 4.

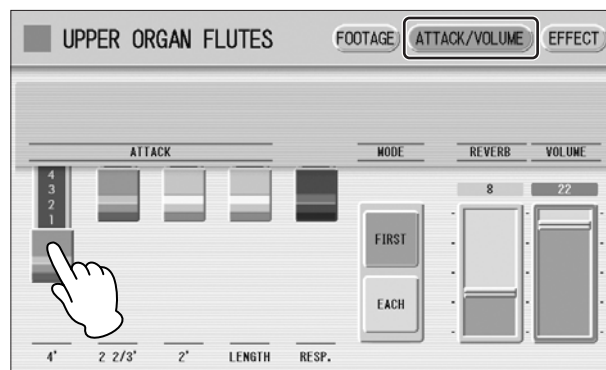

This completes the Upper Organ Flutes settings.

## Creating the Lower Organ Flute Voice

- 1 Press the [L. ORGAN FLUTES] button twice to call up the Lower Organ Flutes display. On the FOOTAGE Page, change the sound type to VINTAGE, and change the flute footage settings as indicated below.

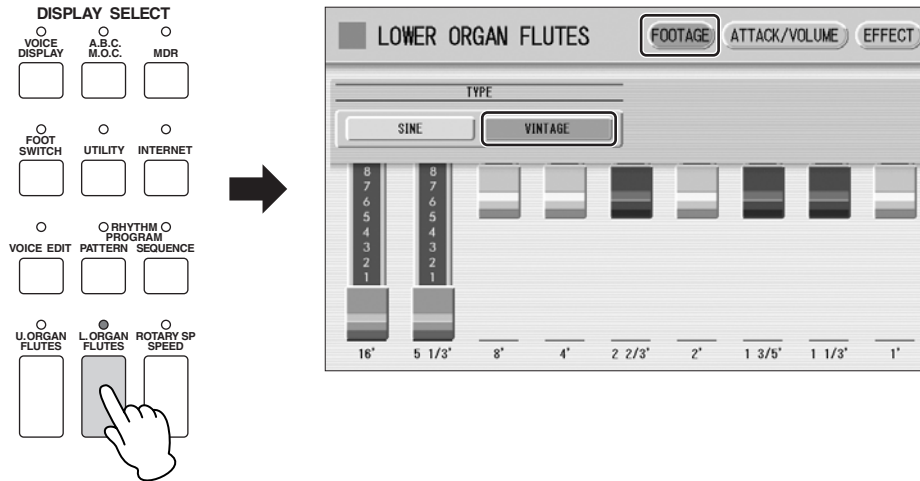

**NOTE** The setting of the Lower Organ Flute is ideal for playing bass parts on the Lower keyboard. Enjoy the deep, full sound.

- 2 Press the [ATTACK/VOLUME] button at the top right of the display to call up the ATTACK/VOLUME Page, then change the Volume to 20.

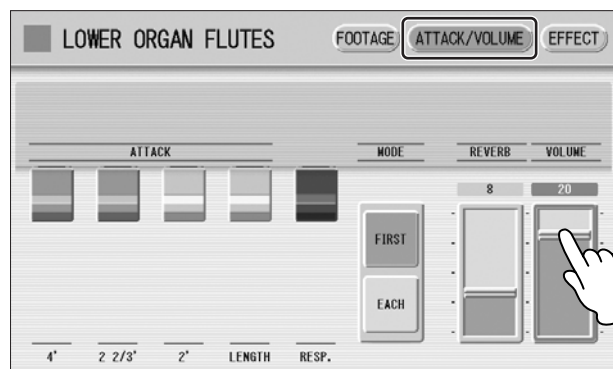

This completes the Lower Organ Flutes settings.

ACT 1

ACT 2

ACT 3

ACT 4

**3** Press the [FOOT SWITCH] button to call up the Footswitch display. On the LEFT Page, set the mode to [ROTARY SPEAKER].

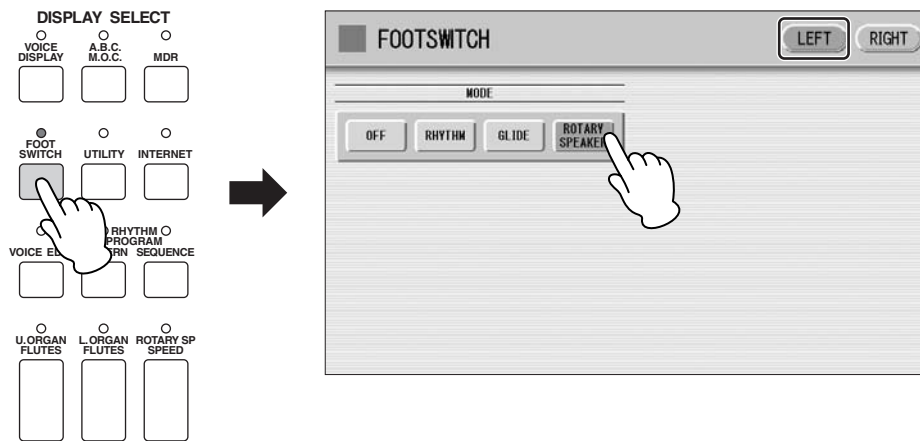

**NOTE** Other than by using the left footswitch, the Rotary Speaker can also be turned on/off by the [ROTARY SP SPEED] button on the panel, or by using two Registration Memories.

You don't need to change the Pedal Voices.

Now that the Registration Memory 5 settings are complete, record them to the [5] button in Registration Memory section. Before recording, confirm that the lamps of the [U. ORGAN FLUTES], [L. ORGAN FLUTES] and [ROTARY SP SPEED] buttons are all lit.

**While holding down the [M.] (Memory) button in the Registration Memory section, press the [5] button.**

When the Registration is being stored, the [5] button flashes momentarily.

## M 6 Classical Sound (same as M1)

The M6 Registration is completely the same as M1.

**Press the Registration memory [1] button to call up Registration M1. No changes are needed.**

Since the Registration Memory 6 settings are complete, record these settings to the [6] button in Registration Memory section.

**While holding down the [M.] (Memory) button in the Registration Memory section, press the [6] button.**

When the Registration is being stored, the [6] button flashes momentarily.

## Before Playing

During the performance, change the Registration memory by using the right footswitch. Before you start playing, make sure to set the Registration Shift function.

**Press the [FOOT SWITCH] button to call up the Footswitch display. In the RIGHT Page, set the Registration Shift mode to [SHIFT].**

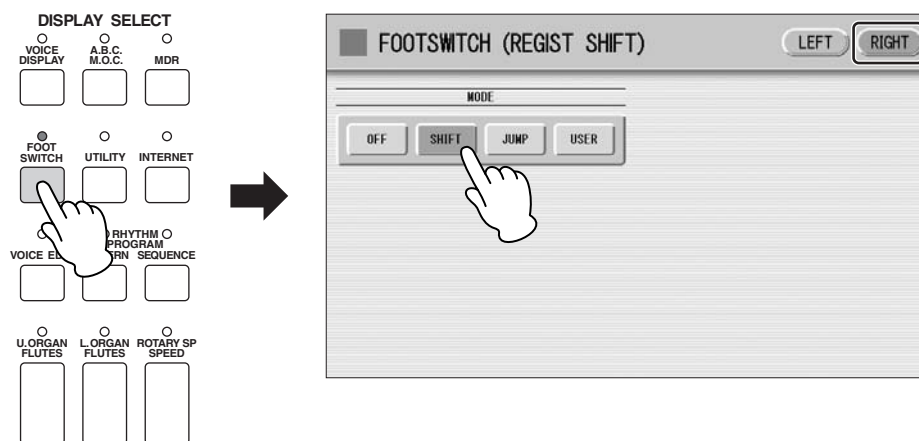

# Playing “Moldau”

**1** Press the [1] button in the Registration Memory section to call up Registration M1.

**2** Check that the Knee Lever is folded down.

The notation indicates the various points in the song where you’ll need to make changes to the instrument — shifting the Registration Memory, turning the Rotary Speaker on with your right hand, turning the Rotary Speaker off with the left footswitch, turning Melody On Chord on with the Knee Lever, and so on. Be careful to follow these indications as you play the Electone.

## Helpful Hint

The tempo written in the notation is only a rough indication of how the song should be performed. A lot of the performance depends on “feel.” When you start at section **[B]**, play in a relaxed way, and put in a little pause. In the jazzy arrangement (from **[B]** to **[E]**), ride the rhythm and play evenly. At the last bar of **[F]**, after turning off the Rotary Speaker, listen closely for the speed change of the Rotary Speaker effect. When you feel the rotation stop, shift the Registration to M6. At section **[G]**, decrease the tempo. Finish the song with a loud flourish or bring down the volume and end calmly, as you like. Either approach will work fine.

This arrangement showcases a variety of different organ sounds and features various dynamic stylistic changes. Play it with enthusiasm, and above all — enjoy it. You’re now an Electone master!

ACT 1

ACT 2

ACT 3

ACT 4





Yamaha Manual Library  
<http://www.yamaha.co.jp/manual/>

U.R.G., Digital Musical Instruments Division  
© 2004 – 2010 Yamaha Corporation  
WR03800 008MWCP\*\*-\*\*D0  
Printed in Japan