



DUAL MANUAL KEYBOARD **DDK-7**

Owner's Manual

PRECAUTIONS

PLEASE READ CAREFULLY BEFORE PROCEEDING

* Please keep this manual in a safe place for future reference.



WARNING

Always follow the basic precautions listed below to avoid the possibility of serious injury or even death from electrical shock, short-circuiting, damages, fire or other hazards. These precautions include, but are not limited to, the following:

Power supply/Power cord

- Only use the voltage specified as correct for the instrument. The required voltage is printed on the name plate of the instrument.
- Check the electric plug periodically and remove any dirt or dust which may have accumulated on it.
- Use only the supplied power cord/plug.
- Do not place the power cord near heat sources such as heaters or radiators, and do not excessively bend or otherwise damage the cord, place heavy objects on it, or place it in a position where anyone could walk on, trip over, or roll anything over it.

Do not open

- Do not open the instrument or attempt to disassemble the internal parts or modify them in any way. The instrument contains no user-serviceable parts. If it should appear to be malfunctioning, discontinue use immediately and have it inspected by qualified Yamaha service personnel.

Water warning

- Do not expose the instrument to rain, use it near water or in damp or wet conditions, or place containers on it containing liquids which might spill into any openings.
- Never insert or remove an electric plug with wet hands.

Fire warning

- Do not put burning items, such as candles, on the unit. A burning item may fall over and cause a fire.

If you notice any abnormality

- If the power cord or plug becomes frayed or damaged, or if there is a sudden loss of sound during use of the instrument, or if any unusual smells or smoke should appear to be caused by it, immediately turn off the power switch, disconnect the electric plug from the outlet, and have the instrument inspected by qualified Yamaha service personnel.



CAUTION

Always follow the basic precautions listed below to avoid the possibility of physical injury to you or others, or damage to the instrument or other property. These precautions include, but are not limited to, the following:

Power supply/Power cord

- When removing the electric plug from the instrument or an outlet, always hold the plug itself and not the cord. Pulling by the cord can damage it.
- Remove the electric plug from the outlet when the instrument is not to be used for extended periods of time, or during electrical storms.
- Do not connect the instrument to an electrical outlet using a multiple-connector. Doing so can result in lower sound quality, or possibly cause overheating in the outlet.

Location

- Do not expose the instrument to excessive dust or vibrations, or extreme cold or heat (such as in direct sunlight, near a heater, or in a car during the day) to prevent the possibility of panel disfiguration or damage to the internal components.
- Do not use the instrument in the vicinity of a TV, radio, stereo equipment, mobile phone, or other electric devices. Otherwise, the instrument, TV, or radio may generate noise.
- Do not place the instrument in an unstable position where it might accidentally fall over.
- Before moving the instrument, remove all connected cables.
- When setting up the product, make sure that the AC outlet you are using is easily accessible. If some trouble or malfunction occurs, immediately turn off the power switch and disconnect the plug from the outlet. Even when the power switch is turned off, electricity is still flowing to the product at the minimum level. When you are not using the product for a long time, make sure to unplug the power cord from the wall AC outlet.

- Do not place the instrument against a wall (allow at least 3 cm/one-inch from the wall), since this can cause inadequate air circulation, and possibly result in the instrument overheating.

Connections

- Before connecting the instrument to other electronic components, turn off the power for all components. Before turning the power on or off for all components, set all volume levels to minimum. Also, be sure to set the volumes of all components at their minimum levels and gradually raise the volume controls while playing the instrument to set the desired listening level.

Maintenance

- When cleaning the instrument, use a soft, dry cloth. Do not use paint thinners, solvents, cleaning fluids, or chemical-impregnated wiping cloths.

Handling caution

- Do not insert a finger or hand in any gaps on the instrument.
- Never insert or drop paper, metallic, or other objects into the gaps on the panel or keyboard. If this happens, turn off the power immediately and unplug the power cord from the AC outlet. Then have the instrument inspected by qualified Yamaha service personnel.
- Do not place vinyl, plastic or rubber objects on the instrument, since this might discolor the panel or keyboard.
- Do not rest your weight on, or place heavy objects on the instrument, and do not use excessive force on the buttons, switches or connectors.
- Do not use the instrument/device or headphones for a long period of time at a high or uncomfortable volume level, since this can cause permanent hearing loss. If you experience any hearing loss or ringing in the ears, consult a physician.

Saving data

Saving and backing up your data

- Always save data to a USB flash memory or other external media, in order to help prevent the loss of important data due to a malfunction or user operating error.

Backing up the external media

- To protect against data loss through media damage, we recommend that you save your important data onto two external media.

Yamaha cannot be held responsible for damage caused by improper use or modifications to the instrument, or data that is lost or destroyed.

Always turn the power off when the instrument is not in use.

The serial number of this product may be found on the bottom of the unit. You should note this serial number in the space provided below and retain this manual as a permanent record of your purchase to aid identification in the event of theft.

Model No. DDK-7

Serial No. _____

(bottom)

Congratulations!

You are the proud owner of a fine electronic keyboard, the DDK-7.

The Yamaha DDK-7 combines the most advanced tone generation technology with state-of-the-art digital electronics and features to give you stunning sound quality with maximum musical versatility.

In order to make the most of your DDK-7 and its extensive performance potential, we urge you to read the manual thoroughly while trying out the various features described.

Keep the manual in a safe place for later reference.

Accessories

- Owner's Manual
- Power cord

Main Features

Wide Variety of Registration Menus

page 20

The Registration Menu buttons feature a total of 288 Registrations, allowing you to instantly set up the DDK-7 for playing your favorite type of music. The Registrations in Registration Menu are divided into six basic categories for ease of selection. Moreover, you can edit any of the Registrations and customize them to fit your own performance needs.

Richly textured, four-layer AWM Voices and High Quality Digital Effects

pages 24 and 52

The DDK-7 contains a huge amount of exceptionally high-quality Voices – 415 altogether – created with the AWM (Advanced Wave Memory) tone generation system. The authentic touch response keyboard lets you play these Voices with all the expressiveness and control of an actual acoustic instrument. What's more, there are 183 different effect types in 15 categories that you can apply to each Voice section —letting you enhance and even completely change the character of the Voices, without having to use the Voice Edit features.

Dynamic, Contemporary Rhythms and Auto Accompaniment

page 60

The exceptionally wide selection of 274 rhythms lets you choose exactly the rhythm you need in your performance. Each rhythm contains 15 variations (sections) – such as Main, Fill In, Intro, Ending, and Break – that you can easily switch while you play, to make your performance even more dynamic and professional. Each rhythm has its own matching accompaniment divided into five instrument parts, providing basic backing as well as embellishments.

Comprehensive input and output connectors ideal for live performance

page 223

Since the DDK-7 is equipped with two types of AUX OUT jacks: MAIN and SUB, you can select outputs for each part. This lets you add an external effect to a specific part, or adjust the volume balance among the parts with an external mixer—allowing you to build up your own system and create just the sound you want.

Large, 6.5-inch TFT-LCD with Intuitive Touch Panel Operation

page 13

This large LCD display not only lets you clearly see a wide selection of settings and parameters at almost any angle, it also serves as a touch control panel — letting you intuitively make selections and adjust settings simply by touching the screen! Once you touch a setting, you can even adjust it in finer detail if necessary with the Data Control dial.

The DDK-7 is compatible with the following formats.



“GM (General MIDI)” is one of the most common Voice allocation formats. “GM System Level 2” is a standard specification that enhances the original “GM” and improves Song data compatibility. It provides for increased polyphony, greater Voice selection, expanded Voice parameters, and integrated effect processing.



XG is a major enhancement of the GM System Level 1 format, and was developed by Yamaha specifically to provide more Voices and variations, as well as greater expressive control over Voices and effects, and to ensure compatibility of data well into the future.



GS was developed by the Roland Corporation. In the same way as Yamaha XG, GS is a major enhancement of the GM specifically to provide more Voices and Drum kits and their variations, as well as greater expressive control over Voices and effects.



The Style File Format combines all of Yamaha’s auto accompaniment know-how into a single unified format.



This product utilizes NF, an embedded Internet browser from ACCESS Co., Ltd. NF is used with the patented LZW, licensed from Unisys Co., Ltd. NF may not be separated from this product, nor may it be sold, lent or transferred in any way. Also, NF may not be reverse-engineered, reverse-compiled, reverse-assembled or copied.

This software includes a module developed by the Independent JPEG Group.

- The bitmap fonts used in this instrument have been provided by and are the property of Ricoh Co., Ltd.
- This product incorporates and bundles computer programs and contents in which Yamaha owns copyrights or with respect to which it has license to use others’ copyrights. Such copyrighted materials include, without limitation, all computer software, styles files, MIDI files, WAVE data and sound recordings. Any unauthorized use of such programs and contents outside of personal use is not permitted under relevant laws. Any violation of copyright has legal consequences. **DON’T MAKE, DISTRIBUTE OR USE ILLEGAL COPIES.**
- Copying of the commercially available music sequence data and/or digital audio files is strictly prohibited except for your personal use.
- Electone and STAGEA are the trademarks of Yamaha Corporation.
- The company names and product names in this Owner’s Manual are the trademarks or registered trademarks of their respective companies.
- The illustrations and LCD screens as shown in this owner’s manual are for instructional purposes only, and may appear somewhat different from those on your instrument.
- The pan flute and sitar, shown in the displays of the DDK-7, are on display at the Hamamatsu Museum of Musical Instruments.
- This device is capable of using various types/formats of music data by optimizing them to the proper format music data for use with the device in advance. As a result, this device may not play them back precisely as their producers or composers originally intended.

Contents

Accessories	4
Main Features	5

Panel Layout 8

Front Panel	8
LCD Display/Display Select	10
Overview	10

1 Quick Introductory Guide 11

Getting Started	11
Using the LCD Display	13
LCD Display Settings	16
Voice Display	18
Registration Menu	20
Confirming the Version of Your DDK-7	23
Factory Set (Initializing the DDK-7)	23

2 Voices 24

Voices for each keyboard	24
Selecting Voices with the Voice buttons	26
Voice List	32

3 Organ Flutes 37

4 Voice Controls and Effects 40

Selecting from the Voice Condition display	41
Selecting from the panel	46
Effect List	52

5 Rhythm/Keyboard Percussion 60

Selecting rhythms with the Rhythm button	60
Rhythm List	68
Accompaniment	70
Automatic Accompaniment – Auto Bass Chord (A.B.C.)	71
Melody On Chord (M.O.C.)	73
Keyboard Percussion	74

6 Registration Memory 89

Storing Registrations	89
Selecting Registrations	91
Saving the Registration data to USB flash memory	92
Initializing Registration Memory	93
Registration Shift	94
Unifying a specific parameter	99

7 Music Data Recorder (MDR) 102

Calling Up the M.D.R. Display	103
Formatting External Media	103
Selecting a Song	104
Recording	110
Changing the Song Name	113
Saving Registrations as Registration Data (File)	116
Recalling Recorded Registrations	121
Playing Back a Song	122
Other Functions (Tools)	128

8 Voice Edit 137

Voice Structure	137
Editing a Voice	138
Saving the edited Voice	145
Quitting Voice Edit	146
Recalling an Edited Voice	146

9 Rhythm Program 147

Outline of the Rhythm Programming Operation	147
Rhythm Pattern Program	148
Rhythm Sequence Program	183
Saving Rhythm Pattern and Rhythm Sequence Data to external media	192

10 Controllers 193

Footswitches	193
Foot Pedal	196
Expression Pedals	205

11 Transpose and Pitch Controls 208

12 Internet Direct Connection 209

Connecting the Instrument to the Internet	209
Accessing the Website from the DDK-7	210
About the Internet Settings Display	218
Exiting from the Internet Display	221
Initializing Internet Settings	221
Glossary of Internet Terms	222

13 Connections 223

Accessory Jacks and Controls	223
Connecting Headphones or External System	225
Connecting a Pedal Unit	229
Connecting a Foot Pedal	229
Connection with Computer	230
Connecting External Devices	231
MIDI	235
MIDI Control	238

14 Appendix 240

XG Voice & Drum List	240
XG Drum Map	245
MIDI Data Format	248
Troubleshooting	263
Specifications	266
Index	268

1 Quick Introductory Guide

2 Voices

3 Organ Flutes

4 Voice Controls and Effects

5 Rhythm/Keyboard Percussion

6 Registration Memory

7 Music Data Recorder (MDR)

8 Voice Edit

9 Rhythm Program

10 Controllers

11 Transpose and Pitch Controls

12 Internet Direct Connection

13 Connections

14 Appendix

Panel Layout

Front Panel

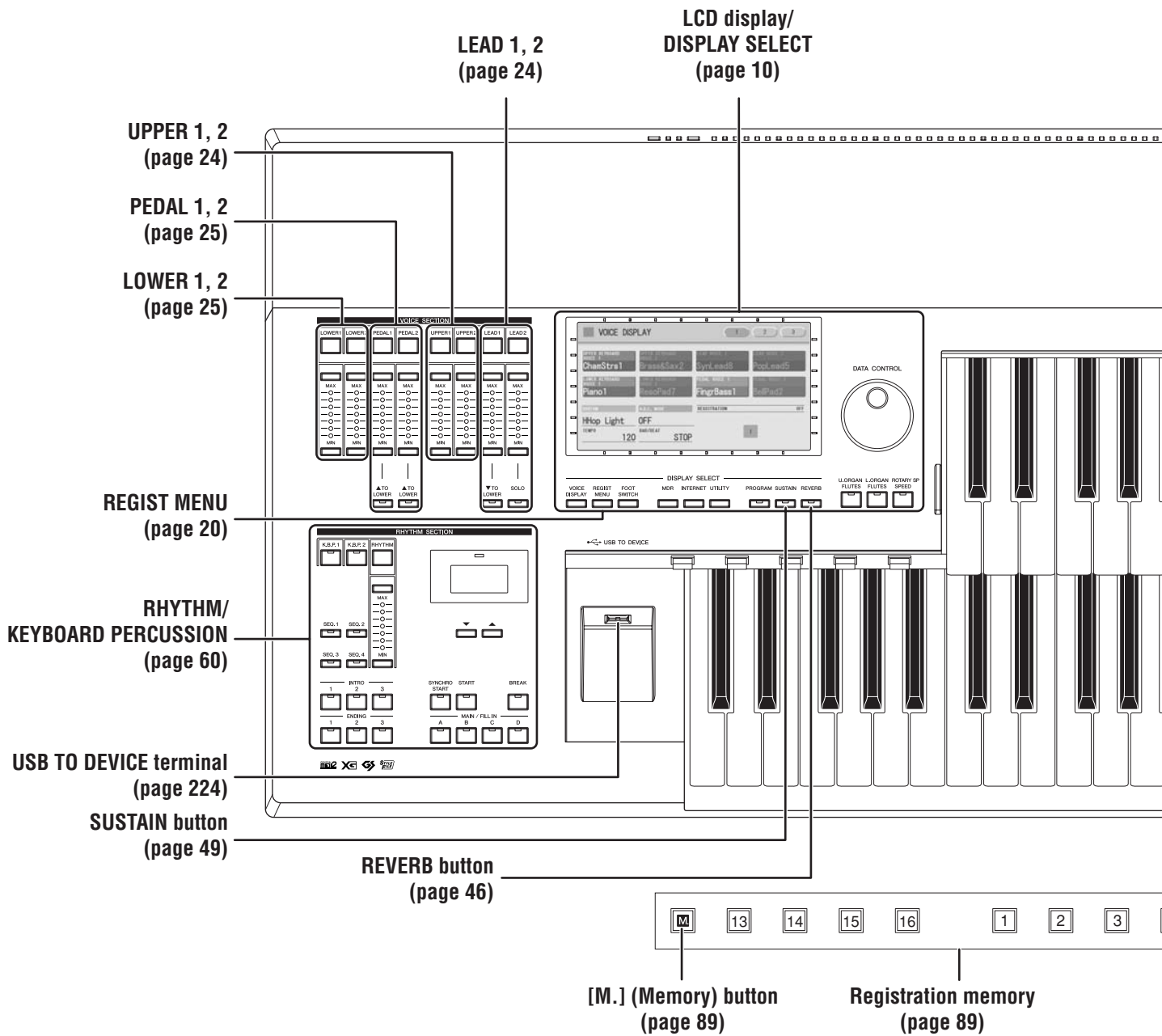

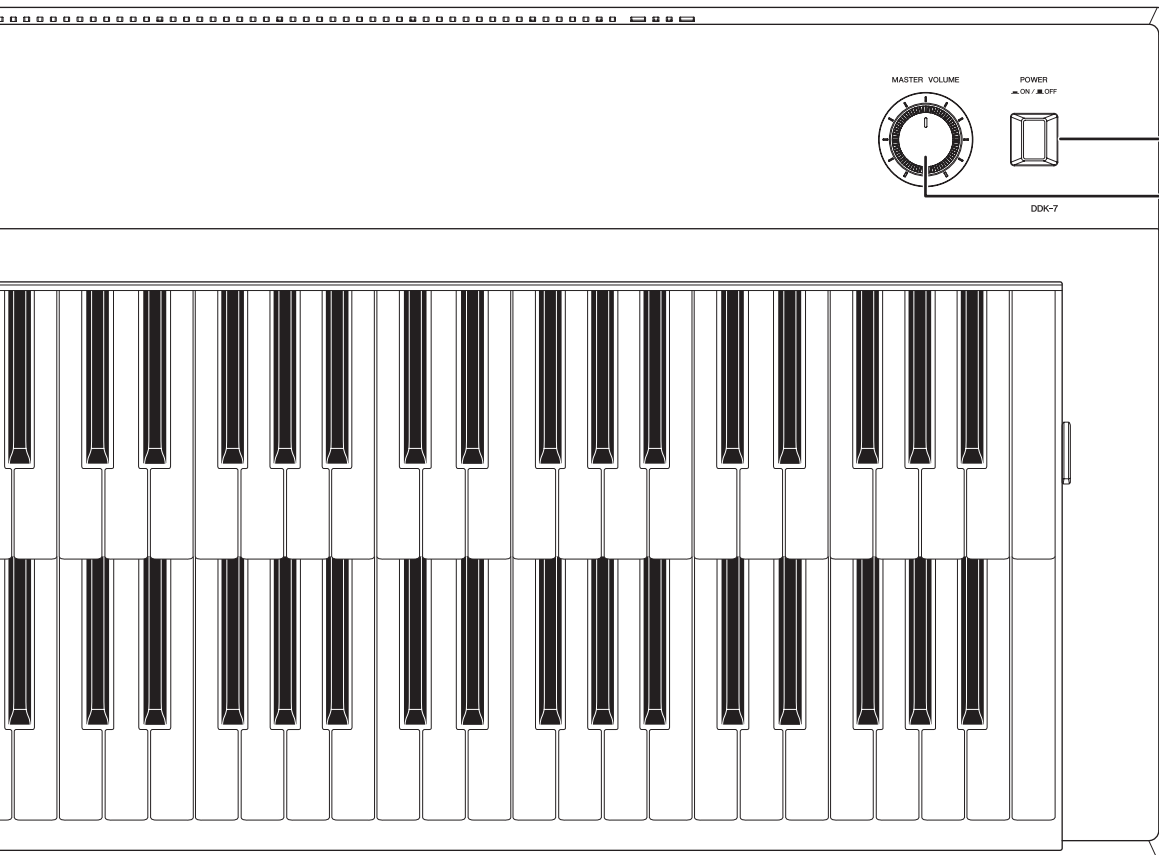

POWER switch
(page 12)

MASTER VOLUME
dial (page 12)



[D.] (Disable) button
(page 91)

LCD Display/Display Select

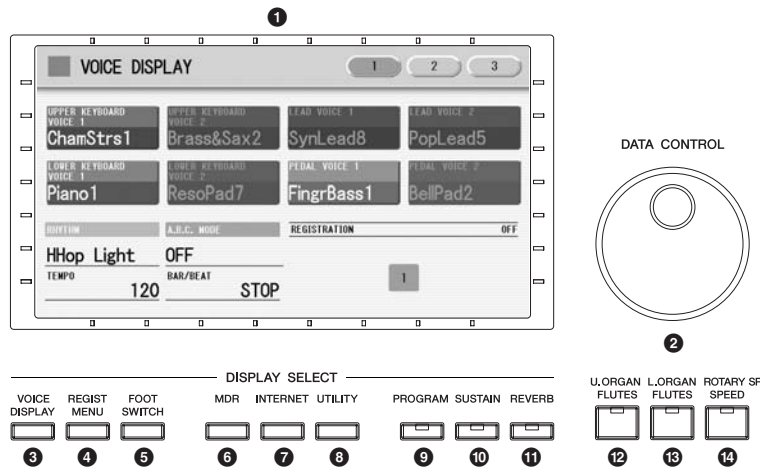

- ① LCD display (touch-panel) page 13
- ② DATA CONTROL dial page 15
- ③ [VOICE DISPLAY] button page 18
- ④ [REGIST MENU] button page 20
- ⑤ [FOOT SWITCH] button pages 94, 193
- ⑥ [MDR] button. page 102
- ⑦ [INTERNET] button page 210
- ⑧ [UTILITY] button pages 16, 205, 208, 238

- ⑨ [PROGRAM] button page 138
- ⑩ [SUSTAIN] button page 49
- ⑪ [REVERB] button page 46
- ⑫ [U. ORGAN FLUTES] button. page 37
- ⑬ [L. ORGAN FLUTES] button page 37
- ⑭ [ROTARY SP SPEED] button page 50

Overview

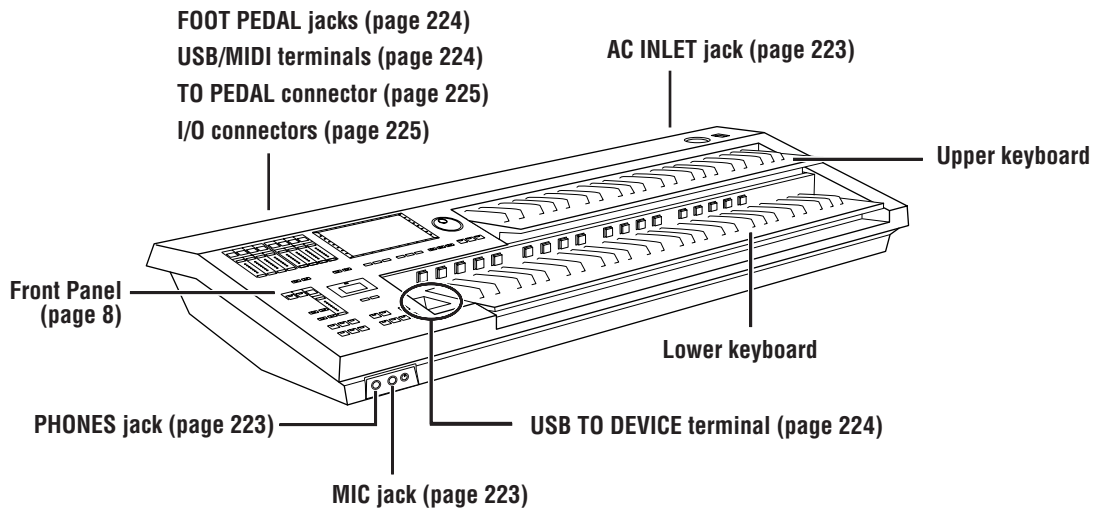

Whether you are an advanced performer or have never touched an electronic keyboard in your life, we recommend that you take the time to go through this basic section. It shows you in the simplest possible manner how to start playing your DDK-7.

Contents

1 Getting Started	11	4 Voice Display	18
2 Using the LCD Display	13	5 Registration Menu	20
• Changing the Display Page	13	• Selecting Registrations	20
• Pressing Buttons on the Display	14	• Registration Menu List	22
• Adjusting Parameter Values by Using the Display Sliders	15	6 Confirming the Version of Your DDK-7	23
3 LCD Display Settings	16	7 Factory Set (Initializing the DDK-7)	23
• Selecting the Display Language	16		
• Muting the Touch Panel Sound	17		
• Adjusting the Display Brightness	17		

1 Getting Started

1 Connect the power cord.

First insert the plug of the power cable into the AC INLET on the DDK-7, then plug the other end of the cable into the proper AC outlet on the wall.

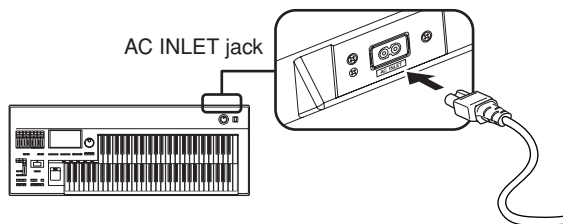

Only use the voltage specified as correct for the DDK-7. The required voltage is printed on the name plate of the DDK-7. Yamaha products are manufactured specifically for the supply voltage in the area where they are to be sold. If you intend to use the instrument in another location, or if any doubt exists about the supply voltage, please consult with a qualified technician.

2 Connect the speakers or headphones.

Since the DDK-7 has no built-in speakers, you will need to monitor the sound of the instrument by using external equipment. Connect a set of headphones, powered speakers, or other playback equipment as required.



Reference Page

Using Headphones (page 225)
 Playing the Sounds of the DDK-7 Through an External Audio System (page 226)
 Using a mixer for live performance (page 226)



Do not use the instrument/device or headphones for a long period of time at a high or uncomfortable volume level, since this can cause permanent hearing loss.

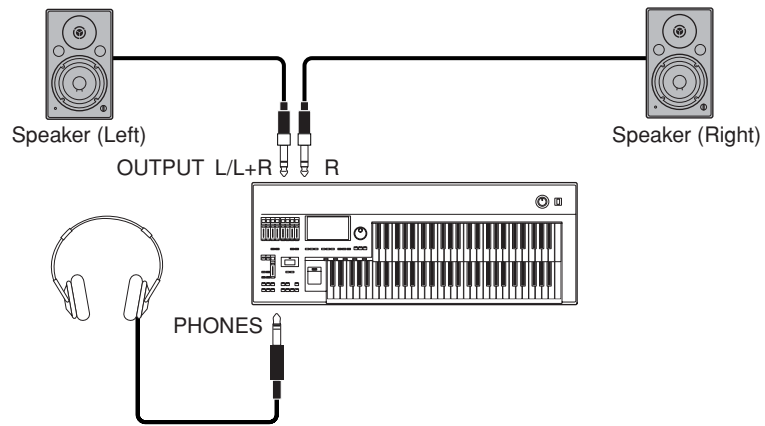

Even when the power switch is turned off, electricity is still flowing to the product at the minimum level.

3 Turn the power on.

Make sure the volume settings of the DDK-7 and external devices are turned down to the minimum.

MASTER VOLUME

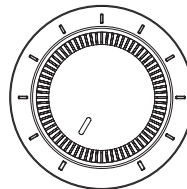

Turn the power on by pressing the [POWER] switch on the DDK-7 front panel, then turn the power on the amplifiers.

POWER
▲ ON / ▼ OFF

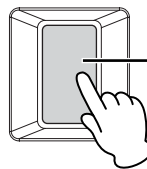

For turning the power on or off.

When powering down the setup, make sure to switch off the power of the external device (or lower its volume) before switching off the DDK-7.



NOTE

when you connect an external audio device to the AUX OUT jacks, the output level is fixed and cannot be controlled.

4 Set the MASTER VOLUME control.

The MASTER VOLUME control is an overall control that affects the volume of the entire instrument.

MASTER VOLUME

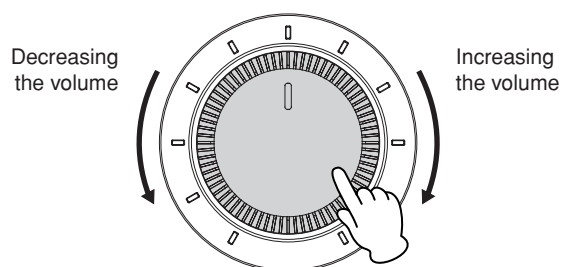

Now that you've set up the DDK-7 properly, you're ready to begin playing it. The Expression Pedal on the DDKU-P7 Pedal Unit can be used to control the volume with your foot as you play.

2 Using the LCD Display

This instrument features a special touch panel that allows you to change the parameters by simply touching the ‘virtual’ buttons or sliders on the display. (Please note that two or more parameters cannot be operated simultaneously.)

You can also use the Data Control dial to make fine changes to the parameter value shown in the display.



NOTE

When cleaning the display, use a soft, dry cloth.



Do not use any sharp or hard tools to operate the touch panel. Doing so may damage the display.

Changing the Display Page

There are some oval-shaped numbered buttons at the top right of the display. Pressing these buttons changes the “page” of the display. The selected page’s button turns orange.

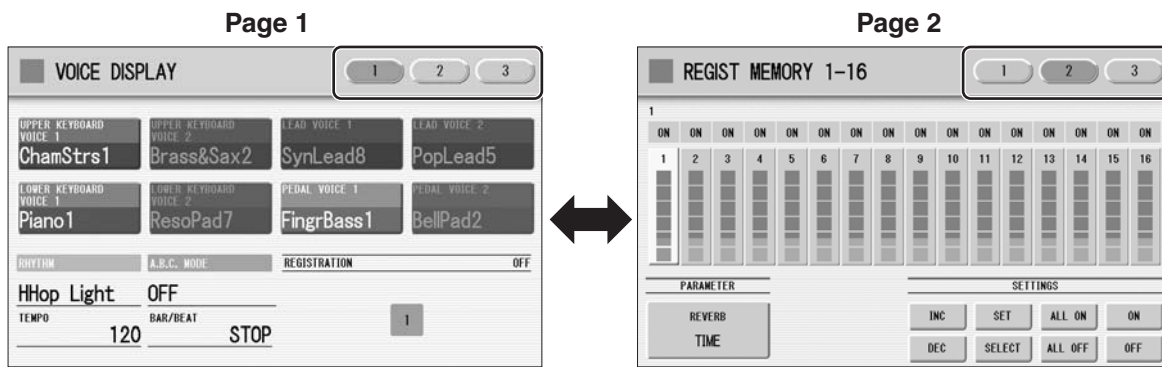

Press this button to select Page 1

Press this button to select Page 2



Pressing Buttons on the Display

There are three types of buttons: those that select a function, those that switch a function on/off, and those that open a list or menu of parameters. To select the desired function, simply press the button in the display directly.

For switching on/off or opening a parameter list, see the instructions below.

To switch the function on or off:

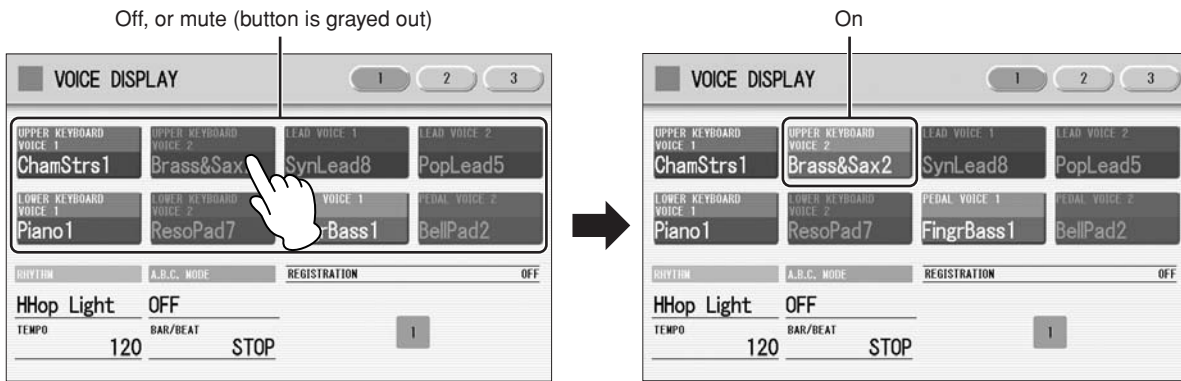

You can independently mute each Voice section in the Voice Display, each accompaniment part in Rhythm Menu display, and each Element in the Voice Edit display.

To open the parameter list:

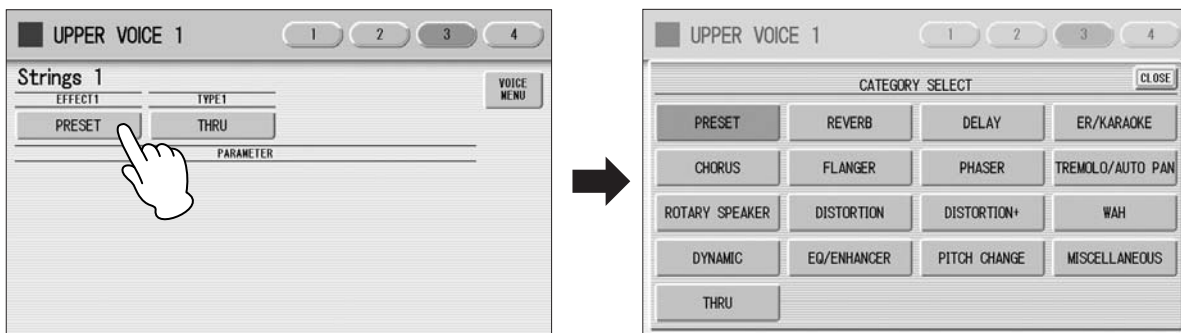

When you press the button, a parameter list will appear in which you can select the desired parameter.

Adjusting Parameter Values by Using the Display Sliders

You can adjust some parameters such as Volume, Reverb, Pan and so on, by using the 'virtual' sliders in the display. There are two ways to move the slider in the display: touching it directly, and using the Data Control dial. We suggest that you touch the display slider when making coarse adjustments and use the Data Control dial for fine adjustment.

Touching the display slider directly:

Press a point in the slider to which you want to adjust the parameter value. The slider will move to the point you pressed. Also, by sliding your finger up or down while holding down the display slider, you can change the parameter value.

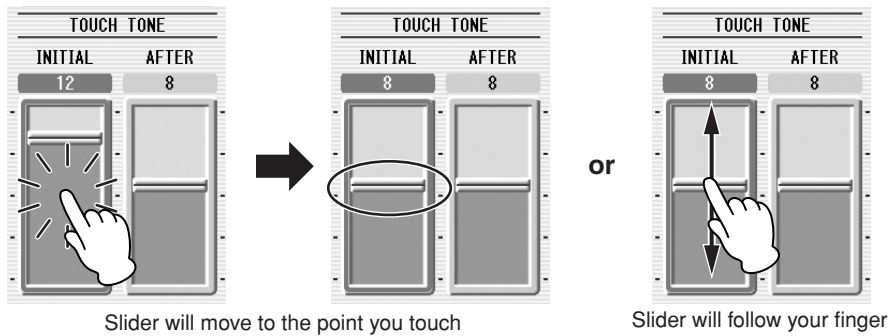

Using the Data Control dial:

Touch on/above the slider in the display to enable the parameter and set a rough value, then turn the Data Control dial.

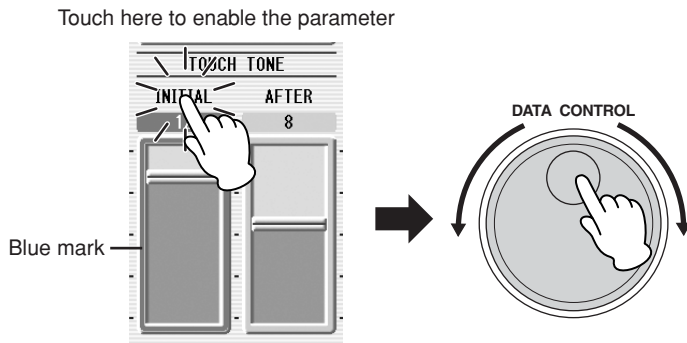

To control Pan, you can move the horizontal slider in the same way as vertical sliders.

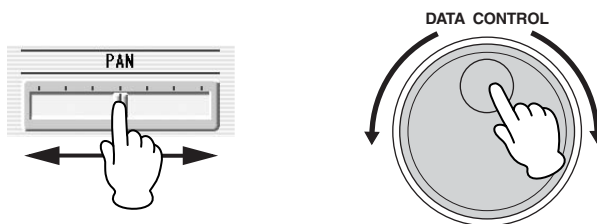

3 LCD Display Settings

Here you can change the display settings: displayed language (English or Japanese), touch panel sound, and display brightness.

Selecting the Display Language

The LCD display can be shown in two languages, English and Japanese. The default setting is English.



NOTE

The settings in the Utility Display are automatically saved when another display is called up.

1 Press the [UTILITY] button to call up the GLOBAL Page of the Utility Display.

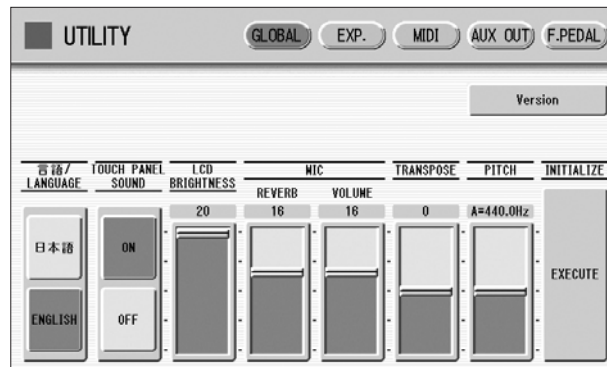
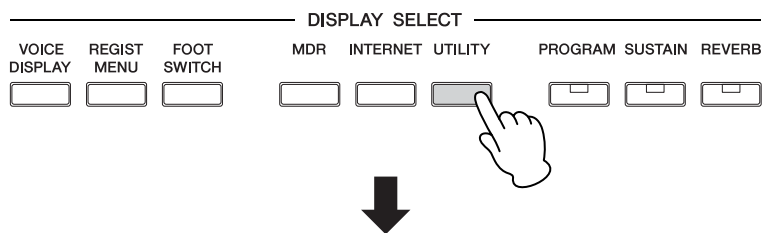

2 Press the desired button, 日本語 (Japanese) or [English].

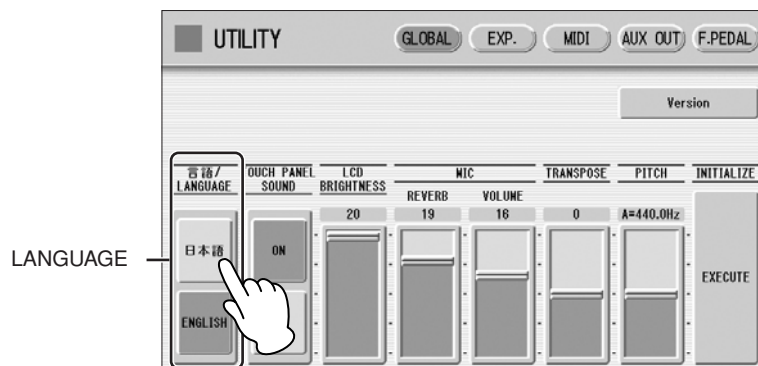

Muting the Touch Panel Sound

The DDK-7 is set by default with the touch panel sound turned on, giving you audio feedback when you press a button or control. If you want to mute the touch panel sound, follow the procedure below.

- 1 Press [UTILITY] button to call up GLOBAL Page of the Utility Display.
- 2 Press the [OFF] button of the TOUCH PANEL SOUND to mute the sound.

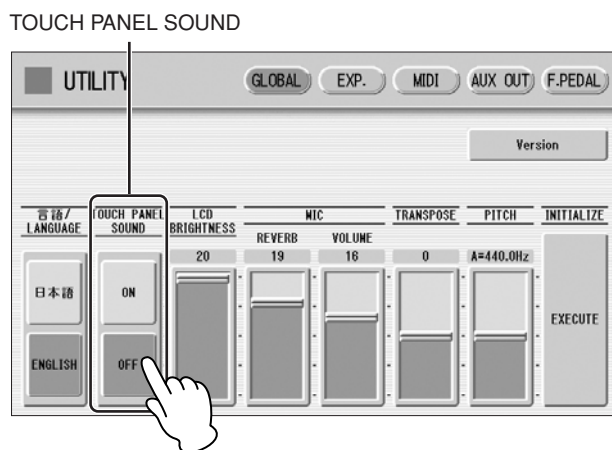

To turn the sound on again, select [ON] in Step #2.

Adjusting the Display Brightness

You can adjust the display brightness to a comfortable, easy-to-read level.

- 1 Press the [UTILITY] button to call up the GLOBAL Page of the Utility Display.
- 2 Move the LCD BRIGHTNESS slider by touching it directly or using the Data Control dial.

Higher settings make the display brighter and lower settings make it darker.

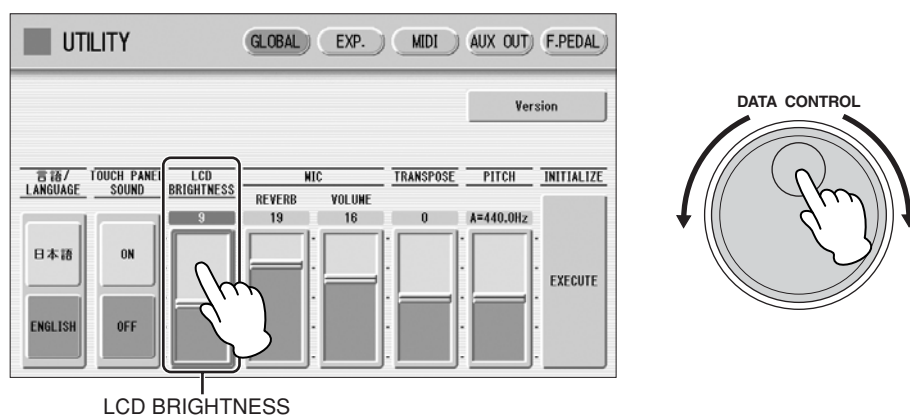

4 Voice Display

You can visually confirm the currently assigned Voices to each keyboard, currently selected rhythm, Registration Shift, and so on, in the Voice Display.

How to call up the Voice Display:

The Voice Display always appears when the DDK-7 is turned on. To call up the Voice Display from any other display, press the [VOICE DISPLAY] button.

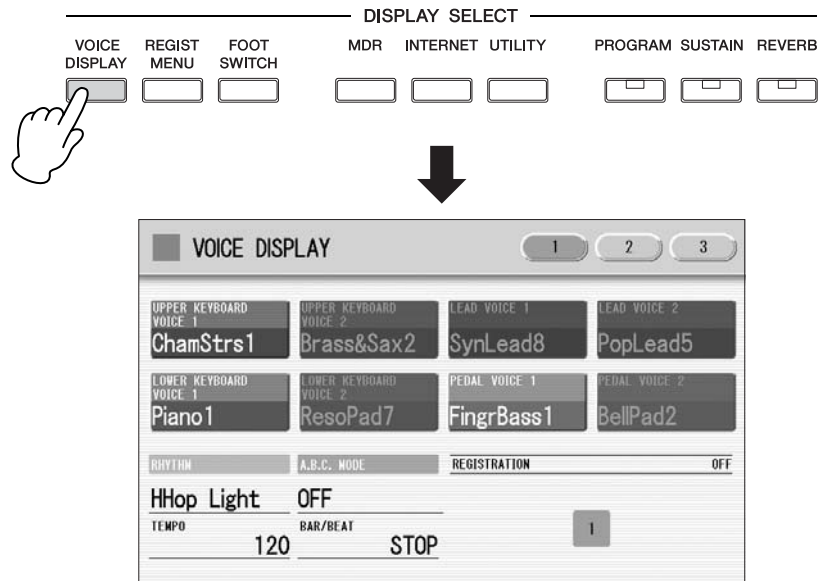

The Voice Display consists of three different pages that can be switched by pressing the [1], [2] or [3] button at the top right of the display.

Voice Display [Page 1]

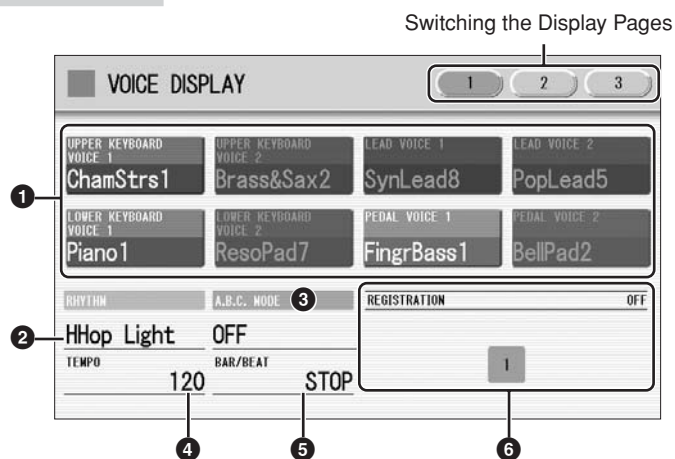

1 Voice Sections

Shows the Voices currently assigned to each Voice section. You can also mute specific Voice section by pressing its button (the button is grayed-out).



Reference Page

Selecting a Voice (page 26)

2 RHYTHM

Shows the currently selected rhythm.



Reference Page

Selecting a rhythm (page 60)

3 A.B.C. MODE

Shows the mode of the Auto Bass Chord.



Reference Page

Auto Bass Chord (page 71)

4 TEMPO

Shows the current rhythm tempo.



Reference Page

Adjusting the tempo (page 66)

5 BAR/BEAT

Shows the bar/beat when the rhythm is playing.

6 REGISTRATION

Shows the current position of the Registration Shift.



Reference Page

Registration Shift (page 94)

Voice Display [Page 2]

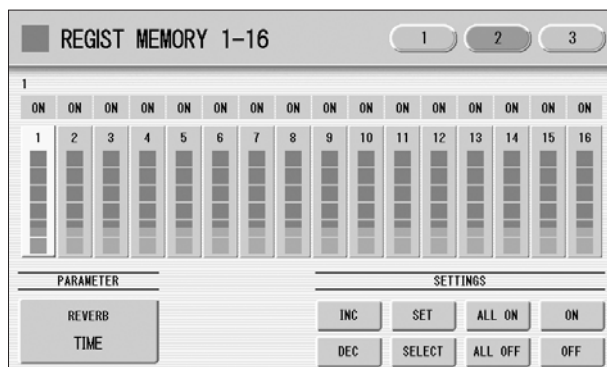

You can confirm the parameter values (for example, Reverb, Volume, Pan) for each Registration Memory simultaneously. Moreover, you can unify a specific parameter used in various Registration Memories at one time. See page 99 for the details.

Voice Display [Page 3]

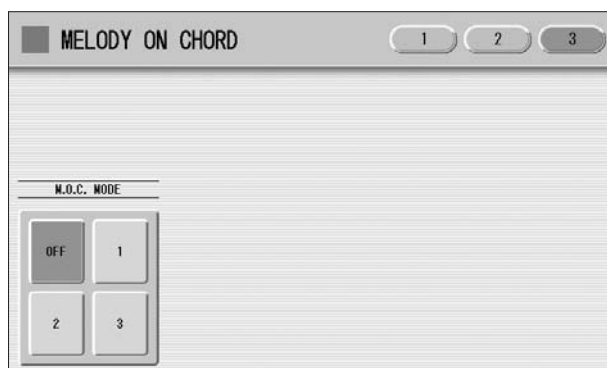

Determines the Melody On Chord modes. See page 73 for details.

**NOTE**

Additional basic Registrations are preset on the Registration Memory locations from 1 to 16. See page 89 for details.

5 Registration Menu

A “Registration” consists of panel settings including the selected Upper Keyboard Voices, Lower Keyboard Voices, Pedal Voices, rhythm and so on. The Registration Menu button includes 288 Registrations, specially suited for playing in a different music style.

Selecting Registrations

- 1 Press the [REGIST MENU] button to call up the Registration Menu display.

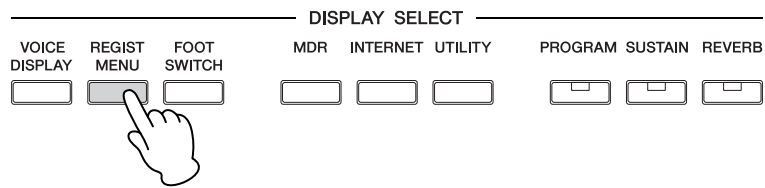

- 2 Select the desired registration category with the category buttons in the display.

Each button has different Registrations for different music genres. For example, if you want to play Jazz, press the [JAZZ & LATIN] button. For details on the Registration Menu, see page 22.

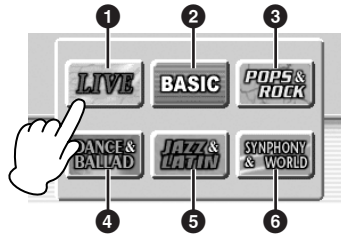

1	Live Performance
2	Basic
3	Pops & Rock
4	Dance & Ballad
5	Jazz & Latin
6	Symphony & World

3 Select the desired Registration by pressing the appropriate button on the display.

One display page contains 12 Registration buttons. Pressing the numbered buttons in the display changes the display pages, letting you select up to 48 Registrations from one Registration category button.

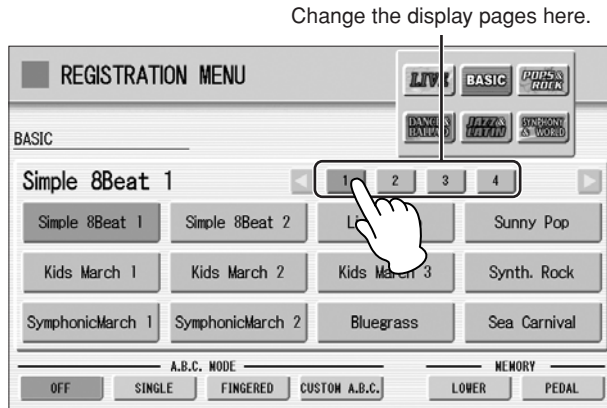

The color of the selected Registration name changes to orange, indicating that it has been selected, and the Auto Bass Chord mode is shown at the bottom of the display.



Reference Page

Auto Bass Chord (page 71)

4 Play your favorite song with the selected Registration.

Registration Menu List

Page	LIVE PERFORMANCE	BASIC	POPS & ROCK	DANCE & BALLAD	JAZZ & LATIN	SYMPHONY & WORLD
1	Bell Pop Piano	Simple 8 Beat 1	Dynamic 8 Beat	Organ Ballad	Blow On Sax	Fanfare
	AOR Piano	Simple 8 Beat 2	NY Ballad	Dramatic Ballad	Sax Ensemble	String Orchestra
	Ballad Stack	Light Step	British Pop	Love Ballad	Moonlight	Romantic Violin
	Rockin'on Piano	Sunny Pop	8 Beat Modern	Smooth Lead	Big Band	Baroque
	Ballad Piano	Kids March 1	Rock Band	Pop Ballad	Clarinet Swing	Flute&Harp
	LA Fusion	Kids March 2	Detroit Pop	Guitar Ballad	Jazz Combo	Serenade
	70's Pops	Kids March 3	Techno Pop	Acoustic Ballad	Medium Jazz	Fast March
	Pop E.Piano	Synth. Rock	Sheriff Reggae	Healing Guitar	Organ Session	Wild West
	Prism E.Piano	Symphonic March 1	Rock&Roll	Chillout	Guitar Combo	Vienna Waltz
	Kool E.Piano	Symphonic March 2	Power Rock	Sweetheart 1	Tender Ballad	Polka
Spacey E.Piano	Bluegrass	60's Guitar Rock	Sweetheart 2	Jazz Waltz	Chanson Club	
Smooth E.Piano	Sea Carnival	Unplugged	Slow & Easy	Five-Four	Theatre Organ	
2	60's Soul	Basic Waltz	Motor City	Euro Trance	Big Band Samba	Flamenco
	Classic Jazz Org	Brass Ensemble	Lovely Shuffle	6/8 Trance	Mambo Brass	Pop Flamenco
	Organ Band	Pure Waltz	Gospel Shuffle	Cool Hip Hop	Mambo Tenor	Mexican Dance
	Bump Organ	Rococo Ensemble	Joyful Gospel	Latin House	Montuno	Mariachi
	Kool Dist. Organ	Pop Cha Cha	Frankly Soul	Dance Beat	Bossa Nova	Celtic Dance
	Rock Dist. Organ	Comical Rumba	Soul	Euro Dance Pop	Pop Bossa	Folk Step
	Organ Funk	Comical Samba	Gospel	UK Pop	Sweet Rumba	Italiano
	Progressive Rock	Toy Orchestra	6/8 Soul	Jive	Beguine	Musette
	Lounge Organ	Charleston	Hit Pop	Disco Queen	Cha Cha Cha	Country
	60's Cheap Organ	Winter Swing	New Country	Disco Soul	Mellow Groove	Hawaiian
	Sunset Reggae	Snow Waltz 1	Eternal Pop	Pop Disco	Modern R&B	Chinese Nocturne
	Hard Rock Organ	Snow Waltz 2	Ground Beat	Hot Disco	Dixieland Jazz	Japanese Sound
3	70's Crossover	Alpine Polka *A	Bounce Pop *A	Ibiza *A	Jungle Drum *A	Orchestra March*A
	East Coast Brass	Alpine Polka *B	Bounce Pop *B	Ibiza *B	Jungle Drum *B	Orchestra March*B
	Fat Analog Synth	Alpine Polka *C	Bounce Pop *C	Ibiza *C	Jungle Drum *C	Orchestra March*C
	Club Jazz	Alpine Polka *D	Bounce Pop *D	Ibiza *D	Jungle Drum *D	Orchestra March*D
	Distor. Guitar	Dream Ballad *A	Blues Jam *A	Power House *A	Jazz Club *A	Pasodoble *A
	Tricky Guitar	Dream Ballad *B	Blues Jam *B	Power House *B	Jazz Club *B	Pasodoble *B
	Wow Guitar	Dream Ballad *C	Blues Jam *C	Power House *C	Jazz Club *C	Pasodoble *C
	Flange Clavi.	Dream Ballad *D	Blues Jam *D	Power House *D	Jazz Club *D	Pasodoble *D
	Pop Fusion Lead	Pops Orchestra*A	Evergreen Waltz*A	Dance Latino *A	Afro Session *A	Tango *A
	AOR Lead	Pops Orchestra*B	Evergreen Waltz*B	Dance Latino *B	Afro Session *B	Tango *B
	Sweet Fusion	Pops Orchestra*C	Evergreen Waltz*C	Dance Latino *C	Afro Session *C	Tango *C
	Retro Pop	Pops Orchestra*D	Evergreen Waltz*D	Dance Latino *D	Afro Session *D	Tango *D
4	Sweep Pad	Kids On Stage *A	16 Beat Pop *A	Twilight Disco*A	ChaCha Grandee*A	Show Time *A
	Pop Ballad	Kids On Stage *B	16 Beat Pop *B	Twilight Disco*B	ChaCha Grandee*B	Show Time *B
	Fat Pad	Kids On Stage *C	16 Beat Pop *C	Twilight Disco*C	ChaCha Grandee*C	Show Time *C
	Deep Pad	Kids On Stage *D	16 Beat Pop *D	Twilight Disco*D	ChaCha Grandee*D	Show Time *D
	Oriental Pad	Galaxy March *A	Top Gear Rock *A	Love Song *A	3/4 Fast Jazz *A	Majestic Sound*A
	Spacious Piano	Galaxy March *B	Top Gear Rock *B	Love Song *B	3/4 Fast Jazz *B	Majestic Sound*B
	70's Flute Pad	Galaxy March *C	Top Gear Rock *C	Love Song *C	3/4 Fast Jazz *C	Majestic Sound*C
	Screen Ballad	Galaxy March *D	Top Gear Rock *D	Love Song *D	3/4 Fast Jazz *D	Majestic Sound*D
	Brass Pad	SE *A	Southern Pop *A	Movie Ballad *A	Twilight Sax *A	Orchestra Swing*A
	Pop Rock Brass	SE *B	Southern Pop *B	Movie Ballad *B	Twilight Sax *B	Orchestra Swing*B
	Dance Brass	SE *C	Southern Pop *C	Movie Ballad *C	Twilight Sax *C	Orchestra Swing*C
	World Strings	SE *D	Southern Pop *D	Movie Ballad *D	Twilight Sax *D	Orchestra Swing*D

6 Confirming the Version of Your DDK-7

You can confirm the version of your DDK-7 by the following procedure.

- 1 Press the [UTILITY] button to call up the GLOBAL Page of the Utility Display.
- 2 Press the [Version] button in the display.
The Version dialog appears in the display. Pressing [OK] closes the dialog.

7 Factory Set (Initializing the DDK-7)

All current settings including Registration Memory, User Voices, User Rhythms, and LCD Display settings can be deleted at once by the following procedure. Be careful when executing Factory Set, since it erases all your existing data. Always save your important data to external media, such as USB flash memory.

Factory Set does not reset the Internet Direct Connection settings. If you want to reset the Internet Direct Connection settings, see page 221.



Reference Page

Saving Registrations
(page 116)



Reference Page

Initializing Internet Settings
(page 221)

- 1 Turn off the power.
- 2 While holding down the ENDING [1] button, turn the power back on.

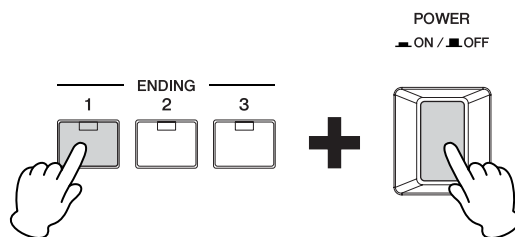

- 3 Release the ENDING [1] button after Voice Display appears.

If you don't want to reset the LCD Display settings, you can initialize only Registration settings. See page 93 for more information.



Reference Page

Initializing Registration
Memory (page 93)

2 Voices

2 Voices

The DDK-7 features hundreds of high quality Voices. Any of these Voices can be used on the Upper Keyboard and Lower Keyboard. If you connect the Pedal Unit to the DDK-7, you can use any of these voices also on the Pedalboard. Up to four Voice sections are available on the Upper Keyboard for playing together in a layer, while the Lower Keyboard and Pedalboard each have two Voice sections.

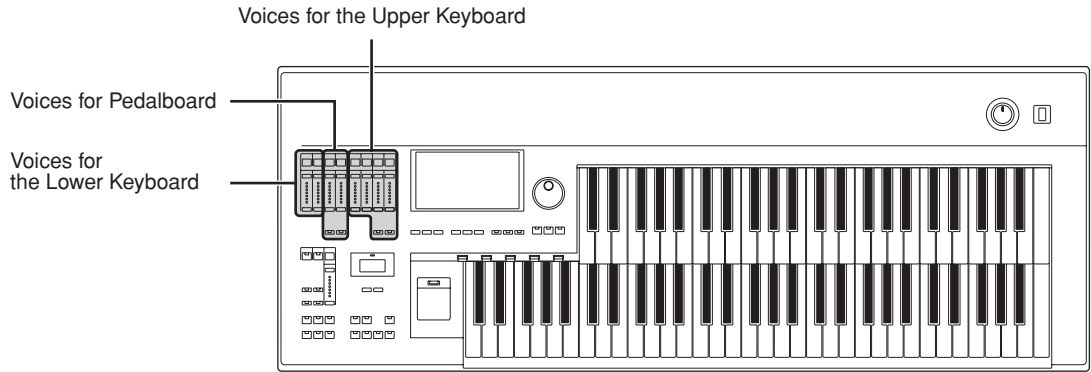

Contents

1 Voices for each keyboard24	3 Voice List32
2 Selecting Voices with the Voice buttons26		
• Selecting a Voice26		
• Changing the Voice volume27		

1 Voices for each keyboard

A total of 415 voices can be selected on the display which you can call up by pressing the Voice section buttons on the front panel.

Voices for the Upper Keyboard

Up to four different Voice sections are available on the Upper Keyboard for playing together: Upper Keyboard Voice 1, Upper Keyboard Voice 2, Lead Voice 1, and Lead Voice 2. Voices for each section can be selected from the panel.

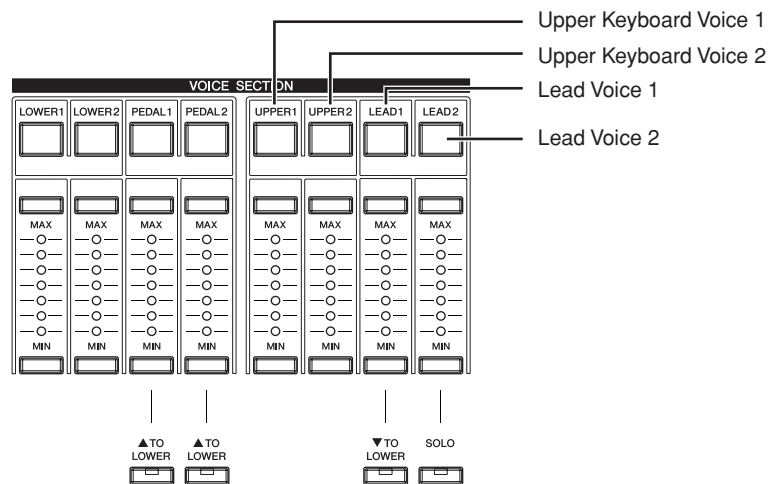

Lead Voice 1 and 2 sound only the highest note (or last note played) if two or more keys are played together. This makes the Lead Voices ideal for “lead” or solo instruments such as Trumpet and Saxophone.

Voices for the Lower Keyboard

Up to two different Voice sections are available on the Lower Keyboard for playing together: Lower Keyboard Voice 1 and Lower Keyboard Voice 2. Voices for each section can be selected from the panel.

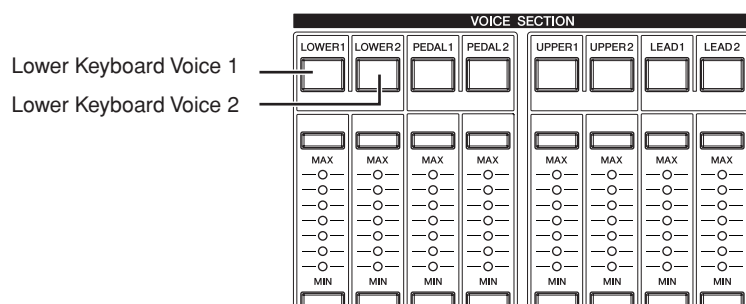

Voices for Pedalboard

Up to two different Voice sections are available on the Pedalboard for playing together: Pedal Voice 1 and Pedal Voice 2. Voices for each section can be selected from the panel. Pedal Voices 1 and 2 sound only the highest note if two or more pedals are played, by default.



Reference Page

POLY (page 42)

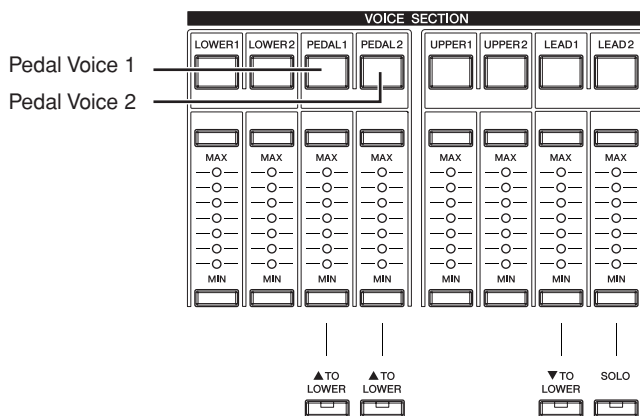

2 Selecting Voices with the Voice buttons

Since selection of Voices follows the same procedure throughout all Voice sections, instructions for only the Upper Keyboard Voice 1 (UPPER 1) are given here.

Selecting a Voice

1 Press the [UPPER 1] button.

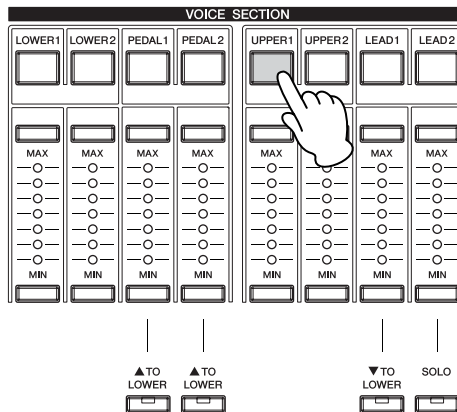

The voice menu of the currently selected category is shown in the display.

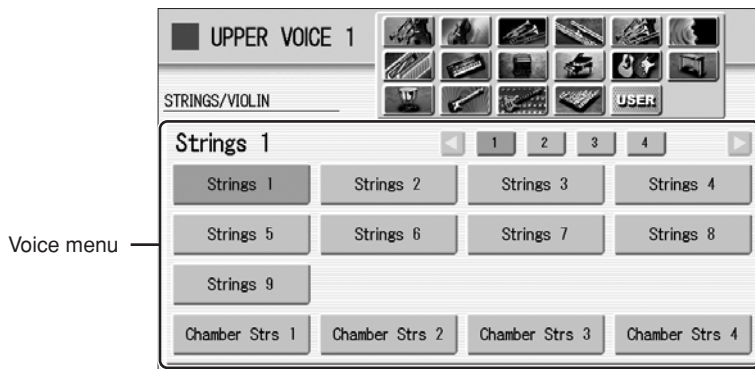

Reference Page
Voice Edit (page 137)

2 Select the desired instrument category with the category buttons in the display.

You can also choose the “User” category to select a User voice you have created.



For example, to call up Piano 1, select the Piano category.



The name of the selected category (Piano) is displayed on the upper left. The Voice name shown under the category name is that of the currently assigned Voice and is irrelevant to the Voice menu below.

3 Select the desired Voice name (Piano 1, for example) from the Voice menu.

The Voice menu contains many Piano Voices, more than can fit on one display page. To change the display pages, press the appropriate number buttons in the display.



Reference Page

Voice List (page 32)

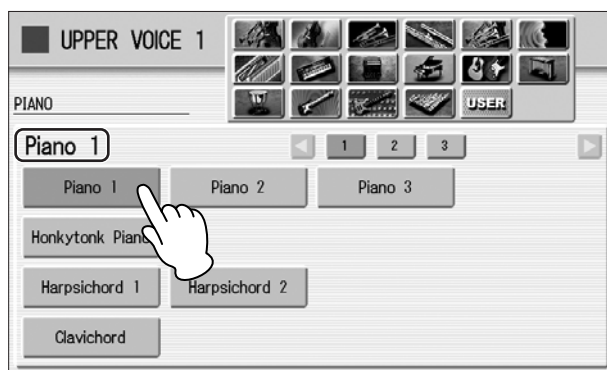

The color of the selected Voice name changes to orange, indicating that it has been selected.

Changing the Voice volume

There are two ways to set the Voice volume: using the VOLUME buttons on the panel and using the volume slider in the display. The VOLUME buttons let you make coarse adjustments to the volume while the slider gives you fine control.

Using the VOLUME buttons on the panel (coarse)

Press one of the VOLUME buttons of each Voice section on the panel to set the desired level for each Voice.

The buttons have seven volume settings, from a minimum of 0, or no sound, to a maximum of full volume.

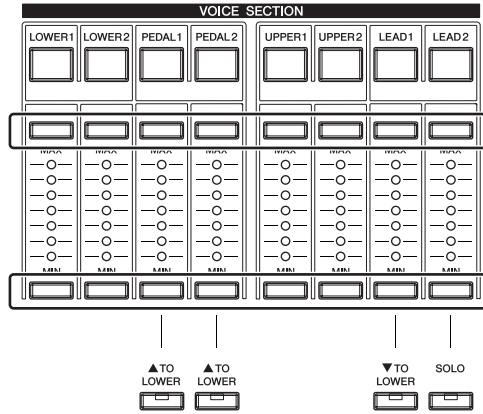

Using VOLUME slider in the display (fine)

Pressing the same Voice button on the panel again (or pressing the Voice name of the selected Voice in the display) calls up the Voice Condition Display.

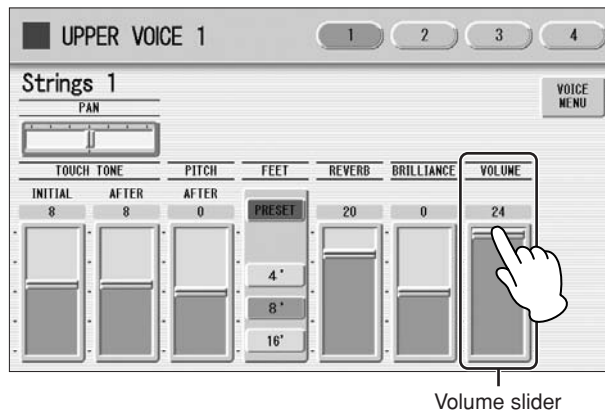

Volume slider



NOTE

Depending on the volume value (set by the slider), two adjacent VOLUME lamps may be lit at the same time, indicating an intermediate position.

To set the volume, touch the VOLUME slider in the display or use the Data Control Dial. The control range is from 0 (no sound) to 24 (full volume).

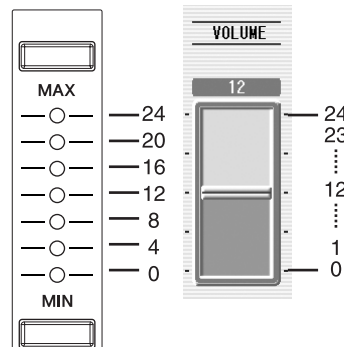

Pressing a Voice button once calls up the Voice Menu display. Pressing it a second time calls up the Voice Condition display. Successive presses alternate between the two displays.

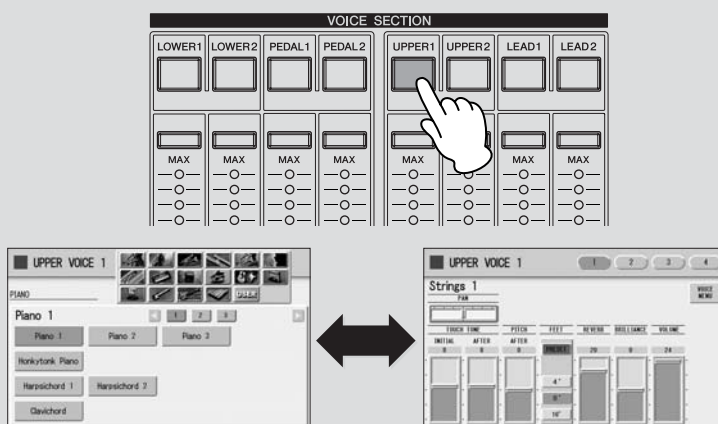

When the Voice Condition display is shown, pressing [VOICE MENU] button on the display also calls up the Voice Menu.

From the Voice Condition display, you can control Voice-related parameters such as Pan, Effect, Volume, and so on. For more information on the Voice Condition display, see page 41.



CAUTION

Turning the DDK-7 off erases all panel settings you have made.

If you wish to keep the panel settings you have made, save them to a USB flash memory or other external media before turning the DDK-7 off (page 92).

About the To Lower function

Voices selected for the Lead Voice 1, Pedal Voice 1, and Pedal Voice 2 sections can also be played on the Lower Keyboard when the [TO LOWER] button in each section is on. When [TO LOWER] is on, the Lead Voice and Pedal Voice cannot be played on the Upper Keyboard and Pedalboard, respectively.

The To Lower function is not available in the Lead Voice 2 section.

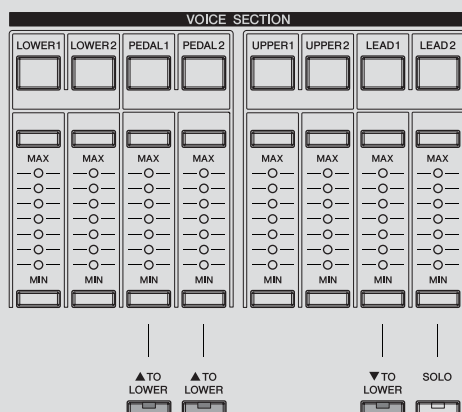



Reference Page

Foot Pedal (page 196)

About the Solo function

The Lead Voice 2 section features an exclusive Solo function. Solo lets you instantly switch to a solo Lead Voice in the middle of your performance, muting all other Upper Keyboard Voices. If you connect an optional Foot Pedal to the DDK-7, you can control the solo function without taking your hands from the keyboards.

1 Select the Voice that you wish to play solo in the Lead Voice 2 section.

In this condition, all the Voices for Upper Keyboard (Upper Keyboard Voice 1 and 2, and Lead Voice 1 and 2) can be played.

2 Press the [SOLO] button in the Lead Voice 2 section.

This sets Solo to standby status.

3 Press the [UTILITY] button to call up the Utility Display.

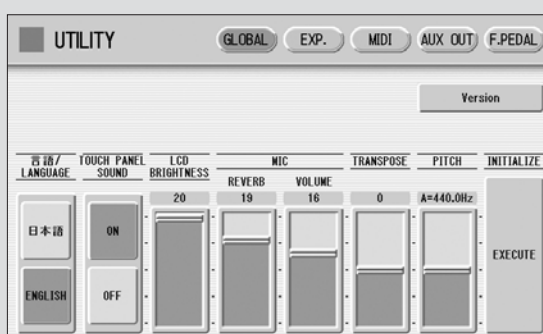
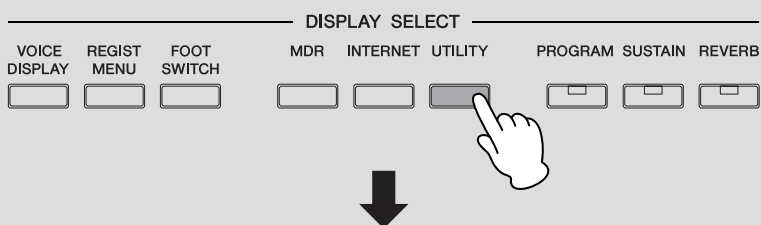

Press the [F. PEDAL] button at the top right of the display to call up the FOOT PEDAL Page.



4 Press the [SOLO] button in the display.

Select the [SOLO] button in the left side of the display if you are using the (1 VOLUME) of the FOOT PEDAL jacks, or select in the right side if you are using (2 SUSTAIN).

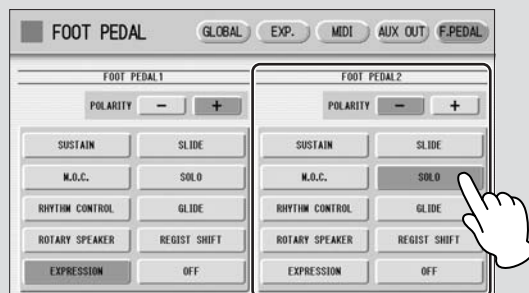

The Solo function is assigned to the Foot Pedal, and the polarity is selected automatically.

In this condition (Solo on), all Voices set to the Upper Keyboard except for Lead Voice 2 are playable on the Upper Keyboard.

5 To temporarily turn Solo on as you play, press the Foot Pedal and hold down.

In this condition, only the Lead Voice 2 is playable on the Upper Keyboard. (All other voices are muted.) Each time you press the Foot Pedal (Solo on) you can play only Lead Voice 2, and each time you release it (Solo off) you can play all Voices except Lead Voice 2 on the Upper Keyboard.

Notes on using Solo

- Some Registration Menu settings reverse the polarity of the Foot Pedal for the Solo function. In this condition, the situation described above is reversed. In other words, each time you press the Foot Pedal you can play all Voices except Lead Voice 2, and each time you release it you can play only Lead Voice 2 on the Upper Keyboard. To return the polarity to its original setting, press the [-] button in the display.
- Pressing the Foot Pedal while holding down a key will not turn Solo on for that key. Solo will active when the next key is played after pressing the Foot Pedal.
- Lead Voices 1 and 2 sound only the highest note if two or more keys are played. However, in the Solo mode, Lead Voice 2 sounds for the last key played.

3 Voice List

This list shows all available Voices on the DDK-7. Numbers written at the left side of each column in this list indicate the numbered buttons displayed in the Voice Menu.

Category/ Voice Name	Preset Feet	Preset Effect 1	Preset Effect 2
STRINGS/VIOLIN			
1 Strings 1	8'	THRU	THRU
Strings 2	8'	THRU	THRU
Strings 3	8'	AMBIENCE	THRU
Strings 4	8'	THRU	THRU
Strings 5	8'	THRU	THRU
Strings 6	8'	THRU	THRU
Strings 7	8'	DELAY LR	THRU
Strings 8	8'	THRU	THRU
Strings 9	8'	HM ENHANCER	THRU
Chamber Strs 1	8'	AMBIENCE	THRU
Chamber Strs 2	8'	THRU	THRU
Chamber Strs 3	8'	THRU	THRU
Chamber Strs 4	8'	HM ENHANCER	THRU
2 Pizzicato Strs 1	8'	THRU	ROOM S
Pizzicato Strs 2	8'	AMBIENCE	ROOM S
Pizzicato Strs 3	8'	AMBIENCE	ROOM S
Pizzicato Strs 4	8'	BASEMENT	ROOM S
Tremolo Strings	8'	AMBIENCE	THRU
3 Strings1&7	8'	THRU	THRU
Strings2&Viola	8'	THRU	THRU
Strings3&4	8'	AMBIENCE	THRU
Strings7&Violin5	8'	THRU	THRU
Violin5&Cello	8'	HM ENHANCER	THRU
Octave Strings 1	8'	THRU	THRU
Octave Strings 2	8'	THRU	THRU
4 Violin 1	8'	THRU	THRU
Violin 2	8'	AMBIENCE	THRU
Violin 3	8'	THRU	THRU
Violin 4	8'	THRU	THRU
Violin 5	8'	AMBIENCE	THRU
Violin 6	8'	AMBIENCE	THRU
Viola	8'	AMBIENCE	THRU
Cello 1	8'	RESONATOR	THRU
Cello 2	8'	THRU	THRU
Pizzicato Violin	8'	AMBIENCE	ROOM S
CONTRABASS			
1 Contrabass 1	8'	THRU	THRU
Contrabass 2	8'	THRU	THRU
Contrabass 3	16'/8'	THRU	THRU
Contrabass 4	8'	THRU	THRU
Contrabass 5	8'	AMBIENCE	THRU
Acoustic Bass 1	8'	AMBIENCE	THRU
Acoustic Bass 2	8'	HM ENHANCER	THRU
Pizzicato Bass 1	8'	THRU	THRU
Pizzicato Bass 2	8'	THRU	THRU

Category/ Voice Name	Preset Feet	Preset Effect 1	Preset Effect 2
BRASS/TRUMPET			
1 Brass Section 1	8'	THRU	THRU
Brass Section 2	8'	THRU	THRU
Brass Section 3	8'	THRU	THRU
Brass Section 4	8'	HM ENHANCER	THRU
Brass Section 5	8'	HM ENHANCER	THRU
Brass Section 6	8'	THRU	THRU
Trombone Sec 1	16'/8'	HM ENHANCER	THRU
Trombone Sec 2	16'/8'	THRU	THRU
Trombone Sec 3	16'/8'	THRU	THRU
Trombone Sec 4	16'/8'	AMBIENCE	THRU
Trombone Sec 5	16'/8'	THRU	HALL 1
2 Brass1&Trp6	8'	THRU	THRU
Brass2&Trp6	8'	ST 2BAND EQ	THRU
Horn 1&4	8'	ST 2BAND EQ	HALL 1
Octave Brass 1	8'	AMBIENCE	THRU
Octave Brass 2	8'	DELAY LR	THRU
Octave Brass 3	8'	THRU	THRU
Octave Brass 4	8'	THRU	THRU
Octave Brass 5	8'	THRU	THRU
Octave Brass 6	8'	THRU	THRU
Octave Brass 7	8'	ECHO	THRU
3 Trumpet 1	8'	THRU	THRU
Trumpet 2	8'	THRU	THRU
Trumpet 3	8'	THRU	THRU
Trumpet 4	8'	THRU	THRU
Trumpet 5	8'	HM ENHANCER	THRU
Trumpet 6	8'	THRU	THRU
Trumpet 7	8'	AMBIENCE	THRU
Muted Trumpet 1	8'	THRU	THRU
Muted Trumpet 2	8'	THRU	THRU
Muted Trumpet 3	8'	PHASER 1	THRU
Flugel Horn 1	8'	THRU	THRU
Flugel Horn 2	8'	THRU	THRU
4 Trombone 1	16'/8'	ST 2BAND EQ	THRU
Trombone 2	16'/8'	THRU	THRU
Trombone 3	16'/8'	THRU	THRU
Trombone 4	16'/8'	THRU	THRU
Muted Trombone 1	16'/8'	THRU	THRU
Muted Trombone 2	16'/8'	ST 3BAND EQ	PHASER 1

Category/ Voice Name	Preset Feet	Preset Effect 1	Preset Effect 2	
5	Horn 1	8'	THRU	THRU
	Horn 2	8'	THRU	THRU
	Horn 3	8'	THRU	THRU
	Horn 4	8'	THRU	THRU
	Horn 5	8'	THRU	THRU
	Horn 6	8'	THRU	THRU
	Muted Horn	8'	THRU	THRU
	6	Tuba 1	16'	ST 2BAND EQ
Tuba 2		16'/8'	THRU	THRU
Euphonium		16'/8'	THRU	THRU
Brass Bass 1		16'	THRU	THRU
Brass Bass 2		8'	THRU	THRU
Brass Bass 3		8'	THRU	THRU
WOODWIND/FLUTE				
1	Flute 1	8'	THRU	THRU
	Flute 2	8'	THRU	THRU
	Flute 3	8'	THRU	THRU
	Flute 4	8'	THRU	THRU
	Piccolo	4'	THRU	THRU
	Recorder 1	4'	THRU	THRU
	Recorder 2	4'	THRU	THRU
	Ocarina	4'	THRU	THRU
	Whistle	4'	ST 2BAND EQ	AMBIENCE
	2	Clarinet 1	8'	THRU
Clarinet 2		8'	THRU	THRU
Clarinet 3		8'	THRU	THRU
Clarinet 4		8'	THRU	THRU
Bass Clarinet		16'/8'	THRU	THRU
3	Oboe 1	8'	THRU	THRU
	Oboe 2	8'	THRU	THRU
	Oboe 3	8'	THRU	THRU
	Oboe 4	8'	THRU	THRU
	Oboe 5	8'	HM ENHANCER	THRU
	English Horn 1	8'	THRU	THRU
	English Horn 2	8'	THRU	THRU
	Bassoon 1	16'/8'	THRU	THRU
	Bassoon 2	16'/8'	THRU	THRU
	Bassoon 3	16'/8'	THRU	THRU
4	Alto Sax 1	16'/8'	HM ENHANCER	THRU
	Alto Sax 2	16'/8'	THRU	THRU
	Tenor Sax 1	16'/8'	THRU	THRU
	Tenor Sax 2	16'/8'	THRU	THRU
	Tenor Sax 3	16'/8'	THRU	THRU
	Soprano Sax 1	8'	THRU	THRU
	Soprano Sax 2	8'	THRU	THRU
	Baritone Sax	16'/8'	THRU	THRU

Category/ Voice Name	Preset Feet	Preset Effect 1	Preset Effect 2	
5	Sax Ens 1	16'/8'	THRU	THRU
	Sax Ens 2	16'/8'	THRU	THRU
	Sax Ens 3	16'/8'	THRU	THRU
	Woodwind Ens 1	8'	THRU	THRU
	Woodwind Ens 2	8'	THRU	THRU
	Woodwind Ens 3	8'	THRU	THRU
	Woodwind Ens 4	8'	THRU	THRU
	TUTTI			
1	Strings&Winds	8'	THRU	THRU
	Strings&Brass 1	8'	THRU	THRU
	Strings&Brass 2	8'	XG HM ENHNCE	THRU
	Strings&Horn	8'	THRU	THRU
	Brass&Sax 1	8'	THRU	THRU
	Brass&Sax 2	8'	THRU	THRU
	Brass&Sax 3	8'	THRU	THRU
	Brass&Winds	8'	THRU	THRU
2	Orchestra Hit	8'	THRU	THRU
CHOIR				
1	Choir 1	8'	THRU	THRU
	Choir 2	8'	THRU	THRU
	Choir 3	8'	THRU	THRU
	Choir 4	8'	THRU	THRU
	Choir 5	8'	THRU	THRU
	Choir 6	8'	THRU	THRU
	Choir 7	8'	THRU	THRU
	Choir 8	8'	THRU	THRU
	Choir 9	8'	THRU	THRU
2	Vocal	8'	XG HM ENHNCE	THRU
PAD				
1	Smooth Pad 1	8'	THRU	THRU
	Smooth Pad 2	4'	THRU	THRU
	Smooth Pad 3	8'	THRU	THRU
	Smooth Pad 4	8'	DELAY LR	THRU
	Smooth Pad 5	8'	DELAY LR	THRU
	Smooth Pad 6	8'	THRU	THRU
	Smooth Pad 7	4'	XG CHORUS 1	CROSS DELAY
	Smooth Pad 8	8'	XG CHORUS 1	XG HM ENHNCE
2	Resonance Pad 1	8'	ENS DETUNE	TEMPO CROSS
	Resonance Pad 2	8'	XG FLANGER 3	CROSS DELAY
	Resonance Pad 3	8'	ENS DETUNE	CROSS DELAY
	Resonance Pad 4	4'	CELESTE 2	DELAY LR
	Resonance Pad 5	8'	SYMPHONIC	DELAY LR
	Resonance Pad 6	8'	XG PCH CHG 1	CROSS DELAY
	Resonance Pad 7	8'	DELAY LR	PHASER 1
	Resonance Pad 8	8'	DELAY LR	TEMPO CROSS
	Resonance Pad 9	8'	V_FLANGER	ECHO
	Resonance Pad 10	8'	DELAY LR	XG CHORUS 1
	Resonance Pad 11	8'	COMPRESSOR	DELAY LR

Category/ Voice Name	Preset Feet	Preset Effect 1	Preset Effect 2
3	Bell Pad 1	8'	CELESTE 1 DELAY LR
	Bell Pad 2	8'	XG CHORUS 3 CROSS DELAY
	Bell Pad 3	8'	XG CHORUS 3 DELAY LR
	Bell Pad 4	8'	XG CHORUS 4 DELAY LR
	Bell Pad 5	8'	CHORUS 1 XG DLY LCR
	Bell Pad 6	8'	XG CHORUS 2 DELAY LR
	Bell Pad 7	8'	XG CHORUS 2 DELAY LR
	Bell Pad 8	8'	XG AT PAN 1 DELAY LR
	Bell Pad 9	4'	XG 3BAND EQ DELAY LR
4	Space Pad 1	8'	ENS DETUNE DELAY LR
	Space Pad 2	8'	XG FLANGER 1 DELAY LR
	Space Pad 3	8'	DELAY LR XG FLANGER 1
	Space Pad 4	16'	PITCH CHANGE DELAY LR
	Space Pad 5	8'	XG CHORUS 1 DELAY LR
	Space Pad 6	8'	V_FLANGER TALKING MOD
5	Noisy Pad 1	8'	ENS DETUNE DELAY LR
	Noisy Pad 2	8'	ENS DETUNE TALKING MOD
	Noisy Pad 3	8'	XG FLANGER 2 DELAY LR
	Noisy Pad 4	8'	ECHO XG FLANGER 2
	Noisy Pad 5	8'	EQ DISCO CANYON
SYNTH			
1	Synth Lead 1	8'	CELESTE 1 TEMPO DELAY
	Synth Lead 2	8'	ODRV+DELAY PHASER 1
	Synth Lead 3	8'	ER 1 DELAY LR
	Synth Lead 4	8'	XG CHORUS 4 THRU
	Synth Lead 5	8'	XG CHORUS 3 TEMPO CROSS
	Synth Lead 6	8'	XG CHORUS 4 XG DLY LCR
	Synth Lead 7	8'	GM CHORUS 3 DELAY LR
	Synth Lead 8	8'	V_DIST SOFT DELAY LR
2	Pop Lead 1	8'	ST 2BAND EQ TEMPO DELAY
	Pop Lead 2	8'	XG HM ENHNCE TEMPO CROSS
	Pop Lead 3	8'	CMP+OD+TDLY ENS DETUNE
	Pop Lead 4	8'	PITCH CHANGE TEMPO DELAY
	Pop Lead 5	8'	DELAY LR THRU
	Pop Lead 6	8'	XG HM ENHNCE ECHO
	Pop Lead 7	16'/8'	DELAY LCR THRU
3	Synth Cla 1	8'	ST 2BAND EQ TEMPO DELAY
	Synth Cla 2	8'	ENS DETUNE DELAY LR
	Synth Cla 3	8'	XG 3BAND EQ DELAY LR
	Synth Cla 4	8'	DELAY LR ENS DETUNE
	Synth Cla 5	8'	ENS DETUNE XG DLY LCR
	Synth Cla 6	8'	XG FLANGER 3 DELAY LR
	Synth Sax	8'	ST 2BAND EQ DELAY LR
	Synth Trumpet	8'	ST 2BAND EQ DELAY LR
	Synth Violin	8'	ST 2BAND EQ DELAY LCR

Category/ Voice Name	Preset Feet	Preset Effect 1	Preset Effect 2
4	Synth Brass 1	8'	PITCH CHANGE THRU
	Synth Brass 2	8'	THRU THRU
	Synth Brass 3	8'	THRU THRU
	Synth Brass 4	8'	ST 3BAND EQ THRU
	Synth Brass 5	8'	XG 3BAND EQ THRU
	Synth Brass 6	8'	XG 3BAND EQ XG CHORUS 4
	Synth Brass 7	8'	COMPRESSOR THRU
	Synth Brass 8	8'	ST 2BAND EQ DELAY LR
	Synth Brass 9	8'	CROSS DELAY THRU
	Synth Brass 10	8'	ENS DETUNE CROSS DELAY
	Synth Brass 11	8'	REVERS GATE DELAY LR
	Synth Brass 12	8'	ST 3BAND EQ TEMPO CROSS
	Synth Brass 13	8'	ST 2BAND EQ ENS DETUNE
5	Synth Strs 1	8'	ST 2BAND EQ XG CHORUS 1
	Synth Strs 2	8'	ST 3BAND EQ XG CHORUS 1
	Synth Strs 3	8'	XG CHORUS 1 CROSS DELAY
	Synth Strs 4	8'	XG 3BAND EQ XG CHORUS 1
	Synth Strs 5	8'	XG CHORUS 1 CROSS DELAY
	Synth Strs 6	8'	PHASER 1 ER 1
	Synth Strs 7	8'	XG CHORUS 1 CROSS DELAY
6	Synth Bell 1	8'	XG CHORUS 1 TEMPO DELAY
	Synth Bell 2	8'	XG PCH CHG 1 THRU
	Synth Bell 3	8'	ST 3BAND EQ TEMPO DELAY
	Synth Bell 4	8'	XG HM ENHNCE XG SYMPHONIC
	Synth Bell 5	8'	CROSS DELAY TUNNEL
	Synth Bell 6	8'	XG HM ENHNCE XG SYMPHONIC
	Synth Bell 7	8'	CROSS DELAY TUNNEL
	Synth Decay 1	8'	ST 2BAND EQ TEMPO CROSS
	Synth Decay 2	8'	ST 2BAND EQ ENS DETUNE
	Synth Decay 3	8'	AMBIENCE REVERS GATE
	Synth Decay 4	8'	HM ENHANCER AMP SIM
ORGAN			
1	Pipe Organ 1	8'	AMBIENCE THRU
	Pipe Organ 2	8'	THRU THRU
	Pipe Organ 3	8'	THRU THRU
	Pipe Organ 4	8'	THRU THRU
	Pipe Organ 5	8'	THRU THRU
	Harmonica 1	8'	THRU THRU
Harmonica 2	8'	ST 3BAND EQ THRU	
	Harmonica 3	8'	DELAY LR THRU

Category/ Voice Name	Preset Feet	Preset Effect 1	Preset Effect 2	
2	Theatre Organ 1	8'	TREMOLO 2 HM ENHANCER	
	Theatre Organ 2	8'	HM ENHANCER THRU	
	Theatre Organ 3	8'	GT TREMOLO 1 HM ENHANCER	
	Theatre Organ 4	8'	TREMOLO 2 HM ENHANCER	
	Theatre Organ 5	8'	TREMOLO 2 XG HM ENHNCE	
	Theatre Organ 6	8'	THRU THRU	
	Theatre Organ 7	8'	TREMOLO 2 THRU	
	Theatre Organ 8	8'	THRU XG HM ENHNCE	
	Accordion 1	8'	ST 3BAND EQ THRU	
	Accordion 2	8'	THRU THRU	
	Accordion 3	8'	THRU THRU	
	Accordion 4	8'	ST 3BAND EQ THRU	
	Bandoneon	8'	THRU THRU	
	Reed Organ	8'	THRU THRU	
	3	Jazz Organ 1	16'	2WAY ROT SP THRU
		Jazz Organ 2	16'	ROTARY SP 1 THRU
Jazz Organ 3		16'	TREMOLO 1 XG ROTARY SP	
Jazz Organ 4		16'	TREMOLO 1 ROTARY SP 1	
Jazz Organ 5		16'	ST 3BAND EQ BASEMENT	
Jazz Organ 6		16'	ST 3BAND EQ XG ROTARY SP	
Jazz Organ 7		16'	ST 2BAND EQ ROTARY SP 1	
Jazz Organ 8		16'	ST 2BAND EQ XG ROTARY SP	
Jazz Organ 9		16'	ST 3BAND EQ DUAL ROTSP 2	
4	Pop Organ 1	8'	ST 2BAND EQ TREMOLO 1	
	Pop Organ 2	8'	ST 3BAND EQ DUAL ROTSP 1	
	Pop Organ 3	8'	XG 3BAND EQ DUAL ROTSP 1	
	Pop Organ 4	8'	ST 2BAND EQ DIST+2ROT SP	
	Pop Organ 5	8'	XG PCH CHG 1 DIST+2ROT SP	
	Rock Organ 1	8'	ST 2BAND EQ ODRV+ROT SP	
	Rock Organ 2	8'	V_DIST SOFT DUAL ROTSP 2	
	Rock Organ 3	8'	COMP+DIST ROTARY SP 1	
5	Organ Bass 1	8'	THRU THRU	
	Organ Bass 2	16'	THRU THRU	
	Organ Bass 3	16'	THRU THRU	
	Organ Bass 4	16'	THRU THRU	
PIANO				
1	Piano 1	8'	THRU THRU	
	Piano 2	8'	XG HM ENHNCE THRU	
	Piano 3	8'	AMBIENCE THRU	
	Honkytonk Piano	8'	LO-FI ST 3BAND EQ	
	Harpsichord 1	8'	THRU THRU	
	Harpsichord 2	8'	THRU THRU	
Clavichord	8'	AMBIENCE THRU		

Category/ Voice Name	Preset Feet	Preset Effect 1	Preset Effect 2	
2	DX E.Piano 1	8'	CHORUS 2 THRU	
	DX E.Piano 2	8'	ENS DETUNE THRU	
	DX E.Piano 3	8'	ST 2BAND EQ CELESTE 4	
	DX E.Piano 4	8'	ST 2BAND EQ TEMPO CROSS	
	Stage E.Piano 1	8'	THRU THRU	
	Stage E.Piano 2	8'	ST 3BAND EQ CHORUS 1	
	Stage E.Piano 3	8'	ST 2BAND EQ EP AUTO PAN	
	Stage E.Piano 4	8'	ST 2BAND EQ PITCH CHANGE	
	Stage E.Piano 5	8'	XG TREMOLO XG CMP+DIST	
	Stage E.Piano 6	8'	ST 2BAND EQ EP PHASER 3	
	3	Stack E.Piano 1	8'	ST 2BAND EQ XG SYMPHONIC
		Stack E.Piano 2	8'	HM ENHANCER ENS DETUNE
Clavi 1		16'	THRU THRU	
Clavi 2		16'	ST 2BAND EQ TOUCH WAH 2	
GUITAR				
1	Nylon Guitar 1	16'/8'	THRU THRU	
	Nylon Guitar 2	16'/8'	ST 3BAND EQ THRU	
	Steel Guitar 1	16'/8'	ST 2BAND EQ HM ENHANCER	
	Steel Guitar 2	16'/8'	THRU THRU	
	12Str Guitar	16'/8'	ST 2BAND EQ XG HM ENHNCE	
	Jazz Guitar 1	16'/8'	THRU THRU	
	Jazz Guitar 2	16'/8'	THRU THRU	
	Harp 1	8'	THRU THRU	
	Harp 2	8'	THRU THRU	
	Harp 3	8'	ER 1 THRU	
2	Elec Guitar 1	16'/8'	ST 2BAND EQ SYMPHONIC	
	Elec Guitar 2	16'/8'	ST 2BAND EQ V_DIST SOFT	
	Elec Guitar 3	16'/8'	ST 2BAND EQ ST OVERDRIVE	
	Elec Guitar 4	16'/8'	ODRV+T DLY THRU	
	Elec Guitar 5	16'/8'	ST 2BAND EQ V_DIST SOFT	
	Muted Guitar	16'/8'	ST 2BAND EQ TEMPO DELAY	
	Distortion Gtr 1	16'/8'	ST 2BAND EQ WAH+OD+T DLY	
	Distortion Gtr 2	16'/8'	ST 3BAND EQ V_DIST H+TDLY	
	Distortion Gtr 3	16'/8'	ST 3BAND EQ DIST+T DLY	
	3	Banjo	8'	THRU THRU
Mandolin		8'	THRU THRU	
Pedal Steel Gtr		8'	THRU THRU	
PERCUSSION				
1	Vibraphone 1	8'	THRU THRU	
	Vibraphone 2	8'	HM ENHANCER AUTO PAN	
	Marimba 1	8'	THRU THRU	
	Marimba 2	8'	THRU THRU	
	Xylophone	4'	THRU THRU	
	Glockenspiel 1	4'	THRU THRU	
	Glockenspiel 2	4'	THRU THRU	

Category/ Voice Name	Preset Feet	Preset Effect 1	Preset Effect 2
2	Celesta 1	4'	HM ENHANCER THRU
	Celesta 2	4'	HM ENHANCER THRU
	Music Box 1	4'	THRU THRU
	Music Box 2	4'	HM ENHANCER STAGE 2
	Chime 1	4'	AMBIENCE THRU
	Chime 2	8'	AMBIENCE HALL L
	Chime 3	8'	ST 2BAND EQ PLATE 2
TIMPANI			
1	Timpani 1	8'	ST 2BAND EQ ER 1
	Timpani 2	8'	ST 2BAND EQ ER 2
	Timpani Roll 1	8'	ST 2BAND EQ ER 1
	Timpani Roll 2	8'	ST 2BAND EQ ER 2
	Timpani Roll 3	8'	ST 2BAND EQ ER 1
ELECTRIC BASS			
1	Fingered Bass 1	16'	THRU THRU
	Fingered Bass 2	8'	THRU THRU
	Fingered Bass 3	16'	THRU THRU
	Fingered Bass 4	16'	THRU THRU
	Fingered Bass 5	16'	THRU THRU
	Slap Bass 1	16'	THRU THRU
	Slap Bass 2	16'	THRU THRU
	Slap Bass 3	16'	ST 2BAND EQ XG PCH CHG 1
	Slap Bass 4	16'	M BAND COMP THRU
2	Picked Bass 1	16'	THRU THRU
	Picked Bass 2	16'	ST 2BAND EQ PITCH CHANGE
	Picked Bass 3	16'	THRU THRU
	Picked Bass 4	16'	THRU THRU
	Fretless Bass 1	16'	THRU THRU
	Fretless Bass 2	16'	ST 2BAND EQ PITCH CHANGE
SYNTH BASS			
1	Funk Bass 1	16'	THRU THRU
	Funk Bass 2	16'	THRU THRU
	Funk Bass 3	16'	THRU THRU
	Funk Bass 4	16'	ENS DETUNE THRU
	Funk Bass 5	16'	ST 2BAND EQ XG FLANGER 1
	Funk Bass 6	16'	ST 2BAND EQ ENS DETUNE
	Funk Bass 7	16'	ST 2BAND EQ XG HM ENHNCE
	Funk Bass 8	16'	THRU THRU
	Funk Bass 9	16'	ST 2BAND EQ ENS DETUNE
	Funk Bass 10	16'	ST 2BAND EQ PITCH CHANGE
2	Dance Bass 1	16'	THRU THRU
	Dance Bass 2	16'	THRU THRU
	Dance Bass 3	16'	THRU THRU
	Dance Bass 4	16'	ST 2BAND EQ HM ENHANCER
	Dance Bass 5	16'	ST 2BAND EQ ENS DETUNE
	Dance Bass 6	16'	ST 2BAND EQ ENS DETUNE
	Dance Bass 7	16'	THRU THRU
	Dance Bass 8	16'	HM ENHANCER FLANGER 1

Category/ Voice Name	Preset Feet	Preset Effect 1	Preset Effect 2
3	Smooth Bass 1	16'	ST 2BAND EQ PITCH CHANGE
	Smooth Bass 2	16'	THRU THRU
	Smooth Bass 3	16'	ST 2BAND EQ FLANGER 1
	Smooth Bass 4	16'	ST 2BAND EQ PITCH CHANGE
	Smooth Bass 5	16'	ST 2BAND EQ ENS DETUNE
	Smooth Bass 6	16'	THRU THRU
	Smooth Bass 7	16'	ST 2BAND EQ PITCH CHANGE
WORLD			
1	Pan Flute 1	8'	THRU THRU
	Pan Flute 2	8'	THRU THRU
	Bagpipe	8'	THRU THRU
	Dulcimer	8'	THRU THRU
	Shakuhachi	8'	THRU THRU
	Yokobue	4'	THRU THRU
	Shamisen	8'	THRU THRU
	Koto	8'	THRU THRU
	Taishokoto	4'	THRU THRU
2	Erhu 1	8'	HM ENHANCER THRU
	Erhu 2	8'	THRU THRU
	Sheng	8'	THRU THRU
	Zheng	8'	THRU THRU
	Pipa	8'	THRU THRU
	Nay	8'	THRU THRU
	Surnay	8'	THRU THRU
	Oud	8'	THRU THRU
	Sitar	8'	THRU THRU
	Kamanche	8'	THRU THRU
3	Steel Drum	8'	THRU THRU
	Log Drum	8'	THRU THRU
	Kalimba	8'	THRU THRU

3 Organ Flutes

The DDK-7 has an Organ Flutes feature that allows you to create your own organ Voices, giving you access to an unlimited combination of organ sounds. With this function, you can recreate all of the classic organ sounds by adjusting the flute footage levels and the percussive sounds, just like on conventional organs. There are nine flute footage settings, with three additional footage settings for the attack sound.

- 1 Press one of the Organ Flutes buttons (UPPER or LOWER).
The Flute Footage Levers appear on the display.

FOOTAGE Page

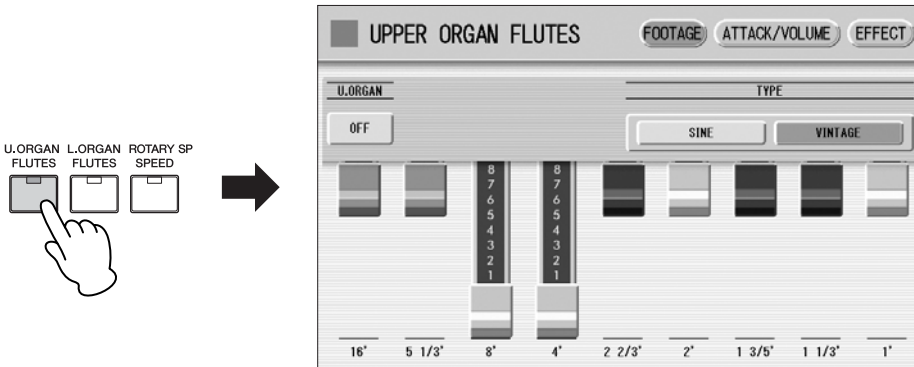

- 2 Press the ON/OFF button in the display to turn the Organ Flutes function on by selecting “ON”.

To turn off the Organ Flutes function, press the same button a second time to select “OFF”. The lamp of the [U. ORGAN FLUTES] or [L. ORGAN FLUTES] button on the panel lights up when the Organ Flutes function is on. The lamp turns off when the function is off.

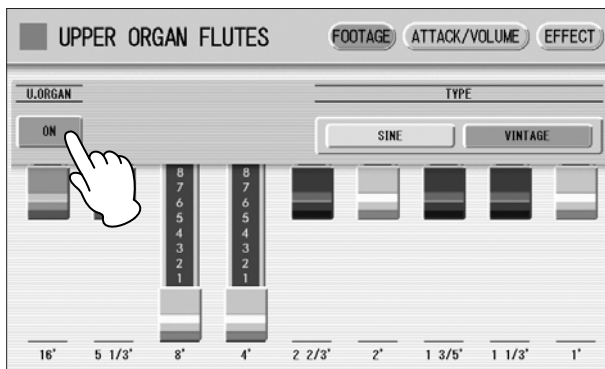

- 3 Select the wave type for the Organ Flute Voice.
Selecting [SINE] button produces a clean, clear sound and selecting [VINTAGE] produces a gritty, slightly distorted sound.

- 4 **Adjust flute footage settings (over a range of 0 – 8).**
The Flute footage levers can be adjusted by directly touching the display. The Data Control dial cannot be used. Play the keyboard and listen to the changes in the sound as you adjust the footage levels.
- 5 **Press the [ATTACK/VOLUME] button in the upper right on the display to adjust the volume and attack settings.**

ATTACK/VOLUME Page

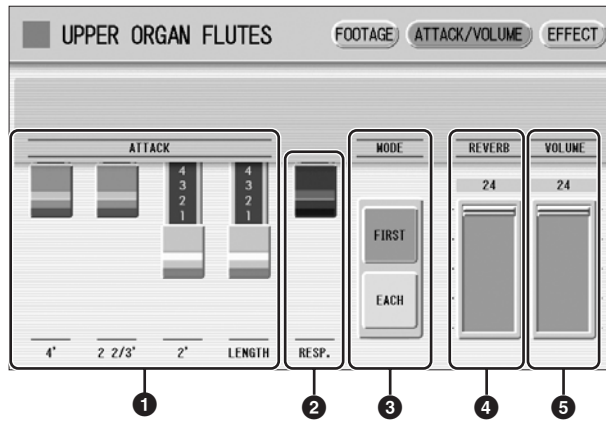

1 ATTACK

Determines the level of each volume in the percussive portion of the Voice. Footage settings are 4', 2-2/3' and 2'. The LENGTH lever determines the duration of the attack sound.

2 RESP. (Response)

Determines the overall speed of the keyboard response. Moving the lever downward makes the keyboard response slower, creating a pipe organ effect.

3 MODE

Determines which notes in a held group of notes are given an attack sound. This parameter is common to both Upper and Lower Organ Flute Voices.

FIRST: Only the first note played will have attack. All other notes played while the first is held have no attack.

EACH: All notes played have an attack sound.

4 REVERB

Determines the amount of reverb applied to the Organ Flute Voice. When the reverb depth in the REVERB Page 1 control is set to the minimum, the setting here will have no effect.

5 VOLUME

Determines the overall volume of the Organ Flute Voice. The volume balance of the individual footages is maintained. A minimum setting here produces no Organ Flute sound.



Reference Page

Reverb (page 46)

6 Press the [EFFECT] button in the upper right on the display to adjust the Rotary Speaker settings.

EFFECT Page

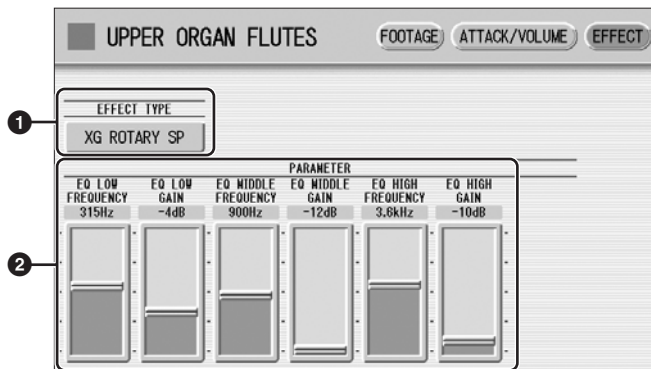

1 EFFECT TYPE

Select the Rotary Speaker (tremolo) effect type. Pressing the button for which the effect type (or “OFF”) is displayed calls up a list of the effect types. Select the desired type from among the list.



Reference Pages

Effect List (page 52)
Rotary Speaker (page 50)

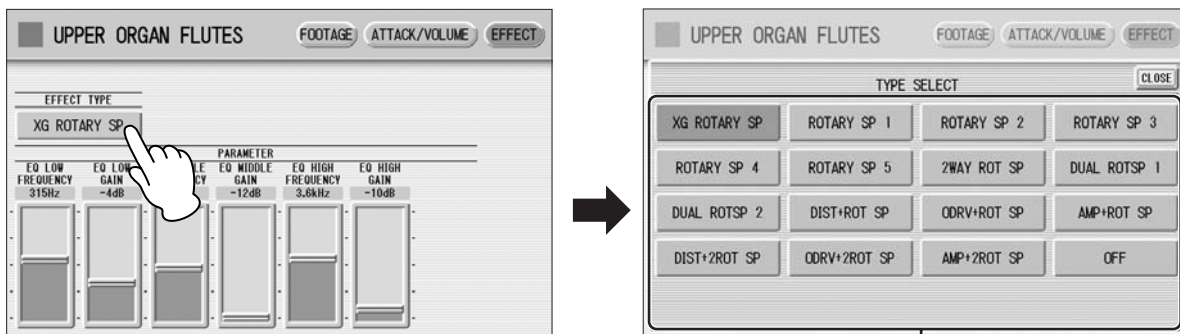

Select the desired effect type

2 EFFECT Parameters

Effect parameters are displayed corresponding to the selected effect type.

The DDK-7 is equipped with two general kinds of functions that can be used to change the sound of the Voices: Voice Controls and Effects.

Each Voice has been given certain factory-preset effect settings to best enhance its sound. However, if you wish, you can change the sound to suit your preferences by using the controls and effects described in this section. All built-in effects are digital.

The chart below shows the various Voice controls and effects for the individual Voice sections. Available functions are indicated by circles. The controls and effects are applied differently according to the different types: independently for each Voice section, independently for each keyboard or globally for the entire system.

Controls and Effects		Reference page for changing the settings	Voice sections to which the controls/effects are applied					
			Upper Keyboard		Lead Voice	Lower Keyboard		Pedalboard
			Upper Keyboard Voice 1, 2	Organ Flute Voice	Lead Voice 1, 2	Lower Keyboard Voice 1, 2	Organ Flute Voice	Pedalboard Voice 1, 2
Selecting from the Voice Condition display	Pan	page 41	○	—	○	○	—	○
	Touch Tone	page 41	○	—	○	○	—	○
	Pitch	page 42	○	—	○	○	—	○
	Feet	page 42	○	—	○	○	—	○
	Reverb (send level)	page 42	○	○	○	○	○	○
	Brilliance	page 42	○	—	○	○	—	○
	Volume	page 42	○	○	○	○	○	○
	Priority*	page 42	—	—	○*	—	—	—
	Poly (Pedal polyphonic mode)	page 42	—	—	—	—	—	○
	Vibrato	page 43	○	—	○	○	—	○
	Touch Vibrato	page 44	○	—	○	○	—	○
	Lead Slide	page 44	○	—	○	—	—	—
	Transpose	page 44	○	—	○	○	—	○
	Tune	page 44	○	—	○	○	—	○
Effect (1, 2)	page 45	○	—	○	○	—	○	
Selecting from the panel	Reverb	page 46	○					
	Sustain	page 49	○	○	○	○	○	○
	Rotary Speaker	page 50	○					

* Priority is applied only for Lead Voice 2.

Contents

1 Selecting from the Voice Condition display	41
2 Selecting from the panel	46
3 Effect List	52

1 Selecting from the Voice Condition display

Choose a Voice on the panel, then press the same button on the panel again (or press the name of the selected Voice in the display). The Voice Condition display appears. Voice Condition Display for each Voice has four pages that can be switched by pressing [1] – [4] buttons at the top right of the display.

Voice Condition [Page 1]

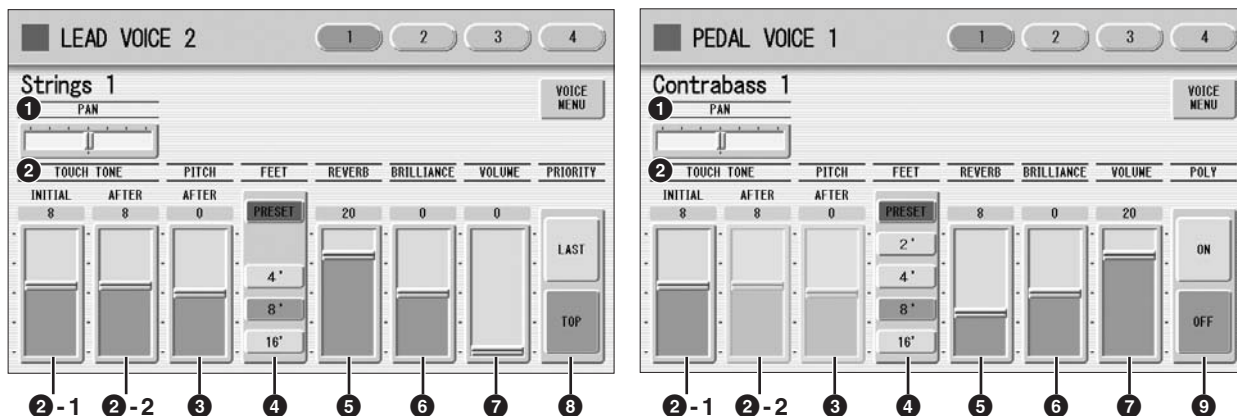

In this display, you can adjust the basic Voice controls, including panning, touch tone and volume. The displays of the various Voice sections have slight differences in their functions.

1 PAN

Determines the position of the Voice in the stereo image. Seven pan positions are available.

2 TOUCH TONE

The Touch Tone function gives you expressive control over the volume and timbre of a Voice. All Voices are provided with this expressive function, making it possible to perfectly reproduce the subtle dynamic and tonal changes of actual instruments. Two types of keyboard touch affect this function: Initial Touch and After Touch.

2 -1 INITIAL touch

Controls volume and timbre according to the velocity at which you play the keys. The harder you play the keys, the greater the volume and the brighter the timbre will become.

Higher settings make the change wider. Minimum setting produces no effect.

Range: 0 – 14

2 -2 AFTER touch

Controls volume and timbre according to the pressure you apply to the keys after playing them.

The harder you press down on the keys, the greater the volume and the brighter the timbre will become.

Higher settings make the change wider. Minimum setting produces no effect.

Range: 0 – 14



NOTE

Initial Touch may not be effective on some organ Voices.



NOTE

After Touch is not applied to the Pedal Voices.



NOTE

After Touch has no effect on percussive Voices (such as piano or vibraphone), percussion sounds, or some organ Voices.

3 PITCH

Controls pitch according to the play style of After Touch.

AFTER touch

Controls the pitch according to the pressure you apply to the keys after playing them.

The minimum setting produces no effect at all. Higher (positive) settings make the pitch higher according to the pressure and lower (negative) settings make the pitch lower. The setting of +14 or -14 results in the widest pitch change.

Range: -14 – +14

4 FEET

Determines the octave setting of the Voice, letting you use the Voice over a wide register. There are three settings: 4', 8' and 16' (4' is highest and 16' is lowest). A 2' setting is added to the Pedal Voice sections. PRESET is the original (factory) setting.

5 REVERB

Determines the amount of reverb applied to each Voice section. When the REVERB control in the Reverb Page 1 is set to the minimum, the setting here will have no effect. See page 46 for details.

6 BRILLIANCE

Adjustment of the Voice tone, brighter or mellower. Range is from -3 to +3. Higher settings makes the voice tone brighter.

7 VOLUME

Fine adjustment of the Voice volume. See page 28 for more information.

8 PRIORITY (only for the Lead Voice 2)

Determines the mode of Lead Voice 2, Last or Top.

LAST: Only the last played key is sounded when two or more keys are played simultaneously.

TOP: Only the highest note is sounded when two or more keys are played simultaneously. When the Solo mode is on, Lead Voice 2 sounds according to Last mode, regardless of the setting made here.



Reference Page

Solo function (page 30)

9 POLY (only for Pedal Voices)

Allows you to switch the pedal polyphonic mode on or off. Setting POLY to on switches the normally monophonic pedal Voices to polyphonic play. This makes it possible to play the Pedalboard in various expressive ways, such as playing legato or playing intervals and chords.

Keep in mind that you cannot exceed the total maximum polyphony: 14 notes for all sections, Upper, Lower and Pedal.

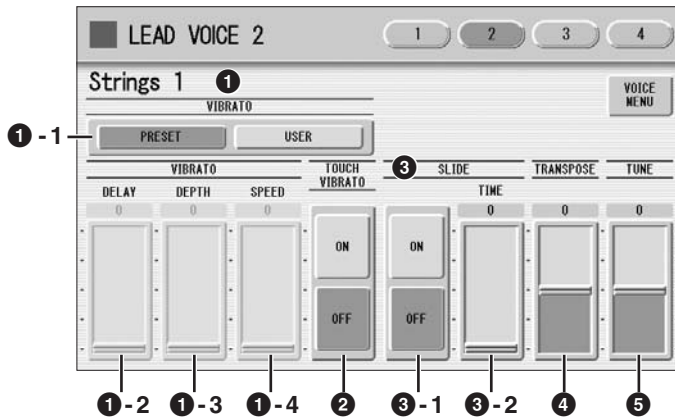

The items included in this page differ between the Lead Voice sections and the other sections. SLIDE (3) only applies to Lead Voice 1 and 2.

1 VIBRATO

The Vibrato function wavers the level of the Voices, making them sound warmer and more animated. This effect is applied independently to each Voice section. For some Voices, vibrato may not be effective at all or the effect may not sound as expected.

1 - 1 PRESET/USER

Selecting PRESET calls up the original (factory) vibrato settings for the Voice. When PRESET is selected, DELAY, DEPTH and SPEED parameters cannot be edited. Selecting USER lets you adjust the vibrato settings for yourself.

Vibrato Control

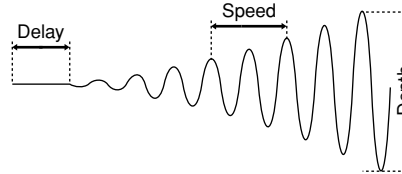

1 - 2 DELAY

Determines the amount of time that elapses between the playing of a key and the start of the vibrato effect. Higher settings increase the delay of the vibrato onset.

Range: 0 – 14

1 - 3 DEPTH

Determines the intensity of the vibrato effect. Higher settings result in a more pronounced vibrato. The minimum setting cancels the vibrato effect.

Range: 0 – 14

1 - 4 SPEED

Determines the speed of the vibrato effect. Higher settings increase the speed of the vibrato.

Range: 0 – 14

**NOTE**

Touch Vibrato is not applied to the Pedal Voices.

2 TOUCH VIBRATO

Turns the Touch Vibrato function on or off. Setting Touch Vibrato to on lets you apply vibrato to individual notes as you play them by after touch. The harder you press down the key, the greater the vibrato will be. When Touch Vibrato is off, vibrato depth cannot be controlled, no matter how hard you press the keys.

**Reference Page**

Controlling Lead Slide (with Foot Pedal); (page 199)

3 SLIDE (only for Lead Voices)

Applies a portamento effect to notes played in legato. The Slide function is effective within a one-octave range for Lead Voices. Slide has no effect when playing notes beyond a one-octave range. By connecting an optional Foot Pedal to the DDK-7, you can use it to control the slide function.

3 - 1 ON/OFF

On/Off switch the Slide effect.

3 - 2 TIME

Determines the speed of the slide or portamento effect. Higher settings makes the slide speed slower.

Range: 0 – 14

**Reference Page**

Transpose (for entire instrument); (page 208)

4 TRANSPOSE

Changes the pitch in semitones for each Voice section. Range is from -6 to +6.

**Reference Page**

Pitch (for entire instrument); (page 208)

5 TUNE

Determines the fine pitch settings (detune) for each Voice section, producing a richer sound. Each step represents a 1-cent change in pitch.

Range: -64 – +63

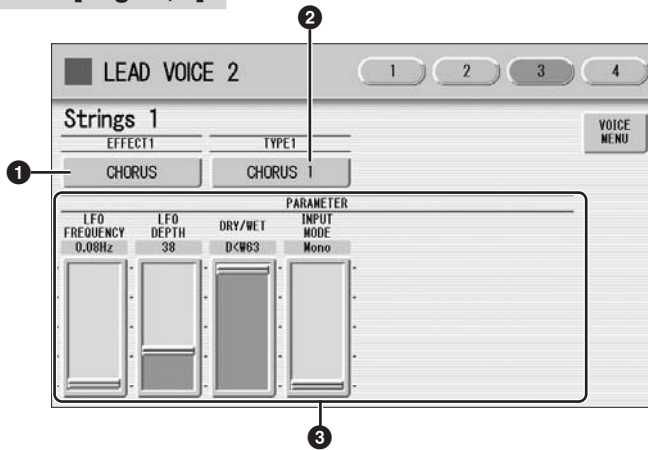

You can edit the effect parameters from these two displays. Both displays have the same contents. You can select two effects for each Voice section with these displays (Voice Condition Pages 3 and 4).

1 EFFECT 1 (Page 3)/EFFECT 2 (Page 4)

Selects the effect category. Pressing the effect button on the display calls up the effect category list. Select the desired effect category in the list.



Reference Page

Effect List (page 52)



By selecting [PRESET] in the list, the original (factory) effect category for the selected Voice is automatically set. Selecting [THRU] bypasses the effect (no effect is added to the selected Voice).

2 TYPE 1 (Page 3)/TYPE 2 (Page 4)

Determines the type of the effect. Pressing the TYPE button on the display calls up the effect type list, corresponding to the selected effect category. Select the desired effect type in the list.

If you have selected the [PRESET] category, the effect type cannot be edited.

After changing the effect type, the effect parameter below is automatically changed corresponding to the selected effect type.

3 Effect Parameters

Effect parameters are displayed corresponding to the selected effect type.

2 Selecting from the panel

The Reverb, Sustain and Rotary Speaker displays are called up by pressing the respective buttons on the panel.

Reverb

Reverb adds an echo-like effect to the sound, giving the impression of a performance in a large room or concert hall. You can adjust the reverb volume for each Voice sections, or adjust the reverb volume for rhythm and accompaniment separately.

To adjust the reverb effect and call up the Reverb pages:

Press the REVERB button, located to the left of the panel, to set the Reverb effect. The Reverb display appears.

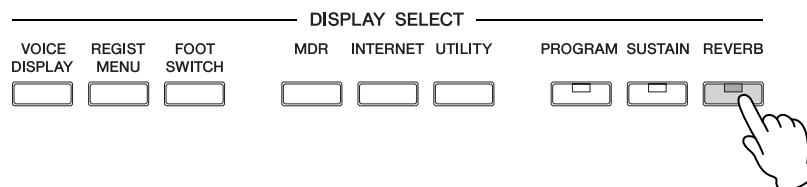

The Reverb display consists of four pages.

REVERB [Page 1]



DEPTH:

Fine adjustment of the depth of reverberation or the level of the reflected sounds. When this parameter is set to the minimum, the settings in the pages that follow have no effect.

Range: 0 – 24

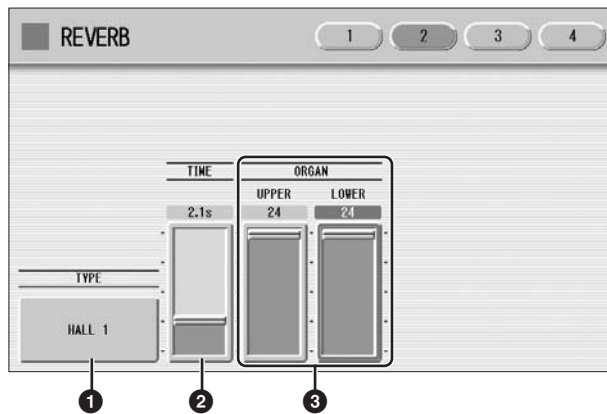

1 TYPE

Determines the reverb type for each of the Voice sections and the Organ Flute Voice. Several types can be selected: Room, Hall, Stage, and so on. Pressing the TYPE button on the display calls up the Reverb Type list.



Reference Page

Effect List (page 52)

Press the number buttons to change the display pages.

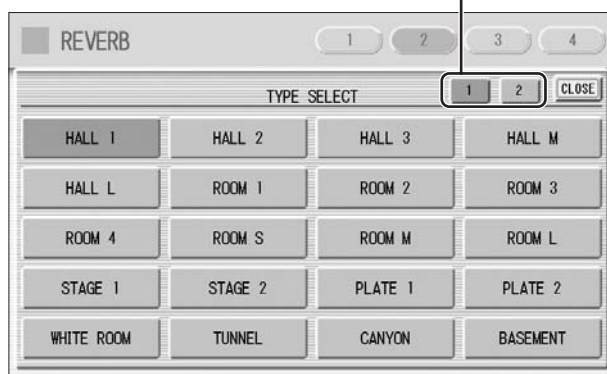

The list contains many reverb types, more than can fit on one display page. To change the display pages, press the appropriate number buttons [1] or [2] in the display. Select the desired reverb type in the list. After changing the reverb type, the TIME parameter below is automatically changed corresponding to the selected reverb type.

2 TIME

Determines the reverb length for each of the Voice sections and the Organ Flute Voice. Higher settings increase the reverberance.

Range: 0.3s – 30.0s

3 ORGAN

Determines the amount of reverb applied to the Organ Flute Voice. This parameter corresponds to the REVERB slider contained in the ATTACK/VOLUME Page of the Organ Flute display.

Range: 0 – 24



Reference Page

Organ Flutes (page 37)

REVERB [Page 3]

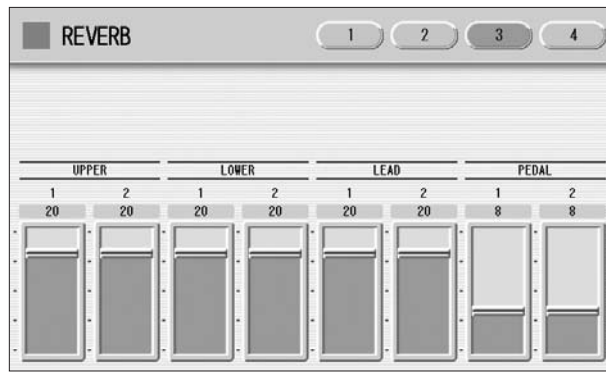

Determines the amount of reverb effect applied to each Voice section. Each slider corresponds to the REVERB slider in Voice Condition Page 1 of the respective Voices.

Range: 0 – 24

REVERB [Page 4]

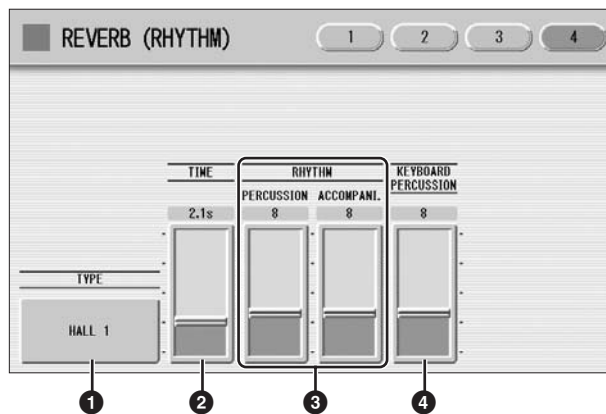

Reference Page

Connecting a Microphone
(page 232)

1 TYPE

Determines the reverb type for rhythm, accompaniment, keyboard percussion, and microphone signal.

2 TIME

Determines the length of reverb applied to the rhythm, accompaniment, keyboard percussion, and microphone signal.

Range: 0.3s – 30.0s

3 RHYTHM

Determines the amount of reverb applied to the rhythm (with PERCUSSION slider) and accompaniment (with ACCOMPANI. slider). Each slider corresponds to the REVERB slider in the Rhythm Condition display.

Range: 0 – 24

4 KEYBOARD PERCUSSION

Determines the amount of reverb applied to the Keyboard Percussion.

Range: 0 – 24



Reference Pages

Changing the rhythm reverb
(page 67)
Keyboard Percussion
(page 74)

Sustain

The sustain effect, selectable for the each Voice section, causes Voices to gradually fade out when the keys are released. The sustain on/off and sustain length settings are independent for each Voice section, providing maximum expressive control. The optional Foot Pedal can also be used to switch sustain on/off for voice sections other than Pedal Voice 1 and 2.

 **Reference Page**
Foot Pedal (page 196)

To add sustain to the Voices and call up the Sustain page:

Press the SUSTAIN button, located to the left of the panel, to set the sustain. The Sustain display appears.

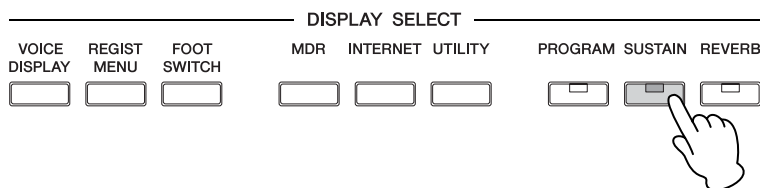

The Sustain display consists of two pages.

SUSTAIN Display

Switches the sustain function on/off

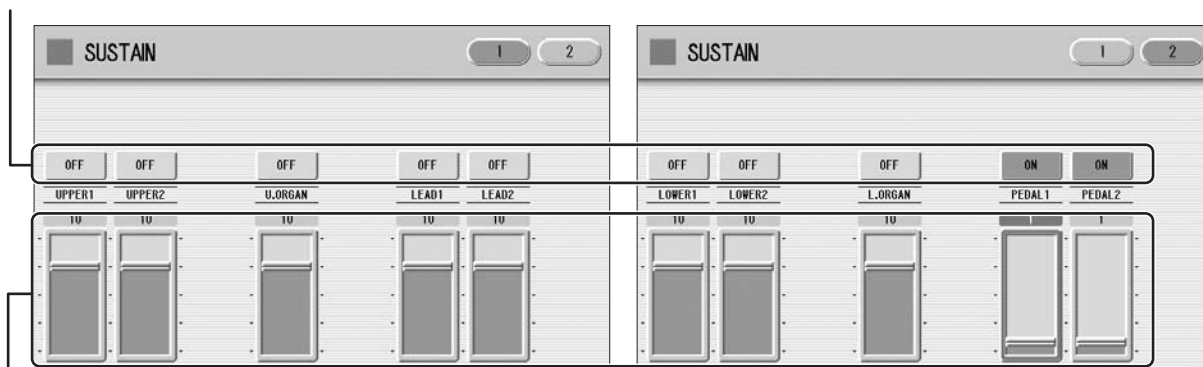

Sustain length value

The display shows the on/off status and the current sustain length values for each Voice section. The values here must be set high enough for the sustain effect to be noticeable.

Press the ON/OFF button in the display to select “ON” above the Voice section name for which you want to apply sustain. To turn sustain off, press the same button a second time to select “OFF”.

To adjust the sustain length value, use the display sliders. If you set the highest value (HOLD), some Voices such as organ or synth will sound continuously even when the keys are released.

The lamp of the [SUSTAIN] button lights up when you turn on the Sustain effect for one of the Voice sections in the Sustain display. When you turn off the Sustain effect for all Voice sections in the Sustain display, the lamp turns off. Remember to check whether the sustain effects are on or off in the Sustain display before you start to play.

Range: 0 – 12, HOLD

Rotary Speaker

Rotary Speaker recreates the rich, swirling sound of the popular rotating speaker effect. The Rotary Speaker effect can be switched in real time as you play, with either the front panel button. The Rotary Speaker effect CANNOT be turned on only by turning on the [ROTARY SP SPEED] button. The following procedure is needed to use the Rotary Speaker effect.

1 Select the Rotary Speaker effect from the desired Voice.

When you want to set Rotary Speaker to one of the Voice section, you can select the effect category of Rotary Speaker in the Voice Condition Display Page 3 or 4. See page 45 for details.

Select "Rotary Speaker" here.

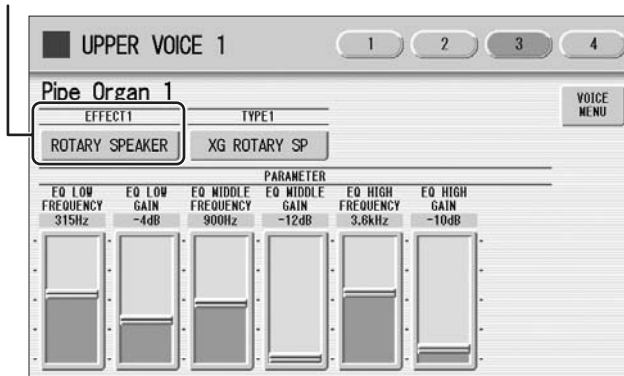

When you want to set Rotary Speaker for the Organ Flute Voice, select the effect type in the EFFECT Page. See page 39 for details.

Select an effect type other than [OFF].

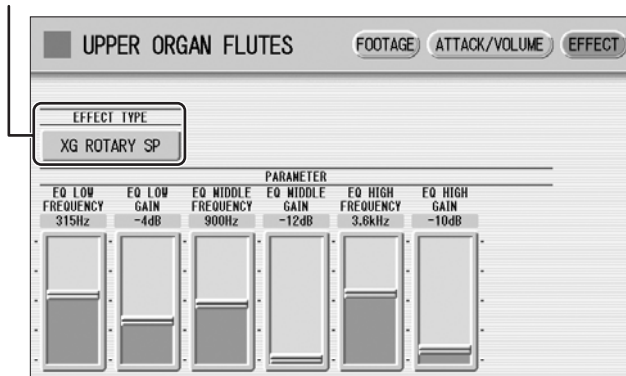

2 Adjust the rotating speed and mode of the Rotary Speaker.

Press the [ROTARY SP SPEED] button on the panel.

The ROTARY SPEAKER display appears. The settings in this display are common to all Voice sections.

ROTARY SPEAKER Display

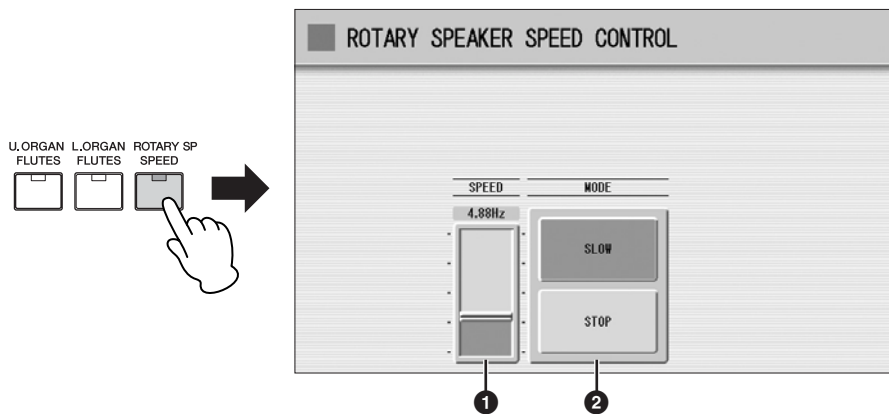

1 SPEED

Determines the speed of the speaker rotation.

Range: 2.69Hz – 39.7Hz

2 MODE

Determines the slow/stop mode when [ROTARY SP SPEED] button is off. If [SLOW] is selected, a slow chorus effect is applied when you turn off the button on the panel. If [STOP] is selected, the Rotary Speaker effect turns off when you turn off the button on the panel.

Once the Rotary Speaker effect has been turned on and set, you can control the effect in real time from the panel.

3 Control the Rotary Speaker effect from the panel.

You can control Rotary Speaker on/off from the panel. An optional Foot Pedal, or the Footswitch on the Pedal Unit can also be used to switch the effect on/off. See page 196 for details.



Reference Page

Footswitches (page 193)
Foot Pedal (page 196)

3 Effect List

REVERB

Produces a gentle “wash” of aftertones in the sound, recreating the subtle ambience and depth of actual performance spaces and rooms.

Effect Type	Effect Type
HALL 1	PLATE 2
HALL 2	WHITE ROOM
HALL 3	TUNNEL
HALL M	CANYON
HALL L	BASEMENT
ROOM 1	XG HALL 1
ROOM 2	XG HALL 2
ROOM 3	XG ROOM 1
ROOM 4	XG ROOM 2
ROOM S	XG ROOM 3
ROOM M	XG STAGE 1
ROOM L	XG STAGE 2
STAGE 1	XG PLATE
STAGE 2	GM PLATE
PLATE 1	

Parameter	Value	Description
Time	0.3 - 30.0 s	Determines the decay time of the reverb.
Dry/Wet	D63>W - D<W63	Determines the balance of the original sound (dry) and the effect sound (wet).

DELAY

Produces delayed distinct repeats of the sound, or echoes. This is also useful for creating rhythmic repeats in the sound.

Effect Type
DELAY LCR
XG DLY LCR
DELAY LR
ECHO
CROSS DELAY
TEMPO DELAY
TEMPO ECHO
TEMPO CROSS

Parameter	Value	Description
L DelayTime	0.1 - 1486.0 msec Echo: 0.1 - 371.5 msec	Determines the time that elapses between the original sound and the delayed repeat in the left channel.
R DelayTime	0.1 - 1486.0 msec Echo: 0.1 - 371.5 msec	Determines the time that elapses between the original sound and the delayed repeat in the right channel.
C DelayTime	0.1 - 1486.0 msec Echo: 0.1 - 371.5 msec	Determines the time that elapses between the original sound and the delayed repeat in the center of the stereo image.
L>R Delay Time	0.1 - 743.0 msec	Determines the time for the sound to move from left to right (when using Cross Delay).
R>L Delay Time	0.1 - 743.0 msec	Determines the time for the sound to move from right to left (when using Cross Delay).
DelayTime	32th - 4th	When using Tempo Delay, this sets the time between delayed repeats to match the tempo of the rhythm/song.
InputSelect	L, R, L&R	Determines the input configuration.
Feedback Delay Time	0.1 - 1486.0 msec	Determines the feedback time of the delayed repeats. The larger the value, the longer the time between delayed repeats. (For Delay LR, the left and right channels can be set independently.)
Feedback Delay 1	0.1 - 1486.0 msec	Determines the first feedback delay time of the L/R delay.
Feedback Delay 2	0.1 - 1486.0 msec	Determines the second feedback delay time of the L/R delay.
Feedback Level	-63 - +63	Determines the amount of delayed repeats in the sound. When this is set to 0%, the delayed repeat from the second time will not sound.
L Feedback	-63 - +63	Determines the feedback level in the left channel.
R Feedback	-63 - +63	Determines the feedback level in the right channel.
Dry/Wet	D63>W - D<W63	Determines the balance of original sound and the effect sound.

ER/KARAOKE

Produces early reflections without the subsequent reverb, or a deep echo effect like that used in Karaoke sing-along applications.

Effect Type
ER 1
ER 2
GATE REVERB
REVERS GATE
KARAOKE 1
KARAOKE 2
KARAOKE 3

Parameter	Value	Description
Type	S-H, L-H, Rdm, Rvs, Plt, Spr	Determines the early reflection type. The response of the early reflections varies depending on the type.
Room Size	0.1 - 7.0	Determines the room size. The higher the value the longer the ER.
Type	Type A, Type B	Determines the reverse gate type.
DelayTime	0.1 - 400 msec	Determines the time that elapses between the original sound and the delayed repeat.
Feedback Level	-63 - +63	Determines the amount of delayed repeats in the sound. When this is set to 0%, the delayed repeat from the second time will not sound.
Dry/Wet	D63>W - D<W63	Determines the balance of the original sound and effect sound.

CHORUS

Creates a warm effect as if several of the same sound were playing at once. Makes the overall sound richer, “fatter” and more animated.

Effect Type	Effect Type
CHORUS 1	GM CHORUS 4
CHORUS 2	FB CHORUS
XG CHORUS 1	CELESTE 1
XG CHORUS 2	CELESTE 2
XG CHORUS 3	CELESTE 3
XG CHORUS 4	CELESTE 4
GM CHORUS 1	SYMPHONIC
GM CHORUS 2	XG SYMPHONIC
GM CHORUS 3	ENS DETUNE

Parameter	Value	Description
LFO Freq.	0.00 - 39.7 Hz	Determines the frequency of oscillation, or the speed of the wavering effect.
LFO Depth	0 - 127	Determines the depth of oscillation, or the amount of the wavering effect.
Input Mode	Mono, Stereo	Determines the input configuration.
Detune	-50 - +50 cent	Determines the amount of detuning (or pitch shifting) is applied to the delayed repeats.
L DelayTime	0.0 - 50.0 msec	Determines the time that elapses between the original sound and the delayed repeat in the left channel.
R DelayTime	0.0 - 50.0 msec	Determines the time that elapses between the original sound and the delayed repeat in the right channel.
Dry/Wet	D63>W - D<W63	Determines the balance of the original sound and the effect sound.

FLANGER

This creates a metallic periodic “sweeping” effect, similar to Chorus but with a brighter more resonant sound.

Effect Type
FLANGER 1
FLANGER 2
XG FLANGER 1
XG FLANGER 2
XG FLANGER 3
GM FLANGER
V_FLANGER
TEMP FLANGER
DYNA FLANGER

Parameter	Value	Description
LFO Freq.	0.00 - 39.7 Hz	Determines the frequency of oscillation, or the speed of the wavering effect.
LFO Depth	0 - 127	Determines the depth of oscillation, or the amount of the wavering effect.
FEEDBACK LEVEL	-63 - +63	Determines the amount of output sound (with the flanging effect) that is returned to the input. The larger the value, the more complex and pronounced the flanging effect becomes.
LFO Wave	Triangle, Sine, Random	Determines the waveform: triangular wave, sine wave or random.

Parameter	Value	Description
Sensitivity	0 - 127	Determines the sensitivity. The higher the value the greater the change.
Threshold	0 - 127	Determines the input level at which effect begins to be applied.
Dry/Wet	D63>W - D<W63	Determines the original sound and the effect sound.

PHASER

Similar to Flanger, this produces rolling timbre changes and a pronounced up/down filter sweep effect.

Effect Type
PHASER 1
PHASER 2
EP PHASER 1
EP PHASER 2
EP PHASER 3
TEMPO PHASER
DYNA PHASER

Parameter	Value	Description
LFO Freq.	0.00 - 39.7 Hz	Determines the frequency of oscillation, or the speed of the wavering effect.
LFO Depth	0 - 127	Determines the depth of oscillation, or the amount of the wavering effect.
Phase Shift	0 - 127	Determines the phase relationship between the processed signal and the original. This changes the sound characteristics of the Phaser effect.
Feedback Level	-63 - +63	Determines the amount of output sound (with the phasing effect) that is returned to the input. The larger the value, the more complex and pronounced the phasing effect becomes.
Sensitivity	0 - 127	Determines the sensitivity. The higher the value the greater the change.
Threshold	0 - 127	Determines the input level at which effect begins to be applied.
Dry/Wet	D63>W - D<W63	Determines the balance of the original sound and the effect sound.

TREMOLO/AUTO PAN

This periodically changes the volume and has the effect of moving the sound image both front and back, and left and right.

Effect Type
TREMOLO 1
TREMOLO 2
XG TREMOLO
EP TREMOLO
GT TREMOLO 1
GT TREMOLO 2

Effect Type
ORGAN TREMOLO
AUTO PAN
XG AT PAN 1
XG AT PAN 2
EP AUTO PAN

Parameter	Value	Description
LFO Freq.	0.00 - 39.7 Hz	Determines the tremolo speed.
LFO Depth	0 - 127	Determines the depth of the Tremolo effect.
AM Depth	0 - 127	Determines the amount of volume change.
PM Depth	0 - 127	Determines the amount of pitch change in the sound.
Input Mode	Mono, Stereo	Determines the input configuration.
L/R Depth	0 - 127	Determines the depth of panning between the left and right channels.
F/R Depth	0 - 127	Front/rear. Determines the depth of the front and rear panning effect. This controls both level and pitch at the same time.
Pan	L<->R, L->R, L<-R, Lturn, Rturn, L/R	Determines the Auto Pan type. ("L<->R" is a sine wave and "L/R" is a sawtooth wave.)
Dry/Wet	D63>W - D<W63	Determines the balance of original sound and the effect sound.

ROTARY SPEAKER

This popular effect (used mainly for electronic organ sounds) recreates the rich, animated pulsing sound of a rotating speaker horn.

Effect Type	Effect Type
XG ROTARY SP	DUAL ROTSP 2
ROTARY SP 1	DIST+ROT SP
ROTARY SP 2	ODRV+ROT SP
ROTARY SP 3	AMP+ROT SP
ROTARY SP 4	DIST+2ROT SP
ROTARY SP 5	ODRV+2ROT SP
2WAY ROT SP	AMP+2ROT SP
DUAL ROTSP 1	

Parameter	Value	Description
EQ Low Freq.	32 - 2.0k Hz	Determines the central frequency of the low frequency range that is boosted or cut.
EQ Low Gain	-12 - +12 dB	Determines the amount over which the low frequency range is boosted or cut.
EQ Middle Freq.	100 - 16k Hz	Determines the central frequency of the middle frequency range that is boosted or cut.
EQ Middle Gain	-12 - +12 dB	Determines the amount over which the middle frequency range is boosted or cut.
EQ Hi.Freq.	500 - 16k Hz	Determines the central frequency of the high frequency range that is boosted or cut.
EQ Hi.Gain	-12 - +12 dB	Determines the amount over which the high frequency range is boosted or cut.
Low/High Balance	L63>H - L<H63	Determines the volume balance between low and high speakers.
MIC L-R Angle	0 - 180deg	Determines the L/R angle of the apparent microphone.
Dist. Drive	0 - 127	Determines the depth of distortion. The higher the value the greater the amount of distortion.
Amp. Type	Off, Stack, Combo, Tube	Determines the amplifier type simulated.
Drive	0 - 127	Determines the amount of distortion.

DISTORTION

This effect adds distortion to the sound.

Effect Type	Effect Type
DIST HARD 1	V_DIST HARD
DIST HARD 2	V_DIST SOFT
DIST SOFT 1	COMP+DIST
DIST SOFT 2	XG CMP+DIST
ST DIST HARD	AMP SIM
ST DIST SOFT	XG AMP SIM
OVERDRIVE	ST AMP SIM 1
ST OVERDRIVE	ST AMP SIM 2
XG DIST	XG ST AMP
XG ST DIST	

Parameter	Value	Description
Drive	0 - 127	Determines the amount or degree of distortion in the sound.
Amp. Type	Off, Stack, Combo, Tube	Determines the type of amplifier that is simulated.
LPF Cutoff	1.0 - 18kHz, Thru	Determines the cutoff frequency of the low pass filter. Frequencies above this value are cut or filtered out.
OutputLevel	0 - 127	Determines the level or volume of the processed sound.
EQ Low Gain	-12 - +12 dB	Determines the amount of EQ boost or cut in the low frequency range.
EQ Middle Gain	-12 - +12 dB	Determines the amount of EQ boost or cut in the mid frequency range.
Overdrive	0 - 100 %	Determines the depth of overdrive. The higher the value the greater the amount of distortion.
Device	Transistor, Vintage, Dist 1, Dist 2, Fuzz	Determines the device that will create distortion: Transistor, VintageTube, Distortion, Fuzz and so on.
Speaker	Flat, Stack, Combo, Twin, Radio, Megaphone	Determines the simulated speaker type: Flat, Stack, Combo, Twin, Radio, Megaphone and so on.
Presence	0 - 20	Values in the higher range can give vocals more presence.
Comp. Threshold	-48 - -6 db	Determines the input level at which compression begins to be applied.
Dry/Wet	D63>W - D<W63	Determines the balance of the original sound and the effect sound.

DISTORTION+

A combination of Distortion and Delay.

Effect Type	Effect Type
DIST+DELAY	V_DIST H+DLY
ODRV+DELAY	V_DIST S+DLY
XG DIST+DLY	DIST+T DLY
XG ODRV+DLY	ODRV+T DLY
CMP+DIST+DLY	CMP+DST+TDLY
CMP+ODRV+DLY	CMP+OD+TDLY
XG CMP+DT+DL	V_DST H+TDLY
XG CMP+OD+DL	V_DST S+TDLY

Parameter	Value	Description
Dist. Drive	0 - 127	Determines the depth of distortion. The higher the value the greater the amount of distortion.
Dist. Out Level	0 - 127	Determines the output level of the distorted sound.
L DelayTime	0.1 - 1486.0 msec	Determines the time that elapses between the original sound and the delayed repeat in the left channel.
R DelayTime	0.1 - 1486.0 msec	Determines the time that elapses between the original sound and the delayed repeat in the right channel.
Delay Feedback	-63 - +63	Determines the amount of delayed repeats in the sound.
Comp. Threshold	-48 - -6db	Determines the input level at which compression begins to be applied.
DelayTime	0.1 - 1486.0 msec	Determines the time that elapses between the original sound and the delayed repeat.
Overdrive	0 - 100 %	Determines the depth of overdrive. The higher the value the greater the amount of distortion.
Device	Transistor, Vintage, Dist 1, Dist 2, Fuzz	Determines the device that will create distortion: Transistor, VintageTube, Distortion, Fuzz and so on.
Speaker	Flat, Stack, Combo, Twin, Radio, Megaphone	Determines the simulated speaker type: Flat, Stack, Combo, Twin, Radio, Megaphone and so on.
Presence	0 - 20	Values in the higher range can give vocals more presence.
Dry/Wet	D63>W - D<W63	Determines the balance of original sound and the effect sound.

WAH

This uses an automatic up/down filter sweep to change the timbre of the sound, producing a “wahwah” sound.

Effect Type	Effect Type
AUTO WAH	TC WAH+ODRV
XG AUTO WAH	XG TC WAH+OD
TOUCH WAH 1	CLAVI TC WAH
TOUCH WAH 2	EP TOUCH WAH
AT WAH+DIST	WAH+DST+TDLY
XG AT WH+DST	WAH+OD+T DLY
AT WAH+ODRV	WAH+DIST+DLY
XG AT WAH+OD	XG WH+DST+DL
TC WAH+DIST	WAH+ODRV+DLY
XG TC WH+DST	XG WH+OD+DLY

Parameter	Value	Description
LFO Freq.	0.00 - 39.7 Hz	Determines the speed of the Wah effect.
LFO Depth	0 - 127	Determines the depth of the Wah effect.
Cutoff	0 - 127	Determines the central frequency that the wah filter acts upon.
Resonance	1.0 - 12.0	Determines the frequency bandwidth (around the central frequency set in Cutoff above) that the wah filter affects.
Drive	0 - 127	Higher values result in a more distorted sound.
Sensitivity	0 - 127	Determines the degree to which the wah filter is affected by your playing touch.
DelayTime	0.1 - 1486.0 msec	Determines the time that elapses between the original sound and the delayed repeat.
Delay Feedback	-63 - +63	Determines the amount of delayed repeats in the sound.
Comp. Threshold	-48 - -6db	Determines the input level at which compression begins to be applied.
Dist. Out Level	0 - 127	Determines the output level of the distorted sound.
Dry/Wet	D63>W - D<W63	Determines the balance of the original sound and the effect sound.

DYNAMIC

This effect (also called compression) “squeezes” the overall dynamic range of the sound, and has a gain control—letting you make soft sounds louder, and thus give more “punch” to the sound.

Effect Type
M BAND COMP
COMPRESSOR
NOISE GATE

Parameter	Value	Description
Type	Normal, Low, Mid, High, Low/High, Low/Mid, Mid/High, FullBit, Wild, Attack, LowEnd, Hard, Basic	Determines the compressor type.
EQ Low Gain	-63 - +63	Determines the amount of low-frequency gain (boost or cut).
EQ Middle Gain	-63 - +63	Determines the amount of mid-frequency gain (boost or cut).
EQ Hi.Gain	-63 - +63	Determines the amount of high-frequency gain (boost or cut).
Attack	1 - 40 msec	Determines how soon the compression effect is applied, once the compressor has been triggered (as a result of Threshold below).
Release	10 - 680 msec	Determines how soon the compressor returns to its normal gain, once the trigger signal drops below the Threshold point.
Threshold	multi-band compressor: -32 - +32 compressor: -48 - -6 dB Noise Gate: -72 - -30 dB	Determines the level of the input signal required to trigger the compressor. Signals at a level below the Threshold pass through unaffected; signals at and above the Threshold are compressed.
Ratio	1.0 - 20.0	Determines the amount of compression of the sound (for signals passing the Threshold). This is expressed as a ratio—the change in output signal relative to the change in input. The range here is 1/1 (no change in output signal, hence no compression) to 20/1. Higher ratios result in greater compression.
OutputLevel	0 - 127	Determines the overall output of the compressed signal. Use this to bring up the overall level after you've reduced the dynamic range with compression.

EQ/ENHANCER

This effect boosts or cuts specific frequency bands, allowing you to shape the tone of the sound as required by the mix.

Effect Type
ST 2BAND EQ
ST 3BAND EQ
XG 3BAND EQ
EQ DISCO
EQ TEL
HM ENHANCER
XG HM ENHNCE

Parameter	Value	Description
EQ LowFreq.	50 - 2.0k Hz ST2BandEQ: 32 - 2.0k Hz	Determines the central frequency of the low frequency range that is to be boosted or cut.
EQ Low Gain	-12 - +12 dB	Determines the amount over which the low frequency range is boosted or cut.
EQ Middle Freq.	100 - 16k Hz	Determines the central frequency of the middle frequency range that is to be boosted or cut.
EQ Middle Gain	-12 - +12 dB	Determines the amount over which the middle frequency range is boosted or cut.
EQ M Width	0.1 - 12.0	Determines the bandwidth or the range of frequencies around the specific middle frequency that is to be boosted or cut. Lower values let you narrow in on a specific frequency, while higher values select a broader range of frequencies to be affected.
EQ Hi.Freq.	500Hz - 16 kHz	Determines the central frequency of the high frequency range that is to be boosted or cut.
EQ Hi.Gain	-12 - +12 dB	Determines how much increase/ decrease the wave frequency point of EQ high frequency.
HPF Cutoff	500Hz - 16 k Hz	Determines the cutoff frequency of the low pass filter. Frequencies above this value are cut or filtered out.
Drive	0 - 127	Determines the amount or depth of the Enhancer effect.
Mix Level	0 - 127	Determines how much of the processed enhanced sound is mixed together with the original sound.

PITCH CHANGE

This effect changes the pitch.

Effect Type
PITCH CHANGE
XG PCH CHG 1
XG PCH CHG 2

Parameter	Value	Description
Pitch	-24 - +24	Determines the amount of pitch change in semitones.
Pitch Fine 1	-50 - +50	Fine pitch adjustment to detune the sound and create a chorus effect.
Pitch Fine 2	-50 - +50	Fine pitch adjustment to detune the sound and create a chorus effect.
Initial Delay	0.1 - 400 msec	Determines the time that elapses between the original sound and the early reflections.
Feedback Level	-63 - +63	Determines the amount of delayed repeats in the sound. When this is set to 0%, the delayed repeat from the second time will not sound.
Dry/Wet	D63>W - D<W63	Determines the balance of original sound and the effect sound.

MISCELLANEOUS

Creates special effects.

Effect Type
AMBIENCE
IMPULSE EXP
RESONATOR
VOICE CANCEL
TALKING MOD
LO-FI
DYNA FILTER
DYNA RINGMOD
RING MOD
ISOLATOR

AMBIENCE

Parameter	Value	Description
DelayTime	0.0 - 50.0 msec	Determines the delay time.
Output Phase	Normal, Invers	Determines the phase of the effect sound.
Dry/Wet	D63>W - D<W63	Determines the balance of original sound and the effect sound.

IMPULSE EXP

Parameter	Value	Description
Density	0.159 - 22.61 msec	Determines the density.
Dispersion	4.028 msec - 4.000 sec	Determines the resonance time.
Wet Level	0 - 127	Determines the level of the effected sound.

RESONATOR

Parameter	Value	Description
Type	Type1 - 6	Determines the type.
Decay Time	4.028 msec - 4.000 sec	Determines the length of reverberation.
LPF Cutoff	28.5Hz - 21.6 kHz (Thru)	Determines the cutoff frequency of the Low Pass Filter. The portion of the signal above the specified frequency is cut.
Dispersion	0 - 16	Determines the resonance time.
Wet Level	0 - 127	Determines the level of the effected sound.

VOICE CANCEL

Parameter	Value	Description
Low Adjust	0 - 26	Determines the frequencies in the lower portion of the middle range that are attenuated.
High Adjust	0 - 26	Determines the frequencies in the upper portion of the middle range that are attenuated.

TALKING MOD

Parameter	Value	Description
Vowel	a, i, u, e, o	Determines the specific vowel used for the "talking" effect.
Drive	0 - 127	Determines the effect depth.
OutputLevel	0 - 127	Determines the output level of the effect-processed sound.

LO-FI

Parameter	Value	Description
Sampling Control	44.1 kHz - 345.0 Hz	Determines the sampling frequency.
Word Length	0 - 127	Determines the resolution or roughness of the sound.
Filter Type	Thru, PwrBass, Radio, Tel, Clean, Low	Determines the filter type.
Dry/Wet	D63>W - D<W63	Determines the balance of original sound and the effect sound.

DYNA FILTER

Parameter	Value	Description
Sensitivity	0 - 127	Determines the sensitivity. The higher the value the greater the change.

Parameter	Value	Description
Level Offset	0 - 127	Determines the offset values of the filter frequency. The offset value affects the filter frequency when no control signals are received.
Filter Type	LPF (12 dB), LPF (18 dB), LPF (24 dB), HPF, BPF, BEF	Determines the filter type.
Resonance	-16 - +111	The higher the value, the more sharp the frequency response curve is.
Dry/Wet	D63>W - D<W63	Determines the balance of original sound and the effect sound.

DYNA RINGMOD

Parameter	Value	Description
Sensitivity	0 - 127	Determines the modulation sensitivity for the input change.
Threshold	0 - 127	Determines the input level at which effect begins to be applied.
Dry/Wet	D63>W - D<W63	Determines the balance of original sound and the effect sound.

RING MOD

Parameter	Value	Description
Frequency	0.7 - 5002.6 Hz	Determines the frequency for the Amplitude Modulation.
Frequency Fine	0 - 127	Determines detailed adjustment of the Amplitude Modulation.
LFO Wave	Triangle, Sine	Selects a triangular wave or sine wave as the wave for modulation.
LFO Depth	0 - 127	Determines the wave depth. The higher the value, the greater the effect.
Dry/Wet	D63>W - D<W63	Determines the balance of original sound and the effect sound.

ISOLATOR

Parameter	Value	Description
On/Off	Off, On	Determines the on/off status for the effect.
Low Mute	Off, On	Mute switch for the low frequency range.
Middle Mute	Off, On	Mute switch for the mid frequency range.
High Mute	Off, On	Mute switch for the high frequency range.
Low Level	0 - 127	Determines the level of the low frequencies.
Middle Level	0 - 127	Determines the level of the mid frequencies.
High Level	0 - 127	Determines the level of the high frequencies.

THRU

Bypass control. This cancels the effect processing.

Effect Type
Thru

This DDK-7 features 274 different real rhythms featuring actual drum and percussion sampled sounds. Automatic Accompaniment functions are used with the rhythms, providing appropriate and completely automatic accompaniment to match the style of the selected rhythm. Moreover, the DDK-7 has a Keyboard Percussion feature that allows you to play drum and percussion sounds from the Upper, Lower keyboard and Pedalboard.

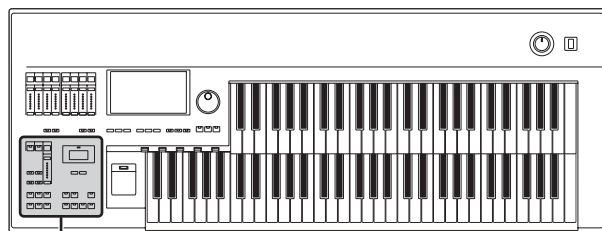

Rhythm/Keyboard Percussion

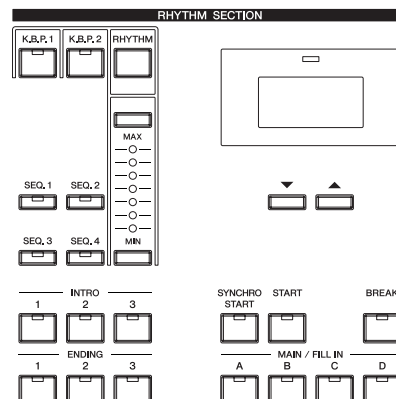

Contents

<p>1 Selecting rhythms with the Rhythm button60</p> <ul style="list-style-type: none"> • Selecting a rhythm60 • Operating the rhythm from the panel63 • Changing the rhythm volume65 • Adjusting the tempo66 • Changing the rhythm reverb.67 <p>2 Rhythm List68</p> <p>3 Accompaniment70</p> <p>4 Automatic Accompaniment – Auto Bass Chord (A.B.C.)71</p>	<p>5 Melody On Chord (M.O.C.)73</p> <p>6 Keyboard Percussion74</p> <ul style="list-style-type: none"> • Using the Preset Keyboard Percussion74 • Preset Keyboard Percussion List76 • Assigning sounds to the User Keyboard Percussion79 • Copying the Keyboard Percussion settings81 • Detailed settings for each percussion instrument83 • Kit Assign List85
---	---

1 Selecting rhythms with the Rhythm button

A total of 274 rhythms can be instantly selected from the Rhythm Menu Display which is called up by pressing the RHYTHM button.

Selecting a rhythm

In the explanation below, 16Beat 1 in the POPS category is selected as an example.

- 1 Press the Rhythm button in the RHYTHM section on the front panel.**

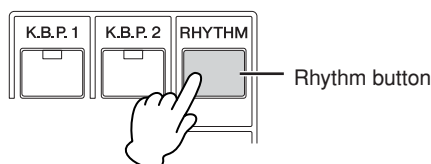

The Rhythm Menu is displayed.

2 Select the desired Rhythm category with the category buttons in the display.

You can also choose the “User” category to select a User rhythm you have created in the Rhythm Pattern Program.

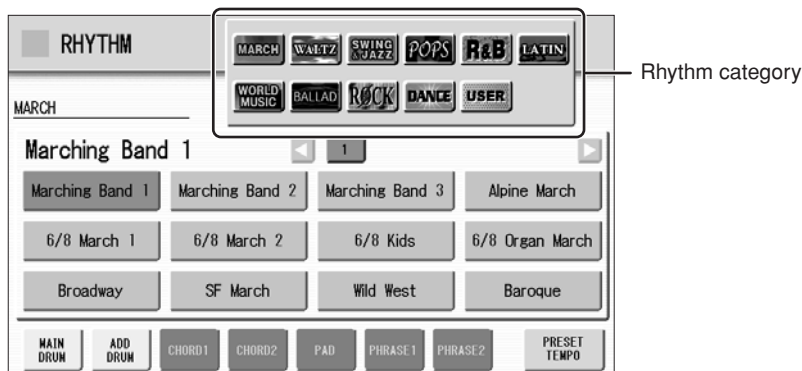

For example, to call up 16Beat 1, select the POPS category.

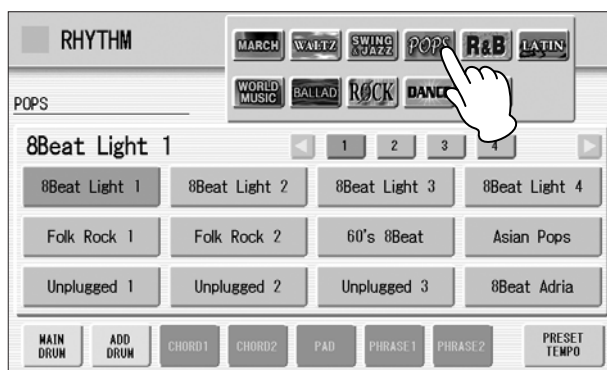

The name of the selected category (Pops) is displayed on the upper left. The Rhythm name shown under the category name is that of the currently assigned Rhythm and is irrelevant to the Rhythm menu below.

3 Select the desired rhythm name from the Rhythm menu.

The Rhythm menu contains many Pops rhythms, more than can fit on the display page. To change the display pages, press the appropriate number buttons in the display.

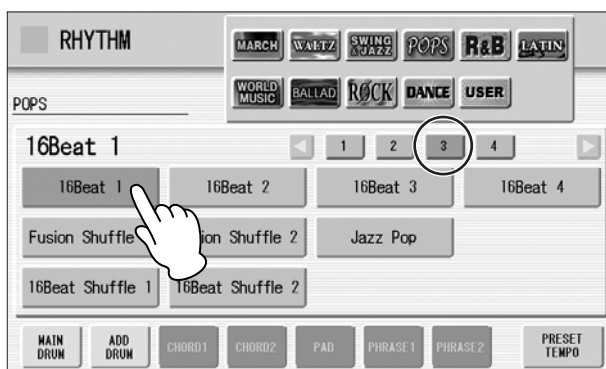

The color of the selected rhythm name changes to orange, indicating that it has been selected.



Reference Page

Rhythm Pattern Program
(page 148)

Rhythm Structure

Each rhythm is made up of “sections.” Since each section is a rhythmic variation of the basic rhythm, you can use them to add “spice” to your performance and mix up the beats while you are playing. You can freely change the section while the rhythm is played back.

INTRO

This is used for the beginning of the song. There are three Intro sections that can be selected with INTRO [1] – [3] buttons. When the Intro finishes playing, the rhythm automatically shifts to the Main section.

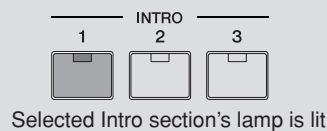

MAIN

This is used for playing the main part of the song. There are four Main sections that can be selected with MAIN/FILL IN [A] – [D] buttons. The rhythm pattern of several measures repeats indefinitely.

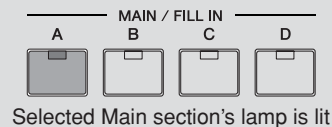

FILL IN

This is designed for use as a temporary and regular rhythmic pattern to spice up a repeating rhythm. There are four Fill In sections that can be played by pressing the selected (lit) MAIN/FILL IN [A] – [D] buttons as desired. When one measure pattern of Fill In finishes playing, the rhythm is automatically shifts to the Main section.

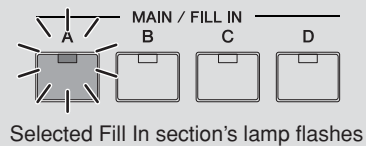

BREAK

This lets you add dynamic variations and breaks in the rhythm pattern. The Break section is selected by pressing the [BREAK] button. When the one-measure Break pattern finishes playing, the rhythm automatically shifts to the Main section.



The lamp is lit when the Break section is selected

ENDING

This is used for the ending of the song. There are three Ending sections that can be selected with the ENDING [1] – [3] buttons. When the ending is finished, the rhythm automatically stops.

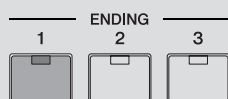

Selected Ending section's lamp is lit

Operating the rhythm from the panel

You can turn the rhythm on/off and switch the sections as desired by pressing the buttons on the panel. Using the Fill Ins and Break patterns let you add dynamic interest and “spice” to your performance.

To start/stop the rhythm:

START

The rhythm begins as soon as the [START] button is pressed. To stop the rhythm, press the button again.

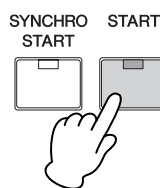

SYNCHRO START

The [SYNCHRO START] button puts the rhythm in “standby.” The rhythm starts when you press a note on the Lower keyboard or Pedalboard.

When you start the rhythm with the [SYNCHRO START] button, pressing this button again stops the rhythm.

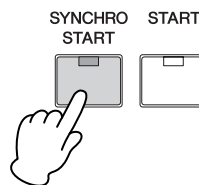

INTRO

Pressing one of the INTRO [1] – [3] buttons automatically adds a short introduction before starting the actual (Main) rhythm. First press one of the INTRO [1] – [3] buttons, then press the [START] or [SYNCHRO START] button to actually start the rhythm.

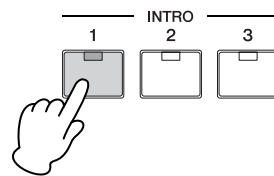

While the introduction is playing, the BAR/BEAT display shows the countdown to the first measure of the pattern. For example, if there is a four-measure lead-in for a pattern in 4/4 time, the display at right appears:

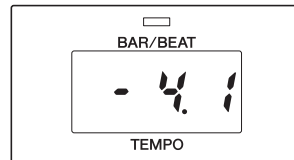

NOTE

When an Intro or Ending pattern is playing, the Lower Keyboard cannot be played.

ENDING

Pressing one of the ENDING [1] – [3] buttons automatically adds an ending phrase before stopping the rhythm.

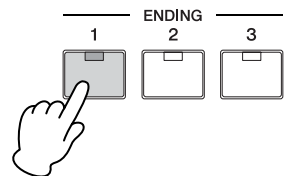

When you press the Ending button while rhythm is playing back, the rhythm will automatically stop after the ending phrase is played. You can have the ending gradually slow down (*ritardando*) by pressing the ENDING button once again, while the ending is playing.

NOTE

Pressing the ENDING [1] button during playback of the Main section will first call up the fill in pattern, then the Ending 1 pattern.

To switch the rhythm sections:

You can change the rhythm section of the Main phrase by pressing the desired MAIN/FILL IN [A] – [D] button. The selected section's lamp (above the button) is lit.

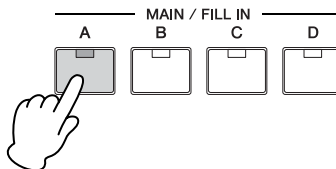

To use the Fill In patterns:

As you play the DDK-7 along with the rhythm, occasionally press the selected MAIN/FILL button as desired. The Fill In pattern (one measure) will be played and the selected Fill In section's lamp (above the button) flashes.

When you use the Auto Fill In function, Fill Ins will be played automatically. The Auto Fill In function is set in the Rhythm Condition display.

Pressing the Rhythm button on the panel again (or pressing the rhythm name of the selected rhythm in the display again) calls up the Rhythm Condition Display.

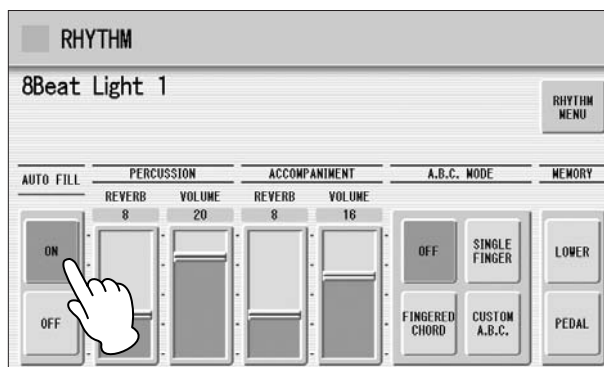

When Auto Fill is set to ON in the left side of the display, the Fill In pattern is automatically played whenever you switch the Main sections.

To use the Break patterns:

As you play the DDK-7 along with the rhythm, occasionally press the [BREAK] button.

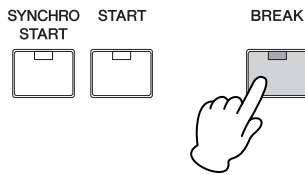

Moreover, you can start/stop the rhythm and switch the sections by using the Footswitch or optional footpedal. See page 194 for details.

Changing the rhythm volume

There are two ways to set the rhythm volume: using the VOLUME buttons on the panel and using the volume slider in the display. The volume buttons let you make coarse adjustments to the volume while the slider gives you fine control.

Using VOLUME buttons on the panel

(coarse):

Press the VOLUME buttons of the rhythm on the panel to set the desired level. The buttons have seven volume settings, from a minimum of 0, or no sound, to a maximum of full volume.

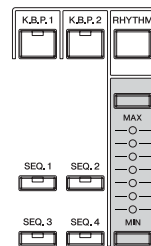

Using VOLUME slider in the display (fine):

Pressing the rhythm button on the panel again (or pressing the rhythm name of the selected rhythm in the display again) calls up the Rhythm Condition Display.

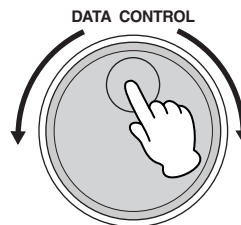
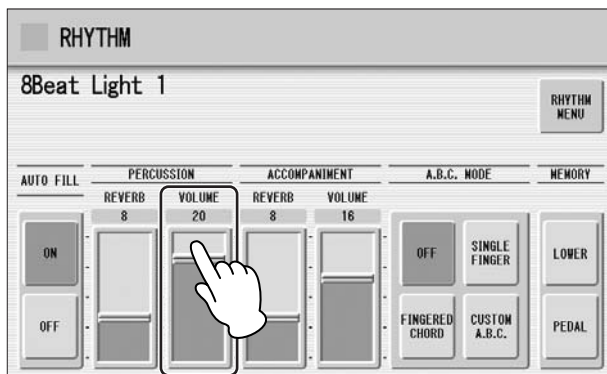

To set the volume, touch the PERCUSSION VOLUME slider in the display or use the Data Control Dial. The control range is from 0 (no sound) to 24 (full volume).



NOTE

Depending on the volume value (set by the slider), two adjacent VOLUME lamps may be lit at the same time, indicating an intermediate position.

Adjusting the tempo

You can adjust the rhythm tempo by pressing the TEMPO buttons. Pressing the right button increases the tempo and pressing the left button decreases it. Each rhythm has its original (preset) tempo. Press the TEMPO buttons simultaneously to restore the tempo to the original setting.

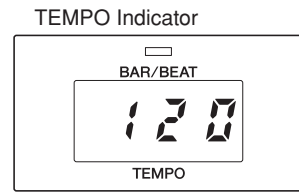

TEMPO display shows the current tempo. Displayed values are given in beats per minute.

The tempo range is 40 to 240 beats per minute.

Each rhythm has its original (preset) tempo. Press [PRESET TEMPO] button in the display to restore the tempo to the original setting.



When the rhythm begins playing, the TEMPO indicator changes function to a BAR/BEAT indicator.

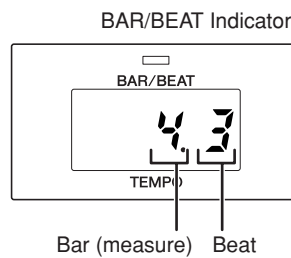

On the BAR/BEAT indicator, the number on the left indicates the current bar or measure and the one on the right indicates the number of the beat in each bar.

You can also see the Tempo and Bar/Beat indications in the Voice Display. In the Voice Display, both Tempo and Bar/Beat can be seen in one display.

 **Reference Page**
Voice Display (page 18)

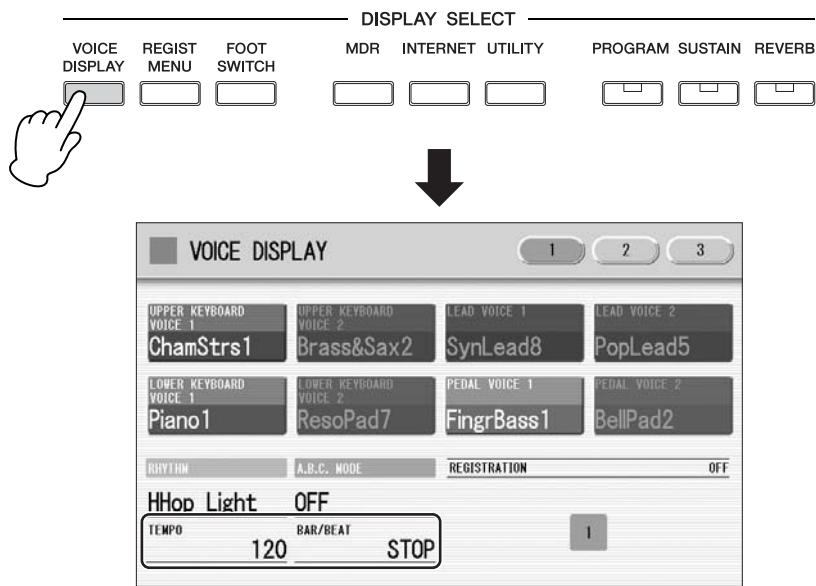

Changing the rhythm reverb

You can adjust the amount of reverb applied to the rhythms and the percussion sounds used in the rhythms in the Rhythm Condition display.

 **Reference Page**
Reverb (page 46)

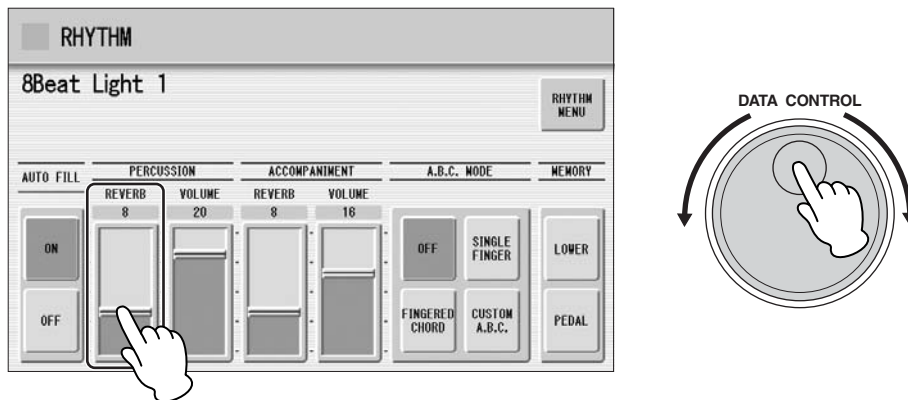

When the Reverb depth for the entire instrument in Reverb Display Page 1 is set to the minimum, the setting here will have no effect.

Range: 0 – 24

2 Rhythm List

This list shows all available rhythms on the DDK-7. Numbers written at the left side of each column in this list indicate the numbered buttons displayed in the Rhythm Menu.

MARCH							
1	Marching Band 1	2	Fast Jazz	2	British 16Beat	1	Bossa Nova 1
	Marching Band 2		Combo Swing		16Beat 1		Bossa Nova 2
	Marching Band 3		Cool Combo		16Beat 2		Bossa Nova 3
	Alpine March		Light Swing		16Beat 3		Pop Bossa
	6/8 March 1		Afro Cuban 1	16Beat 4	2	Mambo 1	
	6/8 March 2		Afro Cuban 2	3		Mambo 2	
	6/8 Kids		Bebop			Fusion Shuffle 1	Salsa 1
	6/8 Organ March		Five-Four	Fusion Shuffle 2		Salsa 2	
	Broadway	3	Jazz Ballad 1	Jazz Pop		Montuno	
	SF March		Jazz Ballad 2	16Beat Shuffle 1	Calypso		
	Wild West		Movie Swing	16Beat Shuffle 2	Cha Cha Cha		
	Baroque		Piano Trio	Pop Shuffle	Big Band Cha Cha		
	WALTZ		Midnight Swing	Eurovision Pop	Pop Cha Cha		
	1		Vienna Waltz	Slow Jazz	British Pop	3	Rumba
			Orchestra Waltz	Moonlight 1	4		Sing Along
Simple Waltz			Moonlight 2	Simple Shuffle 1			Fast Rumba
Gentle Waltz		Winter Song 1	Simple Shuffle 2	Guitar Rumba			
Guitar Serenade		Winter Song 2	Simple Shuffle 3	Beguine 1			
Snow Waltz		4	R&B		Beguine 2		
Classic Waltz			Foxtrot	Blues Rock	Cuban Bolero		
Mariachi			Slowfox	Motor City	Tango 1		
Alpine Waltz			Quickstep	Soul 1	Tango 2		
Musette			Dixieland 1	Soul 2	Tango Orchestra		
Jazz Waltz 1			Dixieland 2	16Beat Soul	Tango Milonga		
Jazz Waltz 2			Dixieland Jazz	Frankly Soul	WORLD MUSIC		
Jazz Waltz 3			Ragtime	Gospel Funk	Bolero		
Jazz Waltz 4	Charleston	Jazz Funk	Flamenco				
Modern Waltz	Guitar Swing	Funk Beat 1	Pop Flamenco				
Pop Waltz	POPS		Pasodoble				
Country Waltz	8Beat Light 1	Funk Beat 2	Polka 1				
SWING&JAZZ		8Beat Light 2	Detroit Pop 1	1	Polka 2		
1	Big Band 1	8Beat Light 3	Detroit Pop 2		Banda Polka		
	Big Band 2	8Beat Light 4	New R&B	Irish Dance			
	Big Band 3	Folk Rock 1	Modern R&B	Tarantella			
	Big Band 4	Folk Rock 2	New Gospel	Sirtaki			
	Big Band 5	60's 8Beat	Cool Blues	Enka			
	Big Band 6	Asian Pops	Gospel Shuffle	2	Reggae		
	Big Band 7	Unplugged 1	Gospel Sisters		Happy Reggae		
	Big Band Bop	Unplugged 2	Amazing Gospel		Sheriff Reggae		
	Orch. Big Band	Unplugged 3	6/8 Blues		Shuffle Reggae		
	Orchestra Swing	8Beat Adria	Slow Blues		Bluegrass 1		
	Movie Panther	Bubblegum Pop	6/8 Soul	Bluegrass 2			
	Jungle Drum	70's 8Beat	Blues Shuffle	Hoedown			
	Jazz Club	Tijuana	LATIN		Country 2/4		
	Simple Swing	SingerSongWriter	1	Samba	Country Shuffle		
	Acoustic Jazz	Surfin' 8Beat		Big Band Samba	Country Band		
Medium Jazz	Finger Pickin'	Light Samba 1		Hawaiian			
	Heart Beat	Light Samba 2		Mexican Dance			
	Guitar Pop	Pop Samba 1					
		Pop Samba 2					

BALLAD		DANCE			
1	Power Ballad	1	Ibiza 1		
	Dramatic Ballad		Ibiza 2		
	Movie Ballad 1		Euro Trance		
	Movie Ballad 2		Disco Teens		
	Secret Service		Techno Party		
	Carpenters Pop		Club Dance		
	Romantic Ballad		Dream Dance		
	Love Song		Club House		
	16Beat Ballad 1		UK Pop		
	16Beat Ballad 2		US Disco		
	16Beat Ballad 3		Swing House		
	Easy Ballad		US Pop		
	2		Guitar Ballad 1	2	US Hip Hop
			Guitar Ballad 2		Classic Hip Hop
Guitar Ballad 3		Trip Hop			
Organ Ballad		Chart Pop			
Chart Ballad		Ground Beat			
Analog Ballad		Hip Hop Groove			
Pop Ballad		Hip Hop Pop			
8Beat Modern		Hip Hop Light			
Chillout		Euro Hip Hop			
Slow&Easy		Latin DJ's			
3		6/8 Slow Rock 1	3		Club Latin
		6/8 Slow Rock 2			Latin Disco 1
		6/8 Orchestra 1			Latin Disco 2
		6/8 Orchestra 2			Garage
	6/8 Ballad	6/8 Trance			
	Acoustic Ballad	80's Dance			
ROCK	1	4	Pop Beat 1		
			Pop Beat 2		
			Southern Rock	Funky Dance	
			60's Rock 1	Disco Philly 1	
			60's Rock 2	Disco Philly 2	
			Hard Rock 1	70's Disco 1	
			Hard Rock 2	70's Disco 2	
			Rock Shuffle 1	Disco Funk	
			Rock Shuffle 2	Disco Chocolate	
			Tears Rock 1	Dance Pop	
			Tears Rock 2		
			Soft Rock		
			British Rock		
			2	Country Rock 1	
	Country Rock 2				
	New Country				
	Cowboy Rock				
	Rock&Roll 1				
	Rock&Roll 2				
	Skiffle				
	Caribbean Rock				
	R&R Shuffle				
	Jive				
	Boogie Woogie				

Certain rhythms created for use with slow, soft Songs or for Songs that do not use a bass part at the beginning, may not have drum sections. To use these rhythms, refer to the following information.

Some sections of the following nine rhythms are configured with accompaniment only; they do not contain any drum or percussion.

Category	Rhythm	Section
MARCH	6/8 Organ March	Main A, Main B
	Baroque	All sections except Intro 1
WALTZ	Simple Waltz	Ending 1
	Guitar Serenade	All sections except Intro 1
WORLD MUSIC	Banda Polka	Main A, Fill In A
	Hoedown	Ending 1
	Mexican Dance	Main A, Fill In A
BALLAD	Dramatic Ballad	Main A
ROCK	R&R Shuffle	Ending 1

Some sections of the following five rhythms do not contain an Auto Bass part. This means that even though the Auto Bass Chord is turned on, the bass part will not sound.

- Guitar Serenade in the WALTZ category
- Folk Rock 1 in the POPS category
- Unplugged 1 in the POPS category
- Pop Flamenco in WORLD MUSIC category
- New Country in the ROCK category

3 Accompaniment

The Accompaniment function provides arpeggiated chords and other instrumental embellishments when rhythms are used.

Accompaniment controls are selected from the Rhythm Menu and Rhythm Condition display.

1 Select the desired rhythm name in the display.

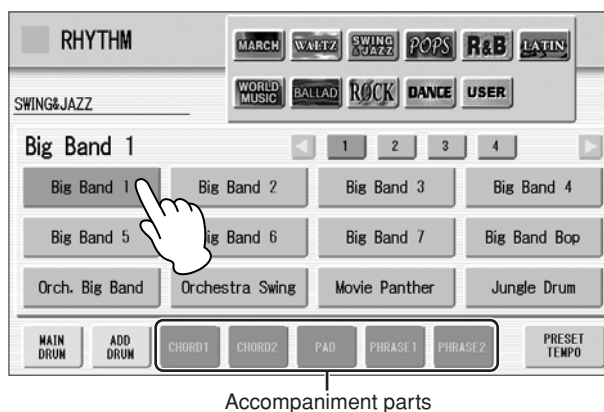

Accompaniment parts

At the bottom of the display, there are seven part buttons, such as Chord 1, Chord 2, Pad, and so on. These parts, with the exception of Main Drum and Add Drum, are Accompaniment parts.

2 Turn the desired parts on.

The Accompaniment consists of five parts, Chord 1, Chord 2, Pad, Phrase 1, and Phrase 2, and each of them can be set to on or off by pressing corresponding button in the display.

If you turn all the parts off, the Accompaniment does not sound.

CHORD 1/CHORD 2:

These are the rhythmic chord backing parts.

PAD:

This part features sustained chords and commonly uses lush sounds such as strings and organ.

PHRASE 1/PHRASE 2:

These parts are used for various embellishments and riffs that enhance the song, such as brass section accents and chord arpeggios.

Not all parts contain accompaniment data. Some parts may be empty depending on the selected rhythm and rhythm section.

Main Drum and Add Drum contains the drum and percussion rhythm patterns. When you turn both Main Drum and Add Drum off, the drum and percussion do not sound. Generally, Main Drum contains the main part of the rhythm and Add drum has additional percussion sounds, such as tambourine.

3 Adjust the volume and amount of reverb applied to the Accompaniment.

Pressing the rhythm button on the panel again calls up the Rhythm Condition display.

The two sliders at the right side of the display can control the Accompaniment volume and reverb. Touch the slider in the display or use the Data Control dial to adjust the volume/reverb.

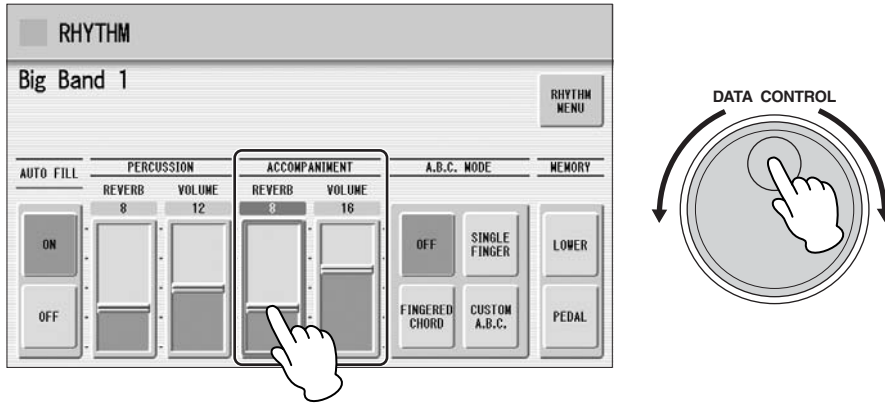

4 Automatic Accompaniment – Auto Bass Chord (A.B.C.)

The Auto Bass Chord (A.B.C.) function works with the Rhythm section of the DDK-7 to automatically produce bass accompaniment as you play. It adds an entirely new dimension to your performance by effectively putting a full backing band at your disposal. There are three modes used for producing Automatic Accompaniment patterns.

Before using the A.B.C. function, turn Pedal Poly off. If Pedal Poly is set to on, the bass pattern of the A.B.C. will not sound.



Reference Page

POLY (page 42)

To set the A.B.C. function:

Rhythm Condition Display

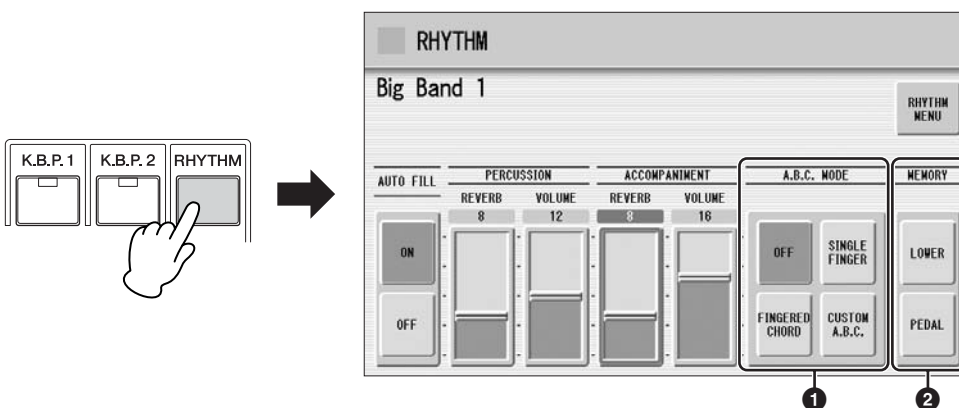

Select the A.B.C. modes in the Rhythm Condition Display.

1 A.B.C. MODE

OFF:

Cancels the Auto Bass Chord function.

SINGLE FINGER:

The Single Finger mode provides the fastest and easiest means to obtain many different chord/bass combinations. You can produce major, minor, 7th, and minor 7th chords by simply using one, or at most, two or three fingers to play the chords. The chord produced will sound in the same octave regardless of where it is played on the Lower keyboard.

C Key of C



Major chords:

Press the root of the chord (the note that corresponds to the chord's name).



Minor chords:

Simultaneously press the root and any one black key to the left of it.



7th chords:

Simultaneously press the root and any one white key to the left of it.



Minor 7th chords:

Simultaneously press the root as well as any black key and any white key to the left of it.

Playing single finger chords without the use of the rhythm lets you add full continuous chords to your performance.

FINGERED CHORD:

The Fingered Chord mode automatically produces bass accompaniment for chords played in the Lower keyboard. It allows you to use a wider range of chord types than in the Single Finger mode. In the Fingered Chord mode, you play full chords while the Auto Bass Chord function automatically selects the appropriate bass pattern. If you play only one or two notes in the Lower keyboard, the appropriate chord will sound on the basis of the previously played chord.

Key of C

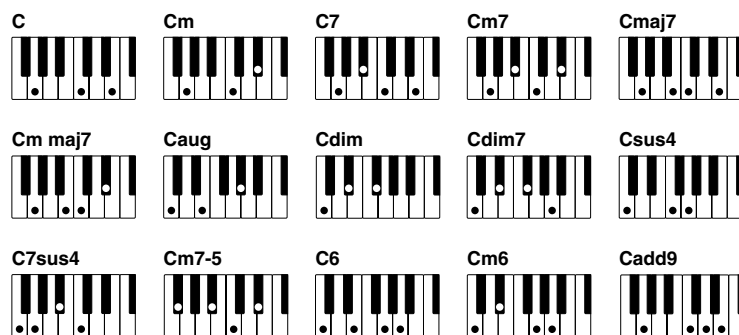

NOTE

When playing certain chords (aug, dim7, sus4, 6, and m6), make sure to play the root of the chord as the lowest note in that chord.

Playing fingered chords without the use of the rhythm lets you add full continuous chords to your performance.

CUSTOM A.B.C.:

The Custom A.B.C. mode is a slight variation on the Fingered Chord mode. It allows you to determine what bass notes will be played in the accompaniment by playing a note on the Pedalboard along with the chords you play in the Lower keyboard.

2 MEMORY

LOWER:

When this is set to on, the Lower keyboard Voices and chord accompaniment keep playing even after you release your fingers from the Lower keyboard, while the rhythm plays.

PEDAL:

When this is set to on, the Pedalboard Voices and bass accompaniment keep playing even after you release your foot from the Pedalboard, while the rhythm plays.

(In the Single Finger and Fingered modes:) When this is set to on, the bass accompaniment of the Pedalboard Voices keeps playing even after you release your fingers from the Lower keyboard.

When you start the rhythm with [SYNCHRO START] button, set the Lower/Pedal Memory to on. When Memory is off, releasing your fingers from Lower keyboard stops the rhythm.

5 Melody On Chord (M.O.C.)

The Melody On Chord (M.O.C.) feature automatically adds a harmony part to the melodies you play on the Upper keyboard. The harmony is derived from the chords you play on the Lower keyboard – or from the chords that are played for you, if you use Automatic Accompaniment. Melody On Chord has three different modes, each providing a different set of harmonics to accompany the melody played. Melody On Chord can also be controlled with the Footpedal.

To set the M.O.C. function:

Press the [VOICE DISPLAY] button, then call up the Page 3 by using the Page buttons.

Voice Display [Page 3]

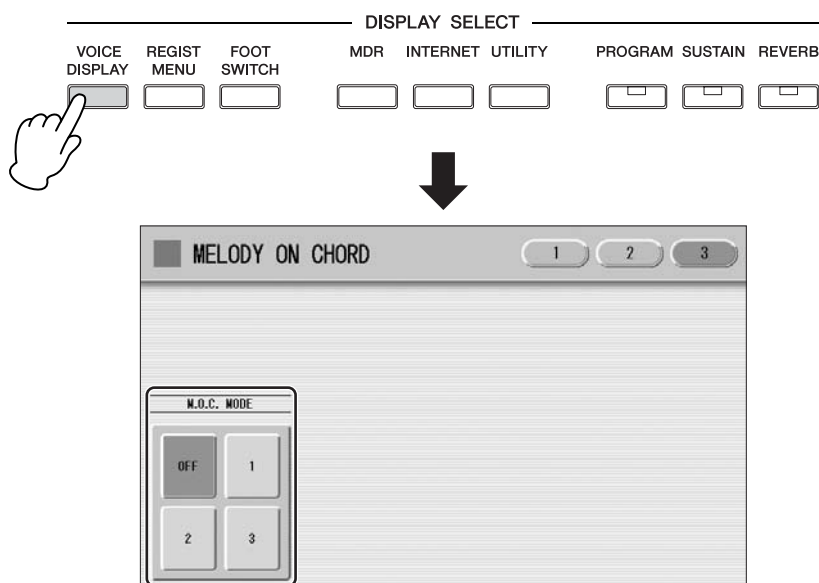

The Melody On Chord display appears.

1 M.O.C. MODE

OFF:

Cancels the Melody On Chord function.

Mode 1:

Produces harmonies of up to two notes in a range close to the melody played.

Mode 2:

Produces harmonies of up to three notes in a range close to the melody played.

Mode 3:

Produces harmonies of up to four notes in a range relatively distant from the melody played.



Reference Page

Controlling Melody On Chord (with Footpedal); (page 200)

Melody On Chord can be heard only when the Upper Keyboard Voice section's volume is set to the appropriate value. Melody On Chord does not apply to the Lead Voices.

6 Keyboard Percussion

The Keyboard Percussion function features many types of drum and percussion sounds, playable from the keyboards and Pedalboard.

Keyboard Percussion has two different modes, Preset and User. Preset Keyboard Percussion lets you play the preset drum kit sounds from the keyboards (assigned beforehand to the keys), while the User Keyboard Percussion lets you freely assign the drum sounds to any key or pedal you wish.

Using the Preset Keyboard Percussion

- 1 Turn off the Upper, Lower and/or Pedal Voices by setting each Voice's volume to MIN.
- 2 Turn on the Keyboard Percussion function by pressing the [K.B.P.1] or [K.B.P.2] button.
The Keyboard Percussion (K.B.P.) Display appears.



NOTE

In the Voice Display, each Voice section can be muted (page 19).



NOTE

Two Keyboard Percussion sets, [K.B.P.1] and [K.B.P.2], can be played at the same time by setting both buttons to on.



Reference Page

Connecting a Pedal Unit (page 229)

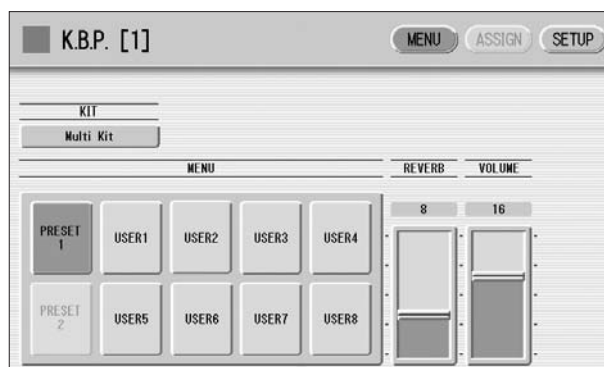
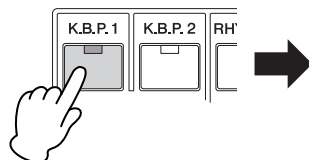

Pressing the [K.B.P.1] button calls up the Preset 1 kit on the Upper/Lower keyboards, and pressing [K.B.P.2] button calls up the Preset 2 kit on the Pedalboard.

3 Select the desired percussion kit.

As a default, Multi Kit is assigned to the keyboards but you can change the kit from a total of 16 different kits. Pressing the Kit button on the display calls up the Percussion Kit List. Choose the desired Kit within the list.

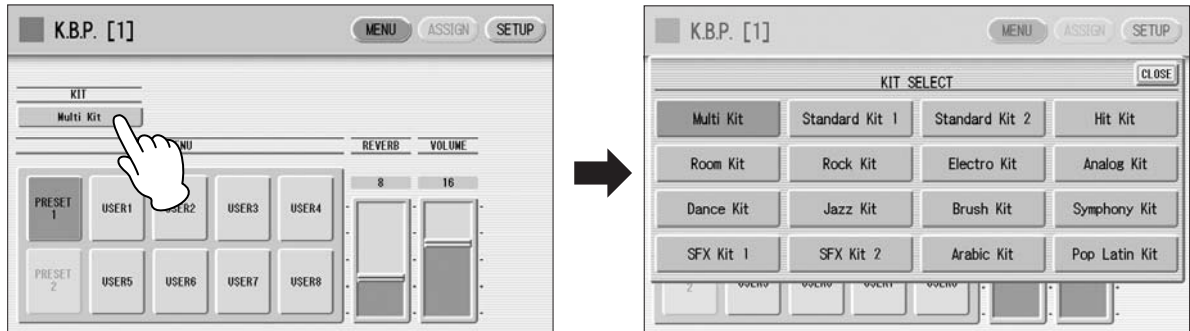

For details of percussion assignments for each kit, see the Preset Keyboard Percussion List on page 76.

The message “Are you sure you want to clear all assignments and setup data?” may appear when you change the kit. Select [CLEAR] to clear all assignments (made in the ASSIGN Page) and detailed settings (made in the SETUP Page) and call up the selected kit on the panel. Select [CANCEL] to call up the selected kit without erasing the assignments and detailed settings.

4 Adjust the volume and amount of reverb applied to the Keyboard Percussion.

Two sliders in the K.B.P. display determine the reverb and volume settings.

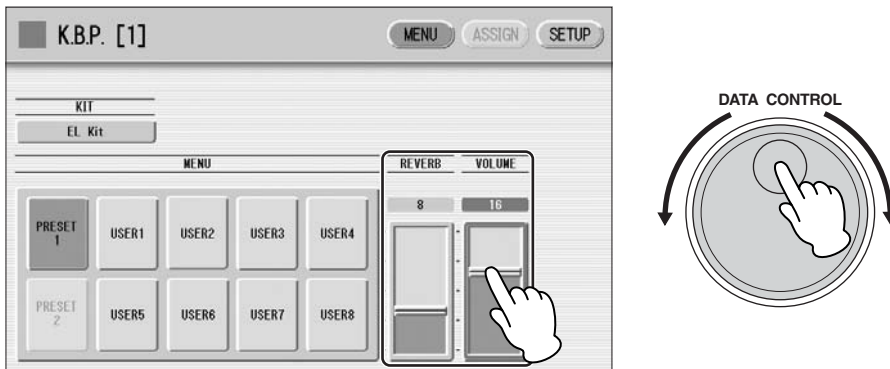

The settings here determine the reverb/volume for the entire Keyboard Percussion setup, not for each percussion instrument. You can, however, adjust each percussion instrument’s reverb/volume (page 83).

5 Play some notes on the keyboards.

Preset Keyboard Percussion List

		Multi Kit			Standard Kit 1 - Symphony Kit		
		Preset 2(PK)	Preset 1(LK)	Preset 1(UK)	Preset 2(PK)	Preset 1(LK)	Preset 1(UK)
C1	C#1	Bass Drum Heavy	-		Kick	-	
D1	D#1	SD Brush Roll	-		Side Stick	Surdo Mute	
E1		Snare Drum Heavy	-		Snare	Snare Open	
F1	F#1	SD Brush Shot 1	Claves		Hand Clap	Hi Q	
G1	G#1	SD Reverb 1	-		Snare Tight	Whip Slap	
A1	A#1	Snare Drum Light	-		Floor Tom L	Scratch H	
B1		Tom 3	Synth Tom 3		Hi-Hat Closed	Scratch L	
C2	C#2	Snare Drum Rim 1	Concert BD		Floor Tom H	Finger Snap	
D2	D#2	Tom 2	Synth Tom 2		Hi-Hat Pedal	Click Noise	
E2		Hi-Hat Close	Bass Drum Heavy		Low Tom	Metronome Click	
F2	F#2	Tom 1	Synth Tom 1		Hi-Hat Open	Metronome Bell	
G2	G#2	Hi-Hat Open	Bass Drum Light		Mid Tom L	Seq Click L	
A2	A#2	Ride Cymbal 1	Snare Drum Heavy	-	Mid Tom H	Seq Click H	-
B2		Synth Tom 3	SD Brush Roll	-	Crash Cymbal 1	Brush Tap	-
C3	C#3	Crash Cymbal 1	Snare Drum Heavy	-	High Tom	Brush Swirl	-
D3	D#3	Synth Tom 2	SD Brush Shot 1	-	Ride Cymbal 1	Brush Slap	-
E3		Orchestra Cymbal	SD Reverb 1	-	Chinese Cymbal	Brush Tap Swirl	-
F3	F#3	-	Snare Drum Light	-	Ride Cymbal Cup	Snare Roll	-
G3	G#3	Synth Tom 1	Tom 3	-	Tambourine	Castanet	-
A3	A#3	-	Snare Drum Rim 1	-	Splash Cymbal	Snare Soft	-
B3		Tom 2	Tom 2	-		Sticks	-
C4	C#4	Hi-Hat Close	Hi-Hat Close	-		Kick Soft	-
D4	D#4	Tom 1	Tom 1	-		Open Rim Shot	-
E4		Hi-Hat Open	Hi-Hat Open	-		Kick Tight	-
F4	F#4	Ride Cymbal 1	Ride Cymbal 1	-		Kick	Bongo H
G4	G#4	Orch Snare Drum	Orch Snare Drum	-		Side Stick	Bongo L
A4	A#4	Crash Cymbal 1	Crash Cymbal 1	-		Snare	Conga H Mute
B4		Snare Drum Roll	Snare Drum Roll	-		Hand Clap	Conga H Open
C5	C#5	Orchestra Cymbal	Orchestra Cymbal	-		Snare Tight	Conga L
D5	D#5	Orch Cymbal Roll	Orch Cymbal Roll	-		Floor Tom L	Timbale H
E5		Triangle Mute	Triangle Mute	-		Hi-Hat Closed	Timbale L
F5	F#5	Tambourine	Tambourine	-		Floor Tom H	Agogo H
G5	G#5	Triangle Open	Triangle Open	-		Hi-Hat Pedal	Agogo L
A5	A#5	Castanet	Castanet	-		Low Tom	Cabasa
B5		Cowbell 1	Cowbell 1	-		Hi-Hat Open	Maracas
C6	C#6	Timbale 1 Low	Timbale 1 Low	-		Mid Tom L	Samba Whistle H
D6	D#6	Timbale 1 High	Timbale 1 High	-		Mid Tom H	Samba Whistle L
E6		Wood Block Low	Wood Block Low	-		Crash Cymbal 1	Guiro Short
F6	F#6	Conga Low	Conga Low	-		High Tom	Guiro Long
G6	G#6	Wood Block High	Wood Block High	-		Ride Cymbal 1	Claves
A6	A#6	Conga High	Conga High	-		Chinese Cymbal	Wood Block H
B6		Bongo Low	Bongo Low	-		Ride Cymbal Cup	Wood Block L
C7	C#7	Agogo Low	Agogo Low	-		Tambourine	Cuica Mute
D7	D#7	Bongo High	Bongo High	-		Splash Cymbal	Cuica Open
E7		Agogo High	Agogo High	-		Cowbell	Triangle Mute
F7	F#7	Cuica Low	Cuica Low	-		Crash Cymbal 2	Triangle Open
G7	G#7	Hand Claps	Hand Claps	-		Vibraslap	Shaker
A7	A#7	Cuica High	Cuica High	-		Ride Cymbal 2	Jingle Bells
B7		Shaker	Shaker	-		-	Bell Tree
C8	C#8			-			-
D8	D#8			-			-
E8				-			-
F8	F#8			-			-
G8	G#8			-			-
A8	A#8			-			-
B8				-			-
C9	C#9			-			-
D9	D#9			-			-
E9				-			-
F9	F#9			-			-
G9	G#9			-			-
A9	A#9			-			-
B9				-			-
C10	C#10			-			-
D10	D#10			-			-
E10				-			-
F10	F#10			-			-
G10	G#10			-			-
A10	A#10			-			-
B10				-			-
C11	C#11			-			-
D11	D#11			-			-
E11				-			-
F11	F#11			-			-
G11	G#11			-			-
A11	A#11			-			-
B11				-			-
C12	C#12			-			-
D12	D#12			-			-
E12				-			-
F12	F#12			-			-
G12	G#12			-			-
A12	A#12			-			-
B12				-			-
C13	C#13			-			-
D13	D#13			-			-
E13				-			-
F13	F#13			-			-
G13	G#13			-			-
A13	A#13			-			-
B13				-			-
C14	C#14			-			-
D14	D#14			-			-
E14				-			-
F14	F#14			-			-
G14	G#14			-			-
A14	A#14			-			-
B14				-			-
C15	C#15			-			-
D15	D#15			-			-
E15				-			-
F15	F#15			-			-
G15	G#15			-			-
A15	A#15			-			-
B15				-			-
C16	C#16			-			-

⬜ : Indicates the keys of the DDK-7 keyboard and DDKU-P7.

*The 10 kits, Standard Kit 2 – Symphony Kit, have the same sound assignments as Standard Kit 1.

		SFX Kit 1			SFX Kit 2		
		Preset 2(PK)	Preset 1(LK)	Preset 1(UK)	Preset 2(PK)	Preset 1(LK)	Preset 1(UK)
C1	C#1	Cutting Noise 1	-		Phone Call	-	
D1	D#1	Cutting Noise 2	-		Door Squeak	-	
E1	E#1	-	-		Door Slam	-	
F1	F#1	String Slap	-		Scratch Cut	-	
G1	G#1	-	-		Scratch H 3	-	
A1	A#1	-	-		Wind Chime	-	
B1	B#1	-	-		Telephone Ring	-	
C2	C#2	-	-		-	-	
D2	D#2	-	-		-	-	
E2	E#2	-	-		-	-	
F2	F#2	Flute Key Click	-		CarEngnIgnition	-	
G2	G#2	-	-		Car Tires Squeal	-	
A2	A#2	-	-		Car Passing	-	
B2	B#2	-	-		Car Crash	-	
C3	C#3	-	-		-	-	
D3	D#3	-	-		-	-	
E3	E#3	-	-		-	-	
F3	F#3	-	-		-	-	
G3	G#3	-	-		-	-	
A3	A#3	-	-	Shower	-	-	Laugh
B3	B#3	-	-	Thunder	-	-	Scream
C4	C#4	-	-	Wind	-	-	Punch
D4	D#4	-	-	Stream	-	-	Heart Beat
E4	E#4	-	-	Bubble	-	-	Foot Steps
F4	F#4	-	-	Feed	-	-	-
G4	G#4	-	-	-	-	-	-
A4	A#4	-	-	-	-	-	-
B4	B#4	-	-	-	-	-	-
C5	C#5	-	-	Dog	-	-	Machine Gun
D5	D#5	-	-	Horse	-	-	Laser Gun
E5	E#5	-	-	Bird Tweet	-	-	Explosion
F5	F#5	-	-	-	-	-	Firework
G5	G#5	-	-	-	-	-	-
A5	A#5	-	-	Ghost	-	-	-
B5	B#5	-	-	Maou	-	-	-
C6		-	-	-	-	-	-

		Arabic Kit			Pop Latin Kit		
		Preset 2(PK)	Preset 1(LK)	Preset 1(UK)	Preset 2(PK)	Preset 1(LK)	Preset 1(UK)
C1	C#1	Kick Soft	-		Bongo H Open 1 f	-	
D1	D#1	Side Stick	-		Bongo H Open 3 f	-	
E1	E#1	Snare Soft	-		Bongo H Rim	-	
F1	F#1	Arabic Hand Clap	-		Bongo H Tip	-	
G1	G#1	Snare Drum	-		Bongo H Heel	-	
A1	A#1	Floor Tom L	-		Bongo H Slap	-	
B1	B#1	Hi-Hat Closed	-		Bongo L Open 1 f	Hand Clap	
C2	C#2	Floor Tom H	-		Bongo L Open 3 f	-	
D2	D#2	Hi-Hat Pedal	-		Bongo L Rim	-	
E2	E#2	Low Tom	-		Bongo L Tip	-	
F2	F#2	Hi-Hat Open	-		Bongo L Heel	Conga H Tip	
G2	G#2	Mid Tom L	-		Bongo L Slap	Conga H Heel	
A2	A#2	Mid Tom H	Nakarazan Dom	-	Timbale L Open	Conga H Open	-
B2	B#2	Crash Cymbal 1	Cabasa	-	-	Conga H Mute	-
C3	C#3	High Tom	Nakarazan Edge	-	-	Conga H SlapOpen	-
D3	D#3	Ride Cymbal 1	Hager Dom	-	-	Conga H Slap	-
E3	E#3	Crash Cymbal 2	Hager Edge	-	-	Conga H SlapMute	-
F3	F#3	Duhulla Dom	Bongo H	-	Paila L	Conga L Tip	-
G3	G#3	Tambourine	Bongo L	-	Timbale H Open	Conga L Heel	-
A3	A#3	Duhulla Tak	Conga H Mute	-	-	Conga L Open	-
B3	B#3		Conga H Open	-		Conga L Mute	-
C4	C#4		Conga L	-		Conga L SlapOpen	-
D4	D#4		Zagrouda H	-		Conga L Slap	-
E4	E#4		Zagrouda L	-		Conga L Slide	-
F4	F#4		Kick Soft	Katem Dom		Bongo H Open 1 f	Cowbell Top
G4	G#4		Side Stick	Katem Tak		Bongo H Open 3 f	-
A4	A#4		Snare Soft	Katem Sak		Bongo H Rim	-
B4	B#4		Arabic Hand Clap	Katem Tak		Bongo H Tip	-
C5	C#5		Snare Drum	Doff Tak		Bongo H Heel	Guiro Short
D5	D#5		Floor Tom L	Tabla Dom		Bongo H Slap	Guiro Long
E5	E#5		Hi-Hat Closed	Tabla Tak 1		Bongo L Open 1 f	-
F5	F#5		Floor Tom H	Tabla Tik		Bongo L Open 3 f	-
G5	G#5		Hi-Hat Pedal	Tabla Tak 2		Bongo L Rim	Tambourine
A5	A#5		Low Tom	Tabla Sak		Bongo L Tip	-
B5	B#5		Hi-Hat Open	Tabla Roll Edge		Bongo L Heel	-
C6	C#6		Mid Tom L	Tabla Flam		Bongo L Slap	-
D6	D#6		Mid Tom H	Sagat 1		Timbale L Open	Maracas
E6	E#6		Crash Cymbal 1	Tabel Dom		-	Shaker
F6	F#6		High Tom	Sagat 3		-	Cabasa
G6	G#6		Ride Cymbal 1	Tabel Tak		-	Cuica Mute
A6	A#6		Crash Cymbal 2	Sagat 2		-	Cuica Open
B6	B#6		Duhulla Dom	Rik Dom		Paila L	-
C7	C#7		Tambourine	Rik Tak 2		Timbale H Open	-
D7	D#7		Duhulla Tak	Rik Finger 1		-	-
E7	E#7		Cowbell	Rik Tak 1		-	-
F7	F#7		Duhulla Sak	Rik Finger 2		-	Triangle Mute
G7	G#7		Claves	Rik BrassTremolo		-	Triangle Open
A7	A#7		Doff Dom	Rik Sak		Paila H	-
B7	B#7		-	Rik Tik		-	Wind Chime
C8	C#8						
D8	D#8						
E8	E#8						
F8	F#8						
G8	G#8						
A8	A#8						
B8	B#8						
C9	C#9						
D9	D#9						
E9	E#9						
F9	F#9						
G9	G#9						
A9	A#9						
B9	B#9						
C10	C#10						
D10	D#10						
E10	E#10						
F10	F#10						
G10	G#10						
A10	A#10						
B10	B#10						
C11	C#11						
D11	D#11						
E11	E#11						
F11	F#11						
G11	G#11						
A11	A#11						
B11	B#11						
C12	C#12						
D12	D#12						
E12	E#12						
F12	F#12						
G12	G#12						
A12	A#12						
B12	B#12						

Assigning sounds to the User Keyboard Percussion

You can assign any desired drum and percussion sound to any key or pedal, and your original setups can be saved to eight memory locations: User 1 through User 8. The User setting saved in User memory location can be called up by using the [K.B.P.1] or [K.B.P.2] buttons.

In the instructions below, drum sounds are assigned to User 1 and called up with [K.B.P.1] button.

1 Turn on the Keyboard Percussion function by pressing the [K.B.P.1] button.

The K.B.P. display appears.

2 Press [USER 1] on the display.

This procedure assigns User 1 to the [K.B.P.1] button. You can call up the User 1 setting the next time you press the [K.B.P.1] button.

3 Select the desired percussion kit.

See page 75 for selecting the kit.

4 Press the [ASSIGN] button at the top right of the display to call up the ASSIGN Page.

In the ASSIGN Page, you can assign specific drum sounds to any of the keys.



5 Select the desired drum instrument that you wish to assign to a key.

Select the desired drum instrument category with the category buttons in the display. The drum instrument menu of the selected category appears.



Reference Page

Kit Assign List (page 85)

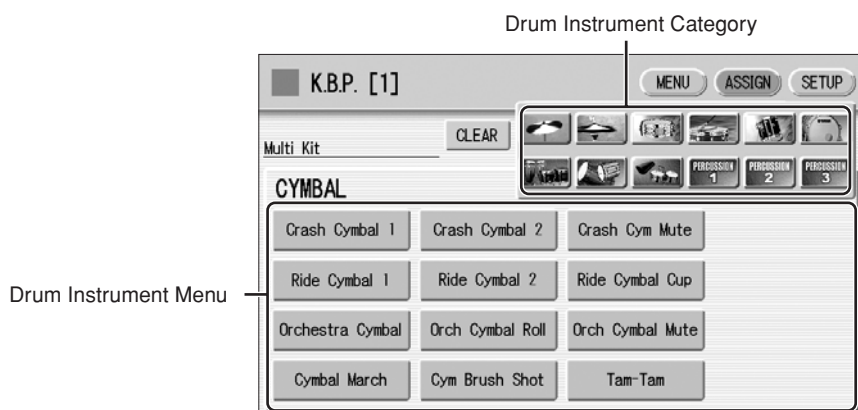

6 Assign an instrument to a particular key or pedal by simultaneously holding down the desired instrument name in the display and pressing the key (or pedal) to which the instrument is to be assigned.



NOTE
Though eight User Keyboard Percussion setups can be created, they cannot be memorized to Registration Memory. Only on/off data and the Keyboard Percussion Menu are memorized to Registration Memory.

The key to which the instrument is to be assigned

Instrument Name

Multi Kit CLEAR

CYMBAL

Crash Cymbal 1 Crash Cymbal 2 Crash Cym Mute

Ride Cymbal 1 Ride Cymbal 2 Ride Cymbal Cup

Orchestra Cymbal Orch Cymbal Roll Orch Cymbal Mute

Cymbal March Cym Brush Shot Tam-Tam

MENU ASSIGN SETUP

UK D3 Tam-Tam

PERCUSSION 1 PERCUSSION 2 PERCUSSION 3

Press the key.

Hold down the Instrument name...

When the assignment is complete, the key name and instrument name is displayed at the top of the display. The assignments are saved to the User memory selected in Step 2 (in this example, User 1).

7 Repeat the operation steps above as necessary to construct your own User Keyboard Percussion set.

To erase one instrument:

Simultaneously hold down the [CLEAR] button in the display (ASSIGN Page) and press the key (or pedal) corresponding to the instrument you wish to erase.

K.B.P. [1] UK D3 :Tam-Tam MENU ASSIGN SETUP

Multi Kit CLEAR

CYMBAL

Crash Cymbal 1 Crash Cymbal 2 Crash Cym Mute

Ride Cymbal 1 Ride Cymbal 2 Ride Cymbal Cup

Orchestra Cymbal Orch Cymbal Roll Orch Cymbal Mute

Cymbal March Cym Brush Shot Tam-Tam

PERCUSSION 1 PERCUSSION 2 PERCUSSION 3

Press the key.

The Keyboard Percussion setting you have created is automatically saved when you switch to another display. While data is being saved, the square at the top left of the display turns light blue for a few seconds. Do not turn the power off while the Keyboard Percussion settings are being saved.

To erase all instruments:

You can clear all assignments using the [CLEAR] button in the display (ASSIGN Page).

- 1 Press, then release the [CLEAR] button. The following display appears, prompting confirmation of the operation.

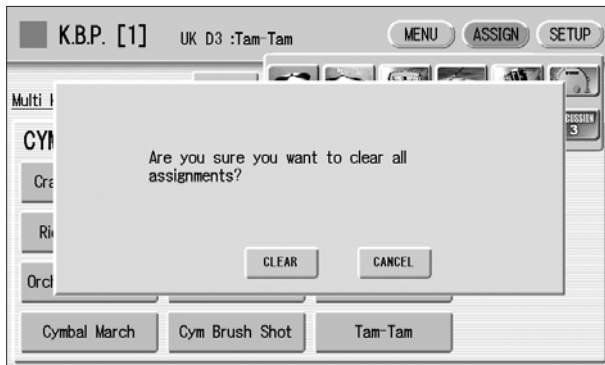

- 2 Press [CLEAR] in the display to erase all data. When [CLEAR] is selected, a “Completed” message momentarily appears on the display.

Press [CANCEL] in the display to abort the operation.

Copying the Keyboard Percussion settings

You can copy the Preset Keyboard Percussion to one of the User locations, or copy from one User location to another. In the instructions below, Preset 1 is copied to User 1.

- 1 Press the [K.B.P.1] button to copy Preset 1.
To copy Preset 1, select the [K.B.P.1] button; to copy Preset 2, select the [K.B.P.2] button. To copy either User location, select button [K.B.P.1] or [K.B.P.2].
- 2 Press the [MENU] button at the top right of the display to call up the MENU Page.

- 3** Within the Menu buttons, select the User location as the destination — for example, User 1.

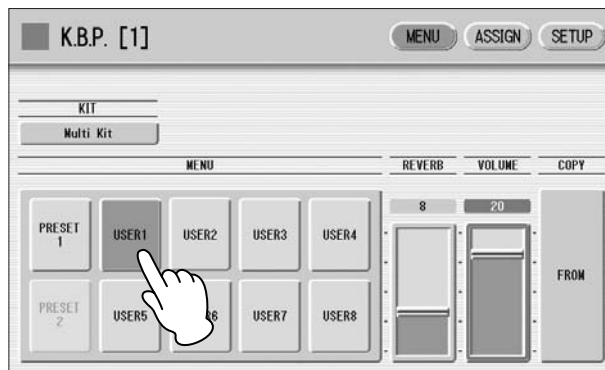

- 4** Press the COPY [FROM] button in the display. A list appears, letting you select the copy source location.

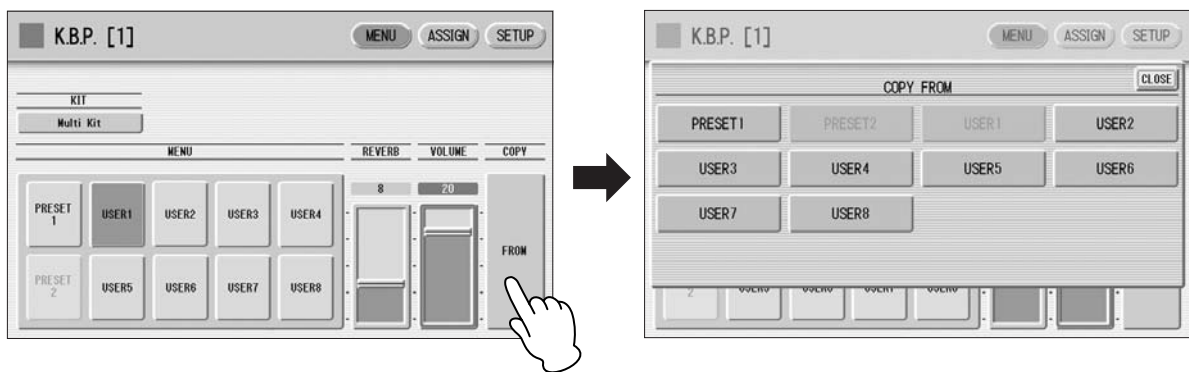

- 5** Select the copy source (Preset 1 here) from the list. A message appears, prompting confirmation of the operation.
- 6** Press the [COPY] button in the display to copy Preset 1. When [COPY] is selected, a “Completed” message momentarily appears in the display. Press the [CANCEL] button in the display to abort the operation.

Detailed settings for each percussion instrument

You can independently adjust the settings of pan, pitch, reverb and volume for each instrument. The settings here are system settings that cannot be memorized to Registration memory.

- 1 Turn off the volume of the relevant keyboard (the keyboard to which the instrument to be changed is assigned).
- 2 Press the [SETUP] button at the top right of the K.B.P. display to call up the SETUP Page.
- 3 Press the appropriate key (the key to which the instrument to be changed is assigned).
The selected instrument's name is shown on the display and you can change its settings.

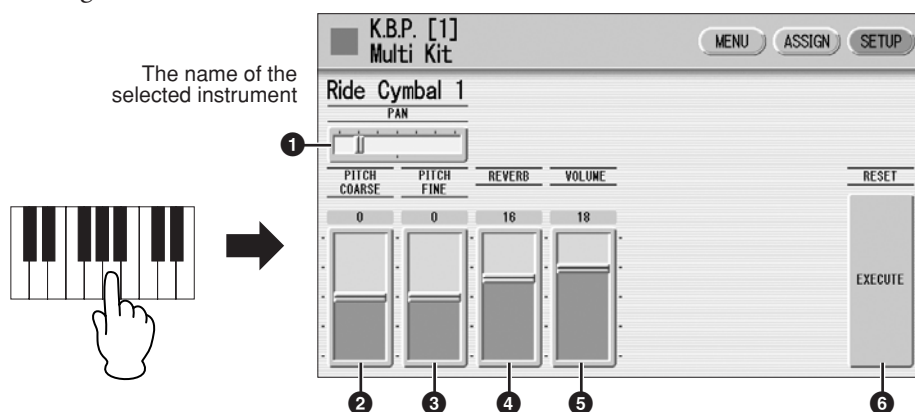

1 PAN

Determines the position of the currently selected instrument in the stereo image. Seven pan positions are available.

2 PITCH COARSE

Adjusts the pitch of the currently selected instrument by 100 cents.

Range: -64 – +63

3 PITCH FINE

Adjusts the pitch of the currently selected instrument by one cent, allowing more detailed tuning of the instrument than PITCH COARSE (2).

Range: -64 – +63

4 REVERB

Determines the amount of reverb applied to the currently selected instrument.

Range: 0 – 24

5 VOLUME

Determines the volume of the currently selected instrument.

Range: 0 – 24

6 RESET

Initializes settings such as pan, pitch, and reverb to their default values. Pressing the [EXECUTE] button calls up the following display, prompting confirmation of the operation.



Press the [EXECUTE] button in the display to restore (initialize) the default settings. When [EXECUTE] is selected, a “Complete” message momentarily appears on the display.

Press the [CANCEL] button in the display to abort the operation.

Kit Assign List

Multi Kit
CYMBAL
Crash Cymbal 1
Crash Cymbal 2
Crash Cym Mute
Ride Cymbal 1
Ride Cymbal 2
Ride Cymbal Cup
Orchestra Cymbal
Orch Cymbal Roll
Orch Cymbal Mute
Cymbal March
Cym Brush Shot
Tam-Tam
HI-HAT
Hi-Hat Open
Hi-Hat Close
Hi-Hat Pedal 1
Hi-Hat Pedal 2
Analog HH Open
Analog HH Close
SNARE DRUM
Snare Drum Light
Snare Drum Heavy
Snare Drum Rim 1
Snare Drum Rim 2
SD Accent 1
SD Accent 2
SD Reverb 1
SD Reverb 2
Synth Snare Drum
Orch Snare Drum
Snare Drum Roll
Analog SD
SNARE BRUSH
SD Brush Shot 1
SD Brush Shot 2
SD Brush Roll
TOM
Tom 1
Tom 2
Tom 3
Tom 4
Tom Brush Shot 1
Tom Brush Shot 2
Tom Brush Shot 3
Tom Brush Shot 4
Synth Tom 1
Synth Tom 2
Synth Tom 3
BASS DRUM
Bass Drum Light
Bass Drum Heavy
Bass Drum Attack
Synth Bass Drum
Bass Drum March
Concert BD
Analog BD Short
Analog BD Long
CONGA/BONGO
Conga High
Conga Low
Conga Slap
Conga Muff
Conga Slide
Bongo High
Bongo Low
Bongo Slap
Bongo Mute
CUICA/SURDO
Cuica High
Cuica Middle
Cuica Low
Tamborim Open
Tamborim Mute
Surdo Open
Surdo Mute
Surdo Rim
Surdo Muff
TIMBALES/COWBELL
Timbale 1 High

Timbale 1 Low
Timbale 2 High
Timbale 2 Low
Timbale 3 High
Timbale 3 Low
Timbale 4 High
Timbale 4 Low
Cowbell 1
Cowbell 2
Cowbell 3
Cowbell 4
PERCUSSION 1
Cabasa
Shaker
Maracas High
Maracas Low
Guiro Short
Guiro Long
Wood Block High
Wood Block Mid
Wood Block Low
Claves
Castanet
Vibraslap
PERCUSSION 2
Agogo High
Agogo Low
Triangle Open
Triangle Mute
Windbell Down
Windbell Up
Tambourine
Pandeiro
Bells
Hand Claps
Finger Snap
Scratch
Noise Percussion
PERCUSSION 3
Kotsuzumi 1
Kotsuzumi 2
Kotsuzumi 3
Kotsuzumi 4
Ohtsuzumi 1
Ohtsuzumi 2
Taiko 1
Taiko 2
Ohdaiko 1
Ohdaiko 2
Kakegoe 1
Kakegoe 2
Kakegoe 3

Standard Kit 1
CYMBAL
Crash Cymbal 1
Crash Cymbal 2
Splash Cymbal
Chinese Cymbal
Ride Cymbal 1
Ride Cymbal 2
Ride Cymbal Cup
Hi-Hat Open
Hi-Hat Closed
Hi-Hat Pedal
SNARE DRUM
Snare
Snare Tight
Snare Soft
Snare Roll
Side Stick
Open Rim Shot
Brush Tap
Brush Slap
Brush Swirl
Brush Tap Swirl
TOM
Floor Tom L
Floor Tom H
Low Tom
Mid Tom L

Mid Tom H
High Tom
BASS DRUM
Kick
Kick Tight
Kick Soft
PERCUSSION 1
Conga H Open
Conga L
Conga H Mute
Bongo H
Bongo L
Timbale H
Timbale L
Cowbell
Claves
Guiro Long
Guiro Short
Maracas
Vibraslap
PERCUSSION 2
Surdo Mute
Surdo Open
Cuica Mute
Cuica Open
Cabasa
Shaker
Agogo H
Agogo L
Samba Whistle H
Samba Whistle L
PERCUSSION 3
Tambourine
Castanet
Jingle Bells
Bell Tree
Triangle Open
Triangle Mute
Wood Block H
Wood Block L
Sticks
Whip Slap
Finger Snap
Hand Clap
PERCUSSION 4
Hi Q
Click Noise
Scratch H
Scratch L
Seq Click L
Seq Click H
Metronome Click
Metronome Bell

Standard Kit 2
CYMBAL
Crash Cymbal 1
Crash Cymbal 2
Splash Cymbal
Chinese Cymbal
Ride Cymbal 1
Ride Cymbal 2
Ride Cymbal Cup
Hi-Hat Open
Hi-Hat Closed
Hi-Hat Pedal
SNARE DRUM
Snare Short
Snare Tight H
Snare Soft 2
Snare Roll
Side Stick Light
Open Rim Shot H
Brush Tap
Brush Slap
Brush Swirl
Brush Tap Swirl
TOM
Floor Tom L
Floor Tom H
Low Tom

Mid Tom L
Mid Tom H
High Tom
BASS DRUM
Kick Short
Kick Tight
Kick Soft
PERCUSSION 1
Conga H Open
Conga L
Conga H Mute
Bongo H
Bongo L
Timbale H
Timbale L
Cowbell
Claves
Guiro Long
Guiro Short
Maracas
Vibraslap
PERCUSSION 2
Surdo Mute
Surdo Open
Cuica Mute
Cuica Open
Cabasa
Shaker
Agogo H
Agogo L
Samba Whistle H
Samba Whistle L
PERCUSSION 3
Tambourine
Castanet
Jingle Bells
Bell Tree
Triangle Open
Triangle Mute
Wood Block H
Wood Block L
Sticks
Whip Slap
Finger Snap
Hand Clap
PERCUSSION 4
Hi Q
Click Noise
Scratch H
Scratch L
Seq Click L
Seq Click H
Metronome Click
Metronome Bell

Hit Kit
CYMBAL
Crash Cymbal 1
Crash Cymbal 2
Splash Cymbal
Chinese Cymbal
Ride Cymbal 1
Ride Cymbal 2
Ride Cymbal Cup
Hi-Hat Open 2
Hi-Hat Closed 2
Hi-Hat Pedal 2
SNARE DRUM
Snare Ambient
Snare Tight 2
Snare Electro
Snare Roll
Stick Ambient
Snare Pitched
Brush Tap
Brush Slap
Brush Swirl
Brush Tap Swirl
TOM
Hybrid Tom 1
Hybrid Tom 2

Hybrid Tom 3
Hybrid Tom 4
Hybrid Tom 5
Hybrid Tom 6
BASS DRUM
Kick Tight H
Kick Wet
Kick Tight L
PERCUSSION 1
Conga H Open
Conga L
Conga H Mute
Bongo H
Bongo L
Timbale H
Timbale L
Cowbell
Claves
Guiro Long
Guiro Short
Maracas
Vibraslap
PERCUSSION 2
Surdo Mute
Surdo Open
Cuica Mute
Cuica Open
Cabasa
Shaker
Agogo H
Agogo L
Samba Whistle H
Samba Whistle L
PERCUSSION 3
Tambourine Light
Castanet
Jingle Bells
Bell Tree
Triangle Open
Triangle Mute
Wood Block H
Wood Block L
Sticks
Whip Slap
Finger Snap
Hand Clap
PERCUSSION 4
Hi Q
Click Noise
Scratch H
Scratch L
Seq Click L
Seq Click H
Metronome Click
Metronome Bell

Room Kit
CYMBAL
Crash Cymbal 1
Crash Cymbal 2
Splash Cymbal
Chinese Cymbal
Ride Cymbal 1
Ride Cymbal 2
Ride Cymbal Cup
Hi-Hat Open
Hi-Hat Closed
Hi-Hat Pedal
SNARE DRUM
Snare Snappy
Snare Tight Snap
Snare Soft
Snare Roll
Side Stick
Open Rim Shot
Brush Tap
Brush Slap
Brush Swirl
Brush Tap Swirl
TOM
Tom Room 1
Tom Room 2
Tom Room 3
Tom Room 4
Tom Room 5

Tom Room 6
BASS DRUM
Kick
Kick Tight
Kick Soft
PERCUSSION 1
Conga H Open
Conga L
Conga H Mute
Bongo H
Bongo L
Timbale H
Timbale L
Cowbell
Claves
Guiro Long
Guiro Short
Maracas
Vibraslap
PERCUSSION 2
Surdo Mute
Surdo Open
Cuica Mute
Cuica Open
Cabasa
Shaker
Agogo H
Agogo L
Samba Whistle H
Samba Whistle L
PERCUSSION 3
Tambourine
Castanet
Jingle Bells
Bell Tree
Triangle Open
Triangle Mute
Wood Block H
Wood Block L
Sticks
Whip Slap
Finger Snap
Hand Clap
PERCUSSION 4
Hi Q
Click Noise
Scratch H
Scratch L
Seq Click L
Seq Click H
Metronome Click
Metronome Bell

Rock Kit
CYMBAL
Crash Cymbal 1
Crash Cymbal 2
Splash Cymbal
Chinese Cymbal
Ride Cymbal 1
Ride Cymbal 2
Ride Cymbal Cup
Hi-Hat Open
Hi-Hat Closed
Hi-Hat Pedal
SNARE DRUM
Snare Rock
Snare Rock Tight
Snare Noisy
Snare Roll
Side Stick
Open Rim Shot
Brush Tap
Brush Slap
Brush Swirl
Brush Tap Swirl
TOM
Tom Rock 1
Tom Rock 2
Tom Rock 3
Tom Rock 4
Tom Rock 5
Tom Rock 6
BASS DRUM
Kick Gate

Kick 2
Kick Soft
PERCUSSION 1
Conga H Open
Conga L
Conga H Mute
Bongo H
Bongo L
Timbale H
Timbale L
Cowbell
Claves
Guiro Long
Guiro Short
Maracas
Vibraslap
PERCUSSION 2
Surdo Mute
Surdo Open
Cuica Mute
Cuica Open
Cabasa
Shaker
Agogo H
Agogo L
Samba Whistle H
Samba Whistle L
PERCUSSION 3
Tambourine
Castanet
Jingle Bells
Bell Tree
Triangle Open
Triangle Mute
Wood Block H
Wood Block L
Sticks
Whip Slap
Finger Snap
Hand Clap
PERCUSSION 4
Hi Q
Click Noise
Scratch H
Scratch L
Seq Click L
Seq Click H
Metronome Click
Metronome Bell

Electro Kit
CYMBAL
Crash Cymbal 1
Crash Cymbal 2
Splash Cymbal
Chinese Cymbal
Ride Cymbal 1
Ride Cymbal 2
Ride Cymbal Cup
Hi-Hat Open
Hi-Hat Closed
Hi-Hat Pedal
SNARE DRUM
Snare Noisy 2
Snare Noisy 3
Snare Snap Elec
Snare Roll
Side Stick
Open Rim Shot
Brush Tap
Brush Slap
Brush Swirl
Reverse Cymbal
TOM
Tom Electro 1
Tom Electro 2
Tom Electro 3
Tom Electro 4
Tom Electro 5
Tom Electro 6
BASS DRUM
Kick Gate Heavy
Kick Gate
Kick 3

PERCUSSION 1
Conga H Open
Conga L
Conga H Mute
Bongo H
Bongo L
Timbale H
Timbale L
Cowbell
Claves
Guiro Long
Guiro Short
Maracas
Vibraslap
PERCUSSION 2
Surdo Mute
Surdo Open
Scratch H 2
Scratch L 2
Cabasa
Shaker
Agogo H
Agogo L
Samba Whistle H
Samba Whistle L
PERCUSSION 3
Tambourine
Hi Q 2
Jingle Bells
Bell Tree
Triangle Open
Triangle Mute
Wood Block H
Wood Block L
Sticks
Whip Slap
Finger Snap
Hand Clap
PERCUSSION 4
Hi Q
Click Noise
Scratch H
Scratch L
Seq Click L
Seq Click H
Metronome Click
Metronome Bell

Analog Kit
CYMBAL
Crash Analog
Crash Cymbal 2
Splash Cymbal
Chinese Cymbal
Ride Cymbal 1
Ride Cymbal 2
Ride Cymbal Cup
Hat Open Analog
Hat Close Analog
Hat Close Anlg 2
SNARE DRUM
Snare Analog
Snare Analog 2
Snare Noisy 4
Snare Roll
Side Stick Anlg
Open Rim Shot
Brush Tap
Brush Slap
Brush Swirl
Reverse Cymbal
TOM
Tom Analog 1
Tom Analog 2
Tom Analog 3
Tom Analog 4
Tom Analog 5
Tom Analog 6
BASS DRUM
Kick Analog
Kick Anlg Short
Kick 3
PERCUSSION 1
Conga Analog M
Conga Analog L

Conga Analog H
Bongo H
Bongo L
Timbale H
Timbale L
Cowbell Analog
Claves 2
Guiro Long
Guiro Short
Maracas 2
Vibraslap
PERCUSSION 2
Surdo Mute
Surdo Open
Scratch H 2
Scratch L 2
Cabasa
Shaker
Agogo H
Agogo L
Samba Whistle H
Samba Whistle L
PERCUSSION 3
Tambourine
Hi Q 2
Jingle Bells
Bell Tree
Triangle Open
Triangle Mute
Wood Block H
Wood Block L
Sticks
Whip Slap
Finger Snap
Hand Clap
PERCUSSION 4
Hi Q
Click Noise
Scratch H
Scratch L
Seq Click L
Seq Click H
Metronome Click
Metronome Bell

Dance Kit
CYMBAL
Crash Analog
Crash Cymbal 2
Splash Cymbal
Chinese Cymbal
Ride Cymbal 1
Ride Analog
Ride Cymbal Cup
Hi-Hat Open 3
Hi-Hat Closed 3
Hat Close Anlg 3
SNARE DRUM
Snare Clap
Snare Dry
Snare Techno
Reverse Dance 2
Side Stick Anlg
Rim Gate
Snare Analog 3
Snare Analog 4
Vinyl Noise
Reverse Cymbal
TOM
Tom Dance 1
Tom Dance 2
Tom Dance 3
Tom Dance 4
Tom Dance 5
Tom Dance 6
BASS DRUM
Kick Techno
Kick Techno L
Kick Techno Q
PERCUSSION 1
Conga Analog M
Conga Analog L
Conga Analog H
Bongo Analog H
Bongo Analog L

Timbale H
Timbale L
Cowbell Dance
Claves 2
Guiro Long
Guiro Short
Maracas 2
Vibraslap Analog
PERCUSSION 2
Kick Dance 1
Kick Dance 2
Dance Breath 1
Dance Breath 2
Cabasa
Shaker
Agogo H
Agogo L
Samba Whistle H
Samba Whistle L
PERCUSSION 3
Tambourine Anlg
Hi Q 2
Jingle Bells
Bell Tree
Triangle Open
Triangle Mute
Dance Perc 3
Dance Perc 4
Snare Dance 1
Whip Slap
Finger Snap
Dance Clap
PERCUSSION 4
Hi Q
Click Noise
Scratch Dance 1
Scratch Dance 2
Dance Perc 2
Hi Q Dance 1
Dance Perc 1
Reverse Dance 1

Jazz Kit
CYMBAL
Crash Cymbal 1
Crash Cymbal 2
Splash Cymbal
Chinese Cymbal
Ride Cymbal 1
Ride Cymbal 2
Ride Cymbal Cup
Hi-Hat Open
Hi-Hat Closed
Hi-Hat Pedal
SNARE DRUM
Snare Jazz L
Snare Jazz M
Snare Jazz H
Snare Roll
Side Stick Light
Open Rim Shot
Brush Tap
Brush Slap
Brush Swirl
Brush Tap Swirl
TOM
Floor Tom L
Floor Tom H
Low Tom
Mid Tom L
Mid Tom H
High Tom
BASS DRUM
Kick Jazz
Kick Tight
Kick Soft
PERCUSSION 1
Conga H Open
Conga L
Conga H Mute
Bongo H
Bongo L
Timbale H
Timbale L
Cowbell

Claves
Guiro Long
Guiro Short
Maracas
Vibraslap
PERCUSSION 2
Surdo Mute
Surdo Open
Cuica Mute
Cuica Open
Cabasa
Shaker
Agogo H
Agogo L
Samba Whistle H
Samba Whistle L
PERCUSSION 3
Tambourine
Castanet
Jingle Bells
Bell Tree
Triangle Open
Triangle Mute
Wood Block H
Wood Block L
Sticks
Whip Slap
Finger Snap
Hand Clap
PERCUSSION 4
Hi Q
Click Noise
Scratch H
Scratch L
Seq Click L
Seq Click H
Metronome Click
Metronome Bell

Brush Kit
CYMBAL
Crash Cymbal 1
Crash Cymbal 2
Splash Cymbal
Chinese Cymbal
Ride Cymbal 1
Ride Cymbal 2
Ride Cymbal Cup
Hi-Hat Open
Hi-Hat Closed
Hi-Hat Pedal
SNARE DRUM
Brush Slap 3
Brush Tap 2
Brush Slap 2
Snare Roll
Side Stick Light
Open Rim Shot
Brush Tap
Brush Slap
Brush Swirl
Brush Tap Swirl
TOM
Tom Brush 1
Tom Brush 2
Tom Brush 3
Tom Brush 4
Tom Brush 5
Tom Brush 6
BASS DRUM
Kick Jazz
Kick Tight
Kick Soft
PERCUSSION 1
Conga H Open
Conga L
Conga H Mute
Bongo H
Bongo L
Timbale H
Timbale L
Cowbell
Claves
Guiro Long
Guiro Short

Maracas
Vibraslap
PERCUSSION 2
Surdo Mute
Surdo Open
Cuica Mute
Cuica Open
Cabasa
Shaker
Agogo H
Agogo L
Samba Whistle H
Samba Whistle L
PERCUSSION 3
Tambourine
Castanet
Jingle Bells
Bell Tree
Triangle Open
Triangle Mute
Wood Block H
Wood Block L
Sticks
Whip Slap
Finger Snap
Hand Clap
PERCUSSION 4
Hi Q
Click Noise
Scratch H
Scratch L
Seq Click L
Seq Click H
Metronome Click
Metronome Bell

Symphony Kit
CYMBAL
Hand Cymbal
Hand Cymbal 2
Splash Cymbal
Chinese Cymbal
Hand Cymbal S
Hand Cymbal 2 S
Ride Cymbal Cup
Hi-Hat Open
Hi-Hat Closed
Hi-Hat Pedal
SNARE DRUM
Band Snare
Band Snare 2
Snare Soft
Snare Roll
Side Stick
Open Rim Shot
Brush Tap
Brush Slap
Brush Swirl
Brush Tap Swirl
TOM
Floor Tom L
Floor Tom H
Low Tom
Mid Tom L
Mid Tom H
High Tom
BASS DRUM
Gran Cassa Mute
Gran Cassa
Kick Soft 2
PERCUSSION 1
Conga H Open
Conga L
Conga H Mute
Bongo H
Bongo L
Timbale H
Timbale L
Cowbell
Claves
Guiro Long
Guiro Short
Maracas
Vibraslap

PERCUSSION 2
Surdo Mute
Surdo Open
Cuica Mute
Cuica Open
Cabasa
Shaker
Agogo H
Agogo L
Samba Whistle H
Samba Whistle L
PERCUSSION 3
Tambourine
Castanet
Jingle Bells
Bell Tree
Triangle Open
Triangle Mute
Wood Block H
Wood Block L
Sticks
Whip Slap
Finger Snap
Hand Clap
PERCUSSION 4
Hi Q
Click Noise
Scratch H
Scratch L
Seq Click L
Seq Click H
Metronome Click
Metronome Bell

SFX Kit 1
SFX
Cutting Noise 1
Cutting Noise 2
String Slap
Flute Key Click
Shower
Thunder
Wind
Stream
Bubble
Feed
Ghost
Maou
Dog
Horse
Bird Tweet

SFX Kit 2
SFX 1
Phone Call
Telephone Ring
Wind Chime
Door Squeak
Door Slam
Scratch Cut
Scratch H 3
Laugh
Scream
Punch
Heart Beat
Foot Steps
SFX 2
CarEngnIgnition
Car Tires Squeal
Car Passing
Car Crash
Siren
Train
Jet Plane
Starship
Burst
Roller Coaster
Submarine
Machine Gun
Laser Gun
Explosion
Firework

Arabic Kit
ARABIC 1
Nakarazan Dom
Nakarazan Edge
Hager Dom
Hager Edge
Zagrouda H
Zagrouda L
Arabic Hand Clap
Duhulla Dom
Duhulla Tak
Duhulla Sak
Doff Dom
Doff Tak
ARABIC 2
Katam Dom
Katam Tak
Katam Sak
Tabla Dom
Tabla Tak 1
Tabla Tak 2
Tabla Sak
Tabla Tik
Tabla Roll Edge
Tabla Flam
Tabel Dom
Tabel Tak
ARABIC 3
Sagat 1
Sagat 2
Sagat 3
Rik Dom
Rik Tak 1
Rik Tak 2
Rik Sak
Rik Tik
Rik Finger 1
Rik Finger 2
Rik BrassTremolo
CYMBAL/SNARE DRUM
Crash Cymbal 1
Crash Cymbal 2
Ride Cymbal 1
Hi-Hat Open
Hi-Hat Closed
Hi-Hat Pedal
Snare Drum
Snare Soft
Side Stick
TOM/BASS DRUM
Floor Tom L
Floor Tom H
Low Tom
Mid Tom L
Mid Tom H
High Tom
Kick Soft
PERCUSSION
Conga H Open
Conga L
Conga H Mute
Bongo H
Bongo L
Cowbell
Claves
Cabasa
Tambourine

Pop Latin Kit
CONGA
Conga H Tip
Conga H Heel
Conga H Open
Conga H Mute
Conga H SlapOpen
Conga H Slap
Conga H SlapMute
Conga L Tip
Conga L Heel
Conga L Open
Conga L Mute
Conga L SlapOpen
Conga L Slap
Conga L Slide

BONGO
Bongo H Open 1 f
Bongo H Open 3 f
Bongo H Rim
Bongo H Tip
Bongo H Heel
Bongo H Slap
Bongo L Open 1 f
Bongo L Open 3 f
Bongo L Rim
Bongo L Tip
Bongo L Heel
Bongo L Slap
PERCUSSION 1
Timbale H Open
Timbale L Open
Paila H
Paila L
Cowbell Top
Tambourine
Guiro Long
Guiro Short
Maracas
Cuica Open
Cuica Mute
Cabasa
Shaker
PERCUSSION 2
Triangle Open
Triangle Mute
Wind Chime
Hand Clap

6 Registration Memory

Registration Memory allows you to store virtually all the settings you make on the panel and LCD, providing a convenient way to instantly change all Voice settings and rhythms while you're playing, with the simple touch of a single button on the Registration Memory panel. The buttons are conveniently located between the Upper and Lower keyboards for easy access while playing. Moreover, you can also recall the settings using the right footswitch on the Pedal Unit, or optional Foot Pedal. All Registrations in Registration Memory can also be saved to a USB flash memory or other external media.



Various types of basic Registrations have been programmed to the numbered Registration Memory buttons, 1 – 16. When you record your own Registration settings to a numbered button, the preset Registration for that button will be overwritten and erased as a result. When you initialize the Registration Memory (page 93), the preset settings will be recalled and your own Registration setting(s) will be erased and replaced with the factory defaults.

Contents

1 Storing Registrations89	5 Registration Shift94
2 Selecting Registrations91	• Setting the Registration Shift mode in the Regist Shift display94
3 Saving the Registration data to USB flash memory92	• Confirming the Registration Shift setting in the Voice Display97
4 Initializing Registration Memory93	6 Unifying a specific parameter99

1 Storing Registrations

Newly created Registrations you make can be stored to the Registration Memory panel buttons. All Registrations in Registration Memory can also be saved to a USB flash memory or other external media for future recall.

1 Create your original Registration.

2 While holding down the [M.] (Memory) button in the Registration Memory section, press the numbered button to which you wish to save your Registration.



Reference Pages

Selecting a Voice (page 26)
Selecting a Rhythm (page 60)
Voice Controls and Effects (page 40)

1. While holding down [M.] button...

2. Press desired numbered button.

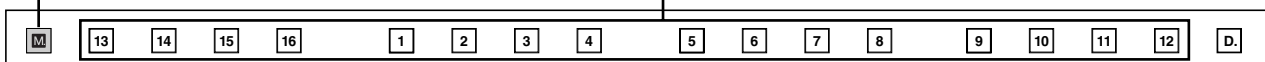

When the Registration is stored, the numbered button flashes momentarily.



When recording Registration settings, the square at the top left of the display turns light blue for a few seconds, indicating that the Registration is currently being saved. Do not turn the power off while the Registration is being saved.



Reference Page

Saving Registrations as
Registration Data (File)
(page 116)

Functions and settings that cannot be memorized:

The following settings cannot be stored to a Registration Memory number.

- Pitch (page 208)
- MIDI Control settings (page 238)
- Mic. Volume (page 233)
- AUX OUT settings (page 228)
- Mic. Reverb (page 233)
- LCD related settings (page 16)
- Internet Direct Connection settings (page 218)

The following settings common to all Registration Memory numbers 1 – 16 and cannot be stored individually for each number.

- Transpose (page 208)
- Attack mode in Organ Flute Voices (page 38)
- Registration Shift (page 94)
- Auto Fill setting (page 64)
- Reverb type (page 47)
- User Voices (page 145)
- User rhythms (page 172)
- User Keyboard Percussion (page 79)
- Rhythm Sequences (page 183)
- Disable setting (page 91)

2 Selecting Registrations

Simply press the numbered button that corresponds to the Registration you wish to select.

- You can also recall Registrations by using the Foot Controllers. This function is called “Registration Shift” (page 94).
- You can also program the Registrations to change automatically at specific points within the Rhythm Sequence. This function is called “Registration Sequence” (page 188).



Reference Page

Controlling the Registration Shift (page 203)

Using the [D.] (Disable) button:

Rhythm and automatic accompaniment patterns also change when you select different Registration Memory buttons. Pressing the [D.] (Disable) button allows you to keep the same rhythm, accompaniment patterns, tempo, and so on throughout all your Registration changes, or make your own rhythm selections if you want to.

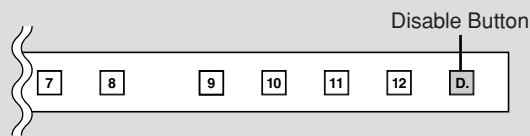

When the [D.] button is on, the following functions will not change, even when you change the Registration Memory number.

- Rhythm menu, Rhythm section, Rhythm tempo, Rhythm volume, Rhythm reverb
- Rhythm reverb time
- Accompaniment volume, Accompaniment reverb, On/Off status of Accompaniment parts
- A.B.C. mode, A.B.C. memory
- M.O.C. mode
- Second expression pedal control for rhythm tempo

3 Saving the Registration data to USB flash memory



Reference Page

Saving Registrations as Registration Data (File); (page 116)

You can save your Registration Memory settings to an external storage device, such as USB flash memory, with sixteen Registrations comprising a single file.

The instructions below explain how to save the Registration data to a USB flash memory. For details about using other external storage devices, see chapter 7, Music Data Recorder (M.D.R.).

- 1 Insert a USB flash memory into the USB TO DEVICE terminal on the left side of the DDK-7.
- 2 Press the [MDR] button on the panel to call up the M.D.R. display.

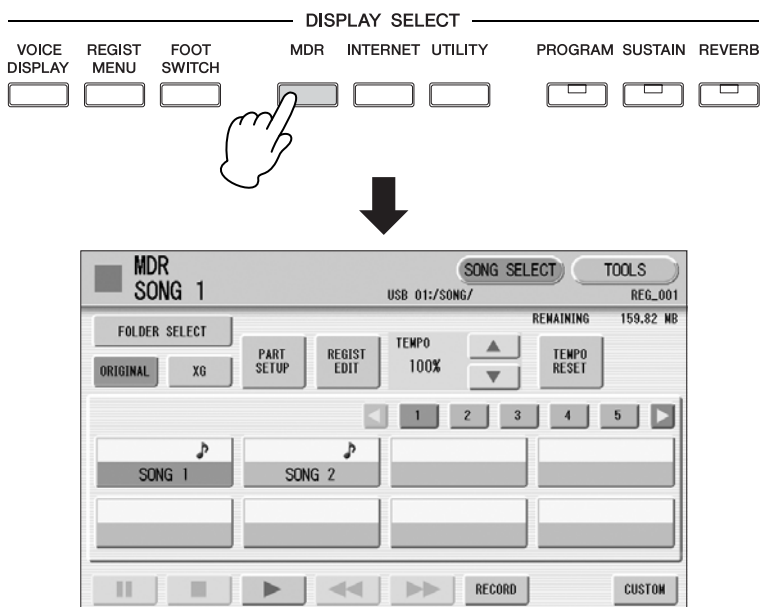

- 3 Select the song to which you want to save the Registration data (page 104).
- 4 Press [REGIST EDIT] button in the display to call up the Registration Edit display.
- 5 Press the [SAVE] button in the display.

A message appears, indicating the Registration data is currently being saved. When the operation is completed, the message closes.



Reference Page

Recalling Recorded Registrations (page 121)



Reference Page

Changing the Song Name (page 113)

4 Initializing Registration Memory

Deleting all Registration data in Registration Memory initializes the Registration Memory. Be careful when using this operation, since it erases all your existing data. In order to avoid inadvertently losing your important data, save it to an external storage device.



Reference Page

Factory Set (Initializing the DDK-7); (page 23)

- 1 Press the [UTILITY] button on the panel to call up the GLOBAL Page in the Utility display.

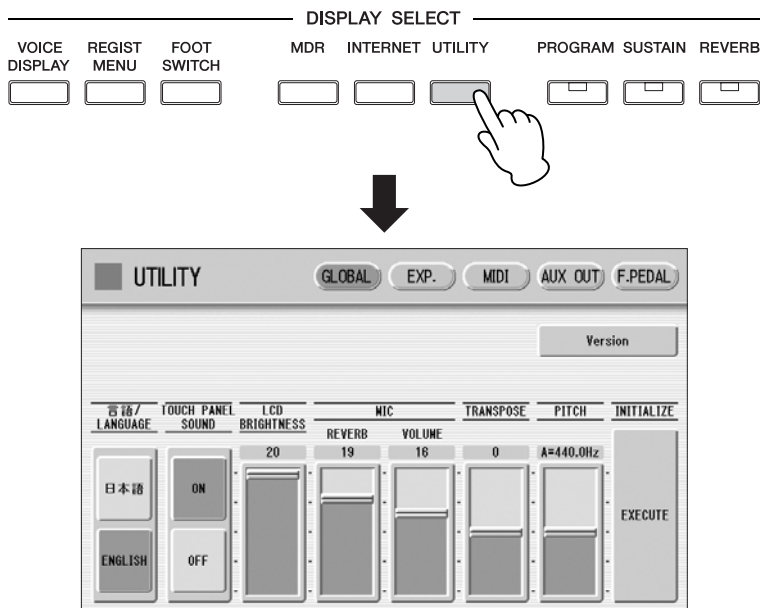

- 2 Press the INITIALIZE [EXECUTE] button on the right side in the display.

The message "Are you sure you want to initialize Registration data?" appears. Press [INITIALIZE] to actually initialize the data. When the operation is complete, the DDK-7 will be restarted. Press [CANCEL] to cancel the operation.

5 Registration Shift

The Registration Shift function allows you to change Registrations without taking your hands from the keyboards. By using the Right Footswitch on the expression pedal, or optional Foot Pedal, you can “jump” to a specified Registration or step through the panel Registrations in sequence, either in numeric order or in any order you specify. Registration Shift has three modes: Shift, Jump and User. These are set in the Regist Shift display. You can also view and check the Registration Shift mode in the Voice Display.



Reference Page

Footswitches (page 193)
Foot Pedal (page 196)

Setting the Registration Shift mode in the Regist Shift display

Connect the Pedal Unit (DDKU-P7) or optional Foot Pedal (FC4/FC5) to the instrument.

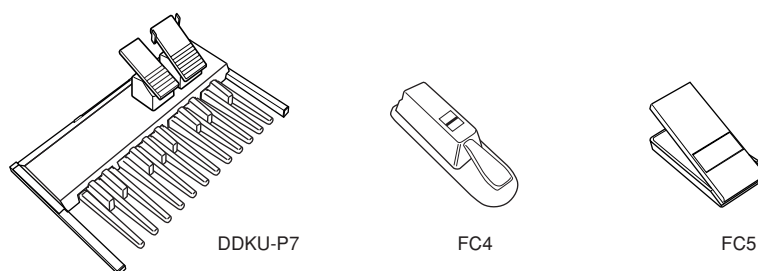

If you want to use the Foot Pedal, set the desired parameters in the Regist Shift display explained in this section, then assign the Regist Shift function to the Foot Pedal. Refer to the section “Controlling Registration Shift” on page 203.

Setting the Registration Shift mode in the Regist Shift display

- 1** Press the [FOOT SWITCH] button on the panel.
- 2** Press the [RIGHT] button at the top right of the display to call up the RIGHT Page (Regist Shift display).

REGIST SHIFT Display

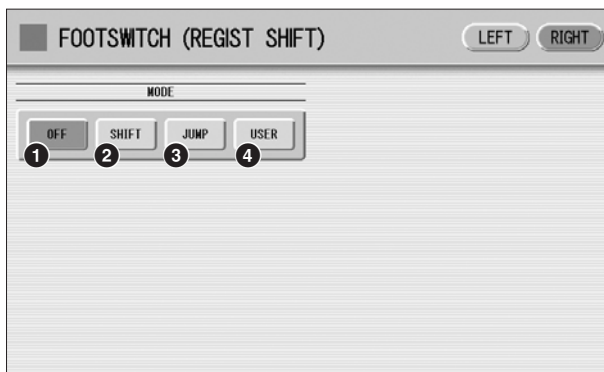

1 OFF

Turns off the Registration Shift assignment. When you select OFF, you cannot change Registrations by using the Right Footswitch, or with an optional Foot Pedal.

2 SHIFT

In the Shift mode, each press of the Right Footswitch, or with an optional Foot Pedal selects the Registration Memory presets in their numerical order. After the last Registration is reached, the function 'wraps around' to select the first preset again. The numbered buttons light up as they are selected.

3 JUMP

Pressing the Right Footswitch, or with an optional Foot Pedal jumps to select the designated panel Registration.

You can set the Jump "destination" with ▲ ▼ buttons in the display or the Data Control dial.

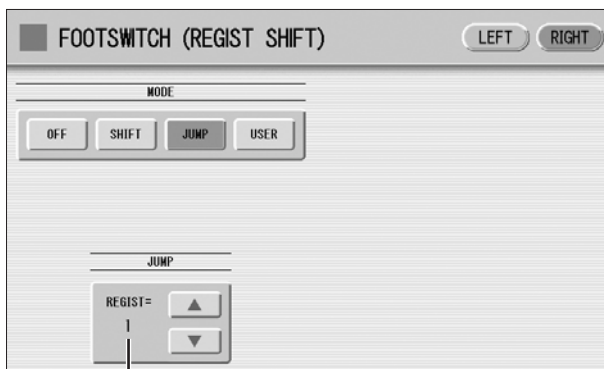

Registration number of the destination

4 USER

In the User mode, each press of the Right Footswitch, or with an optional Foot Pedal selects Registrations according to the order you've specified.

To set the User Registration order:

- 1 Press the desired numbered button in the Registration Memory section.
- 2 Press the [SET] button in the display.

The Registration number appears in the display, indicating that the Registration is entered.

3 Repeat the above procedure #1 through #2 to set the Registration order.



NOTE

When the cursor is positioned at "-", Footswitch, or an optional Foot Pedal does not work.

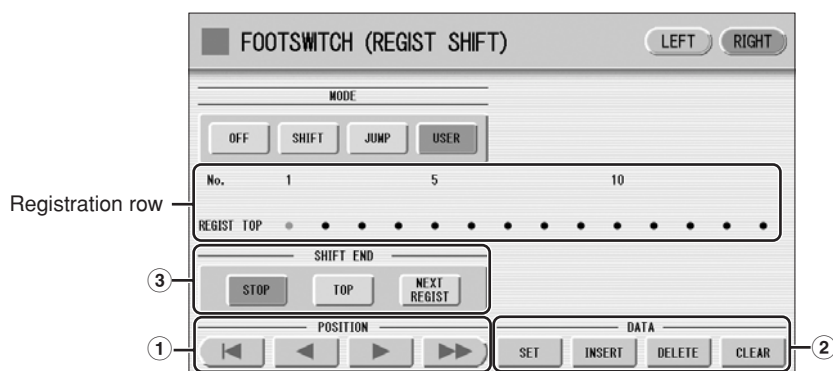

① POSITION

These are cursor controls used to move the cursor (colored orange) along the Registration row in the display. Entered Registration numbers are shown in boxes, while the numbers in the row above indicate the position in the sequence (in other words, the number of successive presses of the Right Footswitch). Up to 80 steps (Registrations) can be memorized.

- Moves the cursor to the first position.
- Moves the cursor one step to the left.
- Moves the cursor one step to the right.
- Moves the cursor five steps to the right.

② DATA

These are data controls used to enter and delete Registration numbers in the Registration row.

SET: For initially entering a Registration number to a blank space in the Registration row, or for replacing a number at the current cursor position.

To enter a number, press the desired Registration Memory button (the selected button will light), then press [SET] in the display. The entered Registration number will appear in the Registration row. After using SET to enter Registrations, the cursor can be moved among the numbers.

INSERT: For inserting a Registration number just before the current cursor position.

To perform the operation, first move the cursor to a numbered position. Then, press the desired Registration Memory button (the selected button will light), and press [INSERT] in the display. The new Registration number is inserted at the cursor position and all other numbers to the right of the cursor are moved to accommodate the new numbers.

Registration numbers cannot be entered beyond the Registration Shift function's capacity of 80. If the insert operation exceeds this capacity, a "Data Full" message appears and the operation cannot be executed.

DELETE: For deleting a Registration number at the current cursor position. To delete the unnecessary number, move the cursor to a numbered position and press [DELETE] in the display.

CLEAR: For erasing all current user Registration Shift settings.

After selecting [CLEAR], a message appears prompting confirmation of the operation.

Select [CLEAR] to clear all data. The message "Clear all data" momentarily appears in the display and returns to the previous display.

Select [CANCEL] to abort the operation.

③ SHIFT END

Determines how to end the Registration shift function.

STOP: Selects the last Registration and quits the operation.

TOP: After the last preset is reached, the first preset is called up again, starting the sequence over again from the beginning.

NEXT REGIST: After the last preset is reached, the next Registration data in the Song is called up. This function is available only when two or more Registration data sets are saved in one Song. This function is handy when you need to play a song with more than sixteen Registrations.

The Shift End mark () will automatically be put at the end of the Registrations you entered when Top or Next Regist is selected as the Shift End.



Reference Page

Saving Two or More Registration Banks to One Song (page 117)



NOTE

When you play the song using Next Regist. function, always press the [▶] (Play) button in the M.D.R. display to start the song and activate these functions. The [CUSTOM] (Custom Play) button will not activate the Next Regist. function.



NOTE

If the next Registration data contains User voices, the DDK-7 may produce no sound for a few seconds while loading the Registration.

Confirming the Registration Shift setting in the Voice Display

You can confirm the Registration Shift mode in the Voice Display, Page 1.

Press the [VOICE DISPLAY] button on the panel to call up the Voice Display.

The Registration Shift mode is shown at the bottom right of the display.

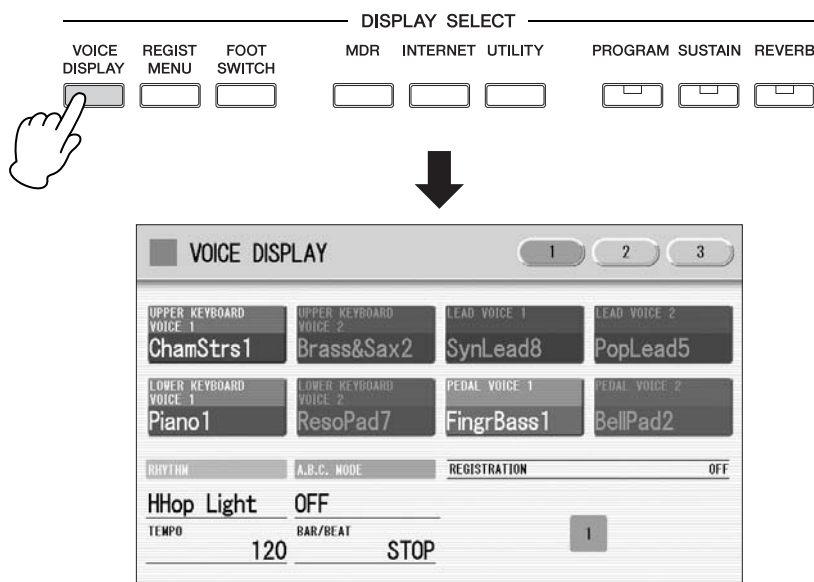

Registration Shift, OFF:

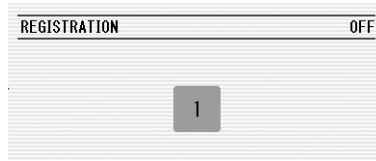

The current Registration number is displayed.

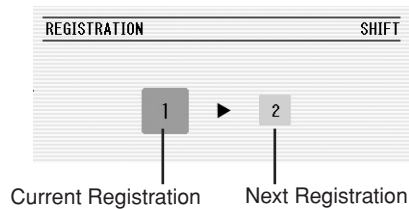

Registration Shift, in “SHIFT” mode:

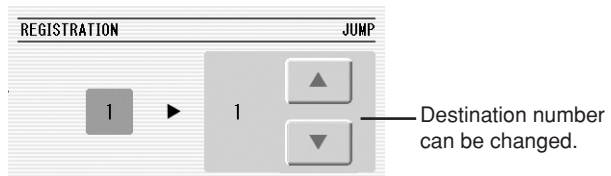

The current Registration number (left) and the next number (right) are displayed.

Registration Shift, in “JUMP” mode:





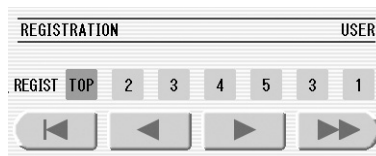

The current Registration number (left) and the destination number (right) will be displayed. You can change the destination number even in the middle of the performance by using the   buttons in the display or the Data Control dial.

Registration Shift, in “USER” mode:



Indicates the current position of the Registration Shift. You can change the Registration by moving the cursor (in orange) right/left, using the displayed buttons or the Data Control dial. This is handy if you've inadvertently advanced the shift setting in the middle of your performance. The user Registration settings cannot be edited here.

-  Moves the cursor to the first position.
-  Moves the cursor one step to the left and selects the next Registration.
-  Moves the cursor one step to the right and selects the previous Registration.
-  Moves the cursor five step to the right and selects the Registration.

6 Unifying a specific parameter

In the Voice Display, Page 2, you can conveniently “unify” a specific parameter used in different Voice groups at one time. This is useful when you are changing, for example, the Voice Brilliance setting for the Upper Keyboard and want the same setting to be applied to the entire instrument.

Available parameters

- Reverb
- Panning
- Rhythm Reverb
- Brilliance
- Volume
- Sustain

1 Press the [VOICE DISPLAY] button on the panel.

2 Press the [2] button at the top right of the display to select Page 2.

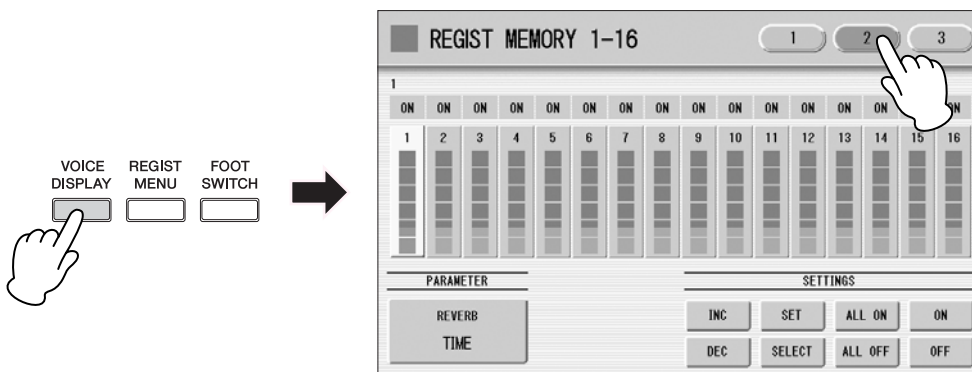

3 Press the PARAMETER button (indicates the currently selected parameter) in the display to select the desired parameter for changing.

The Parameter Select pop-up menu appears, letting you select the desired parameter.

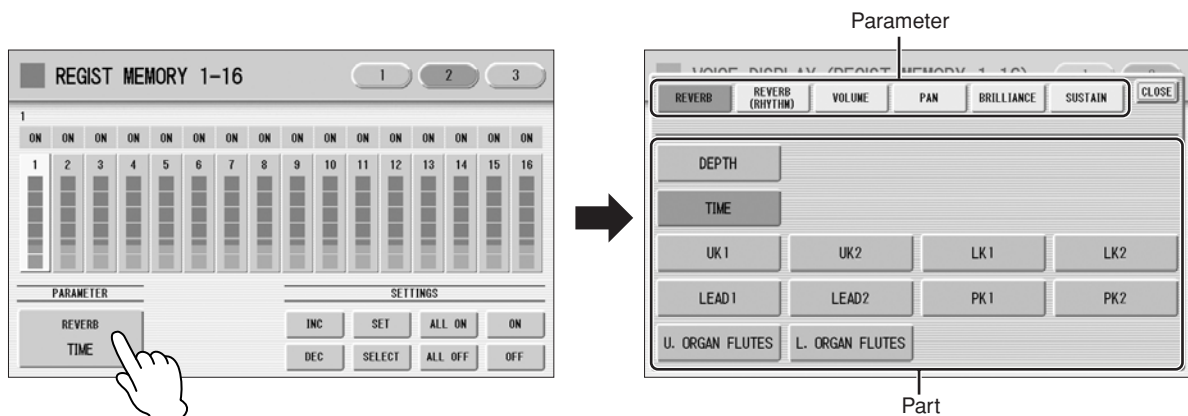

Select the parameter and part in the Parameter Select pop-up menu. After selecting the desired parameter, the pop-up menu automatically closes.

The amount of the selected parameter for each Registration is shown in the display.

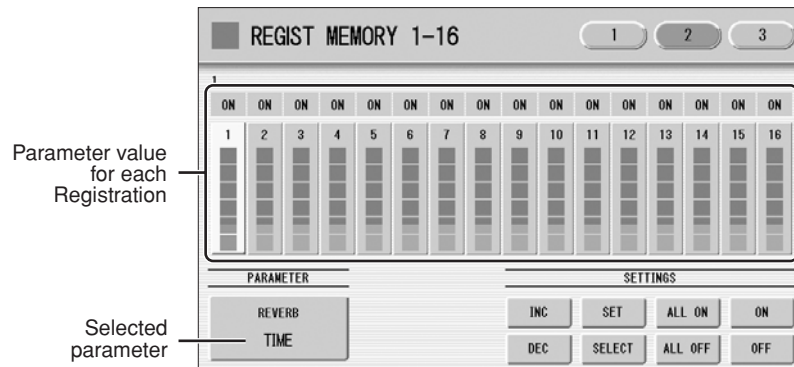

4 Select the targeted Registration numbers and turn them on.

Parameters in Registrations set to ON will be changed.

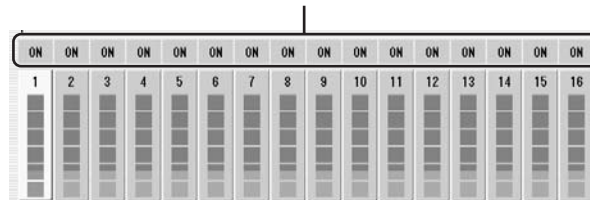

Press the targeted Registration in the display and turn it on with the SETTINGS buttons: ALL ON, ALL OFF, ON, OFF, and SELECT.

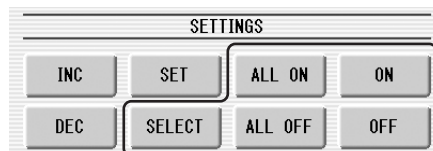

ALL ON: Selects all Registration memory numbers.

ALL OFF: Cancels all Registration memory numbers.

ON: Sets the currently selected Registration memory number to “ON.”

OFF: Sets the currently selected Registration memory number to “OFF.”

SELECT: Turns on the Registration memory numbers that contain the same Voice as the one which is currently set in the Registration at the cursor position. The targeted Registration numbers are underlined.

5 Unifies the currently turned-on parameter's values.

You unify the relevant parameter values in each Registration memory number or offset them. Keep in mind that you cannot restore the original data once you change the parameter's value.

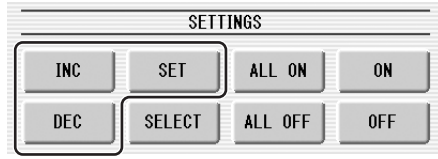

Unifying the currently turned-on parameter's value:

Pressing [SET] unifies the currently turned-on parameter's values to the one in the currently selected Registration (at the cursor position). A message appears prompting you to confirm the operation.

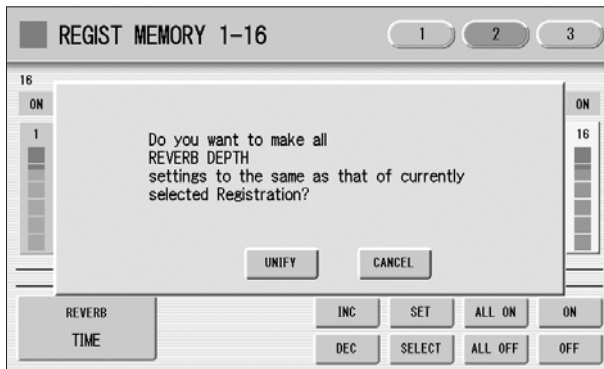

To continue the operation, select [UNIFY]. Select [CANCEL] to abort the operation.

Offsetting the currently turned-on parameter's value.

Pressing the [+]/[-] buttons in the display or using the Data Control dial offsets the currently turned-on parameter's value. If you select Pan as the parameter, [◀]/[▶] buttons are shown instead of [+]/[-].

If you change the value, and if parameter values for some Registration memory number reach the maximum or minimum, the following message appears.

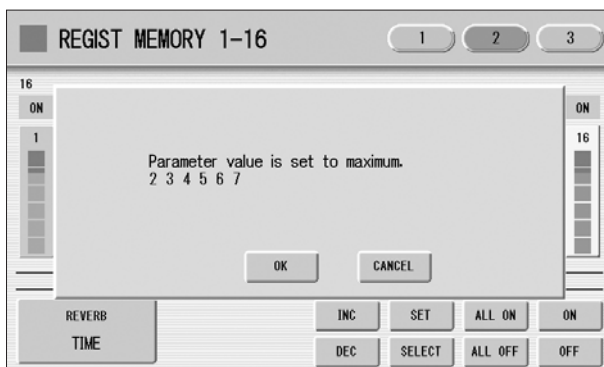

In this case, pressing [OK] continues the operation, ignoring those parameters at maximum or minimum value. Pressing [CANCEL] aborts the operation.

The Music Data Recorder (M.D.R.) is a sophisticated recording system built into the DDK-7 that lets you record your performances and Registration settings to a USB flash memory or other external media. Moreover, the M.D.R. allows you to perform various other operations to your song data (such as copy, delete and convert). Before purchasing any USB storage device, you should check with your Yamaha dealer or an authorized Yamaha distributor for advice on compatibility.

Contents

1 Calling Up the M.D.R. Display	103	7 Recalling Recorded Registrations	121
2 Formatting External Media	103	8 Playing Back a Song	122
3 Selecting a Song	104	• Playing Back the Selected Part(s)	123
• Song Icons	108	• Fast Forward, Rewind and Pause	123
4 Recording	110	• Changing the Tempo	124
• Recording your performance	110	• Repeat Playback	125
• Re-recording (Retry)	111	• Playing Back XG Songs	126
• Recording each part separately	111	9 Other Functions (Tools)	128
• Punch-in Recording	113	• Song Copy	128
5 Changing the Song Name	113	• Song Delete	129
6 Saving Registrations as Registration Data (File) .116		• Converting to XG	132
• Saving Two or More Registration Banks to One Song. 117		• XG Song Copy	133
• Replacing Registrations	118	• XG Song Delete	134
• Next Regist Settings (Changing the order of the Registration data)	118	• Converting to EL format	134
		• Converting from EL format	135
		• Checking the Remaining Memory/media ID	136

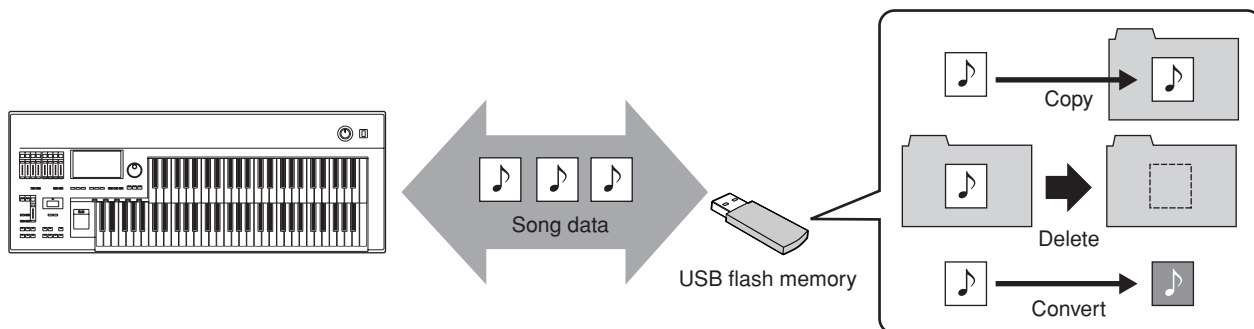

Before using a USB device, read through the important section “Precautions when using the USB TO DEVICE terminals” on page 234. About USB devices compatible with the DDK-7, see “Compatible USB devices” on page 234.

To protect your data (write-protect switch):

Some USB flash memory devices are equipped with a write-protect switch. To prevent accidental erasure of important data saved in USB flash memory, slide the write-protect switch on the device to the “protect” position. When saving data, make sure that the write-protect switch is set to the “overwrite” position.

1 Calling Up the M.D.R. Display

Press the [MDR] button in the panel to call up the M.D.R. display. All operations related to the M.D.R., such as recording and playing your performances, can be done in the M.D.R. display.

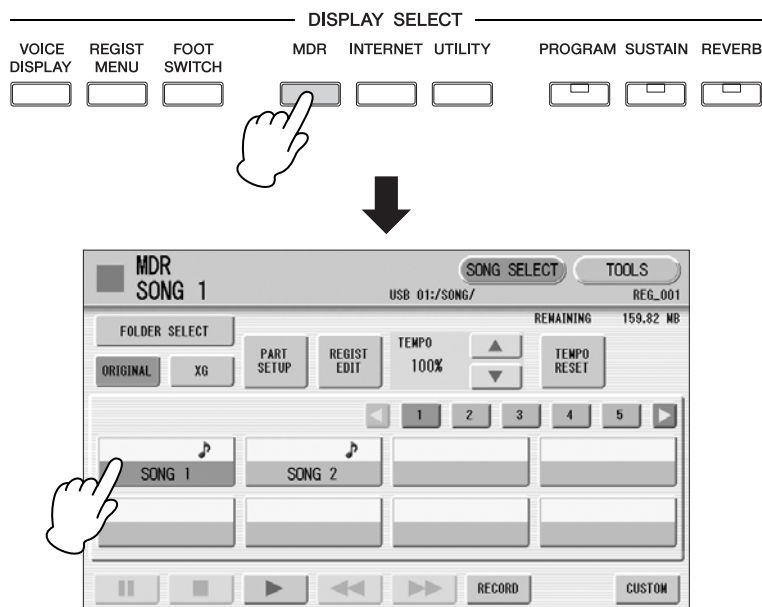

The M.D.R. display consists of two display pages: the SONG SELECT Page and the TOOLS Page. In the SONG SELECT Page, you can select the song that you want to playback, or to which you want to record your performance, then playback or record. The TOOLS Page has a variety of song utility operations, such as copy, delete, rename, etc.

Pressing any button other than the [MDR] button while the M.D.R. display is open exits from the M.D.R. display. If you exit from the function inadvertently, simply press the [MDR] button again to recall the M.D.R. display.

All the instructions in this chapter are related to the M.D.R. display. To call up the M.D.R. functions and the M.D.R. display, press the [MDR] button.

2 Formatting External Media

If you find that you are unable to use new, blank external media (such as USB flash memory, floppy disks or USB storage devices) or old ones that have been used with other devices, you may need to format them.

Formatting erases all the data in the media and makes it ready to record. The data erased by formatting will be lost permanently. Check whether or not the media contains any important data you wish to keep before executing the operation.

1 Connect the device to the USB TO DEVICE terminal.

2 Press the [TOOLS] button at the top right of the display to call up the TOOLS Page.

3 Press the [FORMAT] button in the display.

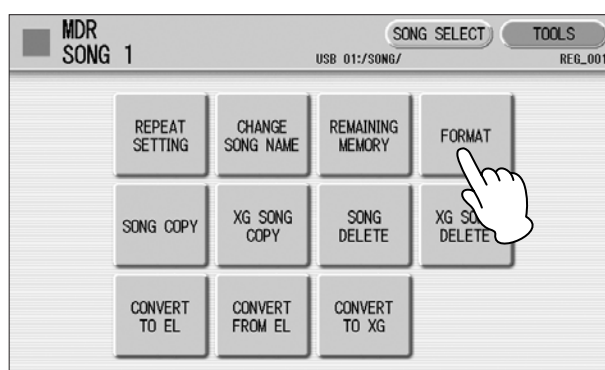

NOTE

"USB-FD01" appears in the display only when a floppy disk drive (UD-FD01) has been installed to the DDK-7.

4 Select the desired media you want to format.

To format a USB flash memory, select [USB XX]. To format a floppy disk, select [USB-FD1].

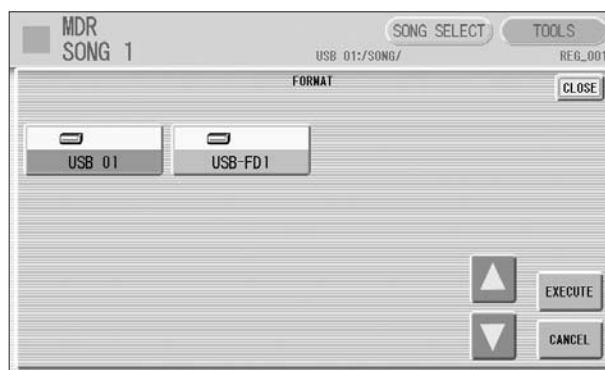

Do not remove the media while formatting.

5 Press the [EXECUTE] button in the display.

A message appears, prompting confirmation of the operation. Select [OK] to format the media, or [CANCEL] to abort the operation.

3 Selecting a Song

In the SONG SELECT Page, you can select a blank song to which you want to record your performance or save the Registration settings, or you can select a desired song for playback.

To select the desired song:

In the SONG SELECT Page, songs in the currently selected media are displayed. First call up the desired media (and folder, if necessary) in the display, then select the desired song.

1 Check the currently selected media at the top of the display.

For example, if you want to select a song in the USB flash memory, confirm that “USB XX: /” is displayed at the top of the display.

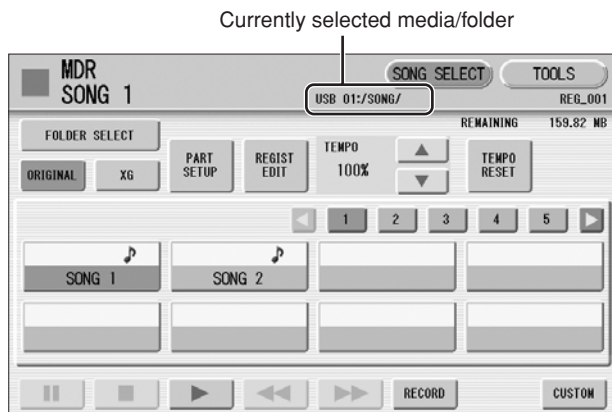

For information on selecting the desired media, see page 107.

2 Press desired song button in the display.

Referring to the song name and icons, select the desired song. The selected song button is highlighted in orange.



Reference Pages

- Changing the Song Name (page 113)
- Song Icons (page 108)

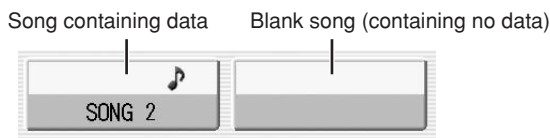

One display contains eight songs, Song 1 – Song 8. To change the display page and call up other songs, press the appropriate number buttons in the display. For example, pressing the [2] button calls up Song 9 –16, while the [3] button calls up Song 17 – 24, and so on.

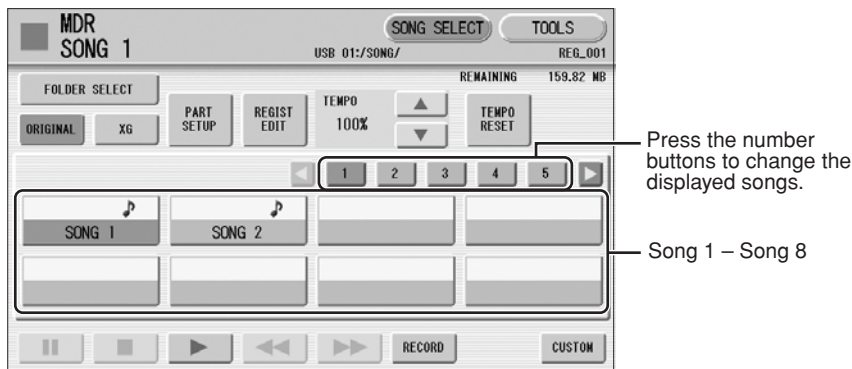

When the [1] button is selected

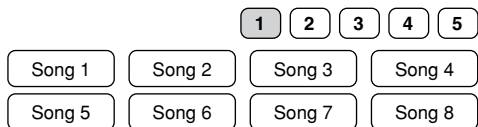

When the [3] button is selected

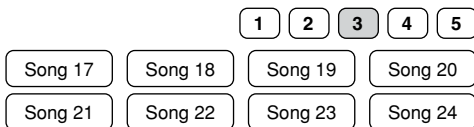

Song Part Information

Pressing the [PART SETUP] button calls up the Part Setup display of the currently selected song, letting you confirm which parts are played when playing the song.



When playing back the song (by pressing the [▶] button), only those parts that are set to “PLAY” in the Part Setup display actually play, while parts that are set to “OFF” are muted. (If the song contains no performance data, all parts are set to “OFF”.) You can change the status for each part by changing the PLAY/OFF settings for each part and pressing the [SAVE] button in the display.

To change the media/folder:

- 1 Press the [FOLDER SELECT] button in the SONG SELECT Page to call up the Folder Select display.

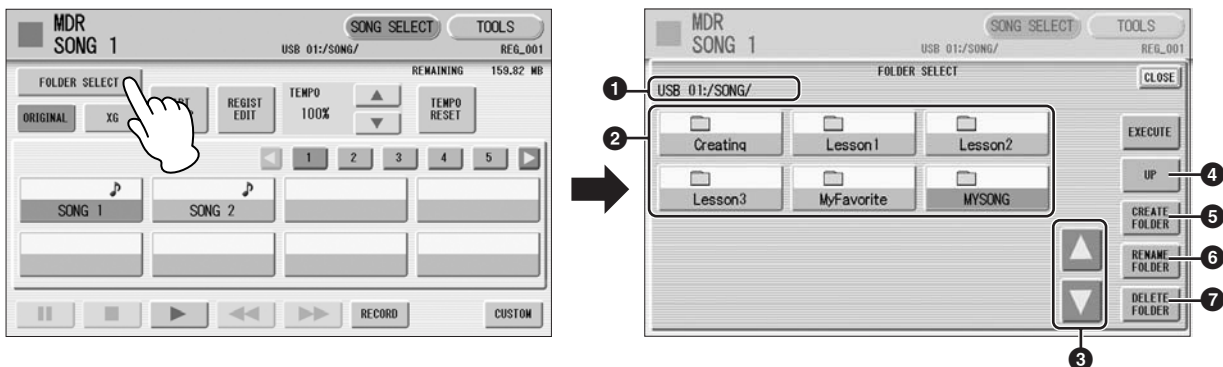

1 Current Media/Folder

Displays the currently selected media/folder. For example, if “USB 01:/Folder1/” is shown, the folder named “Folder1” in the USB flash memory is selected.

2 Media/Folder List

Displays the media or folders. Up to 120 folders can be displayed.

3 Scroll Buttons

If the Media/Folder List contains many folders, more than can fit on the display, you can scroll the display with these buttons.

4 UP

Selects the upper layer folder or media. For example, when “USB 01:/Folder1/” (Folder1 in the USB flash memory) is selected, pressing the [UP] button selects “USB 01:/”.

5 CREATE FOLDER

Creates a new folder in the Media/Folder List.

Up to 120 folders can exist in one media or within a single upper folder. Pressing this button calls up the New Folder display in which you can enter the desired name. Enter the name and press the [OK] button to create a new folder. The method for entering the folder name is the same as that of the song name. See page 113 for more information.

6 RENAME FOLDER

Calls up the Rename Folder display. You can change the folder name of the currently selected folder in the Media/Folder List. See page 113 for more information.

7 DELETE FOLDER

Deletes the folder that is selected in the Media/Folder List.







**NOTE**

A message prompting initialization of the Registration data may appear when you select a folder. Select [INITIALIZE] to initialize the Registration called up on the panel, then select a new Song. Media is not initialized after the operation is complete.



- 2 Select the desired media and/or folder in the Media/Folder List.**
To call up the folder in the media in the display, press the selected media button in the Media/Folder List again.
- 3 Press the [EXECUTE] button.**
To abort the operation, press the [CLOSE] button.

Song Icons

These icons are shown when you select a media, folder, and song.

	Indicates media such as a USB flash memory or floppy disk. This icon is displayed in the Media/Folder List.
	Indicates a folder.
	Indicates that write-protect or copy-protect is effective for the media.
	Indicates that performance data is contained in the song.
	Indicates a Protected Original Song. See page 131 for more information.
	Indicates a Protected Edit Song. See page 131 for more information.

These icons are shown when you select a song created on the Electone.

	Indicates a song that has been created with the ELS-01.
	Indicates a song that has been created with the ELS-01C or ELS-01X.
	Indicates a song that has been created with an EL-series Electone, such as the EL-900.

Media Contents: Folders, Songs, and Files

Folders:

A folder is a storage location in the media, used to organize multiple songs in groups. If you've saved hundreds of songs to a USB flash memory or USB storage device, it may be difficult to find the desired song quickly. Organizing your songs in folders, with similar songs grouped together (for example, according to genre or tempo), makes it easier to find the songs you want.

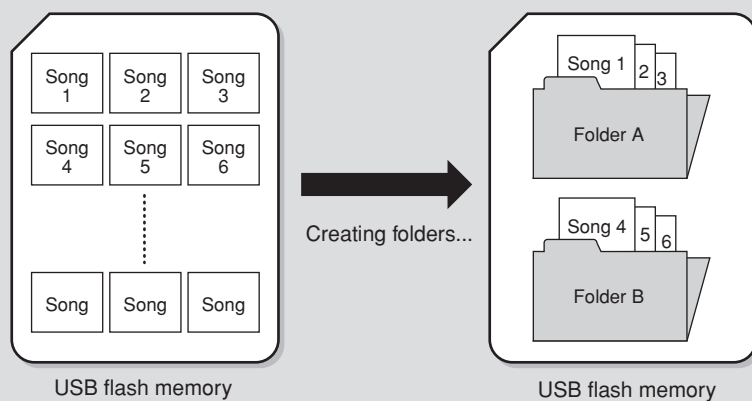

Songs:

A song is the DDK-7 data for a piece of music, recorded to external media. A single song can contain a variety of data, including the recorded performance, Registrations, and so on.

Files:

A file is an element of data in a song. For example, a single song consists of various files, such as Registration files and performance files. The following files are created with the M.D.R. (The extension will not appear in the DDK-7 display. They will, however, be displayed on a computer.)

Files in the song

File	Explanation	Extension
Performance data	This file contains performance data, played on the keyboards and pedals of the DDK-7.	.mid
Registration data	This file contains Registration settings, User Voices, User rhythms, and Rhythm Sequences.	.b00
XG-converted data	This file contains XG song data, for which DDK-7 performance data is converted to XG-compatible format.	.mid

In addition, one file (extension: .nam) is automatically created in each folder for organization/maintenance of the folder contents. It does not appear on the DDK-7 display.

4 Recording

Recording your performance



Never attempt to eject the media or turn the power off during recording, reading and playing back.

Set the desired Registrations on the DDK-7. Make all the DDK-7 settings necessary for the song you will record. This means entering the all Registrations you will need for the entire performance in the Registration Memory. Make sure also to select the Registration that you will use at the beginning of the song.

1 Insert a USB flash memory to the USB TO DEVICE terminal.

2 Select a blank song for recording your performance.

For details on selecting a song, see page 104.

If you want to overwrite an existing song already containing performance data, you will need to delete it beforehand.

3 Press the [RECORD] button in the display.

The following display appears, indicating that you can record your performance.

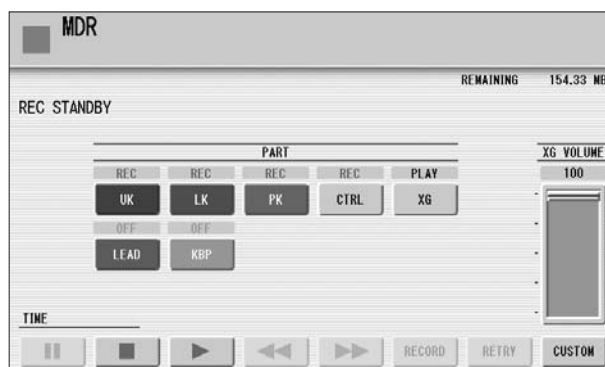

4 Press the [▶] (Play) button.

An hourglass icon appears, indicating that Registration data is currently being read.

5 After the hourglass disappears, begin playing.

6 When you finish playing, press the [■] (Stop) button in the display.

The recording is finished and the LCD returns to the SONG SELECT Page. The song to which your performance is recorded is automatically named “SONG XX” (xx indicates song number). You can change the song name as desired. (For details, see page 113.)



Do not remove the media from the instrument while data is being recorded (while the hourglass icon or other message is shown).



NOTE

You cannot record to a folder which contains songs for the EL-series Electone, such as EL-900.

Re-recording (Retry)

If you make a mistake during recording, you can re-record the song from the beginning.

- 1 Press the [RETRY] button while the song is still running.**
This automatically stops recording and returns you to the starting point of the song.

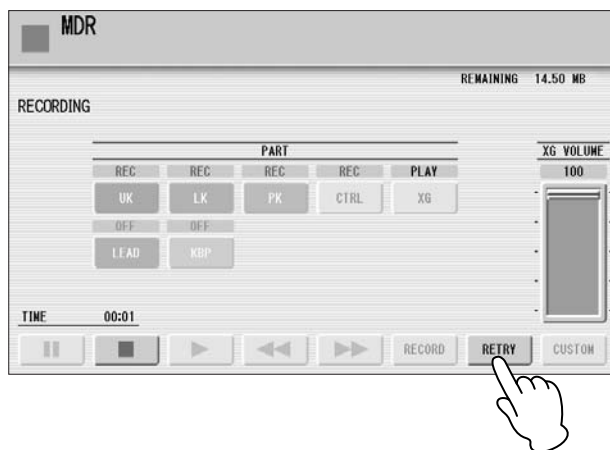

- 2 Press the [▶] (Play) or [CUSTOM] button to begin re-recording the song.**
Re-recording starts from the beginning of the song and replaces the previously recorded performance with the newly recorded performance.

Recording each part separately

You can also record the parts of your performance independently. This function lets you record Keyboard Percussion and performance control data, such as Registration changes and expression pedal operation, separately from the other parts of the song. Even Keyboard Percussion and Lead Voice 1 Voices can be recorded separately, though, the Lead Voice 2 Voices will be included in the performance data of the Upper Keyboard. The following instruction is an example: First, record the chords and bass to the song using the Lower and Pedalboard, and then record the melody using the Upper Keyboard.

- 1 Follow steps 1 – 3 on page 110 to call up the Rec Standby display.**

- 2 Select the parts for recording.**
Each pressing of a part button switches the status: PLAY, OFF, and REC.

PLAY: Playback the parts that have been recorded.

OFF: Recording or playback is not active.

REC: Records the part.

If you set the Upper part to “REC,” the performance on the Upper Keyboard (including Lead Voice 1 Voices) is recorded. Setting Lead to “REC,” however, records only the Lead Voice 1 Voices. You cannot set both Upper and Lead to “REC” at the same time; neither can the Lower and Keyboard Percussion parts be recorded at the same time.



NOTE

When you record the Keyboard Percussion, make sure that the [K.B.P.1] or [K.B.P.2] button is set to on.

The following setting lets you record only Lower Keyboard and Pedalboard parts.

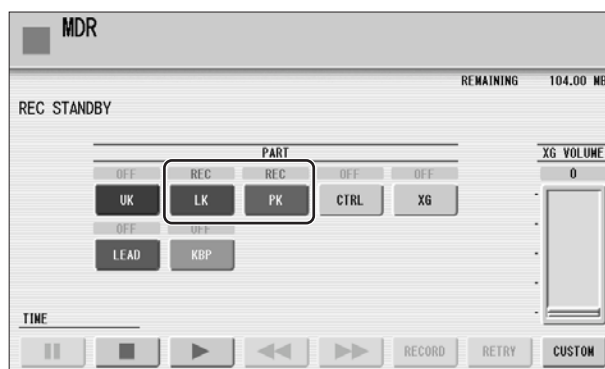

3 Press the [▶] (Play) button, and start playing after the hourglass icon disappears.

4 Press the [■] (Stop) button when you are finished with your performance to stop recording.

Now you've recorded the first parts of your performance.

5 Press the [RECORD] button to set up recording of the next part — Upper part in this case.

A message appears prompting confirmation of operation. Select [OK] to overwrite and the Rec Standby display appears.

6 Select the parts for recording.

Set the next parts you want to record (in this case, the Upper part) to "REC." Also set the part already recorded (in this case Lower and Pedal parts) to "PLAY," so you can hear the previously recorded parts as you record new ones.

7 Press the [CUSTOM] button to start recording of the new part or parts (Upper part).

Playback of the previously recorded parts starts immediately. The [CUSTOM] button is used here to record only the parts that have been selected for recording, and plays back only those parts that have been selected for playback. While you listen to the parts being played back, start playing the melody on the Upper keyboard.

When the end of the recorded performance is reached, playback is automatically stopped. The length of a subsequently recorded part cannot exceed the length of the previously recorded parts.

Punch-in Recording

This lets you re-record a specific phrase or section which you don't want to use, either that of a specific part(s) or all parts.



NOTE

This function is best used when the phrase to be re-recorded has definite beginning and end points, with slight pauses before and after.

- 1 Select the song which contains the phrase you want to change.**
For details on selecting a song, see page 104.
- 2 Press the [▶] (Play) button to start playback of the song.**
- 3 Press the [■■] (Pause) button at the point you want to execute punch-in recording.**
- 4 Press the [RECORD] button.**
The recording display appears, indicating that the Music Data Recorder is ready to record.
- 5 Set the parts which you want to change to “REC” status and other parts to “PLAY.”**
- 6 Press the [▶] (Play) button to start punch-in recording. Play the new phrase, as you want it to be changed.**
- 7 Press the [■] (Stop) button to quit the punch-in recording as soon as you reach the end of the phrase.**

5 Changing the Song Name

You can name the song, such as giving it a title or indicating the date on which it was recorded. However, song names of the EL-series Electone, such as the EL-900, cannot be changed.



NOTE

When you change the name of an XG song, the extension (.mid) cannot be changed.

- 1 Select the song whose name you want to change.**
For details on selecting a song, see page 104.
- 2 Press the [TOOLS] button at the top right of the display to call up the TOOLS Page.**

3 Press the [CHANGE SONG NAME] button. The following display appears.

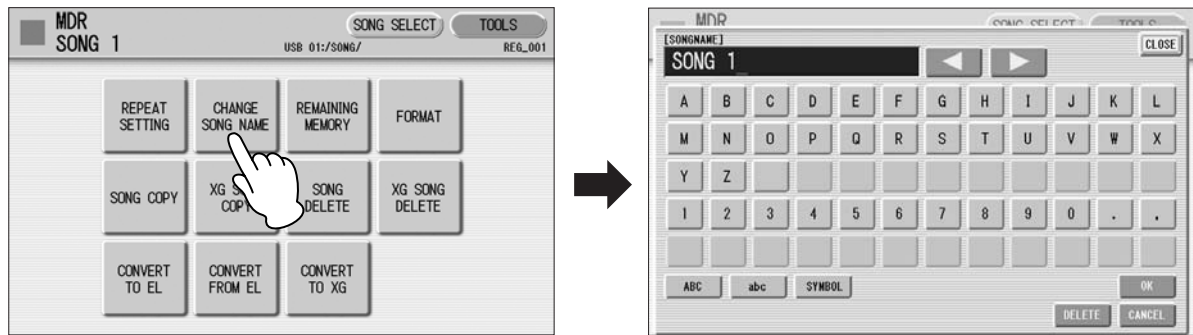

4 Move the cursor to the desired point by using the [◀][▶] buttons in the display or the Data Control dial.

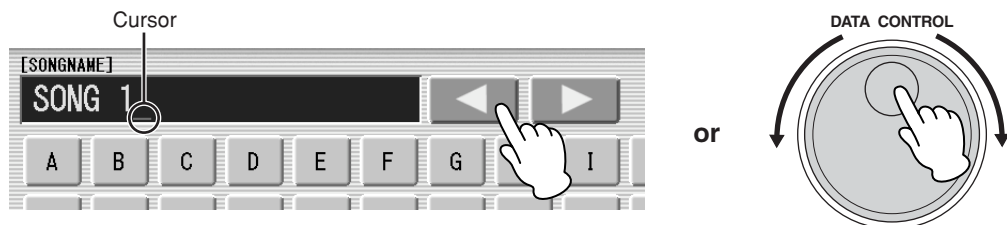

NOTE

If you select Japanese as the Language in the Utility display (page 16), you can also select Japanese language characters (hiragana and kanji, normal size katakana, half size katakana, full size alphabet, and full size symbols).

5 Select the desired character type: alphabet, upper or lowercase, or symbol.



NOTE

An XG song name can contain up to 46 characters.

6 Select the desired character for entry. A song name can contain up to 50 characters.

7 After finished, select [OK] to actually enter the name. The LCD will return to the TOOLS Page display.



To delete the entered character:

- 1 Move the cursor to the character you want to delete.

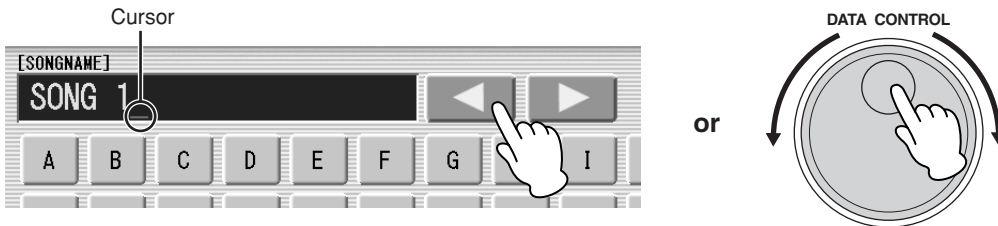

- 2 Press the [DELETE] button at the bottom right in the display.
The character is deleted.



To convert into kanji (Japanese language):

This applies only if you are using the **かな漢** (Kana-Kan) button in Japanese.

- 1 When the input “Hiragana” characters are shown in the reverse display (highlighted), press the **漢字変換** (kanji-conversion) button one or several times to convert to the characters into the appropriate kanji.
 - The reversed area can be changed by the [◀] [▶] buttons in the display or the Data Control dial.
 - The converted area can be cleared at once by pressing the **キャンセル** (cancel) button.
- 2 To actually enter the change, press the [OK] button or enter the next character. To enter the hiragana character itself (without converting it), press the **削除** (delete) button.

A “name is not available” message may appear when you press the [OK] button to finish entering the name. If this message appears, the name is invalid and you should enter another name.

The following names cannot be used. (“xx” indicates numbers.)

MDR_xx.EVT	ELS_SONG.NAM	MDR_xxx.TMP	TMP
MDR_xx.MID	MDR_xxx.MID	REG_xxx.TMP	TMPE02
MDR_xx.Bxx	REG_xxx.B00	ELS_SONG.TMP	
MDR_xx.Vxx	SONG_xxx.C02		
SONG.NAM			

6 Saving Registrations as Registration Data (File)

You can also record Registrations by themselves, without recording a performance. Bulk data, including Registration Memory and Registration Shift settings, Rhythm Patterns (User rhythms) Rhythm Sequence data, and User Voices, are also saved in the operation.

Registrations 1 – 16 stored to the numbered buttons are saved together as a bank.

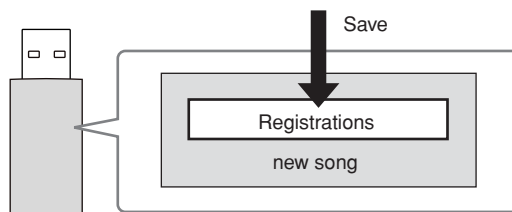
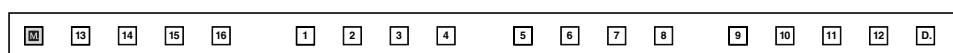

1 First create your original settings you want to save then select the destination (blank song).

For details on selecting a song, see page 104.

2 Press the [REGIST EDIT] button in the SONG SELECT Page to call up the Regist Edit display.

3 Press the [SAVE] button.

A message appears, indicating that the Registration is being recorded. After the message disappears, exit from the Regist Edit display by pressing the [CLOSE] button and return to the SONG SELECT Page. The song to which the Registration is recorded is automatically named “SONG XX” (xx indicates song number).

Saving Two or More Registration Banks to One Song

When you want to use more than 16 Registration numbers, you can save additional Registration banks to a single song, with the following procedure.

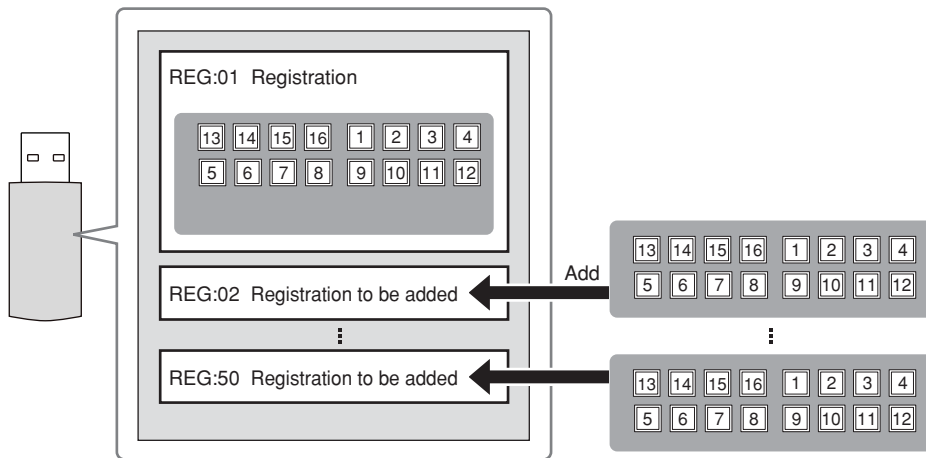

Reference Page

Next Regist. (page 97)
Programming a Registration Sequence (page 188)

1 First create the original settings you want to save, then select the destination song.

For details on selecting a song, see page 104.

2 Press the [REGIST EDIT] button in the SONG SELECT Page to call up the Regist Edit display.

The Registration data which has previously been saved to the song is shown.

3 Press the lowest blank (empty) Registration button.

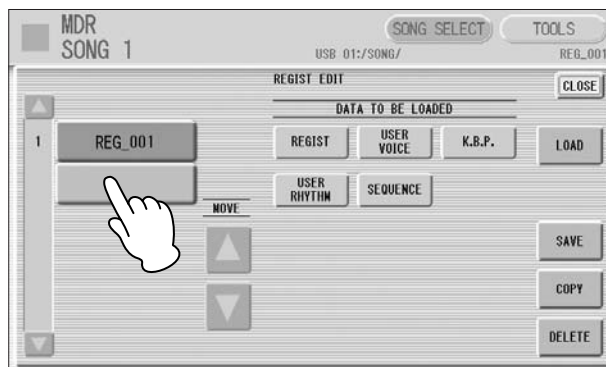

4 Press the [SAVE] button.

The Registration data will be added.

When you play back this song, the top Registration in this display will be loaded to the DDK-7. You can also change the order of the Registration data. See page 118.

Replacing Registrations

The M.D.R. also lets you change the Registrations of an existing song without changing the performance data. In advance, you need to create the original Registration that will replace the old one.

1 Select the song for which you wish to replace the Registrations.
For details on selecting a song, see page 104.

2 Press the [REGIST EDIT] button in the SONG SELECT Page to call up the Regist Edit display.
The Registration data which has been saved to the song is shown.

3 Select the Registration data you wish to replace.

4 Press the [SAVE] button.
A message appears, prompting confirmation of overwriting the Registration data. Select [OK] to overwrite (replace), or select [CANCEL] to abort the operation.

Next Regist Settings (Changing the order of the Registration data)

When playing back a song which uses more than 16 Registration numbers, you can use two or more Registration banks saved in a single song and recall them one by one as you play the song. This function is called Next Regist.



NOTE

If the next Registration data contains User voices, the DDK-7 may produce no sound for a few seconds while loading the Registration.

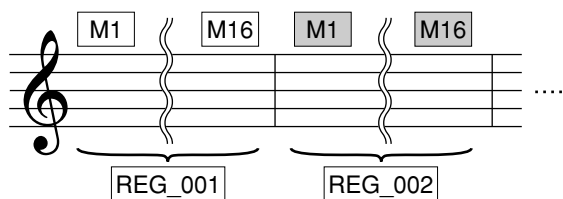

If you want to use the Next Regist function, you'll have to make one of the following settings in advance:

- Set the Registration Shift mode to User, and select Next Regist as the Shift End (page 94).
- Enter the Next Regist data in the Registration Sequence (page 189).

1 Save the desired Registrations to a song.
For instructions on saving two or more Registration banks to a song, see page 117.

2 Select the song containing the Registrations for which you want to change the order.

For details on selecting a song, see page 104.

3 Press the [REGIST EDIT] button in the SONG SELECT Page to call up the Regist Edit display.

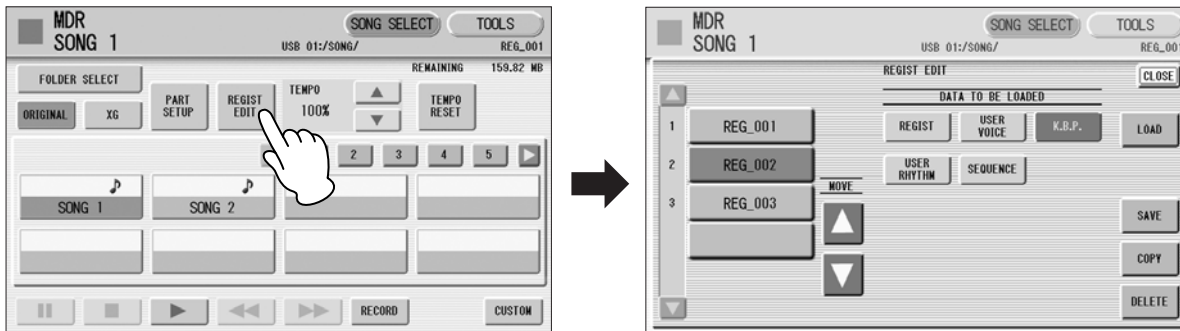

4 Change the Registration order, in the order you want to recall.

First select the specific Registration bank you want to edit, then move, copy or delete the selected data as needed to change the order.

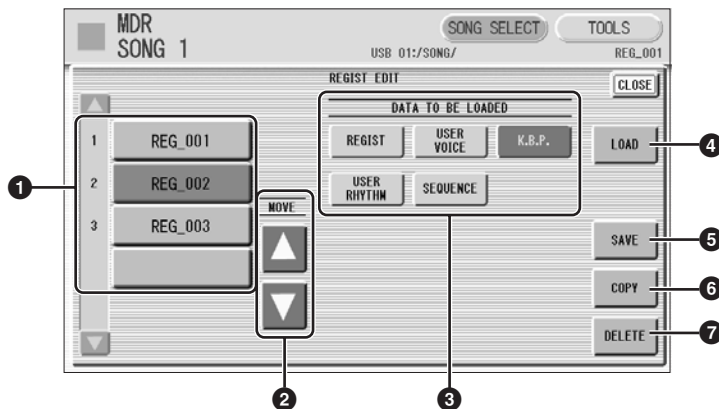

1 Registration Data List

From this list, select the Registration you want to move, copy or delete. The selected Registration is highlighted in orange. When more than five Registration banks are saved in the song, a scroll button  is available for scrolling through the Registration Data List.

2 MOVE

Moves the selected Registration bank up or down.

3 DATA TO BE LOADED

When loading the Registration bank to the panel, select the desired data you want to load. For more information, see page 121.

4 LOAD

Loads the selected Registration bank to the panel/keyboards. After loading, you can check the Registration by playing the keyboards.

5 SAVE

Saves the current panel settings as a Registration bank in the song. The currently selected Registration in the Registration Data List (1) will become the destination location.

6 COPY

Copies the currently selected Registration to the lowest blank location in the Registration Data List.

7 DELETE

Deletes the currently selected Registration bank in the Registration Data List.

5 Exit from the Regist Edit display by pressing the [CLOSE] button at the top right of the display.

7 Recalling Recorded Registrations

Registrations (and bulk data) recorded to song numbers can be easily loaded back to the DDK-7 by the following procedure.

The M.D.R. independently records the following five types of data:

- **REGIST**
- **USER VOICE**
- **K.B.P.**
- **USER RHYTHM**
- **SEQUENCE**

You can select and recall the desired data independently.

1 Insert the appropriate media and select the song you want to load back to the DDK-7.

For details on selecting a song, see page 104.

2 Press the [REGIST EDIT] button in the SONG SELECT Page to call up the Regist Edit display.

3 Select the Registration you want to load to the DDK-7.

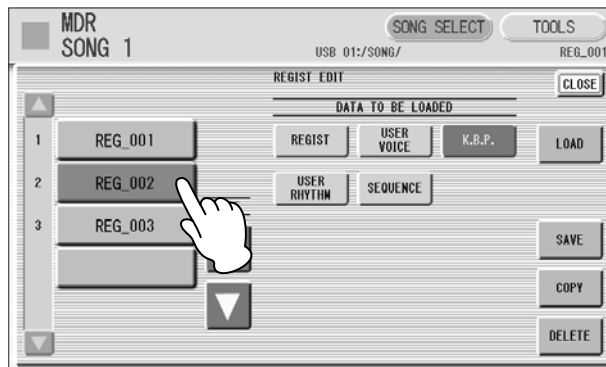

4 Using the five “DATA TO BE LOADED” buttons, select the desired data you want to load.

5 Press the [LOAD] button to load the selected data in the Registration.

6 Exit from the Regist Edit display by pressing the [CLOSE] button at the top right of the display.

When you select the protected song, the buttons (DATA TO BE LOADED) may be unavailable (grayed out). For example, combining a part of one protected song with another protected song is not allowed.



NOTE

When you load the Registration data by using the Next Regist function, all data will be loaded no matter which buttons you select here.



NOTE

If you are loading a Registration while a rhythm is playing, the sequence data and User rhythms in the Registration data cannot be loaded.

**NOTE**

When you play Electone data, the resulting song balance will vary according to the speakers you are using.

**NOTE**

The functions intended for control with the Knee Lever must be assigned to the Foot Pedal.

**Reference Page**

Next Regist Settings
(page 118)

**Reference Page**

Song Part Information
(page 106)

8 Playing Back a Song

1 Select the song to be played back.

For details on selecting a song, see page 104.

2 Press the [▶] (Play) button in the display to load the Registration data.

An hourglass icon appears, indicating the Registration data is loading.

If the song contains more than two Registration banks, the first one will be loaded. You can check the Registration order in the Regist. Edit display.

If the song contains no performance data, after loading the Registration data, the LCD returns to the SONG SELECT Page.

3 Playback starts automatically after reading the Registration data (the elapsed time is shown).

In general, all parts recorded to the song are played back; however, you can mute specific parts and playback only selected parts. For more information, see page 123.

When the end of the recorded performance is reached, playback automatically stops. You can, however, stop playback in the middle of the song by pressing the [■] (Stop) button in the display.

Custom Play

If you want to play back the song without resetting the Registrations, press the [CUSTOM] button instead of the [▶] (Play) button. This displays the song time and starts playback immediately.

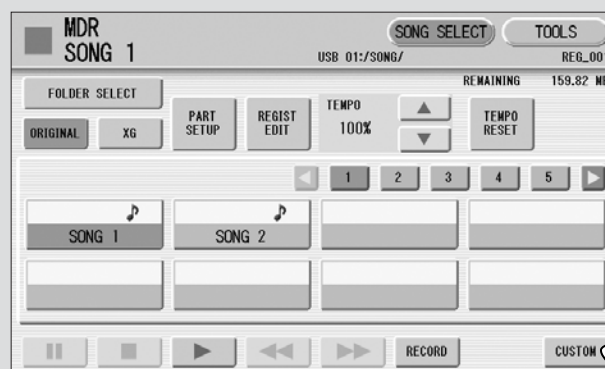

When you play the song using the Next Regist function, always press the [▶] (Play) button to start the song, not the [CUSTOM] button.

Playing Back the Selected Part(s)

You can also play back selected parts of your recorded performance, while other parts are temporarily turned off. This function is especially useful for playing a single part, such as the melody, over previously recorded accompaniment parts.

To play back the selected part(s):

During playback, press each part button to turn the part you want to playback to “PLAY” and the part you want to mute to “OFF.”

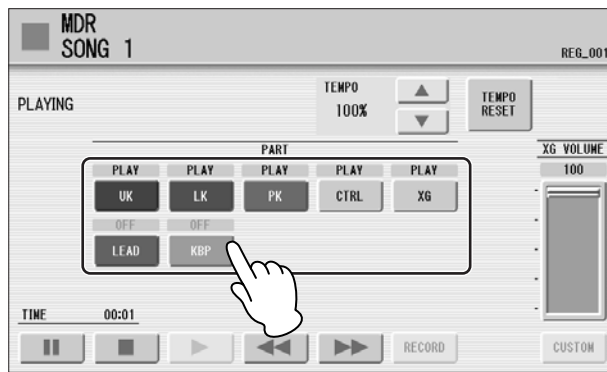

Fast Forward, Rewind and Pause

Fast Forward and Rewind:

During playback, press the [▶▶] (Fast forward) button or [◀◀] (Rewind) button and hold it down until the time reaches the desired position.

Even when the button is released, playback is paused. To resume playback from the point you’ve advanced or reversed to, press the [▶] (Play) button or [CUSTOM] button.

Pause:



If you want to temporarily stop playback of the song or songs, press the [■] (Pause) button.

To resume playback from the point at which the song was paused, press the [■] (Pause) button again or press the [▶] (Play) or [CUSTOM] button.

Changing the Tempo

You can change the tempo of the song as the song is playing in the M.D.R. display, either while the song is stopped or while it is playing.

To Change the Tempo:

Use the TEMPO   buttons in the display to change the tempo. (The TEMPO buttons on the panel cannot be used to change the tempo for the Music Data Recorder.) The range is 50 – 200%. The original recorded tempo is 100% and values less than 100% indicate slower tempo; values greater than 100% indicate faster tempo.

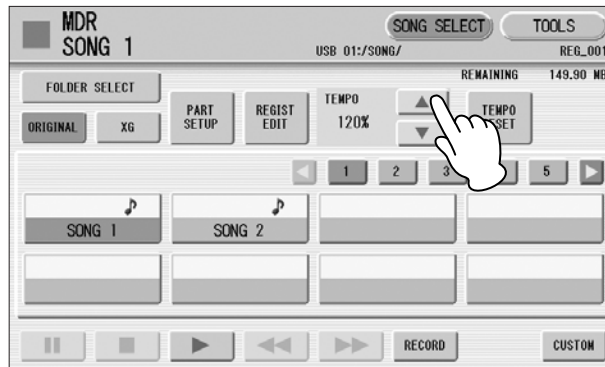

To reset the changed tempo:

Use the [TEMPO RESET] button in the display to reset the tempo to its original value (100%).

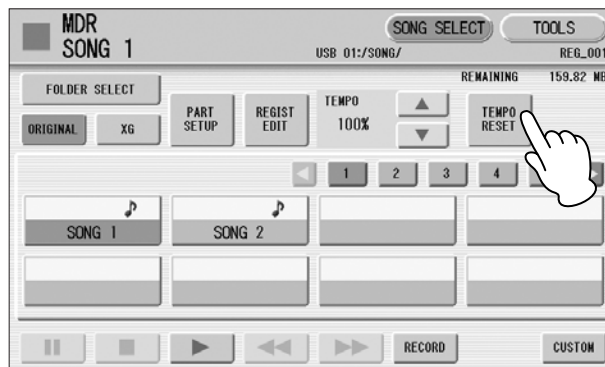

Repeat Playback

This feature allows you to repeatedly play back either all songs on a folder or only one specific song.

- 1 Select the song you wish to play back.**
If you wish to play back all songs on a folder, select the first song that will be played back. For details on selecting a song, see page 104.
- 2 Press the [TOOLS] button at the top right of the display to call up the TOOLS Page.**
- 3 Press the [REPEAT SETTING] button to call up the Repeat Setting display.**

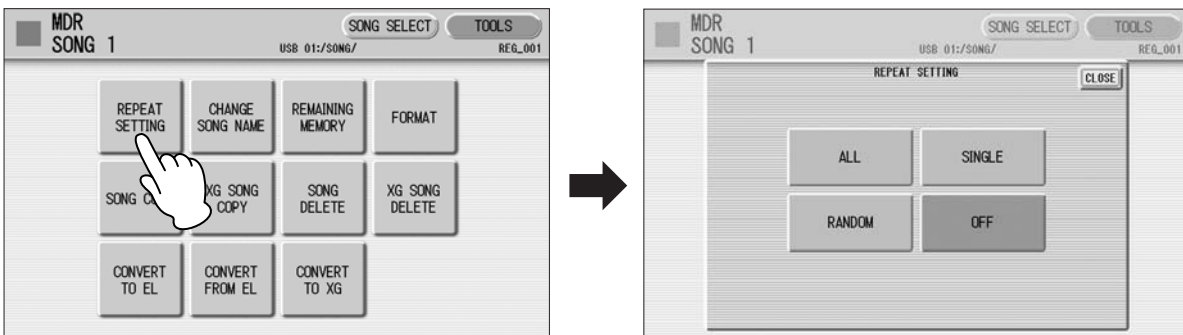

- 4 Select the repeat mode.**

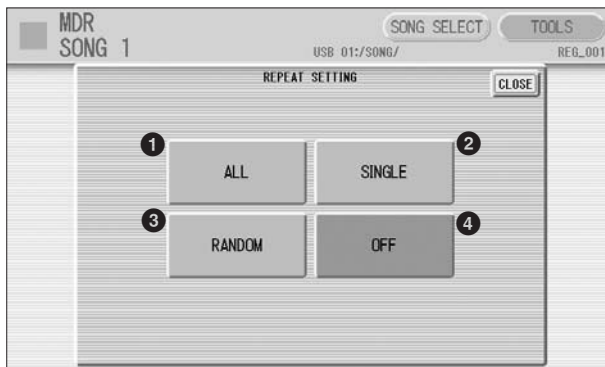

1 ALL

Repeats all songs in the currently selected folder in order.

2 SINGLE

Repeats the currently selected song again and again.

3 RANDOM

Repeats all songs in the currently selected folder randomly.

4 OFF

Cancels repeat playback.

- 5 Exit from the Repeat Setting display by pressing the [CLOSE] button at the top right of the display.
- 6 Press the [▶] (Play) button in the SONG SELECT Page to begin playback.
When you stop playback, the repeat setting is automatically cancelled.

Playing Back XG Songs



Reference Page

Converting to XG (page 132)

The DDK-7 allows you to playback XG song data, created on the computer or converted from DDK-7 song format to XG format. The fast forward, rewind and pause controls are available, just as with songs (performances) recorded on the DDK-7.

- 1 Insert the media containing XG song data into the USB TO DEVICE terminal.
- 2 Select the media that contains the desired XG song in the SONG SELECT Page.
For details on selecting media, see page 107.

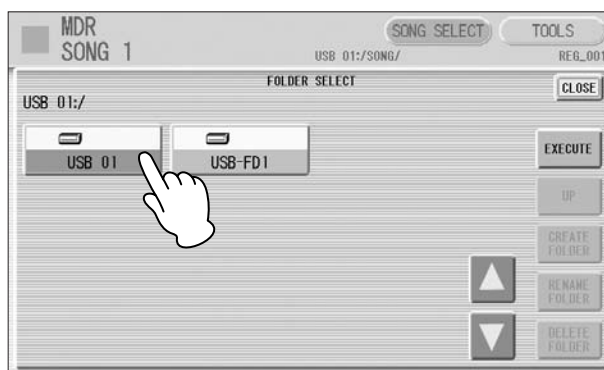

- 3 Press the [XG] button in the SONG SELECT Page to call up the XG songs in the display.

When the [ORIGINAL] button is selected, the DDK-7 songs are shown in the SONG SELECT Page; when the [XG] button is selected, the XG songs are shown.



4 Select the desired song for playback.

5 Press the [▶] (Play) button in the display to start song playback.

The following display appears, letting you set the volume or mute settings for each part.

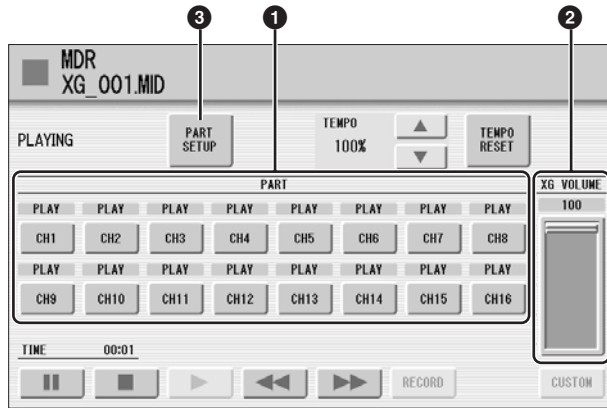

1 PART buttons

Sets the each part for playback or mute (off). Each press of the button toggles between PLAY and OFF.

2 XG VOLUME

Adjusts the volume of the XG song within a range of 0 – 100. To set the volume, touch the slider in the display directly or use the Data Control dial.

3 PART SETUP

Determines the volume balance of the parts. Pressing this button calls up the following display.

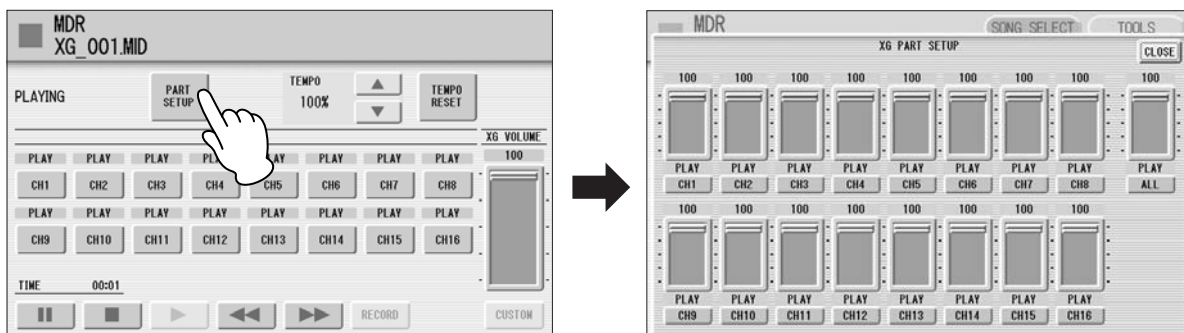

You can adjust the volume of each part within a range of 0 – 100. Use the ALL slider to adjust the volume of the XG song (the same function as XG VOLUME above). Each channel button below each slider (for example, the [CH1] button) lets you set the part to mute or play (the same function as the PART buttons above).

9 Other Functions (Tools)

The TOOLS Page in the M.D.R. display has many functions, such as song copy, song delete, etc.

Song Copy

This function lets you copy data recorded in one song to another song. You can copy and exchange the data even between two different media. (Songs created with the EL-series, such as the EL-900, cannot be copied.) Make sure to check the remaining memory of the destination media in advance. If memory space is insufficient, or if the folder already contains 100 songs, Song Copy is not available. Copying of XG songs is done with a different method from Song Copy here. Refer to “XG Song Copy,” page 133.

Moving a Protected Song

A protected song can be copied within a folder, but it cannot be copied to another folder or media. If you specify another folder or media as the copy destination, a message appears prompting moving of the song — not copying. When the [EXECUTE] button is pressed, the protected original song and all protected edited songs which come from the same protected original song will be moved together.

To copy within one media:

Insert the appropriate media.

To copy a song from one USB flash memory to another:

Insert the appropriate source and destination USB flash memory devices.

To copy between a SmartMedia card and USB flash memory:

Insert the Smartmedia card into the appropriate USB device connected to the DDK-7, as well as the USB flash memory device.

- 1 Select the song to be copied.**
For details on selecting a song, see page 104.
- 2 Press the [TOOLS] button at the top right of the display to call up the TOOLS Page.**
- 3 Press the [SONG COPY] button to call up the Song Copy display.**

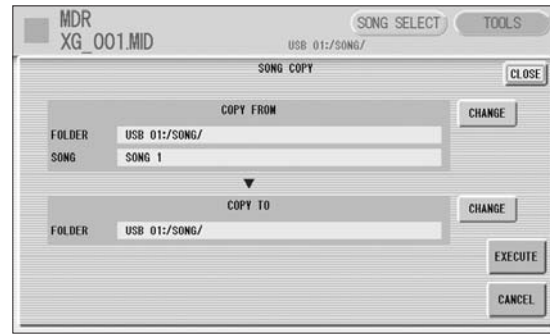
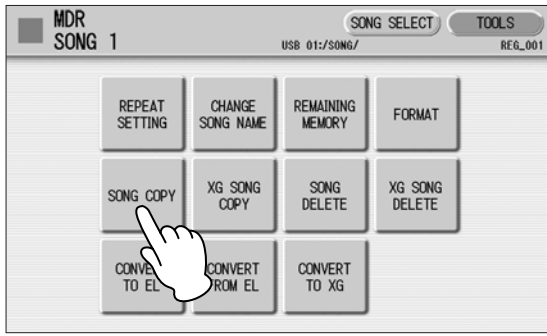

Confirm that the desired song to be copied is displayed in the upper half of the display. If you want to change the song, press the COPY FROM [CHANGE] button to call up the Song Select display and select another song.

4 Press the COPY TO [CHANGE] button to call up the Song Select display, then select the destination song.

5 Press the [EXECUTE] button to execute Song Copy.
If you have not selected a blank song, a message appears prompting confirmation whether to overwrite or not. Select [OVERWRITE] to execute or [CANCEL] to abort the operation.



Never attempt to eject the media or turn the power off during copying.

The song name of the destination is the same as the one of the source song, but “*” is attached at the beginning.

If you want to change the song name, see page 113.

Song Delete

You can delete data in one song; only Registration data, only performance data, or both of them (entire song) can be deleted. The songs created with the EL series such as EL-900 cannot be deleted.

To delete the XG song, the method is different from the song delete. Refer to “XG Song Delete,” page 134.

1 Select the song to be deleted.
For details on selecting a song, see page 104.

2 Press the [TOOLS] button at the top right of the display to call up the TOOLS Page.

3 Press the [SONG DELETE] button to call up the Song Delete display.



Confirm that the desired song to be deleted is displayed in upper half of the display. If you want to change the song, press the [CHANGE] button to call up the song select display and select the desired song.

4 Select the desired data you want to delete, “REGIST” and/or “SONG.”

When you want to delete the entire song, select both REGIST and SONG. If only “REGIST” is selected, the Registration data in the song will be deleted. If only “SONG” is selected, the performance data in the song will be deleted. If the song does not contain Registration (or performance) data, you cannot select “REGIST” (or “SONG”) in the display.

5 Press the [EXECUTE] button.

A message will appear prompting confirmation of the operation. Select [DELETE] to delete the song, or [CANCEL] to abort the operation.

About Protected Songs

If you buy or download the song data, it may be protected so that you cannot delete or copy, in order to prevent accidental erasure or protect copyright. This is “Protected Song.” Protected songs can be saved to a USB flash memory.

The protected song can be played back as same as the song you created, but it cannot be converted to XG format, or EL format. It is not possible to edit the Registration data in the protected song, nor to overwrite the performance data.

If you want to edit the protected song, first copy it within one media/folder, then edit the copy. (You cannot copy to another media/folder.) The copy song (called “protected edit song”) is available only when the original song (called “protected original song”) exists in the same folder. Be careful not to delete the protected original song.

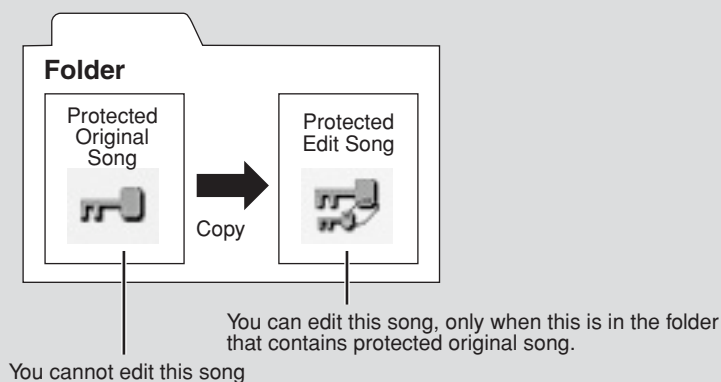

To move the protected song in a USB flash memory with a computer, you'll need to use the Musicsoft Downloader application. If you move the song without Musicsoft Downloader, the song cannot be played back.

Musicsoft Downloader can be obtained at the following Internet address:

<http://music.yamaha.com/download/>

Converting to XG

This function allows you to convert the DDK-7 song data to XG format data. You can playback the data using XG devices. The converted XG song data may sound differently from the original data.

Confirm that the media should contain enough amount of available memory before the conversion. The protected songs cannot be converted to XG format.

1 Selects a song to be converted to XG.

For details on selecting a song, see page 104.

2 Press the [TOOLS] button at the top right of the display to call up the TOOLS Page.

3 Press the [CONVERT TO XG] button.

A message will appear, prompting confirmation of the converted data.

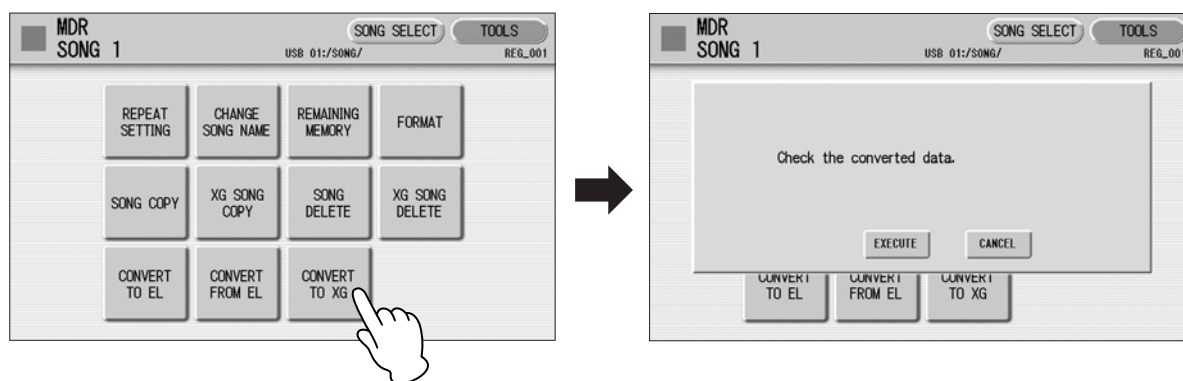

4 Press the [EXECUTE] to convert.

The M.D.R. starts playback of the selected song for you to decide whether you convert it to the XG data, or not. After finishing playback the following message appears.

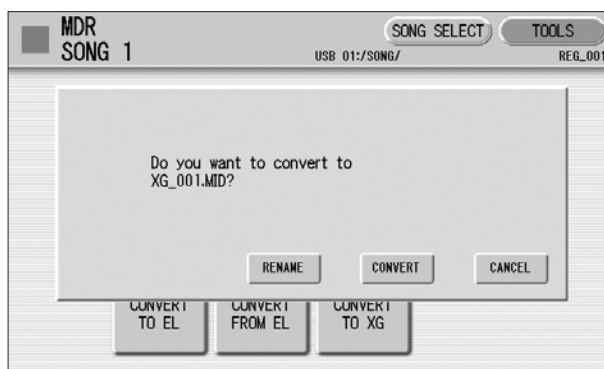

5 (If necessary) Press the [RENAME] to give a name to the converted XG song.

For details of the method to edit the song name, see page 113.

6 Press the [CONVERT] button.

After the process of the conversion the LCD returns to the original display.

To call up the XG song in the display, press [XG] button in the SONG SELECT Page of the M.D.R. display. For more information, see page 126.

XG Song Copy

1 Select the XG song to be copied.

For details to select an XG song, see page 126.

2 Press the [TOOLS] button at the top right of the display to call up the TOOLS Page.

3 Press the [XG SONG COPY] button to call up the XG Song Copy display.



Confirm that the desired song to be copied is displayed in upper half of the display. If you want to change the song, press the COPY FROM [CHANGE] button to call up the Song Select display and select the desired song.

4 Press the COPY TO [CHANGE] button to call up the folder select display, then select the destination media.

5 Press the [EXECUTE] button to execute the XG Song Copy. Select [CANCEL] or [CLOSE] to abort the operation.

If the remaining memory of the destination media is insufficient, XG Song Copy cannot be executed. (An error message will appear and the operation is cancelled.) Up to 120 XG songs can be saved in one folder.

XG Song Delete

- 1 Select the XG song to be deleted.**
For details on selecting an XG song, see page 126.
- 2 Press the [TOOLS] button at the top right of the display to call up the TOOLS Page, then select the [XG SONG DELETE] button.**
The XG Song Delete display appears.

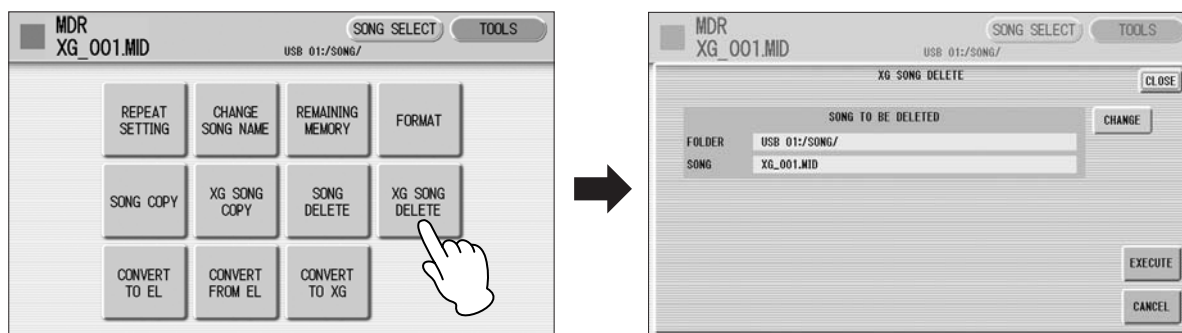

- 3 Confirm that the desired song to be deleted is shown in the upper half of the display, then press the [EXECUTE].**
If you want to change the song, press the [CHANGE] button to call up the Song Select display and select the desired song. After pressing the [EXECUTE] button, a message appears prompting confirmation of the operation. Select [DELETE] to delete the selected XG song, or select [CANCEL] to abort the operation.

Converting to EL format



Reference Pages

About Protected Songs
(page 131)



NOTE

User rhythms cannot be converted to EL format.

- 1 Select the song to be converted to EL-series format.**
For details on selecting a song, see page 104.
- 2 In the TOOLS Page, press the [CONVERT TO EL] button to call up the Convert display.**

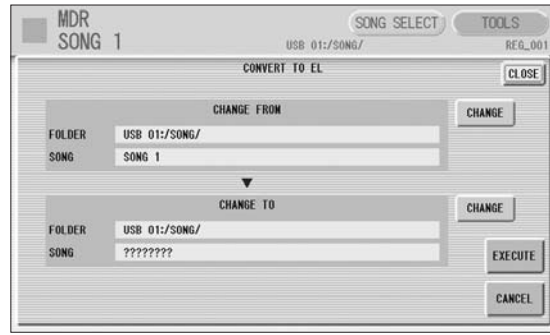
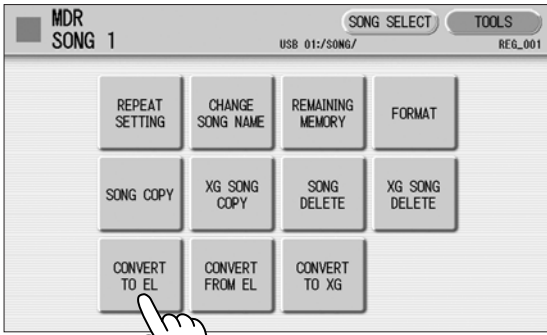

Confirm that the desired song to be converted is displayed in the upper half of the display. If you want to change the song, press the [CHANGE] button of the Change From section to call up the Song Select display and select the desired song.



NOTE

If the source song's name contains full size characters or Japanese characters, the converted song name will be shown with question marks (such as "????").

3 Press the [CHANGE] button of the Change To section in the display, then select the destination.

If the source song contains two or more Registration banks, you'll need to make ready the same number of destination songs to save the converted data.

4 Press the [EXECUTE] button in the display to start conversion.

A message appears, prompting confirmation of the operation. Select [CONVERT] to convert to EL format, or [CANCEL] to abort the operation. If the remaining memory of the floppy disk is insufficient, conversion cannot be executed. (An error message appears and the operation is cancelled.)

Converting from EL format

You can convert the songs in the floppy disk created with an EL-series Electone, such as the EL-900, to the DDK-7 format, and save it to a USB flash memory. To use the floppy disk, you'll need to install the optional UD-FD01 floppy disk drive. Depending on the original song, the sound or tempo of the converted song may differ from the original data, or the Next Song function of the original song may not be effective.

1 Insert the floppy disk that contains the song you want to convert, then select the source song.

For details on selecting a song, see page 104.

2 In the TOOLS Page, press the [CONVERT FROM EL] button to call up the Convert display.



NOTE

When you convert the protected EL data to DDK-7 format, set the write-protect tab of the EL disk to the "overwrite" position (tab closed).



NOTE

When converting a protected EL song to the DDK-7 format, make sure to use a USB flash memory card with ID.

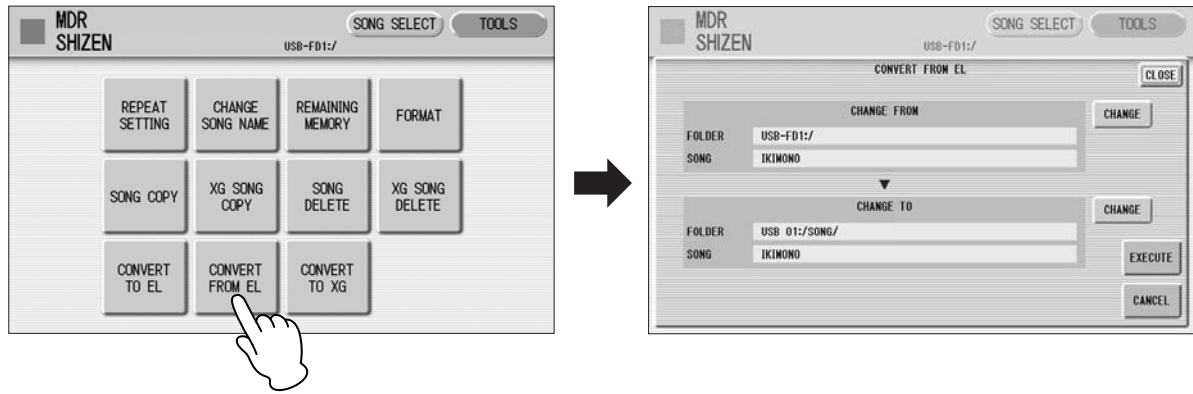

3 Confirm that the desired song to be converted is shown in upper half of the display.

If you want to change the song, press the [CHANGE] button of the Change From section to call up the Song Select display and select the desired song.

4 Press the [CHANGE] button of the Change To section in the display, then select the destination.

The specified destination location must be within the range of Song 1 - 100 in the USB flash memory. If a destination is not selected, an empty song is automatically set as the destination.

5 Press the [EXECUTE] button in the display to start conversion.

A message appears, prompting confirmation of the operation. Select [CONVERT] to convert from EL format, or [CANCEL] to abort the operation. If the remaining memory of the USB flash memory is insufficient, conversion cannot be executed. (An error message appears and the operation is cancelled.)

Checking the Remaining Memory/media ID

In the TOOLS Page, press the [REMAINING MEMORY] button. This allows you to check the remaining memory in the media, the song data capacity of the currently selected song, and whether or not the media has an ID.



8 Voice Edit

This DDK-7 has a Voice Edit feature that allows you to create your own Voices. We suggest that you read through the Voice Structure below at first to get a firmer understanding of the Voices. Then go through the editing steps, reading *Editing a Voice* on page 140 for editing of an AWM Voice.

Contents	
1 Voice Structure137	3 Saving the edited Voice 145
• AWM Voice structure137	4 Quitting Voice Edit 146
2 Editing a Voice138	5 Recalling an Edited Voice 146
• Selecting a Voice for editing.138	
• Editing an AWM Voice140	

1 Voice Structure

The internal structure of the Voices of this DDK-7 is explained below.

AWM Voice structure

AWM Voices consist of up to four recorded samples of a real instrument. Each waveform, referred to as an “Element,” can be edited, by changing the level (volume), filter settings, and so on. A single Voice contains four boxes (AWM1 – AWM4) in which the Elements are put. If a Voice consists of less than three Elements, some boxes are empty. For example, Strings 1 consists of two Elements (as shown).

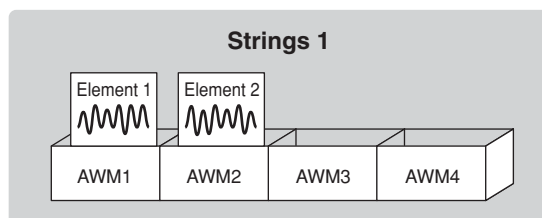

You can add Elements from other Voices – Brass, for example – if a box (AWM3 and/or AWM4) is empty. This allows you to create your own original ensemble sounds. In the Voice Edit function, you can edit not only each Element, but also assemble some Elements from other Voices.

2 Editing a Voice

Selecting a Voice for editing

- 1 Select the Voice you want to edit from the Voice Menu.**
For example, if you want to edit Accordion 1, select [Accordion 1] in the Voice Menu in any Voice section.



Mute all other Voice sections except for the targeted Voice section.

- 2 Press the [PROGRAM] button to call up the PROGRAM Display.**

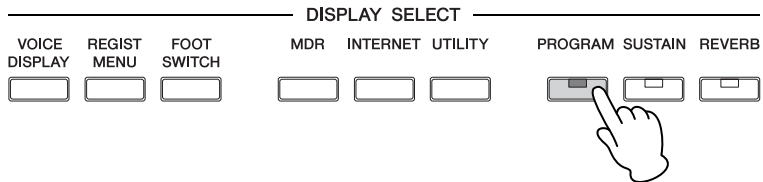

- 3 Select the desired voice section at the left half of this display.**

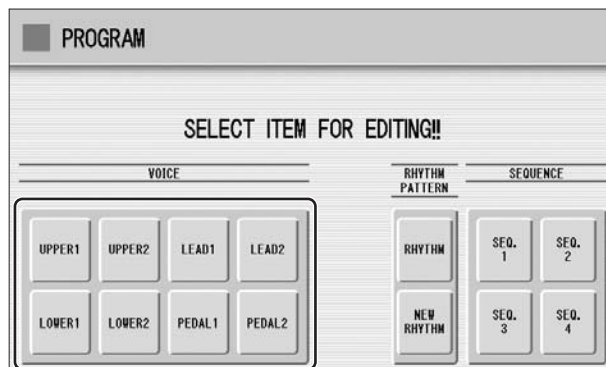

After you have selected the Voice section, the AWM Page (first page of the Voice Edit display) will appear.

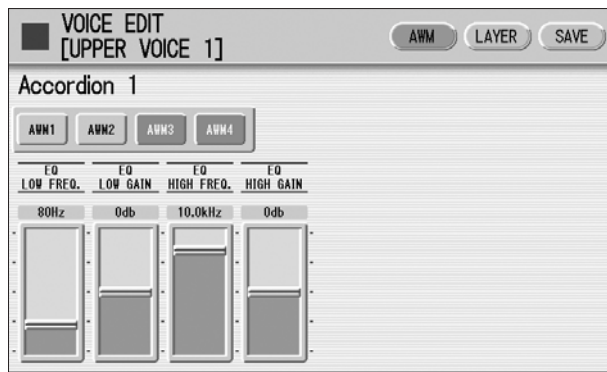

The message “Voice data is too large to edit” may appear when you press the [PROGRAM] button. If this message appears, select another Voice.

Editing an AWM Voice

You can edit an AWM Voice on the AWM Page and LAYER Page in the Voice Edit display. In the AWM Page, the tonal balance of the entire Voice can be corrected by some EQ parameters. In the LAYER Page, you can make detailed edits to each Element.

AWM Page

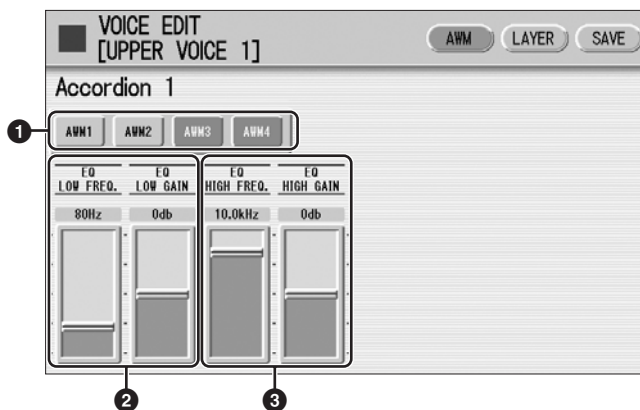

1 Element On/Off switches

The [AWM1] – [AWM4] buttons indicate the Elements which make up the selected Voice. You can mute any of the Elements by simply pressing the corresponding button. Pressing the button again cancels the mute.

2 EQ LOW FREQ./EQ LOW GAIN

Sets the frequency and gain (level) of the low frequency band. The EQ LOW FREQ. slider sets the desired frequency band over a range of 32 Hz – 2.0 kHz. The EQ LOW GAIN slider sets the level for the frequency band (specified by the EQ LOW FREQ. slider) over a range of -12 dB – +12 dB.

3 EQ HIGH FREQ./EQ HIGH GAIN

Sets the frequency and gain (level) of the high frequency band. The EQ HIGH FREQ. slider sets the desired frequency band over a range of 500 Hz – 16.0 kHz. The EQ HIGH GAIN slider sets the level for the frequency band (specified by the EQ HIGH FREQ. slider) over a range of -12 dB – +12 dB.

EQ (Equalizer)

Usually an equalizer is used to correct the sound output from amps or speakers to match the special character of the room. The sound is divided into several frequency bands, then by raising or lowering the level for each band, the correction is made. This DDK-7 has a two-band (high and low) digital equalizer that lets you adjust the overall sound according to the type of music you play — classical music being more refined and soft, pop music more crisp, and rock music more dynamic.

LAYER Page

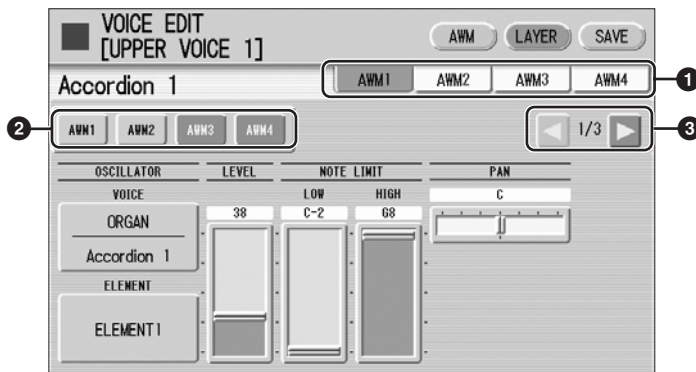

1 Element select buttons

Select the Element you wish to edit.

2 Element On/Off switches

The [AWM1] – [AWM4] buttons indicate the Elements which make up the selected Voice. You can mute any of the Elements by simply pressing the corresponding button. Pressing the button again cancels the mute. Muting all other Elements except for the one you are editing lets you clearly hear that single Element for ease in editing. Note that when some Elements are muted, playing the keyboard in certain key areas or with certain velocities may result in no sound.

3 Display switch buttons

The LAYER Page contains three pages. The ◀ ▶ buttons are used to switch among them.

LAYER Page 1

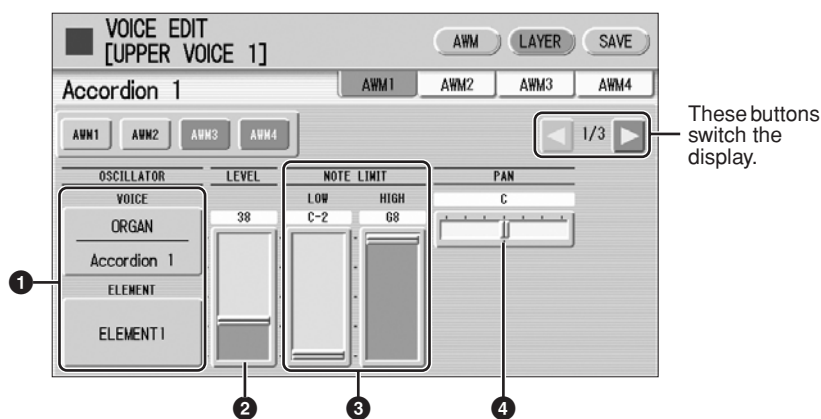

1 VOICE/ELEMENT

Indicates the Voice/Element currently being edited. For example, the screen above shows that Element 1 of Accordion 1 is being edited.

You can also call up another Element from another Voice and replace the currently selected Element with it. Pressing the VOICE or ELEMENT button in the display calls up the Voice or Element menu, from which you can select the desired Voice/Element.

2 LEVEL

Determines the output level of the Element.

Range: 0 – 127

3 NOTE LIMIT

Determines the lowest and highest notes in the range for which the Element sounds. The setting of the HIGH slider cannot be set lower than that of the LOW slider. Some Elements are not affected by this parameter.

Range: C-2 – G8

4 PAN

Determines the position of the Element in the stereo image.

Range: L64 – R63

LAYER Page 2

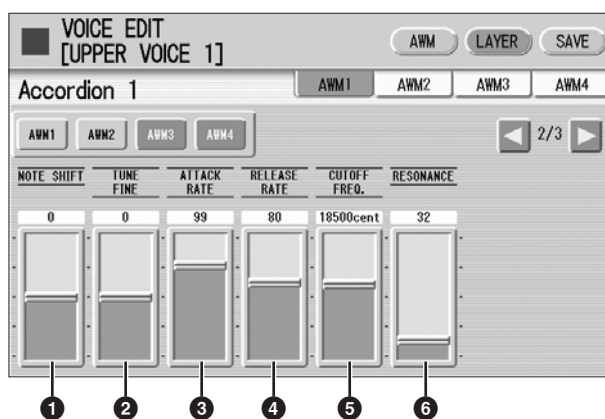

1 NOTE SHIFT

Determines the pitch settings in semitones.

Range: -64 – +63

2 TUNE FINE

Determines the fine tuning.

Range: -64 – +63

3 ATTACK RATE

Determines how quickly the Element will reach its maximum level after the key is played. Higher values produce a faster attack.

Range: 0 – 127

4 RELEASE RATE

Determines how much time it takes for the level to reach 0 after the key is released. Higher values make the time shorter.

Range: 1 – 127

5 CUTOFF FREQ.

Determines the cutoff frequency of the filter.

Range: 9600 – 24000 cent

6 RESONANCE

Determines the amount of resonance (harmonic emphasis) applied to the signal at the cutoff frequency. Some Elements are not affected by this parameter.

Range: 16 – 140

Filter — Cutoff frequency and Resonance

Filter modifies the tone by cutting the output of a specific frequency portion of the sound. This DDK-7 is equipped with a low pass filter, which passes only those signals below the cutoff frequency and cuts signals above the cutoff frequency.

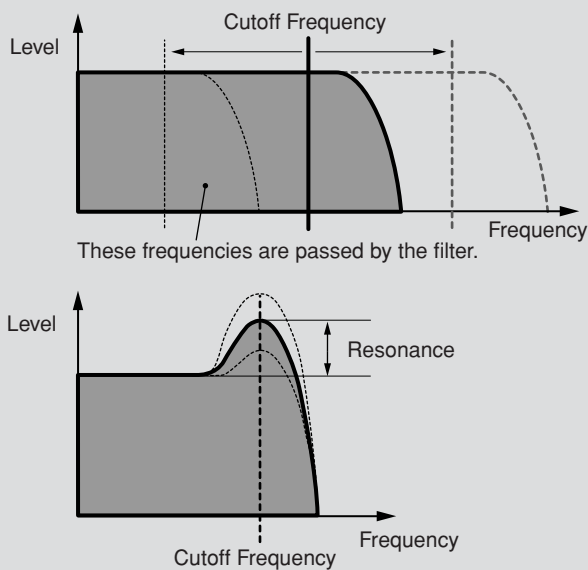

You can produce a relatively bright or darker sound by setting the cutoff frequency. Resonance is a parameter that boosts the level of the signal in the area of the cutoff frequency. By emphasizing the overtones in this area, this can produce a distinctive “peaky” tone.

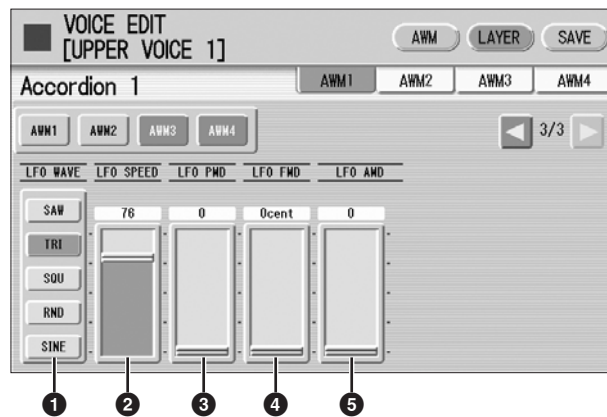

1 LFO WAVE

Determines the LFO waveform used to vary the sound. For details, see page 145.

2 LFO SPEED

Determines the speed of the LFO waveform. Higher values make the speed faster.

Range: 2 – 93

3 LFO PMD (Pitch Modulation Depth)

Determines the amount by which the LFO waveform varies the pitch of the sound. Higher values result in a greater amount of pitch change. For the minimum setting, the pitch does not change.

Range: 0 – 400

4 LFO FMD (Frequency Modulation Depth)

Determines the amount by which the LFO waveform varies the filter cutoff frequency. Higher values result in a greater amount of frequency change. For the minimum setting, the frequency does not change.

Range: 0 – 4800 cent

5 LFO AMD (Amplitude Modulation Depth)

Determines the amount by which the LFO waveform varies the amplitude of the sound. Higher values result in a greater amount of amplitude change. For the minimum setting, the amplitude does not change.

Range: 0 – 128



Reference Page

Vibrato (page 43)

When playing a User Voice you have created using the LFO parameters (above), set the Vibrato setting in the Voice Condition display to “Preset,” not “User.” If Vibrato is set to “User” and the Vibrato parameters (depth and/or speed) are set fairly high, you may not be able to hear the effect of the LFO.

LFO (Low Frequency Oscillator)

As its name suggests, the LFO creates waveforms of a low frequency. These waveforms can be used to vary the pitch, filter or amplitude to create effects such as vibrato, wah and tremolo.

The following five waveforms are available.

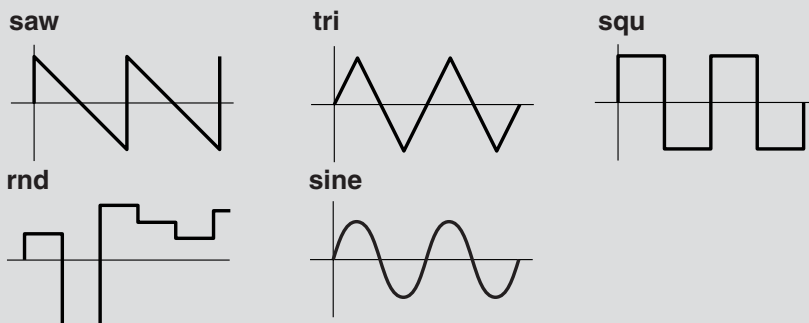

3 Saving the edited Voice

Edited AWM Voices can be saved as User Voices (up to sixteen).

- 1 Press the **[SAVE]** button at the top right of the display to call up the **SAVE Page**.



- 2 Select the **User Voice** number you wish to save to.

The message appears to prompt confirmation of the operation. (Saving a new Voice automatically erases the Voice previously stored to the selected User number.)

- 3 (If necessary) Press the **[RENAME]** button to give a name to your original Voice.

The method for editing the name is the same as the one for the song name in the M.D.R. section. (See page 113 for more information.) Up to sixteen characters can be entered.

- 4 Press the [SAVE] button to save the Voice, or press [CANCEL] to abort the operation.



This operation automatically erases any Voice that had been previously saved to the selected User Voice number. Be careful not to erase any important data. Always save your important data in advance to a USB flash memory or other external media using the M.D.R. function.

After saving the Voice, be sure to quit the Voice Edit function (page 146) before turning the power off. Turning off the DDK-7 without quitting Voice Edit erases the User Voice you have edited.

4 Quitting Voice Edit

You can quit the Voice Edit function from any of its display pages.

1

Press the [PROGRAM] button on the panel.

If your original Voice has already been saved, the Voice Edit function quits automatically. If the edited Voice has not been saved, a message appears prompting confirmation of the operation.

2

Select [EXIT] to quit the Voice Edit function, or [CANCEL] to abort the operation and return to the previous display.



When quitting Voice Edit, the square at the top left of the display turns light blue for a few seconds, indicating that the Voice you have created is currently being saved. Do not turn the power off while the Voice is being saved.

5 Recalling an Edited Voice

Once your original AWM Voice has been saved, it can be selected from the User menu in each Voice section. Refer to chapter 2, “Selecting Voices with the Voice buttons” (page 26).



The DDK-7 includes powerful rhythm programming functions: Rhythm Pattern Program and Rhythm Sequence Program. Rhythm Pattern Program allows you to record your own original rhythms and save them as user rhythms. Rhythm Sequence Program lets you connect the existing rhythms or your original rhythms to create complete rhythm tracks, which you can automatically play back during your performance. Moreover, Rhythm Sequence Program includes an automatic Registration Shift feature — called Registration Sequence.

Contents

<p>1 Outline of the Rhythm Programming Operation . 147</p> <p>2 Rhythm Pattern Program 148</p> <ul style="list-style-type: none"> • Entering the Rhythm Pattern Program 148 • Basic settings for the Rhythm Pattern 151 • Entering Percussion Sounds to a Rhythm Pattern – Step Write 154 • Editing Entered Percussion Notes 157 • Entering Percussion Sounds to a Rhythm Pattern – Real Time Write 162 • Creating Backing Patterns (Rhythmic Chord Function) 163 • Changing the Voices for Accompaniment Parts . . . 166 • Adjusting Volume and Panning. 167 • Effect Settings. 168 • Detailed settings for each percussion instrument . 171 • Saving Rhythm Patterns 172 	<ul style="list-style-type: none"> • Quitting the Rhythm Pattern Program 174 • Recalling User Rhythm Patterns 174 • Selecting Rhythm from an External Media 175 • Percussion Kit List 176 <p>3 Rhythm Sequence Program 183</p> <ul style="list-style-type: none"> • Selecting a Sequence. 183 • Programming a Sequence 185 • Auditioning a Sequence 186 • Editing an Existing Rhythm Sequence 186 • Programming a Registration Sequence 188 • Editing an Existing Registration Sequence. 189 • Quitting the Rhythm Sequence Program 190 • Playing Rhythm Sequences 191 • Playing All Sequences in Order 191 <p>4 Saving Rhythm Pattern and Rhythm Sequence Data to external media 192</p>
---	--

1 Outline of the Rhythm Programming Operation

Rhythm Pattern Program (pages 148 – 173)

You can create your original rhythm patterns by entering percussion sounds or editing preset rhythm patterns.

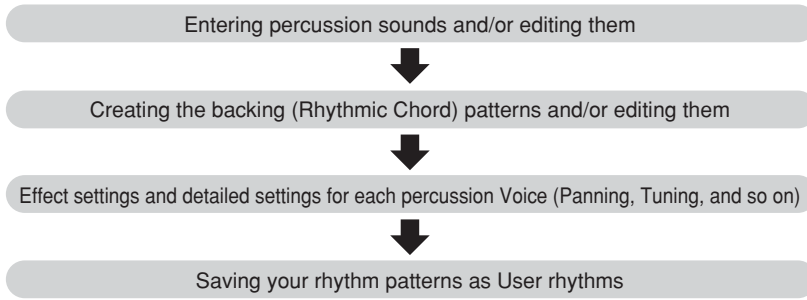

Rhythm Sequence Program (pages 183 – 190)

You can connect any of the rhythms together to make complete rhythm compositions. Moreover, you can also program Registration Shift events at any point in the composition so that the Registration Memory settings automatically change as the rhythm sequence plays back.

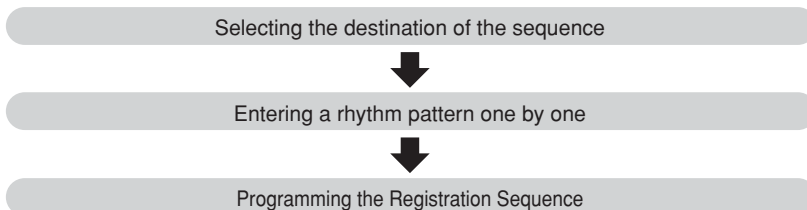

2 Rhythm Pattern Program

Rhythm Pattern Program lets you use any of the different instrument sounds (drum and percussion) assigned to each key on the Upper and Lower keyboards in creating your own rhythms. Up to 48 of your original rhythms can be saved as User Rhythms.

Entering the Rhythm Pattern Program

There are two ways to program a User pattern: copying a preset rhythm that is similar to the rhythm you want to create, and creating your own rhythm from scratch.

To copy a preset rhythm:

Copying a preset rhythm lets you make changes to an existing rhythm, saving you time if you want to program a rhythm that is similar to an existing preset pattern.

To create your own rhythm from scratch:

Load a blank pattern to the Rhythm Pattern Program, then create a completely new rhythm.

1 To copy a preset rhythm, select the rhythm you want to copy from the Rhythm Menu.



NOTE

Pressing the [PROGRAM] button while the rhythm is running automatically stops the rhythm.

2 Press the [PROGRAM] button to call up the Program Display.

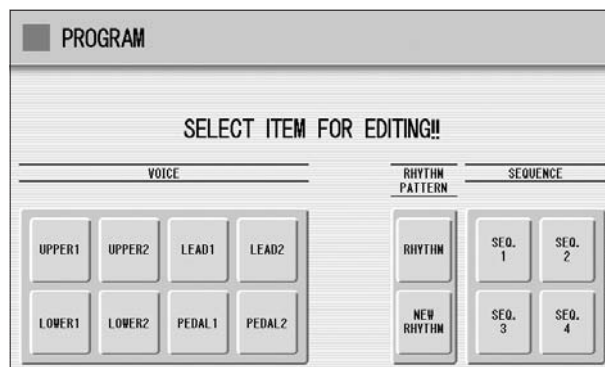
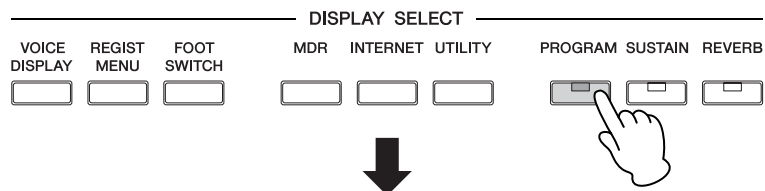

- 3** To copy a preset rhythm, press the [RHYTHM] button. To create your own rhythm from scratch, press the [NEW RHYTHM] button.

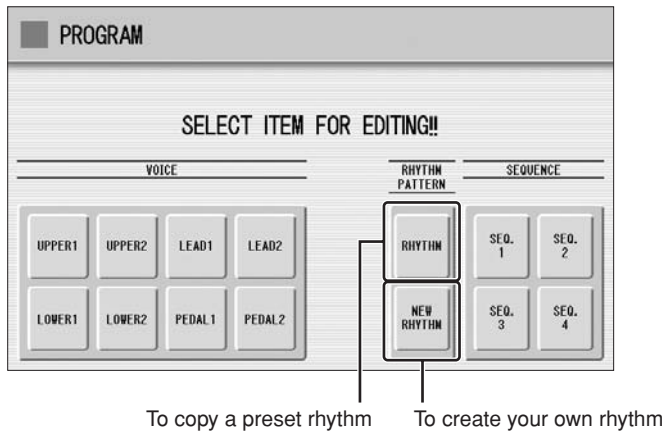

A Rhythm consists of 15 sections: Intro 1 – 3, Main A – D, Fill In A – D, Ending 1 – 3, and Break. In Rhythm Pattern Program, you can enter or edit percussion notes one by one, or assemble each part from other different rhythms to create your own new User Rhythm.

Case 1: Creating your own rhythm by changing a preset rhythm

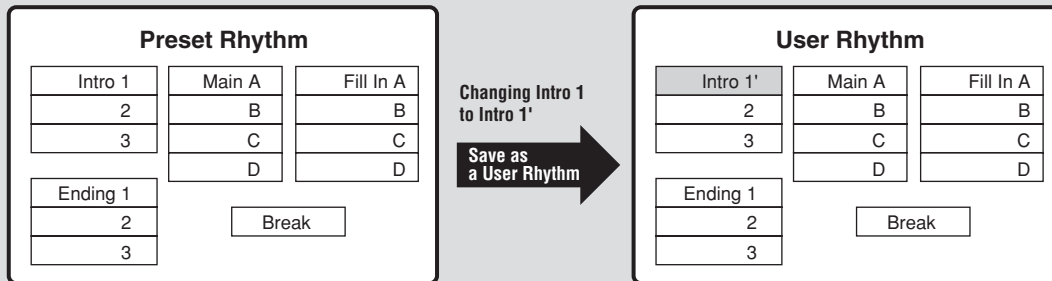

All Rhythm sections, including any which have not been edited, are saved as one User Rhythm.

Case 2: Creating your own rhythm by assembling parts from other different rhythms

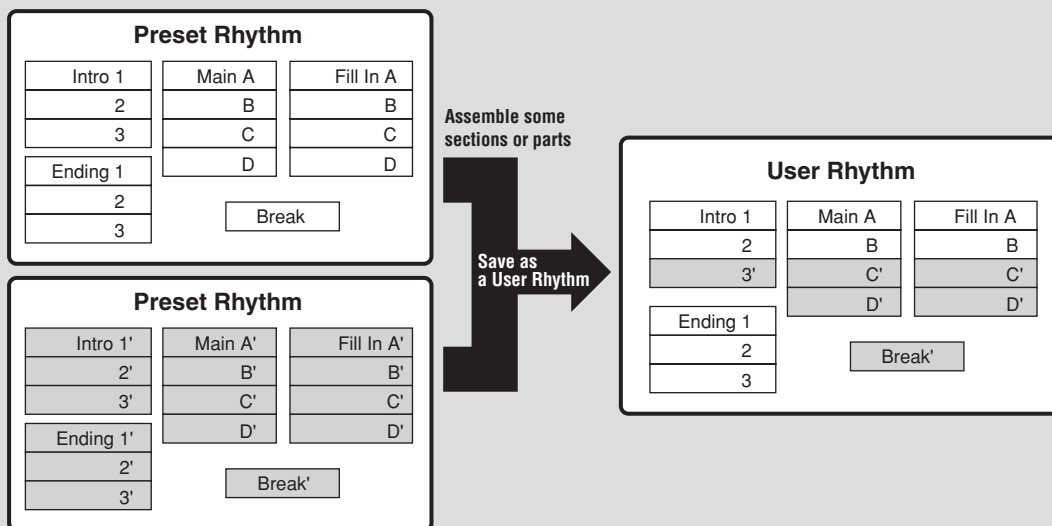

Case 3: Creating your own rhythm from scratch

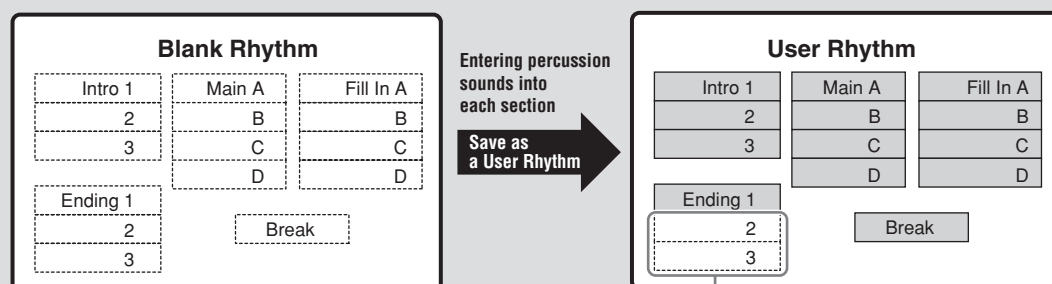

These are blank sections (no percussion sounds); if you press ENDING [2] or [3] button, no sound is played.

Basic settings for the Rhythm Pattern

In the SETTING Page of the display, set the conditions of the rhythm, such as time signature, measure length, and so on. You can also customize the part settings in this SETTING Page — deleting any part or copying a part from another rhythm to the currently selected rhythm.

- 1 Press the [SETTING] button in the display to call up the SETTING Page.

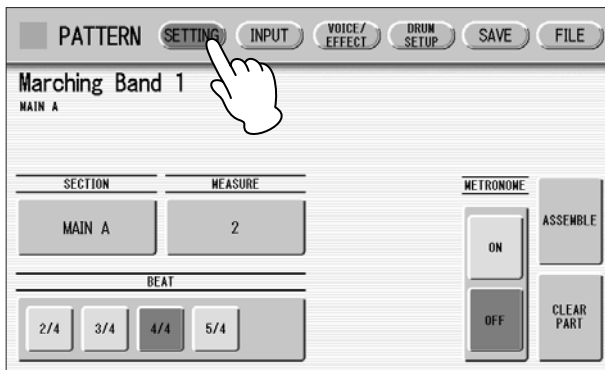

- 2 Determines the time signature used for the rhythm. You can select the time signature with the BEAT buttons.

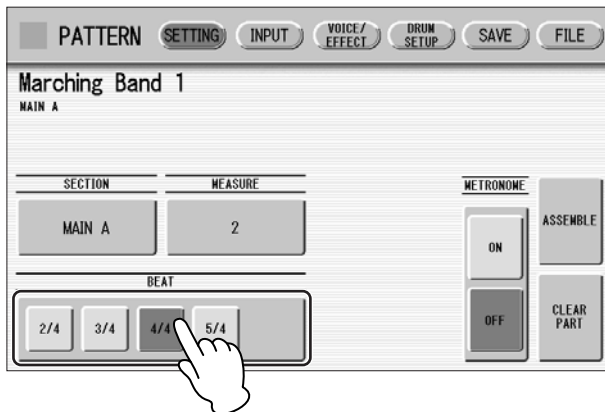

If you start the Rhythm Pattern Program from a preset rhythm, pressing a BEAT button that is not the same as the currently selected rhythm calls up the following message.

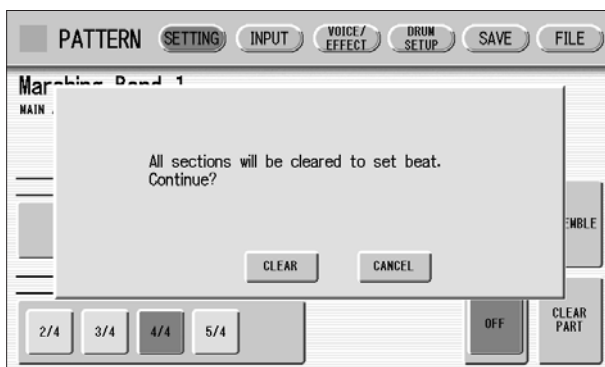

Selecting [CLEAR] deletes all data in the rhythm and changes the time signature. Select [CANCEL] to abort the operation.

3 Select a section to which you want to enter or edit the rhythm pattern.

Pressing the SECTION button on the display calls up the Section Select pop-up menu. After selecting the desired section, the pop-up menu automatically closes.

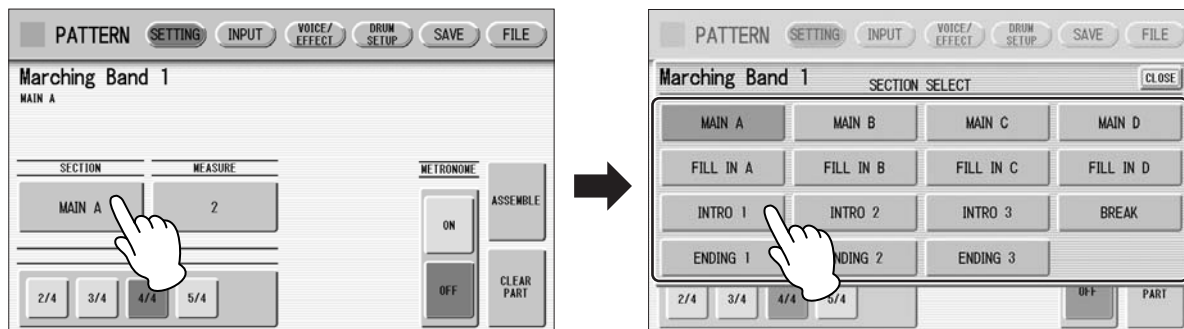

You can play the selected section by pressing the Rhythm [START] button on the panel. You can also change the section while the rhythm is playing. For details on muting the accompaniment part, refer to page 167.

4 Sets the measure length of the rhythm pattern.

Pressing the MEASURE button on the display calls up the Measure Select pop-up menu. Select the desired measure in the pop-up menu. If you select Break or Fill In as the section, the measure cannot be changed.

5 (If necessary) Set the Metronome, Part Assemble, and Part Clear parameters.

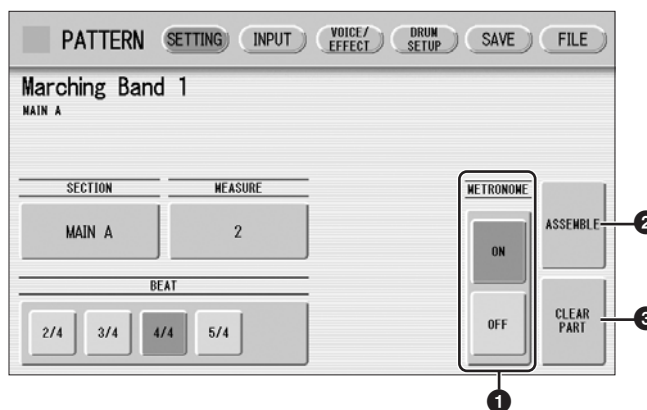

1 METRONOME

Turns the metronome click on or off. When set to ON, the metronome sounds on each beat of the measure (for example, three times per measure in 3/4 time) to serve as a rhythmic guide when programming patterns. Set to On here with Real Time Write.



Reference Pages

Step Write and Real Time Write (page 154)

Entering Percussion Sounds to a Rhythm Pattern – Real Time Write (page 162)

2 ASSEMBLE

Copies the part from another rhythm to the currently selected rhythm. You can assemble various sections from multiple rhythms to create your original rhythm. Pressing the [ASSEMBLE] button calls up the following display.

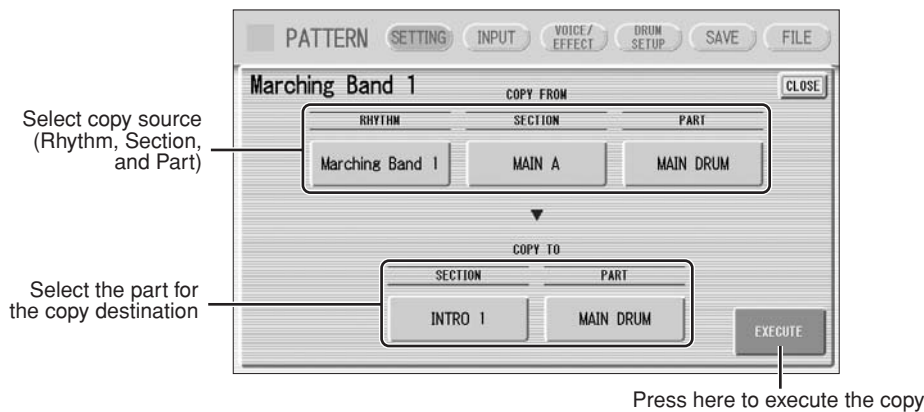

Select the copy source: Rhythm, Section and Part. Then select the destination. You can copy only one part, or all parts of a rhythm.

After setting the source and destination, press [EXECUTE]. Copy is executed and returning to the previous display.

3 CLEAR PART

Clears a specific part or parts from the currently selected rhythm. Pressing this button calls up the following display.



Select the part you want to delete from the displayed parts. You cannot select a part that contains no data (the button is grayed out). If you select [ALL] here, the percussion and all accompaniment parts are cleared.

When selecting the desired part, a display prompting confirmation of the operation appears. Select [CLEAR] to execute the operation, or select [CANCEL] to abort the operation.



Reference Page

Accompaniment (page 70)



NOTE

If you select BASS here, the bass phrase in the A.B.C. will be cleared.

**NOTE**

The volume of the percussion and accompaniment sound during use of Rhythm Pattern Program can be controlled with the VOLUME button of the RHYTHM section. When you quit Rhythm Pattern Program, the VOLUME of the RHYTHM section will return to the previous selected level.

Step Write and Real Time Write

There are two different methods you can use to program rhythms: Step Write and Real Time Write.

Step Write allows you to enter percussion sounds as individual note values. As a method, it is very similar to writing down the notes on a sheet of music paper; each note is entered one at a time, and though you can hear each individual note entered, you cannot actually hear the pattern playing as you create it. Step Write is good for precision and for entering percussion sounds whose note placement and rhythmic value has been determined, such as a bass drum that plays every beat in a measure.

Real Time Write on the other hand, is similar to using a multi-track tape recorder; you can hear previously recorded parts of the pattern as you record new parts on top. Real Time Write is best for capturing the “feel” of a rhythm, because it allows you to actually play the pattern as you are creating it.

Each method has its own advantages and uses. Which method you use depends partly on the type of rhythm you intend to create and partly on your own personal preference. You can switch between the two methods in editing to create a single rhythm by the use of both methods. This would come handy, for example, in programming the basic beats of a rhythm with Step Write, then using Real Time Write to add percussion accents and embellishments.

Which mode of the operation is selected depends on the play status of the rhythm. If the rhythm is stopped, Step Write is automatically selected. If the rhythm is playing, Real Time Write is selected. See the instructions below for Step Write, and page 162 for Real Time Write.

Entering Percussion Sounds to a Rhythm Pattern – Step Write

You can enter percussion sounds in the INPUT Page of the display. Before entering percussion sounds, turn off the Upper and Lower keyboard Voices by setting each Voice’s volume to MIN.

- 1 Press the [INPUT] button at the top of the display to call up the INPUT Page.
- 2 Select the part, MAIN DRUM or ADD DRUM, to which you want to enter the percussion.

In general, main (or basic) drum/percussion instruments (such as Bass Drum, Snare Drum, and so on) are entered in Main Drum part and others (such as Tambourine, Triangle) are entered in Add Drum part.



3 Select the desired Drum Kit.

You can select a kit from 20 Drum kits and 5 SFX kits. For details on each kit, see page 176. Pressing the button indicating the currently selected kit calls up the kit Select the pop-up menu, then select the desired kit from the pop-up menu. The selected kit is called up on the Upper and Lower keyboards.

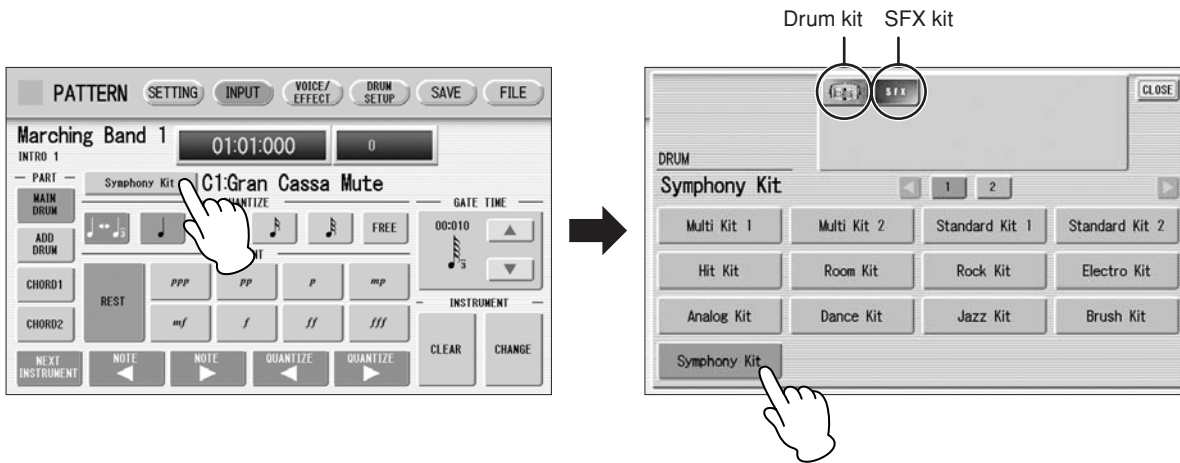

You can select only one kit for each part (Main Drum or Add Drum). When you want to create a rhythm pattern including two different drum kits, select one kit for Main Drum and another for Add Drum.

4 Select the percussion sound you wish to enter by pressing the key on the Upper or Lower keyboard that corresponds to the sound.

The selected instrument's name appears on the display.

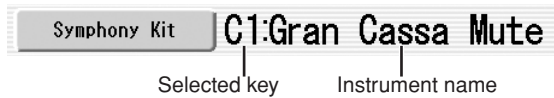

5 Set the appropriate Quantize value.

For details on Quantize, refer to page 161.



NOTE

The Quantize setting can be changed in the middle of Step Write.

6 Set the Gate Time. (This is optional, and only necessary when you want to enter a sustaining sound, such as a whistle.)

For a list of instruments that require a Gate Time setting, refer to the Percussion Kit List on page 176. For details on Gate Time, refer to page 165.

7 Use the ACCENT buttons to enter the sound to the selected point. Press each ACCENT button to actually enter the percussion sounds.

You can change the rhythm clock to which the percussion sound is entered by pressing the QUANTIZE [◀] [▶] buttons.

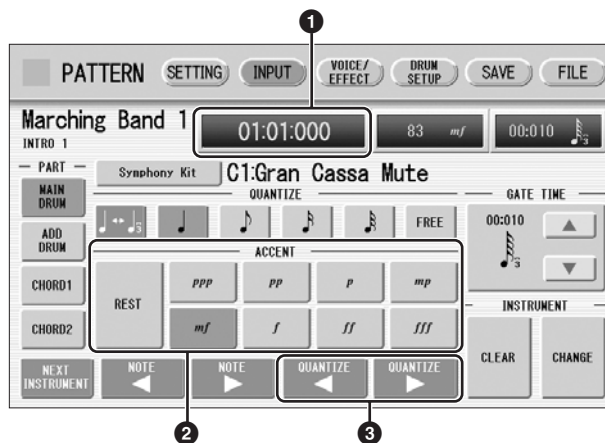

Reference Page

Basic settings for the Rhythm Pattern (page 151)

1 Rhythm Clock box

Displays the current position in the pattern according to measure, beat, and number of clicks.

A click is the smallest division of a pattern, and one beat is made up of 480 clicks.

The rhythm clock advances up to the measures set in the SETTING Page and loops back to the beginning of the rhythm (01:01:00).

2 ACCENT buttons

Records the instrument and determines its volume or Accent level. Press one of the ACCENT buttons you wish to set (“ppp” is softer and “fff” is louder; “REST” is no sound). The instrument is automatically inserted at the Accent level to the selected position in the pattern. Selection of an Accent level automatically advances the rhythm clock by one step, according to the current Quantize resolution value.

3 QUANTIZE [◀] [▶] controls

Each press of the buttons advances or reverses the rhythm clock by one step. The size of a single step is determined by the Quantize value.

8 Repeat steps #4 through #7 above to layer each instrument and complete your own rhythm.

Editing Entered Percussion Notes

You can change the accent level, position, or gate time of the entered sound, or delete the entered sound.

To change the accent level of an entered note:

- 1 Select the desired note for changing the accent level.

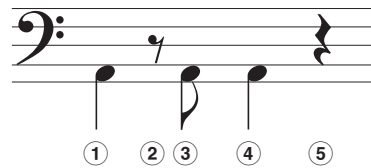
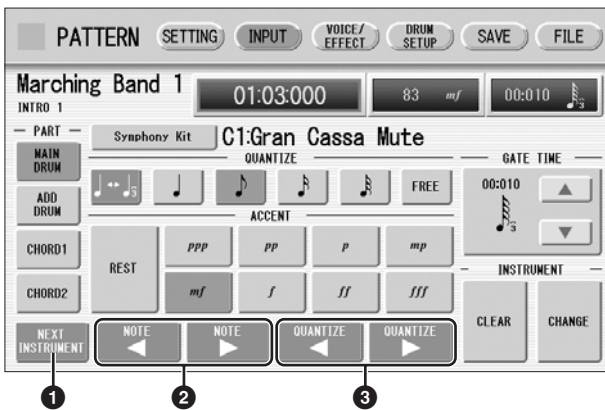

1 NEXT INSTRUMENT

Selects the entered instruments one by one, from left key to right.

2 NOTE [◀] [▶] controls

Selects the previous/next position's note of the currently selected instrument. In the above notes for example, you can select notes ①, ③ and ④ one by one. Rests ② and ⑤ are ignored.

3 QUANTIZE [◀] [▶] controls

Advances or reverses the rhythm clock by one step. The size of a single step is determined by the Quantize value.

2 Change the accent level by using the ACCENT buttons or Accent box.

The Accent box allows for finer changes.

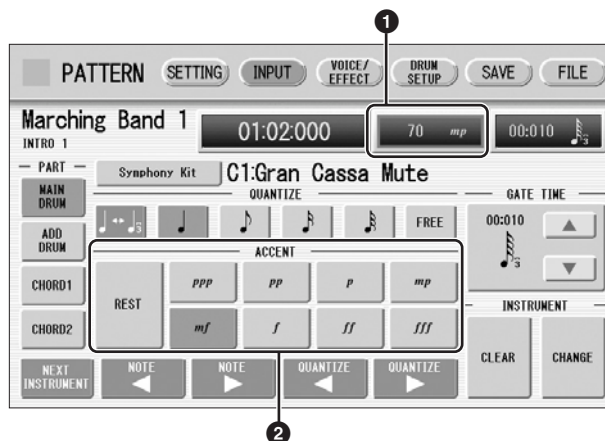

1 Accent box

Touch on the box to enable the Accent box.

Turning the Data Control dial changes the accent level over a range of 0 – 127.

The minimum setting results in no sound.

2 ACCENT buttons

Determines the coarse accent level. Eight accent levels (from “ppp” to “fff”) are available.

Press the desired Accent button to change the currently selected note to the selected level.

To move an entered note:

1 Select the note you want to move (as in Step 1 on page 157).

2 Press the Rhythm Clock box to enable the box.



3 Turn the Data Control dial to change the position by one clock.

To change the length of an entered note:

The length of sustaining sounds such as Snare Roll and Whistle can be changed by adjusting the Gate Time. See page 166 for more information.

To erase an entered note:

- 1 Select the note you want to erase (as in Step 1 on page 157).
- 2 Press the [REST] button in the ACCENT section of the display.
The selected note is deleted and replaced with a rest.



You can also erase all notes of a single instrument, or all notes entered.

To erase one instrument:

- 1 Select the key to which the instrument that you want to erase is assigned.
The key name you have selected and its instrument name are displayed.



- 2 Press [CLEAR] in the display.
The following display appears, prompting confirmation of the operation.

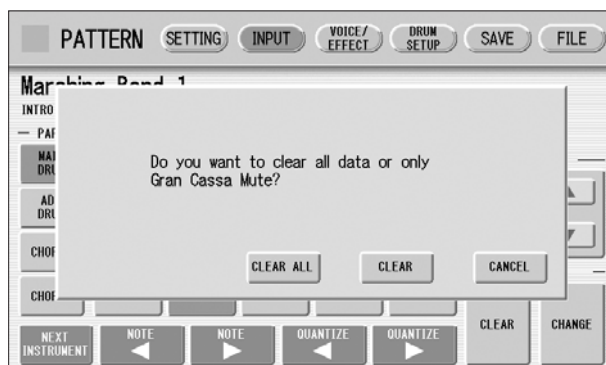

3 Select [CLEAR] to erase the selected instrument.

A bell sound indicates that the instrument has been erased.

The following method can also be used to erase one instrument.

While holding down the [CLEAR] button, press the key on the keyboard corresponding to the instrument you wish to erase.

A bell sound indicates that the instrument has been erased.

To erase all instruments:

1 Press [CLEAR] in the display.

The following display appears, prompting confirmation of the operation.

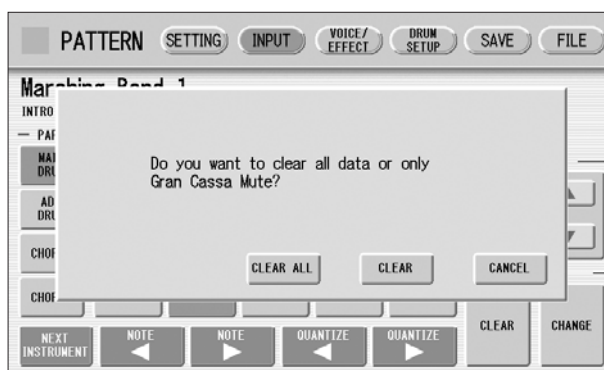

2 Select [CLEAR ALL] to erase all instruments.

All instruments are instantly erased.

When you want to replace the instrument you have already entered with another instrument, it's not necessary to delete and re-enter. You can quickly replace the sound with the following procedure.

To replace the instrument:

Before the operation, stop the rhythm.

1 Select the key to which the instrument you want to replace is assigned.

The key name you have selected and its instrument name are displayed.

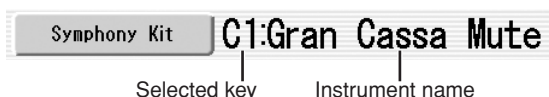

2 Simultaneously hold down the [CHANGE] button in the display and press the key on the Upper or Lower keyboard that corresponds to the instrument you want to use.

The instrument is instantly erased and replaced with the newly selected one.

About Quantize

The Quantize function is a process of rounding off timing or duration values, so that each note plays with precise timing. You can select nine types of Quantize value.

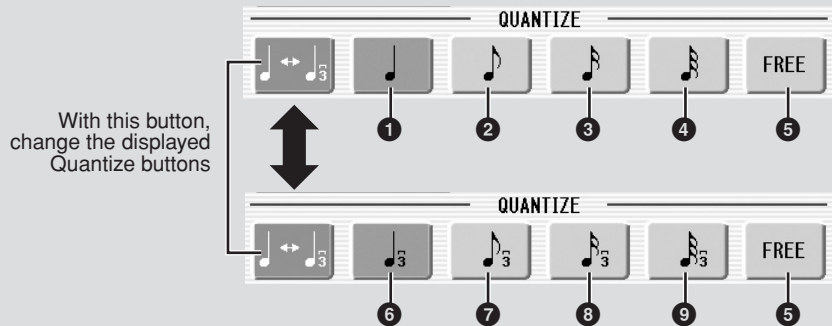

With Step Write

It allows you to automatically correct the length (duration) and timing of each note you enter.

Steps Depending on the Quantize Values

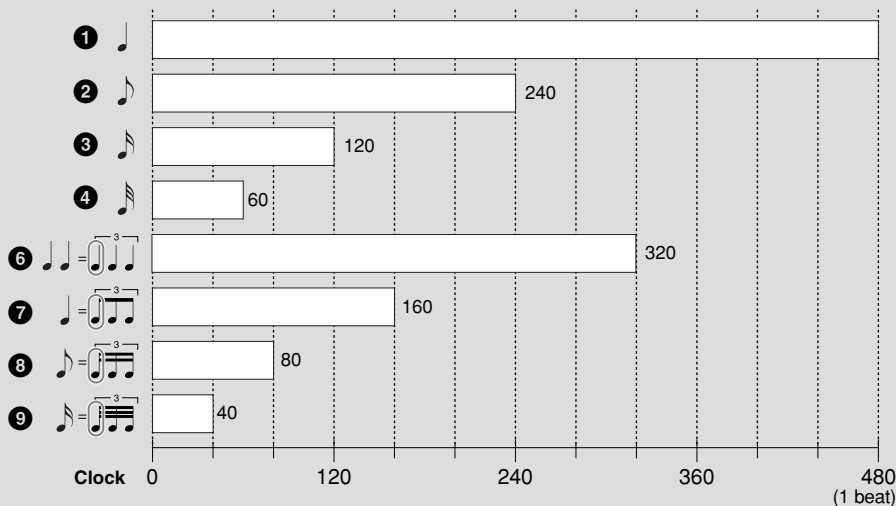

Setting Quantize to FREE (5) results in the finest, least amount of quantization (1/480 beat).

With Real Time Write

It allows you to automatically correct the timing of the notes you play, according to the specified Quantize resolution. No correction occurs when you select FREE. Generally, you should set Quantize to be the same as the shortest note you intend to play.

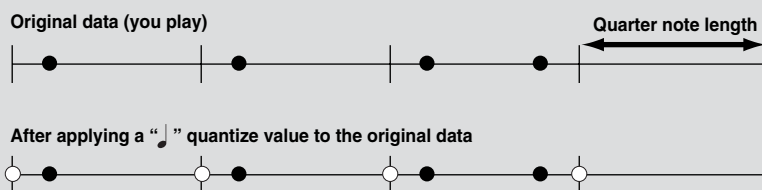

Entering Percussion Sounds to a Rhythm Pattern – Real Time Write

While you listen to the entered rhythm or metronome click, play the Upper/Lower keyboards to enter the desired percussion sounds.

- 1 Select the desired part to which the percussion sounds are entered, and the desired drum kit, by following Steps 1 – 3 on page 154.**
- 2 Set the appropriate Quantize value.**

The positions at which the sounds are input will be corrected according to the predetermined Quantize value in the Real Time Write operation. For details, refer to page 161.



- 3 Press the rhythm [START] button in the panel.**

The rhythm (or Metronome) starts playing, enabling the Real Time Write operation.



- 4 While the rhythm is running, play the percussion sounds from the Upper and/or Lower keyboards.**

If you have started the Rhythm Pattern Program by copying a preset rhythm, you can listen the selected rhythm as you play the sound. If you have started from scratch, set the Metronome to “on” in the SETTING Page and listen to the metronome click. The pattern will automatically repeat (or “loop”) for a certain number of measures as set in the SETTING Page.

- 5 Repeat steps #2 through #4 above to layer each instrument and complete your own rhythm.**



Reference Page

Metronome (page 152)

You can erase an instrument while rhythm is played.

To erase an instrument/key assignment:

While holding down the [CLEAR] button, press the key on the keyboard corresponding to the instrument you wish to erase. All instances of the selected instrument will be erased from the pattern.

When you want to erase all instruments, or edit entered percussion notes, you need to stop the rhythm then edit. See page 157, “Editing Entered Percussion Notes.”

Creating Backing Patterns (Rhythmic Chord Function)

The Rhythm Pattern Program allows you to use one of the DDK-7’s Accompaniment patterns with your original rhythm. You can select and save the Accompaniment pattern that best matches the rhythm that you have created. Moreover, Rhythm Pattern Program features a Rhythmic Chord function that lets you add your own backing patterns to the rhythms you create.

To select an appropriate Accompaniment pattern for your newly created rhythm:

- 1 Press the [SETTING] button at the top of the display to call up the SETTING Page.
- 2 Press the [ASSEMBLE] button.
A pop-up menu appears, letting you select the copy source and destination part.
- 3 Using the COPY FROM [RHYTHM] and [SECTION] buttons, select the rhythm and the section which has the accompaniment you wish to use.



Reference Page

Basic settings for the Rhythm Pattern (page 151)

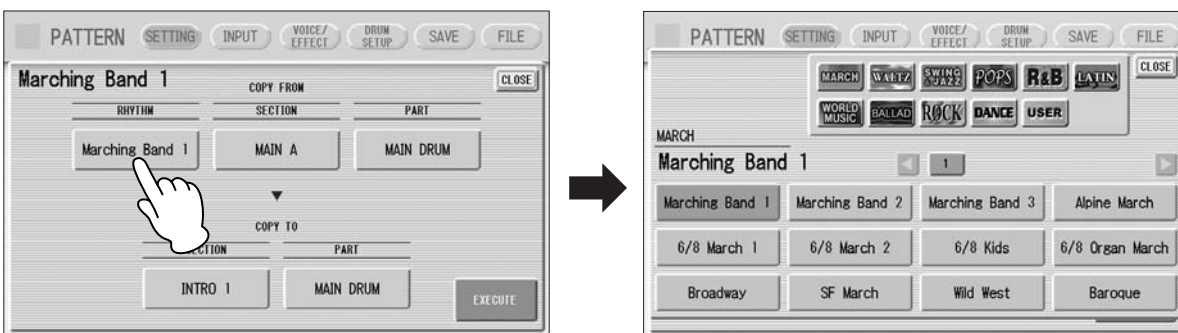

- 4 Using the COPY TO [PART] button, select the desired accompaniment part (CHORD 1 or CHORD 2) to be used for the Rhythmic Chord pattern.
- 5 Using the COPY FROM [PART] button, select the accompaniment part you want to copy.

6 Press the [EXECUTE] button to execute the copy.

The desired accompaniment part (Rhythmic Chord pattern) has been copied.

To create your own backing patterns with the Rhythmic Chord function:

The Rhythmic Chord pattern can be entered by the same methods as the rhythm: Step Write and/or Real Time Write.

- 1 Press the [INPUT] button at the top of the display to call up the INPUT Page.
- 2 Select the part, CHORD 1 or CHORD 2, which you want to create for the Rhythmic Chord pattern.

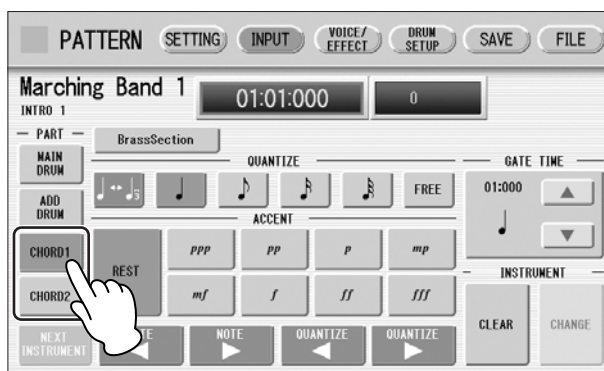

If the part you have select contains a preset accompaniment pattern, a message appears prompting you to confirm whether you want to clear the existing data or not. To create your own Rhythmic Chord pattern, select [CLEAR].



NOTE

The Voice menu that appears here is not the same as the one for the Voice Sections. See the Rhythm Program Voice List on page 179.

- 3 Select the desired Voice. Pressing the button showing the Voice name calls up the relevant Voice Menu. Select the desired Voice category with the instrument icon buttons, then select the desired Voice from the Voice Menu. The selected Voice is called up for both the Upper and Lower keyboards.

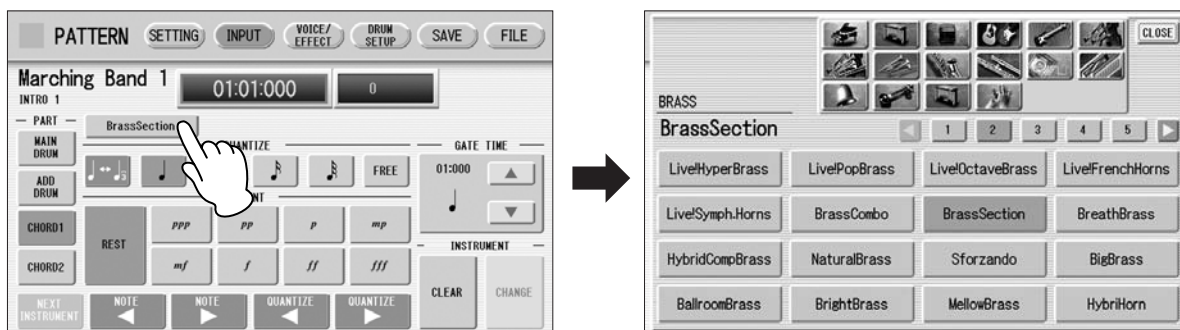

Voices can also be changed even after entering the Rhythmic Chord pattern. You can select only one Voice for one part (Chord 1 or Chord 2). When you want to create a Rhythmic Chord pattern including two different Voices, select one Voice for Chord 1 and another for Chord 2.

- 4 Set the appropriate Quantize value.**
For details on the Quantize function, refer to page 161.

- 5 Set the Gate Time.**
You can adjust the Gate Time setting by using GATE TIME ▲ ▼ buttons in the display, or Data Control dial.



Gate time determines the actual length of time a note sounds. For example, a quarter note is sometimes played as tenuto (long length) and sometimes played as staccato (short length). Since 1 beat is made up of 480 clocks, a quarter note played tenuto may have a gate time between 450 – 470, and a staccato quarter note may be about 240.

- 6 Enter the Rhythmic Chord pattern.**
The methods for entering the Rhythmic Chord pattern are the same as those for entering the rhythm pattern. Any key you press sounds a C major triad chord (C, E, and G). For information on Step Write, see page 156; for information on Real Time Write, see page 162.

You can also edit the entered Rhythmic Chord pattern using the same method as in “Editing Entered Percussion Notes” (page 157). To change the gate time of the notes of the Rhythmic Chord pattern, follow the instructions below.

To change the Gate Time:

- 1 Select the note for which you want to change the gate time (see Step 1 on page 157).
- 2 Press the Gate Time box to enable the box.



- 3 Turn the Data Control dial to change the Gate Time.

Changing the Voices for Accompaniment Parts

In Rhythm Pattern Program, you can create your original drum patterns using Main Drum and Add Drum, and original backing patterns using Chord 1 and Chord 2. Moreover, you can change the Voices for all accompaniment parts, including Pad, Phrase 1 and Phrase 2.

Voices can be changed in the VOICE/EFFECT Page.

- 1 Press the [VOICE/EFFECT] button at the top of the display to call up the VOICE/EFFECT Page.
- 2 Press the [VOICE] button in the display.
The following display will appear.

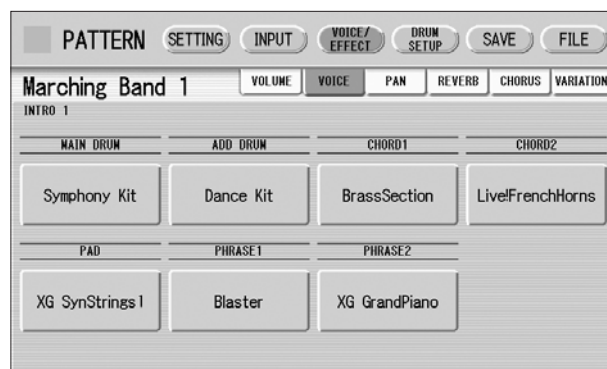

3 Select the desired part for which you wish to change the Voice.

The Voice menu appears.

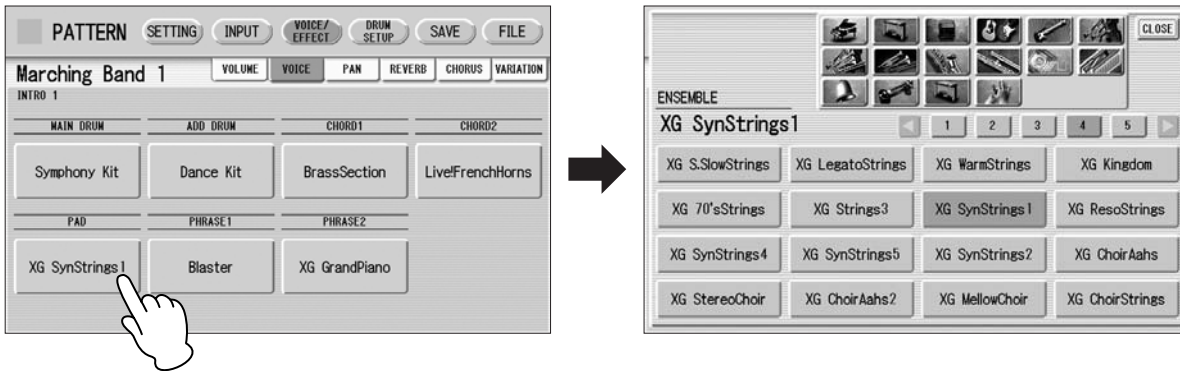

4 Select the desired Voice, and the Voice menu automatically closes.

After selecting the desired Voice, customize the accompaniment to your personal preference by adjusting the volume and pan, and setting the desired effects below.



NOTE

The Voice menu that appears here is not the same as the one for the Voice Sections. See the Rhythm Program Voice List on page 179.

Adjusting Volume and Panning

Volume and Pan are set in VOICE/EFFECT Page.

VOLUME Display

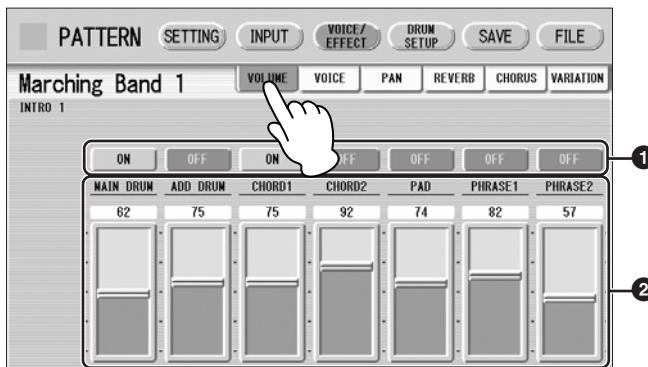

1 ON/OFF

Determines the on/off status of each accompaniment part. When this is set to OFF, the part is muted.

2 Volume sliders

Determines the volume of each accompaniment part.

Range: 0 – 127

PAN Display

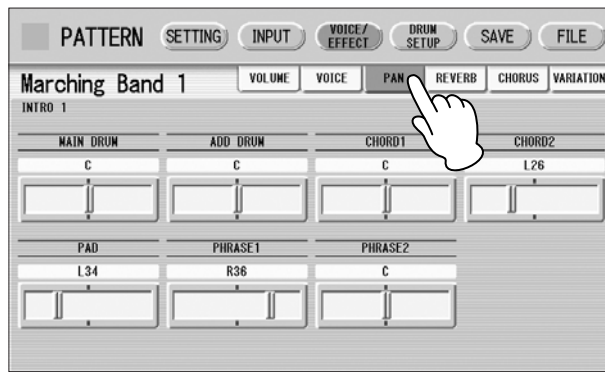

Determines the position of each accompaniment part in the stereo image.

Range: L64 – R63

Effect Settings

You can set Reverb, Chorus, and Variation effects as desired for your original rhythm. Reverb adds a warm ambience to the sound, simulating the complex reflections of actual performance spaces, such as a concert hall or a small club. Chorus provides a wide variety of sound transformations and enhancements. Variation includes many kinds of special effects for changing the sound, both subtly and radically. These effects are set in the VOICE/EFFECT Page.

REVERB Display

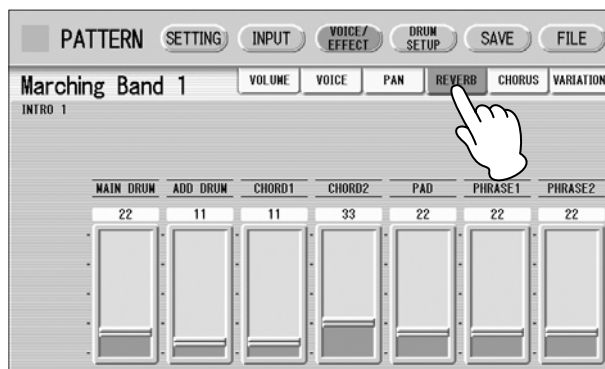

Determines the amount of reverb applied to each accompaniment part.

Range: 0 – 127

CHORUS Display

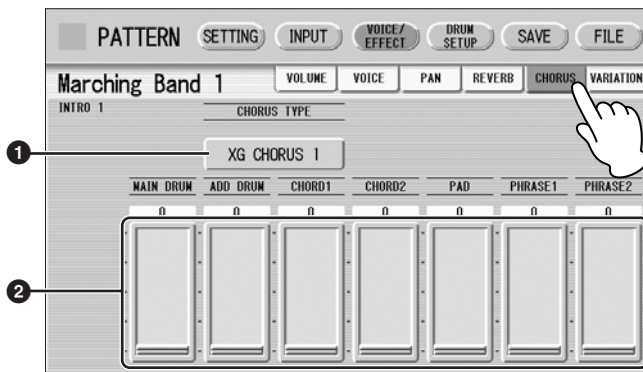

1 CHORUS TYPE

Determines the type of the chorus effect. Pressing the CHORUS TYPE button calls up the chorus type list.

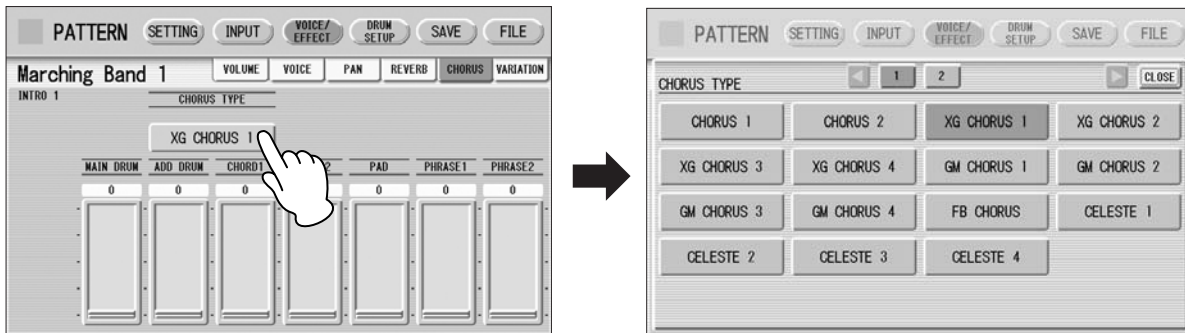

Select the desired chorus type, and the list automatically closes.

2 Chorus sliders

Determines the amount of chorus effect applied to each accompaniment part.

Range: 0 – 127

VARIATION Display

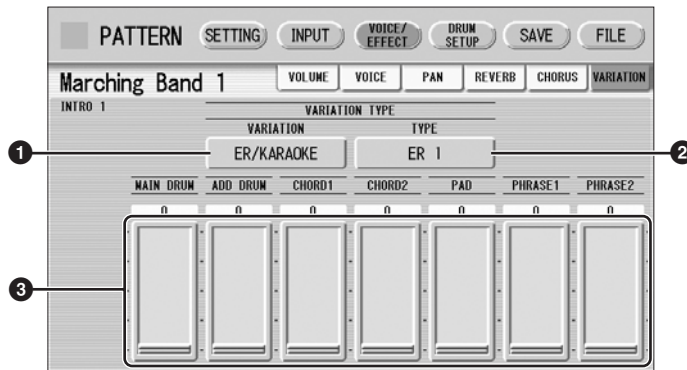

Reference Page

Effect List (page 52)

1 VARIATION (Variation Effect Category)

Selects the effect category of the variation effect. Pressing the VARIATION button calls up the effect category list.

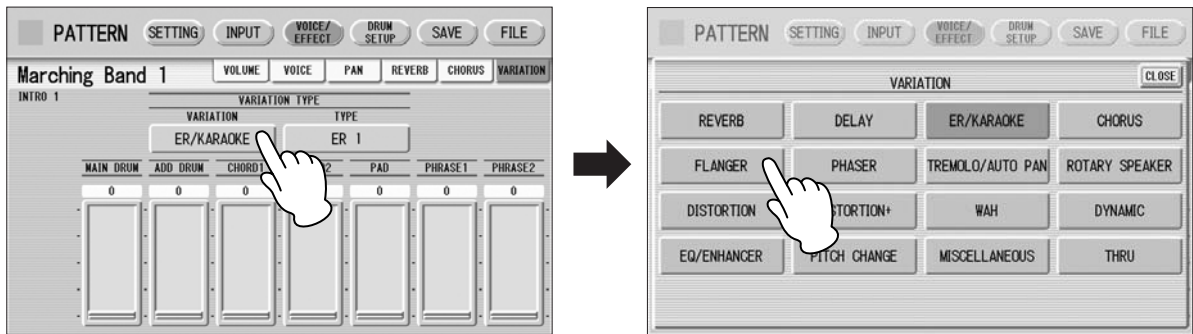

Select the desired effect category, and the list automatically closes. After changing the category, the variation type below automatically changes corresponding to the selected category.

2 TYPE (Variation Type)

Determines the type of the variation effect. Pressing the TYPE button calls up the effect type list.

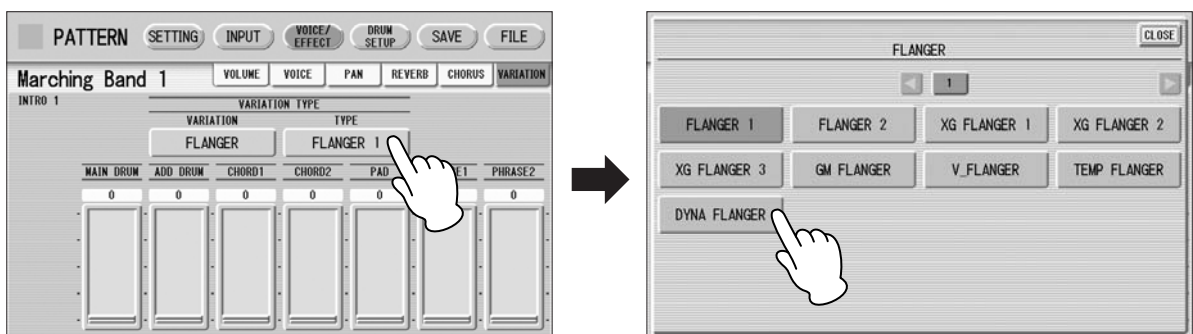

Select the desired type, and the list automatically closes.

3 Variation sliders

Determines the amount of Variation effect applied to each accompaniment part.

Range: 0 – 127

Detailed settings for each percussion instrument

You can independently adjust the settings of pan, pitch, reverb and volume for each instrument.

- 1 Press the [DRUM SETUP] button at the top of the display to call up the DRUM SETUP Page.
- 2 Select the desired part, Main Drum or Add Drum.

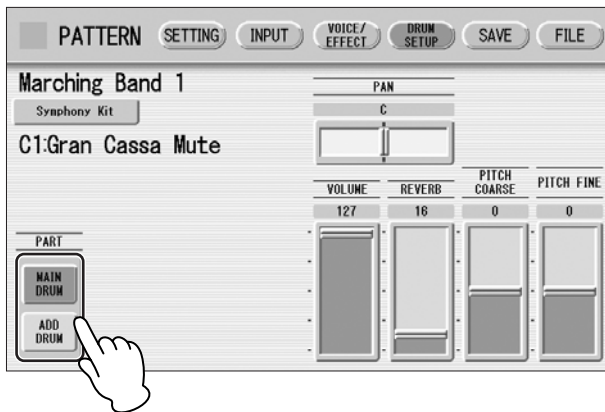

- 3 Press the appropriate key (the key to which the instrument to be changed is assigned).

The selected instrument's name is shown on the display and you can change its settings.

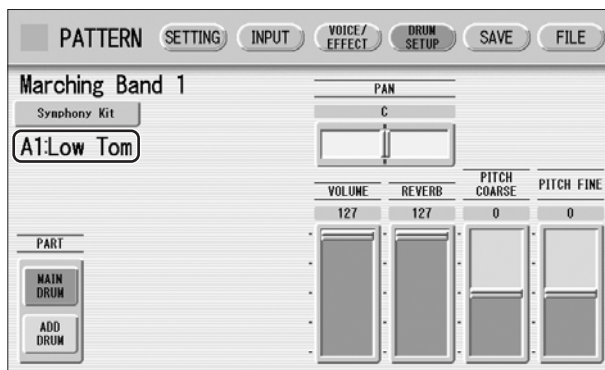

- 4 Adjust the parameters: Pan, Volume, Reverb and Pitch.

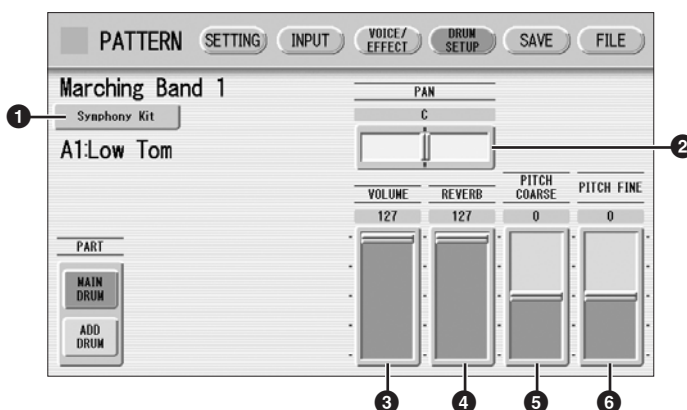



Reference Page

Percussion Kit List
(page 176)

1 Percussion Kit Name

Indicates the currently selected kit. Pressing this button calls up the Percussion Kit list, letting you select the desired kit. When you change the kit, the instruments you have already entered are replaced with the instruments of the newly selected kit.

2 PAN

Determines the position of the currently selected instrument in the stereo image.
Range: L63 – R63

3 VOLUME

Determines the volume of the currently selected instrument.
Range: 0 – 127

4 REVERB

Determines the amount of reverb applied to the currently selected instrument.
Range: 0 – 127

5 PITCH COARSE

Determines the pitch of the currently selected instrument, adjustable in semitone (100-cent) steps.
Range: -64 – +63

6 PITCH FINE

Determines the pitch of the currently selected instrument, adjustable in 1-cent steps, allowing more detailed tuning of the instrument than in PITCH COARSE (5) above.
Range: -64 – +63

Saving Rhythm Patterns

You can save your newly created rhythm pattern as a User Rhythm, up to a maximum of 48 patterns.

1 If necessary, confirm the contents of the rhythm you want to save.

For details, see page 173.

2 Press the [SAVE] button at the top right of the display to call up the SAVE Page.

If the rhythm is playing, it will automatically be stopped.

3 Select the User Rhythm number to which you wish to save.

The following display appears, prompting confirmation of the operation.

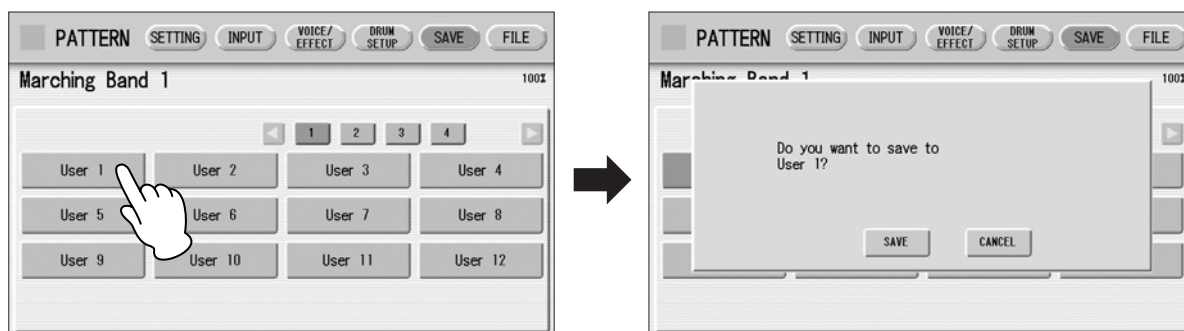

4 Press the [SAVE] button to save the pattern, or press [CANCEL] to abort the operation.

Remaining Memory (amount of memory available for storing rhythms) is shown on the display as a percentage.



When the pattern cannot be saved because of lack of available memory space, a “Data full” message appears. Return to the previous page by pressing [OK] in this case.

You should periodically save your rhythm as you are creating it and check the amount of remaining memory. If the rhythm currently being edited cannot be saved because of a lack of memory space, erase some of the less necessary percussion sounds with the [CLEAR] button in the INPUT Page, and try saving the pattern again.

After saving the Rhythm, be sure to quit Rhythm Pattern Program (page 174) before turning the power off. Turning off the DDK-7 without quitting Rhythm Pattern Program erases the User Rhythm you have created.

Confirming rhythm patterns before saving

The rhythm pattern you have created will be saved with 15 sections collectively into one rhythm. Before saving, we recommend that you confirm the contents of each section.

Example: When saving the Main A and Main B sections you have created into one user rhythm

First select “Main A” by using the [SECTION] button on the SETTING Page, then press the [START] button on the panel. This lets you hear the Main A pattern you have created. Confirm that the rhythm pattern is what you want to save as Main A. Next, select “Main B” by using the [SECTION] button, then play it back and confirm that this is what you want to save as Main B.

If the Main A and/or Main B patterns contain undesired data or no data, create the desired data by using the Assemble function (page 153).

After confirming the desired section (Main A and Main B here), we recommend that you confirm that all other sections contain no data. If unnecessary data is contained in some sections which you don't want to save, delete that unnecessary data. This can reduce the data size of the user rhythm.

Quitting the Rhythm Pattern Program

You can quit the Rhythm Pattern Program from any of its display pages.

- 1 Press the [PROGRAM] button.**

If a rhythm is playing, it will automatically be stopped.
If you leave Rhythm Pattern Program without having edited any patterns, this simply quits the Rhythm Pattern Program.
If you have not saved the edited pattern, a message appears, prompting confirmation of the operation.
- 2 Select [EXIT] to leave Rhythm Pattern Program, or [CANCEL] to abort the operation and return to the previous display.**



When you leave the Rhythm Pattern Program, the square at the top left in the display turns light blue for a few seconds, indicating that data is currently being saved. Do not turn the power off while the data is being saved.

Recalling User Rhythm Patterns

The User rhythms you have created in the Rhythm Pattern Program can be selected and played from the User menu. Refer to Chapter 5, “Selecting rhythms with the Rhythm button” (page 60).

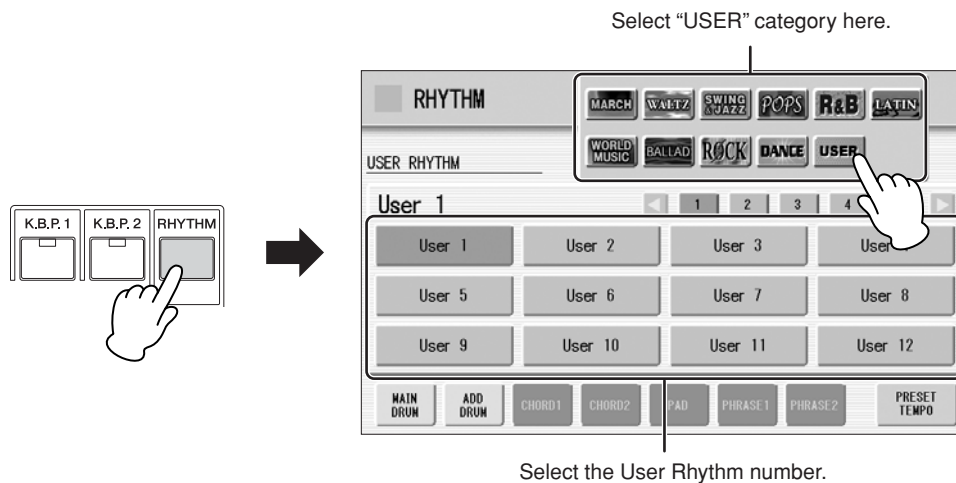

Selecting Rhythm from an External Media

You can load rhythms from a USB flash memory, or other external media and edit and save them as User Rhythms. Data that can be loaded includes not only that of the DDK-7, but also all Style File Format files.

- 1 Insert the media which contains the desired pattern into the USB TO DEVICE terminal.**
- 2 Press the [PROGRAM] button on the panel.**
- 3 Press [FILE] at the top right in the display.**
If you open the FILE Page while the rhythm is playing, the rhythm will automatically be stopped.
- 4 Press the [SELECT] button to select the desired pattern file.**
The method for selecting a file is the same as that in the M.D.R. section. See page 104 for more information.

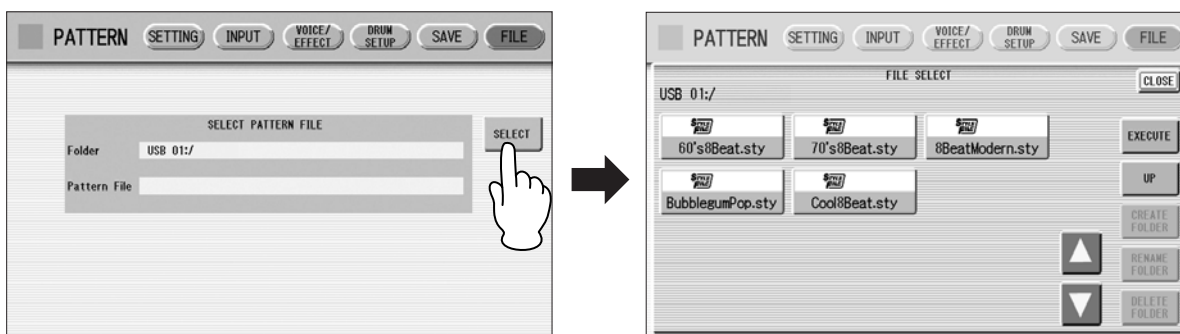

- 5 Press [EXECUTE] or press the highlighted, selected button again to load the pattern.**
To edit the loaded pattern, go to the INPUT Page (page 157), then save your created pattern(s) as a User Rhythm (page 172).

About file types that can be loaded to the DDK-7

This DDK-7 is compatible with Style File Format data. The Style File Format (SFF) is Yamaha's original style data format, which uses a unique conversion system to provide high-quality automatic accompaniment based on a wide range of chord types. In this format, each rhythm pattern (called a "style") is made up of fifteen sections (Intro 1 – 3, Main A – D, Fill In A – D, Break, Ending 1 – 3) as rhythm pattern variations. Each of these fifteen sections in turn has eight different parts, made up of MIDI sequence data.

You can load any patterns (styles) which have been created by an SFF-compatible instrument. Instruments compatible with SFF have the Style File Logo on the panel.



Percussion Kit List

		Standard Kit 1 Live!Std Kit Live!Std+P Kit	Standard Kit 2 Live!Funk Kit Live!Funk+P Kit	Hit Kit	Room Kit	Rock Kit	Electro Kit
Lower Keyboard	C-1	C#-1	Surdo Mute	Surdo Mute	Surdo Mute	Surdo Mute	Surdo Mute
	D-1		Surdo Open	Surdo Open	Surdo Open	Surdo Open	Surdo Open
	D#-1	D#-1	Hi Q	Hi Q	Hi Q	Hi Q	Hi Q
	E-1		Whip Slap	Whip Slap	Whip Slap	Whip Slap	Whip Slap
	F-1		Scratch H	Scratch H	Scratch H	Scratch H	Scratch H
	F#-1	F#-1	Scratch L	Scratch L	Scratch L	Scratch L	Scratch L
	G-1		Finger Snap	Finger Snap	Finger Snap	Finger Snap	Finger Snap
	G#-1	G#-1	Click Noise	Click Noise	Click Noise	Click Noise	Click Noise
	A-1		Metronome Click	Metronome Click	Metronome Click	Metronome Click	Metronome Click
	A#-1	A#-1	Metronome Bell	Metronome Bell	Metronome Bell	Metronome Bell	Metronome Bell
	B-1		Seq Click L	Seq Click L	Seq Click L	Seq Click L	Seq Click L
	C0		Seq Click H	Seq Click H	Seq Click H	Seq Click H	Seq Click H
	C#0	C#0	Brush Tap	Brush Tap	Brush Tap	Brush Tap	Brush Tap
	D0		Brush Swirl*	Brush Swirl*	Brush Swirl*	Brush Swirl*	Brush Swirl*
	D#0	D#0	Brush Slap	Brush Slap	Brush Slap	Brush Slap	Brush Slap
	E0		Brush Tap Swirl*	Brush Tap Swirl*	Brush Tap Swirl*	Brush Tap Swirl*	Reverse Cymbal*
	F0		Snare Roll*	Snare Roll*	Snare Roll*	Snare Roll*	Snare Roll*
	F#0	F#0	Castanet	Castanet	Castanet	Castanet	Hi Q 2
	G0		Snare Soft	Snare Soft 2	Snare Electro	Snare Soft	Snare Noisy
	G#0	G#0	Sticks	Sticks	Sticks	Sticks	Sticks
	A0		Kick Soft	Kick Soft	Kick Tight L	Kick Soft	Kick Soft
	A#0	A#0	Open Rim Shot	Open Rim Shot H	Snare Pitched	Open Rim Shot	Open Rim Shot
	B0		Kick Tight	Kick Tight	Kick Wet	Kick Tight	Kick 2
	C1		Kick	Kick Short	Kick Tight H	Kick	Kick Gate
	C#1	C#1	Side Stick	Side Stick Light	Stick Ambient	Side Stick	Side Stick
	D1		Snare	Snare Short	Snare Ambient	Snare Snappy	Snare Rock
	D#1	D#1	Hand Clap	Hand Clap	Hand Clap	Hand Clap	Hand Clap
	E1		Snare Tight	Snare Tight H	Snare Tight 2	Snare Tight Snap	Snare Rock Tight
	F1		Floor Tom L	Floor Tom L	Hybrid Tom 1	Tom Room 1	Tom Rock 1
	F#1	F#1	Hi-Hat Closed	Hi-Hat Closed	Hi-Hat Closed 2	Hi-Hat Closed	Hi-Hat Closed
	G1		Floor Tom H	Floor Tom H	Hybrid Tom 2	Tom Room 2	Tom Rock 2
	G#1	G#1	Hi-Hat Pedal	Hi-Hat Pedal	Hi-Hat Pedal 2	Hi-Hat Pedal	Hi-Hat Pedal
A1		Low Tom	Low Tom	Hybrid Tom 3	Tom Room 3	Tom Rock 3	
A#1	A#1	Hi-Hat Open	Hi-Hat Open	Hi-Hat Open 2	Hi-Hat Open	Hi-Hat Open	
B1		Mid Tom L	Mid Tom L	Hybrid Tom 4	Tom Room 4	Tom Rock 4	
C2		Mid Tom H	Mid Tom H	Hybrid Tom 5	Tom Room 5	Tom Rock 5	
C#2	C#2	Crash Cymbal 1	Crash Cymbal 1	Crash Cymbal 1	Crash Cymbal 1	Crash Cymbal 1	
D2		High Tom	High Tom	Hybrid Tom 6	Tom Room 6	Tom Rock 6	
D#2	D#2	Ride Cymbal 1	Ride Cymbal 1	Ride Cymbal 1	Ride Cymbal 1	Ride Cymbal 1	
E2		Chinese Cymbal	Chinese Cymbal	Chinese Cymbal	Chinese Cymbal	Chinese Cymbal	
F2		Ride Cymbal Cup	Ride Cymbal Cup	Ride Cymbal Cup	Ride Cymbal Cup	Ride Cymbal Cup	
F#2	F#2	Tambourine	Tambourine	Tambourine Light	Tambourine	Tambourine	
G2		Splash Cymbal	Splash Cymbal	Splash Cymbal	Splash Cymbal	Splash Cymbal	
G#2	G#2	Cowbell	Cowbell	Cowbell	Cowbell	Cowbell	
A2		Crash Cymbal 2	Crash Cymbal 2	Crash Cymbal 2	Crash Cymbal 2	Crash Cymbal 2	
A#2	A#2	Vibraslap	Vibraslap	Vibraslap	Vibraslap	Vibraslap	
B2		Ride Cymbal 2	Ride Cymbal 2	Ride Cymbal 2	Ride Cymbal 2	Ride Cymbal 2	
C3		Bongo H	Bongo H	Bongo H	Bongo H	Bongo H	
C#3	C#3	Bongo L	Bongo L	Bongo L	Bongo L	Bongo L	
D3		Conga H Mute	Conga H Mute	Conga H Mute	Conga H Mute	Conga H Mute	
D#3	D#3	Conga H Open	Conga H Open	Conga H Open	Conga H Open	Conga H Open	
E3		Conga L	Conga L	Conga L	Conga L	Conga L	
F3		Timbale H	Timbale H	Timbale H	Timbale H	Timbale H	
F#3	F#3	Timbale L	Timbale L	Timbale L	Timbale L	Timbale L	
G3		Agogo H	Agogo H	Agogo H	Agogo H	Agogo H	
G#3	G#3	Agogo L	Agogo L	Agogo L	Agogo L	Agogo L	
A3		Cabasa	Cabasa	Cabasa	Cabasa	Cabasa	
A#3	A#3	Maracas	Maracas	Maracas	Maracas	Maracas	
B3		Samba Whistle H*	Samba Whistle H*	Samba Whistle H*	Samba Whistle H*	Samba Whistle H*	
C4		Samba Whistle L*	Samba Whistle L*	Samba Whistle L*	Samba Whistle L*	Samba Whistle L*	
C#4	C#4	Guiro Short	Guiro Short	Guiro Short	Guiro Short	Guiro Short	
D4		Guiro Long*	Guiro Long*	Guiro Long*	Guiro Long*	Guiro Long*	
D#4	D#4	Claves	Claves	Claves	Claves	Claves	
E4		Wood Block H	Wood Block H	Wood Block H	Wood Block H	Wood Block H	
F4		Wood Block L	Wood Block L	Wood Block L	Wood Block L	Wood Block L	
F#4	F#4	Cuica Mute	Cuica Mute	Cuica Mute	Cuica Mute	Scratch H 2	
G4		Cuica Open	Cuica Open	Cuica Open	Cuica Open	Scratch L 2	
G#4	G#4	Triangle Mute	Triangle Mute	Triangle Mute	Triangle Mute	Triangle Mute	
A4		Triangle Open	Triangle Open	Triangle Open	Triangle Open	Triangle Open	
A#4	A#4	Shaker	Shaker	Shaker	Shaker	Shaker	
B4		Jingle Bells	Jingle Bells	Jingle Bells	Jingle Bells	Jingle Bells	
C5		Bell Tree	Bell Tree	Bell Tree	Bell Tree	Bell Tree	
C#5	C#5						
D5							
D#5	D#5						
E5							
F5							
F#5	F#5						
G5							

*: Indicates an instrument which requires the Gate Time setting.

Lower Keyboard

Upper Keyboard

		Analog Kit	Dance Kit	Jazz Kit	Brush Kit	Symphony Kit	Multi Kit 1
C-1	C#-1	Surdo Mute	Kick Dance 1	Surdo Mute	Surdo Mute	Surdo Mute	Scratch
D-1	D#-1	Surdo Open	Kick Dance 2	Surdo Open	Surdo Open	Surdo Open	Concert BD
E-1		Hi Q	Hi Q	Hi Q	Hi Q	Hi Q	Noise Percussion
F-1	F#-1	Whip Slap	Whip Slap*	Whip Slap	Whip Slap	Whip Slap	Bass Drum March
G-1	G#-1	Scratch H	Scratch Dance 1*	Scratch H	Scratch H	Scratch H	Analog BD Short
A-1	A#-1	Scratch L	Scratch Dance 2*	Scratch L	Scratch L	Scratch L	Synth Tom 3
B-1		Finger Snap	Finger Snap	Finger Snap	Finger Snap	Finger Snap	Analog BD Long
C0	C#0	Click Noise	Click Noise	Click Noise	Click Noise	Click Noise	Synth Tom 2
D0	D#0	Metronome Click	Dance Perc 1	Metronome Click	Metronome Click	Metronome Click	Synth Bass Drum
E0		Metronome Bell	Reverse Dance 1	Metronome Bell	Metronome Bell	Metronome Bell	Synth Tom 1
F0	F#0	Seq Click L	Dance Perc 2	Seq Click L	Seq Click L	Seq Click L	Bass Drum Attack
G0	G#0	Seq Click H	Hi Q Dance 1	Seq Click H	Seq Click H	Seq Click H	Bass Drum Heavy
A0	A#0	Brush Tap	Snare Analog 3	Brush Tap	Brush Tap	Brush Tap	Tom 4
B0		Brush Swirl*	Vinyl Noise*	Brush Swirl*	Brush Swirl*	Brush Swirl*	Bass Drum Light
C1	C#1	Brush Slap	Snare Analog 4	Brush Slap	Brush Slap	Brush Slap	Tom 3
D1	D#1	Reverse Cymbal*	Reverse Cymbal*	Brush Tap Swirl*	Brush Tap Swirl*	Brush Tap Swirl*	Orch Snare Drum
E1		Snare Roll*	Reverse Dance 2*	Snare Roll*	Snare Roll*	Snare Roll*	Snare Drum Roll*
F1	F#1	Hi Q 2	Hi Q 2	Castanet	Castanet	Castanet	Tom 2
G1	G#1	Snare Noisy 4	Snare Techno	Snare Jazz H	Brush Slap 2	Snare Soft	SD Brush Roll
A1	A#1	Sticks	Snare Dance 1	Sticks	Sticks	Sticks	Tom 1
B1		Kick 3	Kick Techno Q	Kick Soft	Kick Soft	Kick Soft 2	SD Brush Shot 2
C2	C#2	Open Rim Shot	Rim Gate	Open Rim Shot	Open Rim Shot	Open Rim Shot	Tom Brush Shot 4
D2	D#2	Kick Anlg Short	Kick Techno L	Kick Tight	Kick Tight	Gran Cassa	SD Brush Shot 1
E2		Kick Analog	Kick Techno	Kick Jazz	Kick Jazz	Gran Cassa Mute	Snare Drum Heavy
F2	F#2	Side Stick Anlg	Side Stick Anlg	Side Stick Light	Side Stick Light	Side Stick	Tom Brush Shot 3
G2	G#2	Snare Analog	Snare Clap	Snare Jazz L	Brush Slap 3	Band Snare	Snare Drum Light
A2	A#2	Hand Clap	Dance Clap	Hand Clap	Hand Clap	Hand Clap	Tom Brush Shot 2
B2		Snare Analog 2	Snare Dry	Snare Jazz M	Brush Tap 2	Band Snare 2	SD Accent 2
C3	C#3	Tom Analog 1	Tom Dance 1	Floor Tom L	Tom Brush 1	Floor Tom L	SD Accent 1
D3	D#3	Hat Close Analog	Hi-Hat Closed 3	Hi-Hat Closed	Hi-Hat Closed	Hi-Hat Closed	Tom Brush Shot 1
E3		Tom Analog 2	Tom Dance 2	Floor Tom H	Tom Brush 2	Floor Tom H	SD Reverb 2
F3	F#3	Hat Close Anlg 2	Hat Close Anlg 3	Hi-Hat Pedal	Hi-Hat Pedal	Hi-Hat Pedal	Snare Drum Rim 2
G3	G#3	Tom Analog 3	Tom Dance 3	Low Tom	Tom Brush 3	Low Tom	SD Reverb 1
A3	A#3	Hat Open Analog	Hi-Hat Open 3	Hi-Hat Open	Hi-Hat Open	Hi-Hat Open	Snare Drum Rim 1
B3		Tom Analog 4	Tom Dance 4	Mid Tom L	Tom Brush 4	Mid Tom L	Synth Snare Drum
C4	C#4	Tom Analog 5	Tom Dance 5	Mid Tom H	Tom Brush 5	Mid Tom H	Analog SD
D4	D#4	Crash Analog	Crash Analog	Crash Cymbal 1	Crash Cymbal 1	Hand Cymbal	Triangle Mute
E4		Tom Analog 6	Tom Dance 6	High Tom	Tom Brush 6	High Tom	Tambourine
F4	F#4	Ride Cymbal 1	Ride Cymbal 1	Ride Cymbal 1	Ride Cymbal 1	Hand Cymbal S	Triangle Open
G4	G#4	Chinese Cymbal	Chinese Cymbal	Chinese Cymbal	Chinese Cymbal	Chinese Cymbal	Castanet
A4	A#4	Ride Cymbal Cup	Ride Cymbal Cup	Ride Cymbal Cup	Ride Cymbal Cup	Ride Cymbal Cup	Claves
B4		Tambourine	Tambourine Anlg	Tambourine	Tambourine	Tambourine	
C5	C#5	Splash Cymbal	Splash Cymbal	Splash Cymbal	Splash Cymbal	Splash Cymbal	Cabasa
D5	D#5	Cowbell Analog	Cowbell Dance	Cowbell	Cowbell	Cowbell	
E5		Crash Cymbal 2	Crash Cymbal 2	Crash Cymbal 2	Crash Cymbal 2	Hand Cymbal 2	Finger Snap
F5	F#5	Vibraslap	Vibraslap Analog	Vibraslap	Vibraslap	Vibraslap	
G5	G#5	Ride Cymbal 2	Ride Analog	Ride Cymbal 2	Ride Cymbal 2	Hand Cymbal 2 S	Hand Claps
A5	A#5	Bongo H	Bongo Analog H	Bongo H	Bongo H	Bongo H	Crash Cymbal 2
B5		Bongo L	Bongo Analog L	Bongo L	Bongo L	Bongo L	Hi-Hat Close
C6	C#6	Conga Analog H	Conga Analog H	Conga H Mute	Conga H Mute	Conga H Mute	Crash Cymbal 1
D6	D#6	Conga Analog M	Conga Analog M	Conga H Open	Conga H Open	Conga H Open	Hi-Hat Open
E6		Conga Analog L	Conga Analog L	Conga L	Conga L	Conga L	Crash Cym Mute
F6	F#6	Timbale H	Timbale H	Timbale H	Timbale H	Timbale H	Ride Cymbal 2
G6	G#6	Timbale L	Timbale L	Timbale L	Timbale L	Timbale L	Hi-Hat Pedal 2
A6	A#6	Agogo H	Agogo H	Agogo H	Agogo H	Agogo H	Ride Cymbal 1
B6		Agogo L	Agogo L	Agogo L	Agogo L	Agogo L	Hi-Hat Pedal 1
C7	C#7	Cabasa	Cabasa	Cabasa	Cabasa	Cabasa	Ride Cymbal Cup
D7	D#7	Maracas 2	Maracas 2	Maracas	Maracas	Maracas	
E7		Samba Whistle H*	Samba Whistle H*	Samba Whistle H*	Samba Whistle H*	Samba Whistle H*	Cym Brush Shot
F7	F#7	Samba Whistle L*	Samba Whistle L*	Samba Whistle L*	Samba Whistle L*	Samba Whistle L*	Cymbal March
G7	G#7	Guiro Short	Guiro Short	Guiro Short	Guiro Short	Guiro Short	Analog HH Close
A7	A#7	Guiro Long*	Guiro Long*	Guiro Long*	Guiro Long*	Guiro Long*	Orch Cymbal Roll
B7		Claves 2	Claves 2	Claves	Claves	Claves	Analog HH Open
C8	C#8	Wood Block H	Dance Perc 3	Wood Block H	Wood Block H	Wood Block H	Orchestra Cymbal
D8	D#8	Wood Block L	Dance Perc 4*	Wood Block L	Wood Block L	Wood Block L	Orch Cymbal Mute
E8		Scratch H 2	Dance Breath 1	Cuica Mute	Cuica Mute	Cuica Mute	
F8	F#8	Scratch L 2	Dance Breath 2*	Cuica Open	Cuica Open	Cuica Open	Tam-Tam
G8	G#8	Triangle Mute	Triangle Mute	Triangle Mute	Triangle Mute	Triangle Mute	
A8	A#8	Triangle Open	Triangle Open	Triangle Open	Triangle Open	Triangle Open	
B8		Shaker	Shaker	Shaker	Shaker	Shaker	
C9	C#9	Jingle Bells	Jingle Bells	Jingle Bells	Jingle Bells	Jingle Bells	
D9	D#9	Bell Tree	Bell Tree	Bell Tree	Bell Tree	Bell Tree	
E9							
F9	F#9						
G9	G#9						

*: Indicates an instrument which requires the Gate Time setting.

Lower Keyboard

Upper Keyboard

		Multi Kit 2	Live!Studio Kit	SFX Kit 1	SFX Kit 2	Arabic Kit	Cuban Kit	Pop Latin Kit
C-1	C#-1	Maracas High	Surdo Mute					
D-1		Surdo Mute	Surdo Open					
	D#-1	Maracas Low	Hi Q					
E-1		Surdo Muff	Whip Slap					
F-1		Surdo Rim	Scratch H					
	F#-1	Cuica High	Scratch L					Hand Clap
G-1		Surdo Open	Finger Snap					
	G#-1	Cuica Middle	Click Noise					
A-1		Tamborim Mute	Metronome Click					
	A#-1	Cuica Low	Metronome Bell				Conga H Tip	Conga H Tip
B-1		Tamborim Open	Seq Click L				Conga H Heel	Conga H Heel
		Pandeiro	Seq Click H			Nakarazan Dom	Conga H Open	Conga H Open
C0								
	C#0	Bongo High	Brush Tap			Cabasa	Conga H Mute	Conga H Mute
D0		Conga Slide	Brush Swirl*			Nakarazan Edge	Conga H SlapOpen	Conga H SlapOpen
	D#0	Bongo Low	Brush Slap			Hager Dom	Conga H Slap	Conga H Slap
E0		Conga Slap	Brush Tap Swirl*			Hager Edge	Conga H SlapMute	Conga H SlapMute
F0		Conga Muff	Snare Roll*			Bongo H	Conga L Tip	Conga L Tip
	F#0	Bongo Mute	Castanet			Bongo L	Conga L Heel	Conga L Heel
G0		Conga High	Snare Studio L			Conga H Mute	Conga L Open	Conga L Open
	G#0	Bongo Slap	Sticks			Conga H Open	Conga L Mute	Conga L Mute
A0		Conga Low	Kick Ambience H			Conga L	Conga L SlapOpen	Conga L SlapOpen
	A#0		Open Rim Shot			Zagrouda H	Conga L Slap	Conga L Slap
B0		Timbale 1 High	Kick Ambience L			Zagrouda L*	Conga L Slide*	Conga L Slide*
		Timbale 1 Low	Kick Studio	Cutting Noise 1*	Phone Call*	Kick Soft	Bongo H Open 1 f	Bongo H Open 1 f
C1								
	C#1		Side Stick	Cutting Noise 2*	Door Squeak*	Side Stick	Bongo H Open 3 f	Bongo H Open 3 f
D1		Timbale 2 High	Snare Studio M		Door Slam*	Snare Soft	Bongo H Rim	Bongo H Rim
	D#1		Hand Clap	String Slap*	Scratch Cut*	Arabic Hand Clap	Bongo H Tip	Bongo H Tip
E1		Timbale 2 Low	Snare Studio L		Scratch H 3*	Snare Drum	Bongo H Heel	Bongo H Heel
F1		Timbale 3 High	Floor Tom L		Wind Chime*	Floor Tom L	Bongo H Slap	Bongo H Slap
	F#1	Woodblock High	Hi-Hat Closed		Telephone Ring*	Hi-Hat Closed	Bongo L Open 1 f	Bongo L Open 1 f
G1		Timbale 3 Low	Floor Tom H			Floor Tom H	Bongo L Open 3 f	Bongo L Open 3 f
	G#1	Woodblock Mid	Hi-Hat Pedal			Hi-Hat Pedal	Bongo L Rim	Bongo L Rim
A1		Timbale 4 High	Low Tom			Low Tom	Bongo L Tip	Bongo L Tip
	A#1	Woodblock Low	Hi-Hat Open			Hi-Hat Open	Bongo L Heel	Bongo L Heel
B1		Timbale 4 Low	Mid Tom L			Mid Tom L	Bongo L Slap	Bongo L Slap
		Vibraslap	Mid Tom H			Mid Tom H	Timbale L Open	Timbale L Open
C2								
	C#2	Triangle Mute	Crash Cymbal 1			Crash Cymbal 1		
D2		Tambourine	High Tom			High Tom		
	D#2	Triangle Open	Ride Cymbal 1			Ride Cymbal 1		
E2		Castanet	Chinese Cymbal	Flute Key Click*	CarEngnIgnition*	Crash Cymbal 2		
F2		Claves	Ride Cymbal Cup		Car Tires Squeal*	Duhulla Dom	Paila L	Paila L
	F#2		Tambourine		Car Passing*	Tambourine	Timbale H Open	Timbale H Open
G2		Cabasa	Splash Cymbal		Car Crash*	Duhulla Tak		
	G#2		Cowbell		Siren*	Cowbell		
A2		Finger Snap	Crash Cymbal 2		Train*	Duhulla Sak		
	A#2		Vibraslap		Jet Plane*	Claves		
B2		Hand Claps	Ride Cymbal 2		Starship*	Doff Dom	Paila H	Paila H
		Wind Bell Down	Bongo H		Burst*	Katem Dom	Cowbell Top	Cowbell Top
C3								
	C#3	Agogo High	Bongo L		Roller Coaster*	Katem Tak		
D3		Wind Bell Up	Conga H Mute		Submarine*	Katem Sak		
	D#3	Agogo Low	Conga H Open			Katem Tak		
E3		Bells	Conga L			Doff Tak	Guiro Short	Guiro Short
F3		Cowbell 4	Timbale H			Tabla Dom	Guiro Long*	Guiro Long*
	F#3	Shaker	Timbale L			Tabla Tak 1		
G3		Cowbell 3	Agogo H			Tabla Tik		
	G#3	Guiro Short	Agogo L	Shower*	Laugh*	Tabla Tak 2	Tambourine	Tambourine
A3		Cowbell 2	Cabasa	Thunder*	Scream*	Tabla Sak		
	A#3	Guiro Long	Maracas	Wind*	Punch*	Tabla Roll Edge*		
B3		Cowbell 1	Samba Whistle H*	Stream*	Heart Beat*	Tabla Flam		
		Taiko 2	Samba Whistle L*	Bubble*	Foot Steps*	Sagat 1	Maracas	Maracas
C4								
	C#4	Ohndaiko 2	Guiro Short	Feed*		Tabel Dom	Shaker	Shaker
D4		Taiko 1	Guiro Long*			Sagat 3	Cabasa	Cabasa
	D#4	Ohndaiko 1	Claves			Tabel Tak		Cuica Mute
E4		Ohtsuzumi 2	Wood Block H			Sagat 2		Cuica Open
F4		Ohtsuzumi 1	Wood Block L			Rik Dom		
	F#4	Kakegoe 3	Cuica Mute			Rik Tak 2		
G4		Kotsuzumi 4	Cuica Open			Rik Finger 1		
	G#4	Kakegoe 2	Triangle Mute			Rik Tak 1		
A4		Kotsuzumi 3	Triangle Open			Rik Finger 2		Triangle Mute
	A#4	Kakegoe 1	Shaker			Rik BrassTremolo*		Triangle Open
B4		Kotsuzumi 2	Jingle Bells			Rik Sak		
		Kotsuzumi 1	Bell Tree	Dog*	Machine Gun*	Rik Tik		Wind Chime
C5								
	C#5			Horse*	Laser Gun*			
D5				Bird Tweet*	Explosion*			
	D#5				Firework*			
E5								
F5								
	F#5			Ghost*				
G5				Maou*				

*: Indicates an instrument which requires the Gate Time setting.

Rhythm Program Voice List

PIANO	
1	Live!GrandPiano
	BrightPiano
	Harpsichord
	GrandHarpsi
	HonkyTonk
	Live!WarmGrand
	BalladStack
	MIDIGrand
	OctavePiano1
	OctavePiano2
	CP80
	Cool!GalaxyEP
	StageEP
	PolarisEP
	JazzChorus
	HyperTines
2	Cool!E.Piano
	PhaseEP
	NewTines
	FunkEP
	DXModern
	SmoothTine
	ChorusBell
	VintageEP
	VenusEP
	ModernEP
	TremoloEP
	SuperDX
	SuitcaseEP
	StereoClavi.
	PhaseClavi.
	Clavi.
3	WahClavi.
	XG GrandPiano
	XG GrndPianoKSP
	XG MellowGrPno
	XG PianoStrings
	XG Dream
	XG BrightPiano
	XG BritePnoKSP
	XG El. GrandPiano
	XG El. GrPnoKSP
	XG DetunedCP80
	XG LayeredCP1
	XG LayeredCP2
	XG Honkytonk
	XG HonkytonkKSP
	XG El.Piano1
4	XG El.Piano1KSP
	XG MellowEP1
	XG ChorusEP1
	XG HardEl.Piano
	XG VxfadeEl.P1
	XG 60'sEl.Piano1
	XG El.Piano2
	XG El.Piano2KSP
	XG ChorusEP2
	XG DXEPHard
	XG DXLegend
	XG DXPhaseEP
	XG DX+AnalogEP
	XG DXKotoEP
	XG VxfadeEl.P2
	XG Harpsichord
5	XG Harpsi.KSP
	XG Harpsichord2
	XG Harpsichord3
	XG Clavi.
	XG Clavi.KSP
	XG Clavi.Wah
	XG PulseClavi.
	XG PierceClavi.

CHROMATIC PERC.	
1	Vibraphone
	JazzVibes
	Suspense
	Marimba
	Xylophone
	SteelDrums
	Celesta
	Glockenspiel
	MusicBox
	TubularBell
	Kalimba
	Dulcimer
	Timpani
	XG Celesta
	XG Glockenspiel
	XG MusicBox
2	XG Orgel
	XG Vibraphone
	XG VibesKSP
	XG HardVibes
	XG Marimba
	XG MarimbaKSP
	XG SineMarimba
	XG Balimba
	XG LogDrums
	XG Xylophone
	XG TubularBells
	XG ChurchBells
	XG Carillon
	XG Dulcimer
	XG Dulcimer2
	XG Cimbalom
3	XG Santur
ORGAN	
1	Cool!Organ
	Cool!JazzOrgan
	Cool!RotorOrgan
	Cool!FullRocker
	StadiumOrgan
	RotaryDrive
	PercOrgan
	RockOrgan1
	DanceOrgan
	GospelOrg
	DrawbarOrgan1
	JazzOrgan1
	RockOrgan2
	PurpleOrgan
	ElectricOrgan
	DrawbarOrgan2
2	JazzOrgan2
	RockOrgan3
	ClickOrgan
	MellowDraw
	BrightDraw
	60'sOrgan
	JazzOrgan3
	Tibia 16+4
	TibiaFull
	Tibia 8+4
	Tibia 8
	Kinura 8
	Vox 8
	Thtr.Trp. 8
	Thtr.Trp. 16+8
	Tibia+Vox

3	Trp.+Kinura
	ChapelOrgan1
	ChapelOrgan2
	ChapelOrgan3
	PipeOrgan
	ReedOrgan
	Musette
	TuttiAccrd
	SmallAccrd
	Accordion
	TangoAccrd
	Steirisch
	Bandoneon
	SoftAccordion
	Sweet!Harmonica
	ModernHarp
4	BluesHarp
	XG DrawbarOrgan
	XG DetunedDrawOrg
	XG 60'sDrawOrg1
	XG 60'sDrawOrg2
	XG 70'sDrawOrg1
	XG DrawbarOrgan2
	XG 60'sDrawOrg3
	XG EvenBarOrg
	XG 16+2'2_3Org
	XG OrganBass
	XG 70'sDrawOrg2
	XG CheezyOrgan
	XG DrawbarOrgan3
	XG Perc.Organ
	XG 70'sPercOrg1
5	XG Det.Perc.Org
	XG LightOrgan
	XG Perc.Organ2
	XG RockOrgan
	XG RotaryOrgan
	XG SlowRotary
	XG FastRotary
	XG ChurchOrgan
	XG ChurchOrgan3
	XG ChurchOrgan2
	XG NotreDame
	XG OrganFlute
	XG Trem.OrganFl
	XG ReedOrgan
	XG PuffOrgan
	XG Accordion
6	XG AccordIt
	XG Harmonica
	XG Harmonica2
	XG TangoAccord
	XG TangoAccord2
GUITAR	
1	Live!NylonGuitar
	Cool!JazzGuitar
	Cool!El.Guitar
	Live!SteelGuitar
	Live!DynoSteel1
	Sweet!Mandolin
	Cool!FunkGuitar
	Cool!Stratsphere
	Cool!VintageLead
	Cool!PowerLead
	Cool!BluesGuitar
	RockGuitar
	VintageStrum
	Live!12StrGuitar
	Live!DynoSteel2
	Cool!CleanGuitar

2	VoodooLead
	PowerChord
	CampfireGuitar
	SolidGuitar
	VintageAmp
	AlohaGuitar
	CrunchGuitar
	SmoothLead
	60'sClean
	Live!ClassicGtr
	Cool!JazzSoloGtr
	VintageOpen
	FolkGuitar
	SolidChord
	VintageMute
	PedalSteel
3	LeadGuitar
	ChorusGuitar
	VintageTrem
	OctaveGuitar
	DeepChorus
	TremoloGuitar
	HeavyStack
	BrightClean
	WahGuitar
	DXJazzGuitar
	Distortion
	El. 12StrGuitar
	FeedbackGuitar
	18StringGuitar
	MutedGuitar
	FunkGuitar
4	Overdrive
	Mega SteelGuitar
	Mega HiStrGuitar
	Mega 12StrGuitar
	Mega CleanGuitar
	Mega Overdrive
	Mega Distortion
	XG NylonGuitar
	XG NylonGuitar2
	XG NylonGuitar3
	XG Vel.GtrHarmo
	XG Ukulele
	XG SteelGuitar
	XG SteelGuitar2
	XG 12StrGuitar
	XG Nylon&Steel
5	XG Steel&Body
	XG Mandolin
	XG JazzGuitar
	XG MellowGuitar
	XG JazzAmp
	XG CleanGuitar
	XG ChorusGuitar
	XG MutedGuitar
	XG FunkGuitar1
	XG MuteSteelGtr
	XG FunkGuitar2
	XG JazzMan
	XG Overdriven
	XG GuitarPinch
	XG Distortion
	XG FeedbackGtr
6	XG FeedbackGtr2
	XG GtrHarmonics
	XG GtrFeedback
	XG GtrHarmonics2

BASS	
1	Cool!FingerBass
	AcousticBass
	Cool!DynoPick
	Cool!Fretless
	SlapBass
	SubBass
	HardBass
	ResoBass
	HouseBass
	BigDroneBass
	RockBass
	SuperFretles
	PickBass
	FusionBass
Bass&Cymbal	
AnalogBass	
2	DXFunkBass
	DrySynBass
	80'sSynBass
	HiQBass
	FunkBass
	MellowFinger
	ClickBass
	PunchyBass
	TBBass
	Mega Aco.Bass
	Mega FingerBass
	Mega PickBass
	Mega Fretless
	XG AcousticBass
	XG JazzRhythm
	XG VXUprghtBass
	3
XG FingerDark	
XG FlangeBass	
XG Bass&DistEG	
XG FingerSlap	
XG FingerBass2	
XG ModulatedBass	
XG PickBass	
XG MutePickBass	
XG FretlessBass	
XG FretlessBass2	
XG FretlessBass3	
XG FretlessBass4	
XG Syn.Fretless	
XG SmoothFretless	
XG SlapBass1	
4	XG ResonantSlap
	XG PunchThumb
	XG SlapBass2
	XG Vel.SwitchSlap
	XG SynthBass1
	XG SynBass1Dark
	XG FastResoBass
	XG AcidBass
	XG Clavi.Bass
	XG TechnoBass
	XG Orbiter
	XG SquareBass
	XG RubberBass
	XG Hammer
	XG SynthBass2
XG MellowSyBass	
5	XG SequencedBass
	XG ClickSynBass
	XG SynBass2Dark
	XG SmoothSyBass
	XG ModulrSyBass
	XG DXBass
	XG XWireBass

STRINGS	
1	Sweet!Violin
	Viola
	Cello
	Contrabass
	Harp
	Hackbrett
	Fiddle
	Banjo
	Sitar
	Koto
	Shamisen
2	SoloViolin
	TremoloStrings
	PizzicatoStrings
	XG Violin
	XG SlwAtkViolin
	XG Viola
	XG Cello
	XG Contrabass
	XG Trem. Strings
	XG SlwAtTremStr
XG SuspenseStr	
XG PizzicatoStr	
XG OrchestralHarp	
XG YangChin	

ENSEMBLE	
1	Live!Strings
	Live!Allegro
	Live!Orchestra
	Symphon.Str
	OberStrings
	OrchestraHorns
	OrchestraFlute
	OrchestraOboe
	Tutti
	Strings
	Orch.Strings
	StringsQuartet
	ConcertStrings
	AnalogStrings
ChamberStrings	
BowStrings	
2	SlowStrings
	MarcatoStrings
	SynStrings1
	SynStrings2
	OrchestraHit
	Live!Gospel
	Live!Humm
	HahChoir
	SweetHeaven
	DreamHeaven
	Live!Mmh
	GothicVox
	Sunbeam
	BellHeaven
PanHeaven	
ProHeaven	
3	Choir
	AirChoir
	VoxHumana
	Voices
	UuhChoir
	XG Timpani
	XG Strings1
	XG StereoStrings
	XG SlwAtkStrings
	XG ArcoStrings
	XG 60'sStrings
	XG Orchestra
	XG Orchestra2
	XG TremOrchestra
XG Vel.Strings	
XG Strings2	
4	XG S.SlowStrings
	XG LegatoStrings
	XG WarmStrings
	XG Kingdom
	XG 70'sStrings
	XG Strings3
	XG SynStrings1
	XG ResoStrings
	XG SynStrings4
	XG SynStrings5
	XG SynStrings2
	XG ChoirAahs
	XG StereoChoir
	XG ChoirAahs2
XG MellowChoir	
XG ChoirStrings	
5	XG VoiceOohs
	XG SynthVoice
	XG SynthVoice2
	XG Choral
	XG AnalogVoice
	XG OrchestraHit
	XG OrchestraHit2
XG Impact	

BRASS	
1	Sweet!Trumpet
	Sweet!Trombone
	Sweet!MutedTrp.
	Sweet!FlugelHorn
	JazzTrumpet
	SoloTrumpet
	Trombone
	SoloTrombone
	SoftTrombone
	MellowTrombone
	MutedTrombone
	BaritonHorn
	BaritonHit
	AlpBass
FlugelHorn	
Tuba	
2	Live!HyperBrass
	Live!PopBrass
	Live!OctaveBrass
	Live!FrenchHorns
	Live!Synph.Horns
	BrassCombo
	BrassSection
	BreathBrass
	HybridCompBrass
	NaturalBrass
	Sforzando
	BigBrass
	BallroomBrass
	BrightBrass
MellowBrass	
HybriHorn	
3	HybriPad
	SoftVel.Brass
	80'sBrass
	SoftBrass
	FullHorns
	SmoothTrombone
	HighBrass
	OberBrass
	TrumpetEns
	MellowHorns
	BigBandBrass
	PopBrass
	BrassHit
	AnalogBrass
TromboneSection	
SmallBrass	
4	SoftAnalog
	FunkyAnalog
	TechnoBrass
	SynthBrass
	OberHorns
	FatSynBrass
	XG Trumpet
	XG Trumpet2
	XG BriteTrumpet
	XG WarmTrumpet
	XG Trombone
	XG Trombone2
	XG Tuba
	XG Tuba2
XG MutedTrumpet	
XG FrenchHorn	
5	XG FrenchHornSolo
	XG FrenchHorn2
	XG HornOrchestra
	XG BrassSection
	XG Tp&TbSection
	XG BrassSection2
	XG HighBrass
	XG MellowBrass
	XG SynthBrass1
	XG QuackBrass
	XG ResoSynBrass
	XG PolyBrass
	XG SynthBrass3
	XG JumpBrass
XG AnaVel.Brass1	
XG AnalogBrass1	

6	XG SynthBrass2
	XG SoftBrass
	XG SynthBrass4
	XG ChoirBrass
	XG AnaVel.Brass2
	XG AnalogBrass2
REED	
1	Sweet!TenorSax
	Sweet!AltoSax
	Sweet!SopranoSax
	GrowlSax
	BaritoneSax
	Live!SaxSection
	Saxappeal
	MoonLight
	BalladBrass
	SaxyMood
	SopranoSax
	TenorSax
	AltoSax
	SaxStack
	Live!SaxSect.Sft
	Live!SaxSect.Hrd
2	WoodwindEns
	Sweet!Clarinet
	Sweet!Oboe
	EnglishHorn
	Bassoon
	Clarinet
	Oboe
	XG SopranoSax
	XG AltoSax
	XG SaxSection
	XG HyperAltoSax
	XG TenorSax
	XG BreathyTenor
	XG SoftTenorSax
	XG TenorSax2
	XG BaritoneSax
3	XG Oboe
	XG EnglishHorn
	XG Bassoon
	XG Clarinet
PIPE	
1	Sweet!Flute
	Sweet!PanFlute
	FluteEnsemble
	Flute
	PanFlute
	ClassicalFlute
	Piccolo
	EthnicFlute
	Shakuhachi
	Whistle
	Recorder
	Ocarina
	XG Piccolo
	XG Flute
	XG Recorder
	XG PanFlute
2	XG BlownBottle
	XG Shakuhachi
	XG Whistle
	XG Ocarina

SYNTH LEAD	
1	Oxygen
	Matrix
	WireLead
	HipLead
	HopLead
	DanceHook
	TechLead
	Tekkline
	SoftMini
	OctaveHook
	TranceLead
	FireWire
	Analogon
	Blaster
	Skyline
	SquareLead
2	SawtoothLead
	PopLead
	ProLead
	BrightMini
	TinyLead
	FunkyLead
	Paraglide
	Robolead
	Fargo
	Portatone
	BigLead
	Warp
	Adrenaline
	Stardust
	AeroLead
	MiniLead
3	Impact
	SunBell
	UnderHeim
	HiBias
	Vinylead
	PanLead
	Stringbells
	CrystalEyes
	Padbells
	MelodyMaker
	BigTune
	TrumpetSaw
	AttackSaw
	PercSquare
	XG SquareLead
	XG SquareLead2
4	XG LMSquare
	XG Hollow
	XG Shroud
	XG Mellow
	XG SoloSine
	XG SineLead
	XG SawtoothLead
	XG SawtoothLead2
	XG ThickSaw
	XG DynamicSaw
	XG DigitalSaw
	XG BigLead
	XG HeavySynth
	XG WaspySynth
	XG PulseSaw
	XG Dr.Lead
5	XG VelocityLead
	XG Seq.Analog
	XG CalliopeLead
	XG PurePad
	XG ChiffLead
	XG Rubby
	XG CharangLead
	XG DistortedLead
	XG WireLead
	XG VoiceLead
	XG SynthAahs
	XG VoxLead
	XG FifthsLead
	XG BigFive
	XG Bass&Lead
	XG Big&Low
6	XG Fat&Perky
	XG SoftWhirl

SYNTH PAD	
1	Insomnia
	Skydiver
	Bubblespace
	HipaStringPad
	MellowPad
	Mediterrain
	NeoWarmPad
	CyberPad
	OberSweep
	Messenger
	Wave2001
	FarEast
	Disclosure
	BrightOber
	DarkPad
	Mystery
2	Sirius
	S&HGroove
	Velo.Ashrami
	EveningStars
	AngelVibes
	Atmosphere
	XenonPad
	Equinox
	GlassPad
	Fantasia
	DX Pad
	Symbiont
	Stargate
	Area51
	DarkMoon
	Ionosphere
3	GoldenAge
	Solaris
	TimeTravel
	Millennium
	Dunes
	XG NewAgePad
	XG Fantasy
	XG WarmPad
	XG ThickPad
	XG SoftPad
	XG SinePad
	XG HornPad
	XG RotaryStrings
	XG PolySynthPad
	XG PolyPad80
	XG ClickPad
4	XG AnalogPad
	XG SquarePad
	XG ChoirPad
	XG Heaven
	XG Itopia
	XG CCPad
	XG BowedPad
	XG Glacier
	XG GlassPad
	XG MetallicPad
	XG TinePad
	XG PanPad
	XG HaloPad
	XG SweepPad
	XG Shwimmer
	XG Converge
5	XG PolarPad
	XG Celestial

SYNTH EFFECTS	
1	XG Rain
	XG Clavi.Pad
	XG HarmoRain
	XG AfricanWind
	XG Carib
	XG SoundTrack
	XG Prologue
	XG Ancestral
	XG Crystal
	XG SynthDr.Comp
	XG Popcorn
	XG TinyBells
	XG RoundGlocken
	XG GlockenChime
	XG ClearBells
	XG ChorusBells
2	XG SynthMallet
	XG SoftCrystal
	XG LoudGlocken
	XG ChristmasBel
	XG VibeBells
	XG DigitalBells
	XG AirBells
	XG BellHarp
	XG Gamelimba
	XG Atmosphere
	XG WarmAtmos.
	XG HollowRelease
	XG NylonEl.Piano
	XG NylonHarp
	XG HarpVox
	XG Atmos.Pad
3	XG Planet
	XG Brightness
	XG FantasyBells
	XG Smokey
	XG Goblins
	XG GoblinsSynth
	XG Creeper
	XG RingPad
	XG Ritual
	XG ToHeaven
	XG Night
	XG Glisten
	XG BellChoir
	XG Echoes
	XG Echoes2
	XG EchoPan
4	XG EchoBells
	XG BigPan
	XG SynthPiano
	XG Creation
	XG StarDust
	XG Reso&Panning
	XG Sci-Fi
	XG Starz

ETHNIC		
1	Bagpipe	
	XG Sitar	
	XG DetunedSitar	
	XG Sitar2	
	XG Tambra	
	XG Tamboura	
	XG Banjo	
	XG MutedBanjo	
	XG Rabab	
	XG Gopichant	
	XG Oud	
	XG Shamisen	
	XG Koto	
	XG Taisho-kin	
	XG Kanoon	
	XG Kalimba	
	2	XG Bagpipe
XG Fiddle		
XG Shanai		
XG Shanai2		
XG Pungi		
XG Hichiriki		
XG TinkleBell		
XG Bonang		
XG Altair		
XG GamelanGongs		
XG StereoGamelan		
XG RamaCymbal		
XG AsianBells		
PERCUSSION		
1	XG Agogo	
	XG SteelDrums	
	XG GlassPerc.	
	XG ThaiBells	
	XG Woodblock	
	XG Castanets	
	XG TaikoDrum	
	XG GranCassa	
	XG MelodicTom	
	XG MelodicTom2	
	XG RealTom	
	XG RockTom	
	XG SynthDrum	
	XG AnalogTom	
	XG ElectroPerc.	
	XG Rev.Cymbal	
SOUND EFFECTS		
1	XG GtrFretNoise	
	XG BreathNoise	
	XG Seashore	
	XG BirdTweet	
	XG TelephoneRing	
	XG Helicopter	
	XG Applause	
	XG Gunshot	
	XG CuttingNoise	
	XG CuttingNoise2	
	XG StringSlap	
	XG Fl.KeyClick	
	XG Shower	
	XG Thunder	
	XG Wind	
	XG Stream	
	2	XG Bubble
		XG Feed
		XG Dog
		XG Horse
XG BirdTweet2		
XG Ghost		
XG Maou		
XG PhoneCall		
XG DoorSqueak		
XG DoorSlam		
XG ScratchCut		
XG ScratchSplit		
XG WindChime		
XG TelephoneRing2		
XG CarEngineIgn		
XG CarTiresSql		

3	XG CarPassing
	XG CarCrash
	XG Siren
	XG Train
	XG JetPlane
	XG Starship
	XG Burst
	XG RollrCoaster
	XG Submarine
	XG Laugh
	XG Scream
	XG Punch
	XG Heartbeat
XG FootSteps	
XG MachineGun	
XG LaserGun	
4	XG Explosion
	XG Firework

3 Rhythm Sequence Program

With the Rhythm Sequence Program function, you can string together any of the DDK-7's existing rhythms and the rhythms of your own creation together to make complete rhythm compositions.

You can save four rhythm compositions (each can contain up to 140 bars) to the Sequence buttons on the panel for future recall. Two or more rhythm compositions can be played back in succession, letting you divide a song into parts and play back the rhythm data as desired. Here are a couple of example applications:

- When you want to play more than two songs in a medley, save the rhythm composition for each song to a separate sequence button. You can then recall each desired song by simply pressing the corresponding sequence button to which the song is saved.
- When you want to practice a song in separate sections (for example, separately practicing the verse, chorus and bridge), divide the song into the relevant parts. For example, save the intro part to the [SEQ. 1] button, the main chorus part to the [SEQ. 2] button, the ending to the [SEQ. 3] button, and so on. Then, recall the desired part simply by pressing the appropriate sequence button. You can also play through a song by recalling all the parts in sequence.

Selecting a Sequence

There are two ways to program a rhythm sequence: copying an existing sequence that is similar to the sequence you want to create, or creating your own sequence from scratch.

- 1 Press the [PROGRAM] button in the DISPLAY SELECT section.

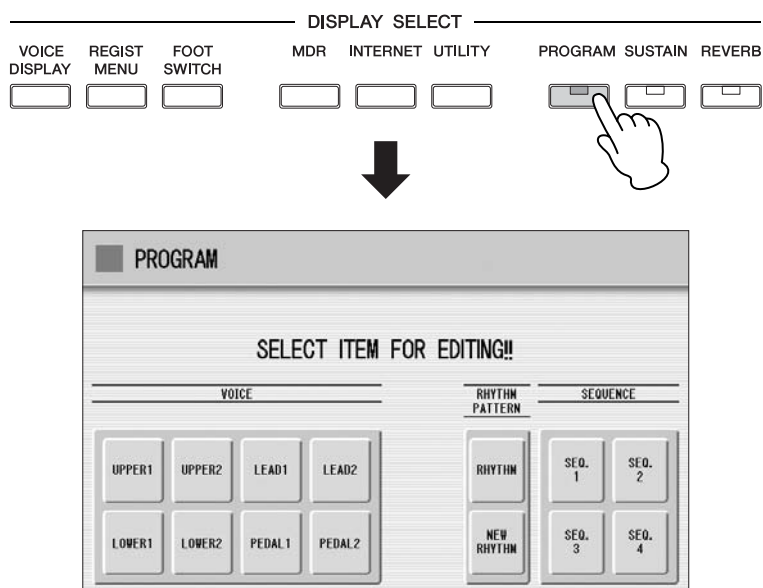

Any rhythm currently playing will automatically be stopped when you call up the Rhythm Sequence Program function.

2 Press one of the Sequence buttons ([SEQ. 1] – [SEQ. 4]) in the display to select the rhythm sequence number you want to edit.

The lamp of the selected numbered sequence button in the Rhythm section lights, and the Sequence Display appears.

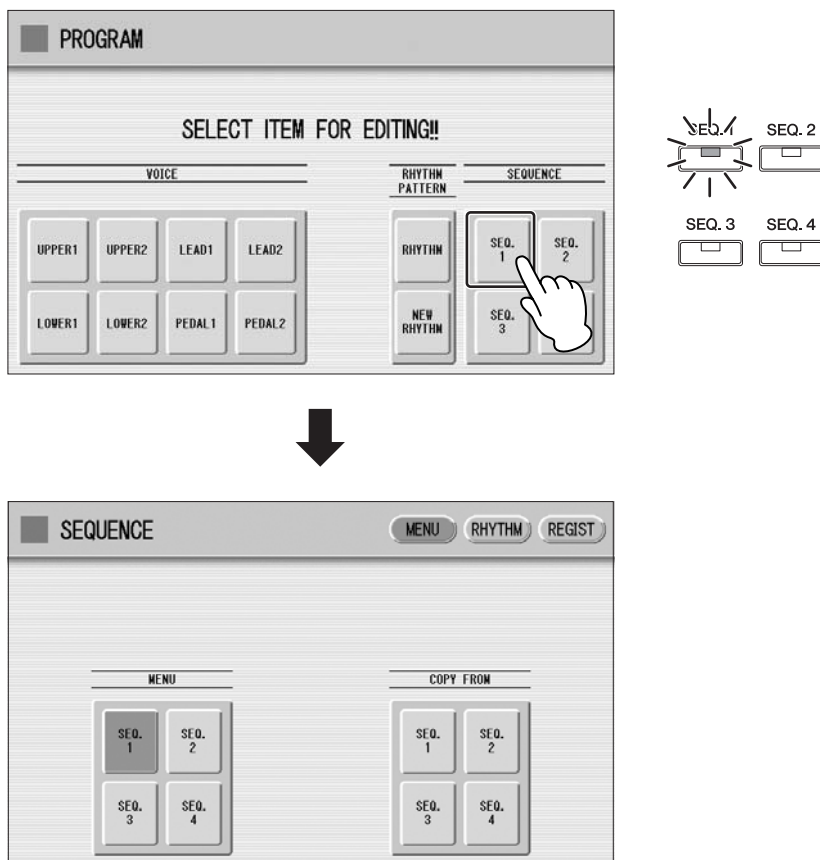

Instead of pressing the Sequence button on the Program display, you can press one of the sequence buttons on the Sequence display, or you can press the Sequence buttons in the Rhythm section on the panel to select the sequence number.

This selects the Sequence number, to which a rhythm composition can be saved. If you want to copy a rhythm composition from another Sequence number, go on to the next step.

3 Press the Sequence button ([SEQ. 1] – [SEQ. 4]) of the copy source on the right half in the display.

A message appears, prompting confirmation of the operation.

4 Press [COPY] to execute the operation, or select [CANCEL] to abort the operation.

Programming a Sequence

- 1 Press the [RHYTHM] button at the top right of the display to call up the RHYTHM Page.
- 2 Press the [CATEGORY] button to call up the Rhythm Category Select pop-up menu, then select the Rhythm category corresponding to the rhythm you want to enter to the sequence. If you press User category button, you can select a rhythm of your own creation (User rhythm).

The rhythm menu of the selected rhythm category is displayed.



- 3 Select the desired rhythm from the displayed rhythm menu.

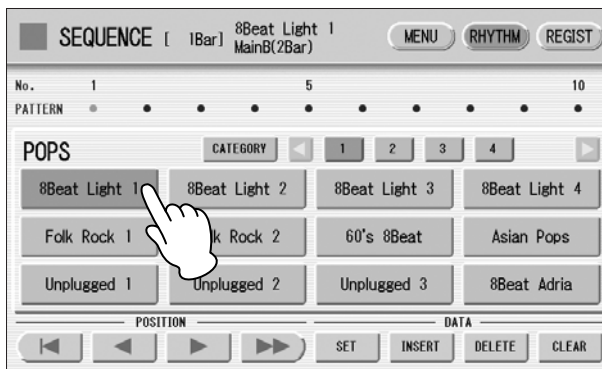

- 4 Select a rhythm section (Main A – D, Fill in A – D, Intro 1 – 3, Ending 1 – 3, or Break) by pressing one of the rhythm control buttons on the panel.

The selected rhythm and section appears at the top of the display.

- 5 Press the [SET] button in the display.

One bar of the selected rhythm is entered and its name is displayed as a box in the rhythm row on the display. When the rhythm is entered, the cursor (colored orange) will automatically move to one step right. A maximum of 140 bars can be entered to a single sequence. When you select an ending pattern and press the [SET] button, an entire ending pattern (more than one bar) is entered. You cannot enter a rhythm after an ending pattern.



NOTE

When entering an Intro section, check the number of bars at the top of the display.

6 Repeat steps #2 through #5 above to enter the rhythm and create your own rhythm composition.

Turning the power off before quitting or closing the Rhythm Sequence Program erases any sequences you have made. Before turning the power off, quit the Rhythm Sequence Program (page 190).

Auditioning a Sequence

You can play a sequence you are editing at any time to audition the changes.

- 1 Move the cursor to the desired position for playback.**
Move the cursor by using the Data Control dial, or the POSITION buttons on the display.

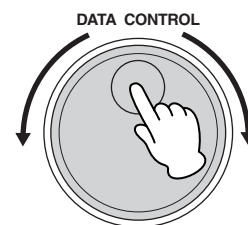
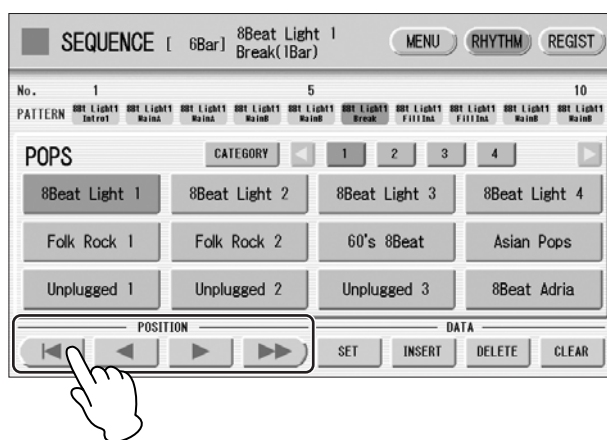

- 2 Press the rhythm [START] button on the panel.**

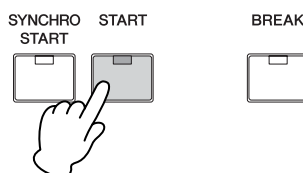

The Sequence plays back. Pressing the [START] button again stops playback.



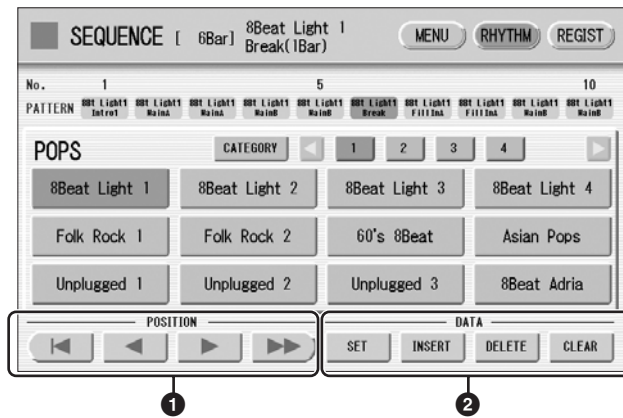

Editing an Existing Rhythm Sequence

You can insert a new rhythm between the rhythms you have already entered, or delete the entered rhythm from the sequence.



1 POSITION

These are cursor controls for moving the cursor (colored orange) along the rhythm row in the display.

-  Moves the cursor to the first position.
-  Moves the cursor one step to the left.
-  Moves the cursor one step to the right.
-  Moves the cursor five steps to the right.

2 DATA

These are data controls for entering rhythms and deleting existing rhythms in the rhythm row.

SET

For initially entering a rhythm to an empty position in the rhythm row, or for replacing a pattern at the cursor position. Pressing the [SET] button enters the rhythm selected from the rhythm menu to the cursor position. This operation is not available between measures of an ending pattern.

INSERT

For inserting a rhythm before the current cursor position. The new rhythm is entered just before the cursor position and all other rhythms to the right of the cursor are moved to accommodate the new number. This operation is not available between measures of an ending pattern. Additional rhythms cannot be entered beyond the Rhythm sequence function's capacity of 140. If the Insert operation results in the rhythm number going over the capacity, a "Data Full" message appears and the operation cannot be executed.

DELETE

For deleting a rhythm at the current cursor position. When the ending pattern is selected, pressing the [DELETE] button deletes the entire ending pattern (more than one bar).

CLEAR

For erasing all patterns entered to the selected sequence. After selecting [CLEAR], a message appears prompting confirmation of the operation. Select [CLEAR] to clear the currently selected rhythm sequence, or select [CANCEL] to abort the operation and return to the previous display.



When you insert an ending pattern into the editing sequence, any existing rhythm data that follows an Ending pattern is automatically deleted.

Programming a Registration Sequence



NOTE

If you are loading a Registration while a rhythm is playing, the sequence data and User rhythms in the Registration data cannot be loaded.

The Registration Sequence feature allows you to have desired Registrations automatically called up in sequence, when playing a Rhythm Sequence. It lets you program the timing (bar/beat/clock) at which the Registration is changed. You can also program the Next Regist function in Registration Sequence.

A Registration Sequence is saved as a part of the corresponding Rhythm Sequence. With this feature, you can have the sounds of the instrument change as desired automatically to match the Rhythm Sequence playback.

- 1 Press the [REGIST] button at the top right in the display to call up the Registration Sequence display.

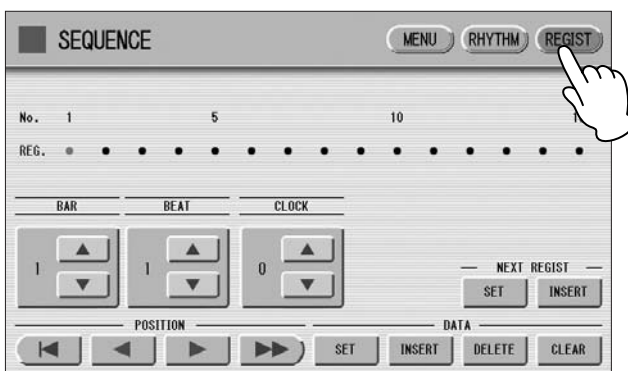

The Registration Sequence is programmed from this display. The entered Registration number is shown along the Registration row in the middle of the display.

- 2 Press the desired numbered button in the Registration Memory section.

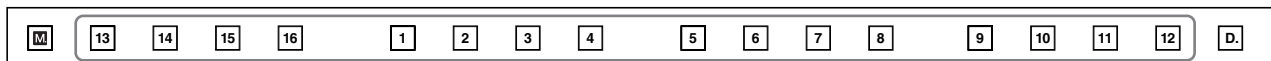

- 3 Using the ▲ ▼ buttons in the display or the Data Control dial, set the Bar/Beat/Clock position at which you want to change the Registration (1 beat = 96 Clock).

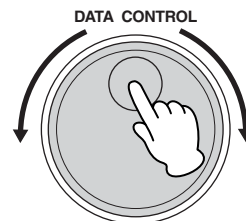
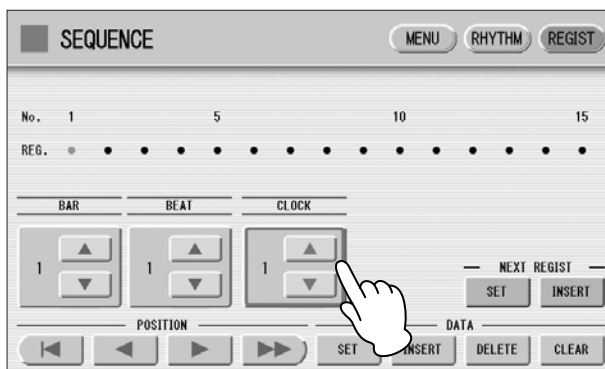

When using the Data Control dial, first press the number you wish to change in the display, then turn the dial.



- 4 Press the DATA [SET] button in the display.**

The Registration number appears in the display (in the timing order), indicating that the Registration is entered. Up to 140 Registrations can be entered. If some Registration numbers are entered to the same Bar/Beat/Clock, the last entered one takes priority.

- 5 Repeat steps #2 through #4 above to set the Registration Sequence.**

Entering Next Regist:

When you program the Next Regist function in Registration Sequence, the next registration data in current song can be loaded automatically just by playing the rhythm sequence.

- 1 Using the   buttons in the display or the Data Control dial, set the Bar/Beat/Clock position at which you want to enter the Next Regist (1 beat = 96 clock).**
- 2 Press the NEXT REGIST [INSERT] button in the display.**

The Next Regist mark  appears at the timing point you set in step #1, indicating that the Next Regist is entered.

Next Regist Loading Time

- Loading Next Regist may take a few seconds (the time may differ depending on the size of the data to be loaded).
- When using a floppy disk instead of USB flash memory, the loading time will be longer than when using USB flash memory.
- Next Registration data can be loaded by two ways: using optional foot pedal/right footswitch and programming Next Regist in the Registration Sequence. Loading time is the same regardless of which way you load the Next Registration data.

Editing an Existing Registration Sequence

You can move or delete the entered Registration Sequence (Registration number or Next Regist data) from the sequence.

To move an entry:

- 1 Using the POSITION buttons, move the cursor and select the data (Registration number or Next Regist) you want to move.**
- 2 Change the position by pressing the Bar/Beat/Clock buttons in the display.**

- 3 To move the Registration number timing, press the DATA [SET] button. To move the Next Regist timing, press the NEXT REGIST [SET] button.**

The position of the Registration number or Next Regist is changed and displayed in the proper order.

To erase an entry:

- 1 Using the POSITION buttons, move the cursor and select the data (Registration number or Next Regist) you want to delete.**
- 2 Press the [DELETE] button to delete the data.**

Quitting the Rhythm Sequence Program

You can quit the Rhythm Sequence Program from any of its display pages. When you quit, the sequence you have made will be automatically saved.

To quit the Rhythm Sequence Program:

Press the [PROGRAM] button on the panel.

The Voice Display appears, indicating that the Rhythm Sequence Program is closed.



When quitting the Rhythm Sequence Program, the square at the top left of the display turns light blue for a few seconds, indicating that the sequence is currently being saved. Do not turn the power off while the sequence is being saved.

Playing Rhythm Sequences

To play any of the rhythm sequences you have created:

- 1 Press the appropriate Sequence button ([SEQ. 1] – [SEQ. 4]) on the panel.**

The SEQ button's lamp lights.

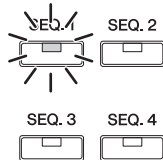

- 2 Press the rhythm [START] button.**

The rhythm in the selected sequence starts playback.

The Registration Memory also changes with the Rhythm Sequence playback, if the sequence includes a Registration Sequence.

Rhythm playback automatically stops when the sequence reaches its end.

If you've stopped rhythm playback in the middle of the sequence, press the [START] button again to resume playback.

Playing All Sequences in Order

You can also have up to all four rhythm sequences automatically play in order, one after another.

- 1 Press the desired Sequence buttons, making sure that all their LEDs are lit.**

- 2 Press the rhythm [START] button.**

The rhythm sequences start from the lowest number and play in order automatically to the highest number. (For example, if you press Sequence buttons 4, 2 and 1 in that order, the sequences will be played back not in the order you pressed them, but in their numeric order: 1, 2, then 4.) This function effectively allows you to make a long rhythm sequence that exceeds the 140-pattern memory limit of a single sequence.

Pressing one of the SEQ. buttons while a Rhythm Sequence is playing back automatically cancels the pressed sequence, and its LED turns off. You cannot cancel a sequence that is currently playing. The SEQ. lamp goes out when the sequence assigned to it is finished playing.



Reference Page

Connecting a pedal unit
(page 229)
Footswitches (page 193)

To start a sequence using the Left Footswitch:

You can start or stop the Rhythm Sequence playback using the left footswitch. To use the left footswitch, pedal unit must be connected to the DDK-7.

- 1 Press the desired Sequence buttons, making sure that all their LEDs are lit.**
- 2 Press the [FOOT SWITCH] button on the panel to call up the Footswitch display, LEFT Page.**
- 3 Set the control mode of the Footswitch to RHYTHM STOP.**
(See page 193 for information about the Footswitch settings.)
- 4 Press the Left Footswitch with your right foot to turn the sequence on.**

Pressing the Left Footswitch again in the middle of the sequence playback cancels the Rhythm Sequence.

When you are playing a Rhythm Sequence that is made up of several sequences (SEQ. buttons), pressing the Left footswitch turns off the currently playing Rhythm Sequence, and pressing it again starts the next sequence.

You can also start the Rhythm Sequence playback using the optional foot pedal.



Reference Page

Connecting a foot pedal
(page 229)
Foot pedal (page 196)

4

Saving Rhythm Pattern and Rhythm Sequence Data to external media

You can save your own rhythm patterns (created in the Rhythm Pattern Program) and Rhythm Sequence (created in the Rhythm Sequence Program) to external media, such as USB flash memory. Refer to the section “Saving Registrations as Registration Data (File)” on page 116 for instructions.

When loading your original Rhythm data from external media back to the DDK-7, be sure to stop the rhythm if it is playing. Loading cannot be executed when a rhythm is running.

10 Controllers

These leg- and foot-operated controls allow you to execute various performance functions and switch the effect on/off, without taking your hands from the keyboard. In order to use these controllers, you'll need to connect the DDKU-P7 Pedal Unit or an optional FC4/5/7/9 Foot Pedal to the DDK-7.

Contents

1 Footswitches	193	• Controlling the Rhythm	201
• Controlling the Rhythm	194	• Controlling Glide	202
• Controlling Glide	195	• Controlling Rotary Speaker	202
• Controlling Rotary Speaker	196	• Controlling Registration Shift	203
2 Foot Pedal	196	• Controlling Expression	204
• Controlling Sustain	198	3 Expression Pedals	205
• Controlling Lead Slide	199	• Controlling Pitch Bend	206
• Controlling Melody On Chord	200	• Controlling the Rhythm Tempo	207
• Controlling the Solo Function	201		

1 Footswitches

To use the Footswitches, connect the Pedal Unit DDKU-P7 to the DDK-7.

The Pedal Unit DDKU-P7 has two Footswitches on the main expression pedal. The Right Footswitch is used for the Registration Shift function. The Left Footswitch can be set to control one of the following functions: Rhythm, Glide, and Rotary speaker. See page 94 for the details of the Registration Shift function or Right Footswitch. The explanation on the Left Footswitch is given here.



Reference Page

Connecting a pedal unit (page 229)

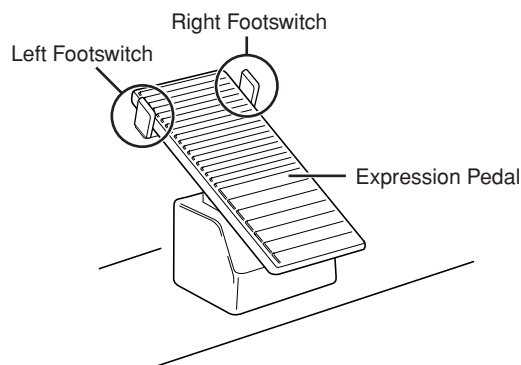

1 Press the [FOOT SWITCH] button.

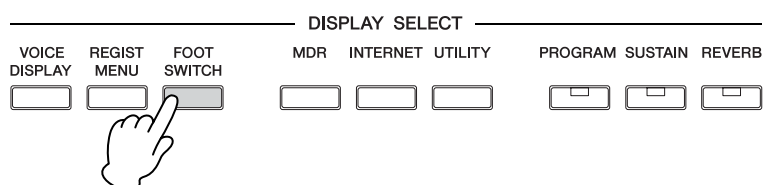

2 Press the [LEFT] button at the top right of the display to call up the LEFT Page.

FOOTSWITCH Display



In this display, you can assign the control function to the Left Footswitch: Rhythm, Glide, and Rotary Speaker.

If you choose OFF here, the Left Footswitch will not control any function.

Controlling the Rhythm

You can control the rhythm start/stop or switch the rhythm sections by using the Left Footswitch.

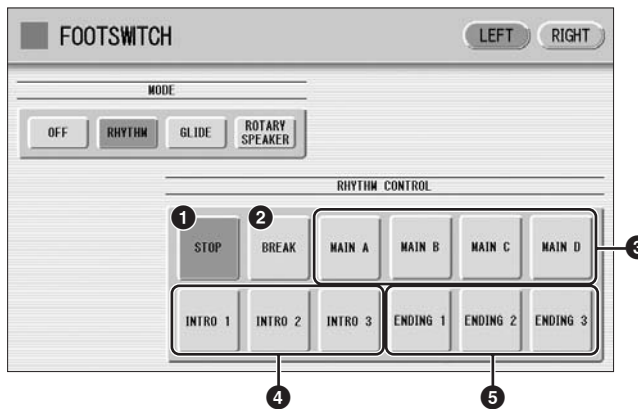

Reference Page

Rhythm Structure (page 62)

1 STOP

Switches the rhythm on/off whenever you press the Footswitch.

2 BREAK

When you press the Footswitch, the Break section turns on. This function corresponds to the [BREAK] button on the panel.

3 MAIN A – MAIN D

These functions correspond to the MAIN/FILL IN [A] – [D] buttons on the panel. For example, when the [MAIN A] button is selected in this display and you press the Footswitch, the rhythm section is switched to Main A or Fill In A.

4 INTRO 1 – INTRO 3

These functions correspond to the INTRO [1] – [3] buttons on the panel. For example, when the INTRO [1] button is selected in this display and you press the Footswitch, the rhythm section is switched to Intro 1.

5 ENDING 1 – ENDING 3

These functions correspond to the ENDING [1] – [3] buttons on the panel. For example, when the ENDING [1] button is selected in this display and you press the Footswitch, the rhythm section is switched to Ending 1. After the ending pattern is played, the rhythm stops.

You can also control the rhythm start/stop or switch the rhythm sections by using an optional Foot Pedal.



Reference Page

Foot pedal (page 196)

Controlling Glide

You can control the Glide effect by using the Left Footswitch.

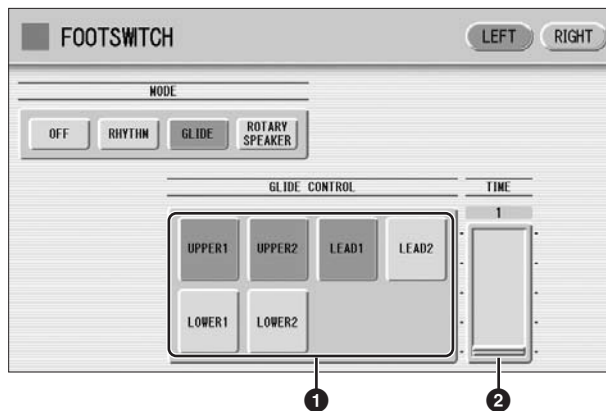

Pressing the Footswitch immediately lowers the pitch of the selected Voice or Voices by a half-step and releasing it slowly returns the pitch to the original.

1 Voice Selections (UPPER1/UPPER2/LEAD1/LEAD2/LOWER1/LOWER2)

Select the desired Voice section(s) to which the Glide function is to be applied.

2 TIME

Determines the speed of the Glide function, or in other words, how gradually the pitch returns when the Footswitch is released. Higher values make the speed slower.

Range: 1 – 5

You can also control the Glide effect by using an optional Foot Pedal.



Reference Page

Foot pedal (page 196)

Controlling Rotary Speaker



Reference Page

Rotary Speaker (page 50)

You can control the Rotary Speaker effect (on/off) by using the Left Footswitch.

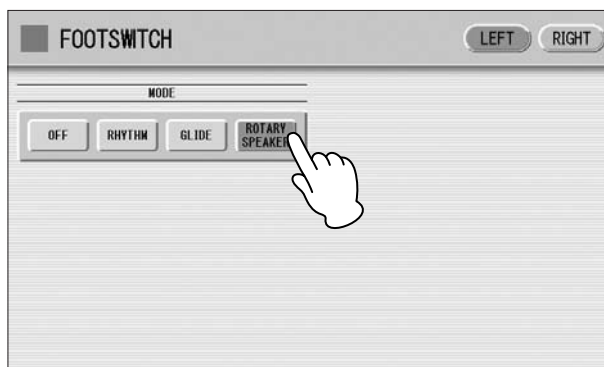

When the [Rotary Speaker] button is selected in this display and you press the Footswitch, the Rotary Speaker effect is switched on or off. This function corresponds to the [ROTARY SP SPEED] button on the panel. To use this function, you'll need to make the appropriate Rotary Speaker settings for each Voice section or Organ Flute Voice. For details, see page 50.



Reference Page

Foot pedal (page 196)

You can also control the Rotary Speaker effect (on/off) by using an optional Foot Pedal.

2 Foot Pedal

To use the Foot Pedal, you will need to connect an optional Foot Pedal (FC4/FC5/FC7/FC9) to the DDK-7. The Foot Pedal then can be used to turn one of the following functions on and off. Up to two Foot Pedals can be connected to the DDK-7. You can assign one function for each Foot Pedal in the FOOT PEDAL Page of the Utility display. Note that Some functions will need to be turned on or its parameters set beforehand.

Assignable Functions

Sustain	Lead Slide
Melody On Chord	Solo
Rhythm	Glide
Rotary Speaker	Registration Shift
Expression	

To control Expression, use the FC7/FC9. To control other functions, use the FC4/FC5.

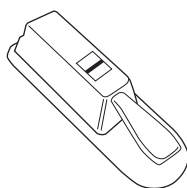

FC4

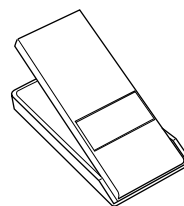

FC7

Assigning functions to a Foot Pedal:

1 Press the [UTILITY] button to call up the Utility display.

2 Press the [F.PEDAL] button at the top right of the display to call up the Foot Pedal Page.

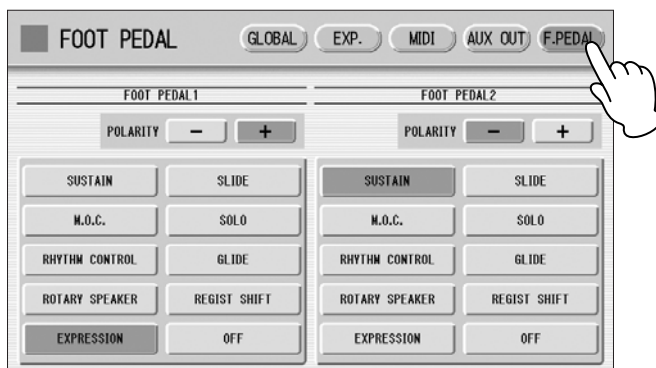

In this display, you can assign the control function to the Foot Pedal.

3 Select the control function to be assigned to the Foot Pedal.

Select the desired function button from the left side of the display if you've connected the Foot Pedal to the FOOT PEDAL (1 VOLUME) terminal; select from the right side if you've connected the Foot Pedal to the FOOT PEDAL (2 SUSTAIN) terminal.

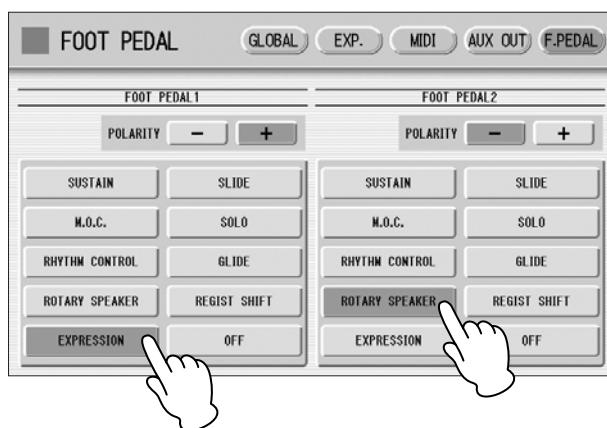

The polarity of the Foot Pedal will automatically be selected depending on the selected function; however, you can select the polarity manually.

4 The effect is constantly applied as long as the Foot Pedal is pressed.

Releasing the Foot Pedal turns the effect off.

Controlling Sustain

You can control the on/off status of Sustain for each Voice Section by using the Foot Pedal. Sustain for the Pedalboard cannot be controlled.



Reference Page

Sustain (page 49)

- 1 Press the [SUSTAIN] button to call up the Sustain display, then turn the desired Voice section on from the display.

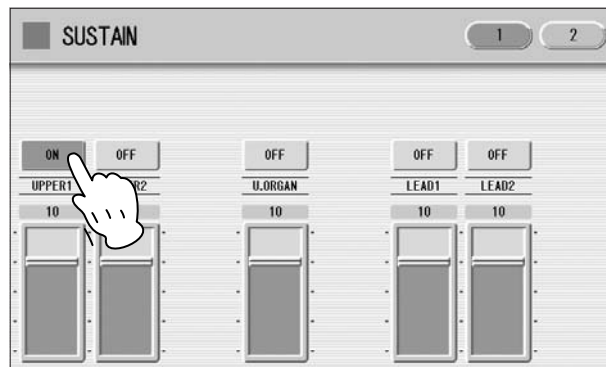
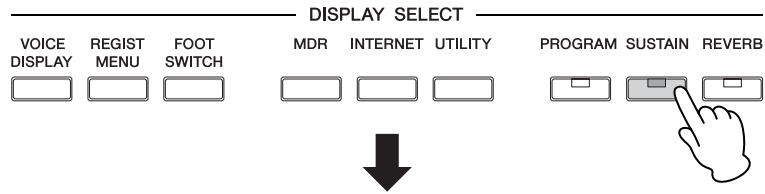

- 2 Select [SUSTAIN] in the FOOT PEDAL Page of the UTILITY display.

The Sustain function is now assigned to the Foot Pedal.

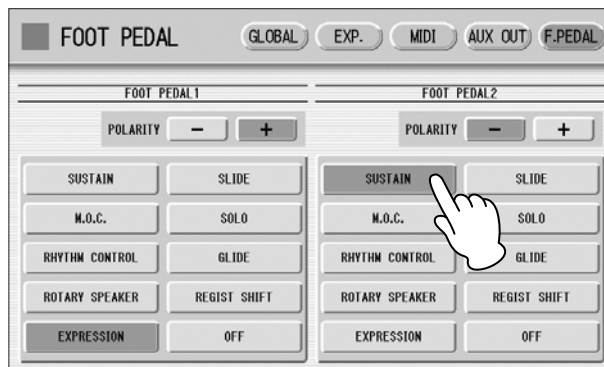

- 3 To apply sustain, press the Foot Pedal.

Sustain is constantly applied as long as the Foot Pedal is pressed. Releasing the Foot Pedal turns sustain off.

Controlling Lead Slide

- 1 Call up the Voice Condition display Page 2 of the Lead Voice section to which you want to apply the Lead Slide effect.



Reference Page

Voice Condition Display
(page 41)

- 2 Press the [ON] button of the Slide section on the display.

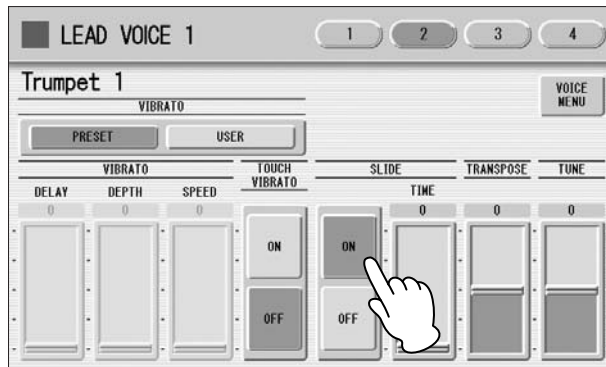

- 3 Select [SLIDE] in the FOOT PEDAL Page of the Utility display. The Slide effect function is now assigned to the Foot Pedal.

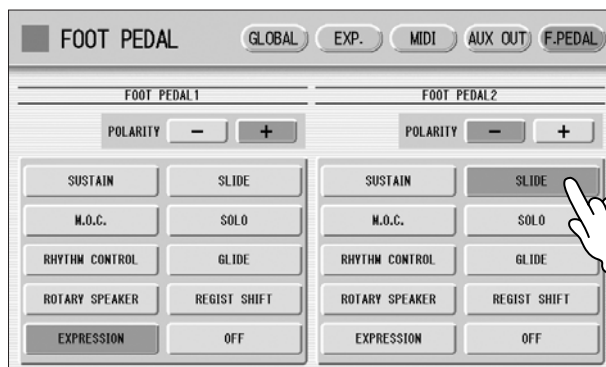

- 4 Press the Foot Pedal when you want to apply the Slide effect. The Slide effect is applied as long as the Foot Pedal is pressed. Releasing the Foot Pedal, cancels the Lead Slide effect.

Controlling Melody On Chord

1 Call up the Page 3 of the Voice Display.



Reference Page

Voice display (page 18)

VOICE Display [Page 3]

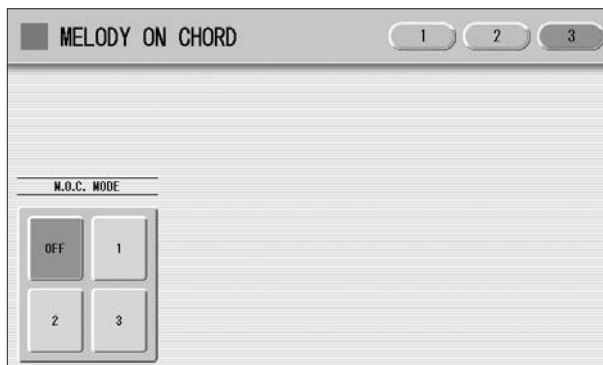

2 Select one of the modes.



Reference Page

Melody On Chord (page 73)

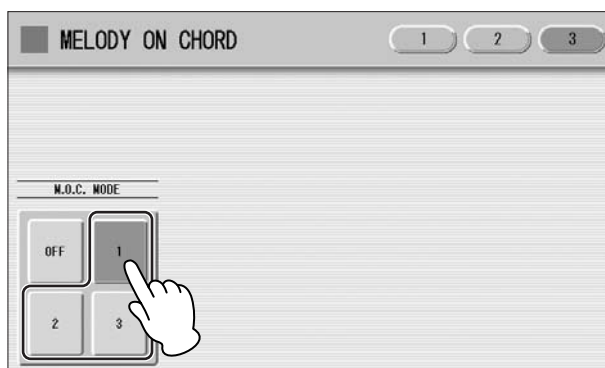

3 Select [M.O.C.] in the FOOT PEDAL Page of the Utility display.
The M.O.C. function is now assigned to the Foot Pedal.

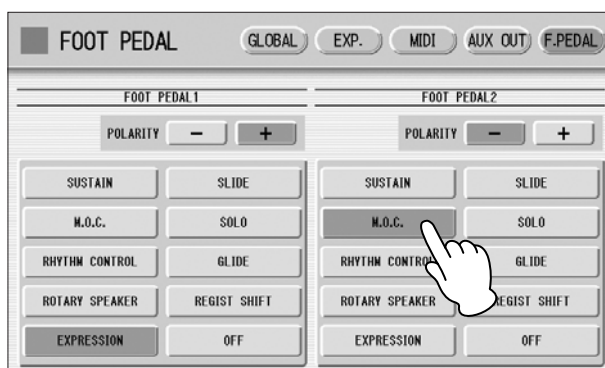

4 Press the Foot Pedal when you want to apply the M.O.C. effect.
The M.O.C. effect is applied constantly, as long as the Foot Pedal is pressed.
When you release the Foot Pedal, the M.O.C. effect is cancelled.

Controlling the Solo Function

You can turn the Solo function on/off by using the Foot Pedal. See page 30 for more information.

Controlling the Rhythm

You can control the rhythm start/stop or switch the rhythm sections not only by using the Left Footswitch, but also the Foot Pedal.



Reference Page

Footswitch Display
(page 194)

- 1 Set the rhythm settings in the LEFT Page of the Footswitch display.
- 2 Select [RHYTHM CONTROL] in the FOOT PEDAL Page of the Utility display.

The Rhythm Control function is now assigned to the Foot Pedal.

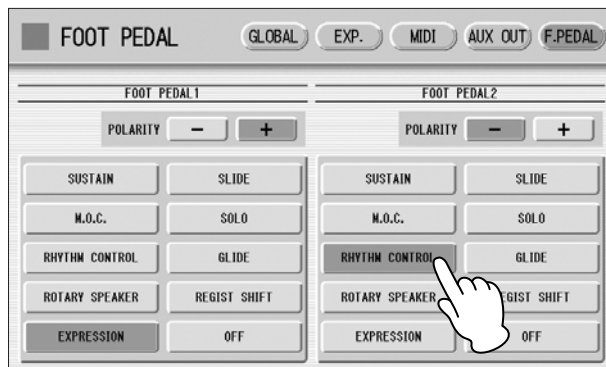

- 3 Press the Foot Pedal when you want to start/stop the rhythm or switch the rhythm sections.

Controlling Glide

You can control the Glide effect not only by using the Left Footswitch, but also the Foot Pedal.



Reference Page

Footswitch Display
(page 194)

- 1 Set the Glide settings in the LEFT Page of the Footswitch display.**
- 2 Select [GLIDE] in the FOOT PEDAL Page of the Utility display.**
The Glide Effect is now assigned to the Foot Pedal.

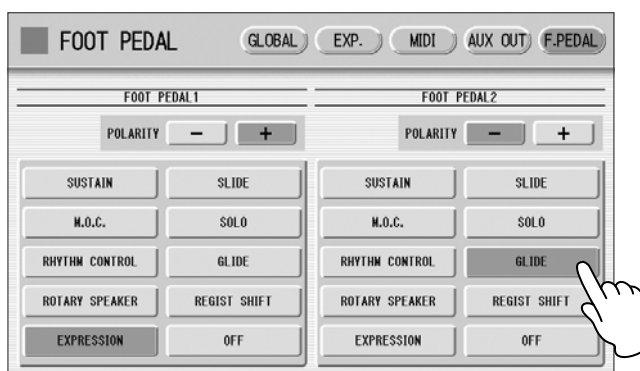

- 3 Pressing the Foot Pedal immediately lowers the pitch of the selected Voice or Voices by a half-step and releasing it slowly returns the pitch to the original.**

Controlling Rotary Speaker

You can control the Rotary Speaker effect (on/off) not only by using the Left Footswitch, but also the Foot Pedal.

- 1 Select [ROTARY SPEAKER] in the FOOT PEDAL Page of the Utility display.**
The Rotary Speaker function is now assigned to the Foot Pedal.

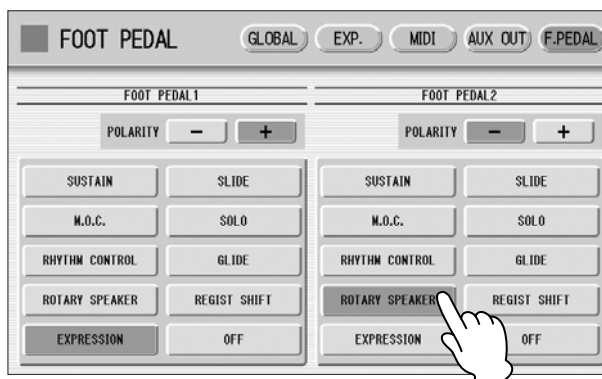

2 Press the Foot Pedal when you want to switch the Rotary Speaker effect on or off.

Pressing the Foot Pedal has the same effect as pressing the [ROTARY SP SPEED] button. To use this function, you will need to select the Rotary Speaker effect for the desired Voice. Refer to page 50.

Controlling Registration Shift

You can control Registration Shift not only by using the right Footswitch, but also the Foot Pedal.



Reference Page

Registration Shift (page 94)

1 Set the Registration Shift mode in the Regist Shift display.

2 Select [REGIST SHIFT] in the FOOT PEDAL Page of the UTILITY display.

The Registration Shift function is now assigned to the Foot Pedal.

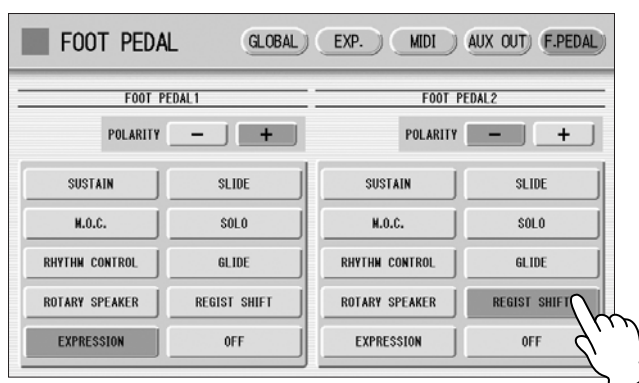

3 Press the Foot Pedal when you want to change Registrations.

Controlling Expression

You can control Expression not only by using the Expression Pedal, but also the Foot Pedal.

1 Select [EXPRESSION] in the FOOT PEDAL Page of the Utility display.

The Expression function is now assigned to the Foot Pedal.

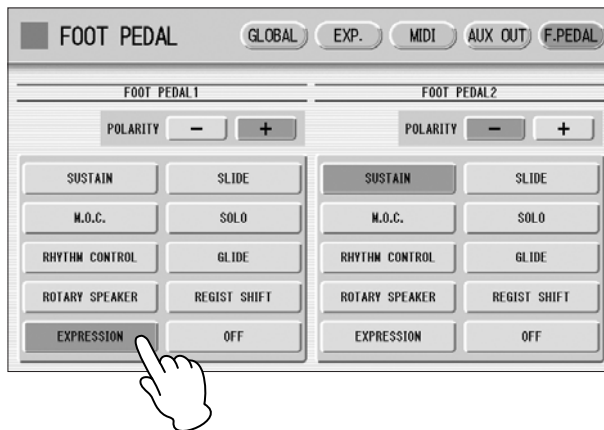

2 Press the Foot Pedal down to control the Expression.

3 Expression Pedals

The Pedal Unit DDKU-P7 features a expression pedal and a 2nd expression pedal. The Expression pedal can be used to control the volume with your foot as you play. The 2nd Expression Pedal can be used to control the Pitch Bend and the Tempo of the Rhythm. The explanation on the 2nd Expression Pedal is given here.



Reference Page

Connecting a Pedal Unit (page 229)



Reference Page

Getting Started (page 11)

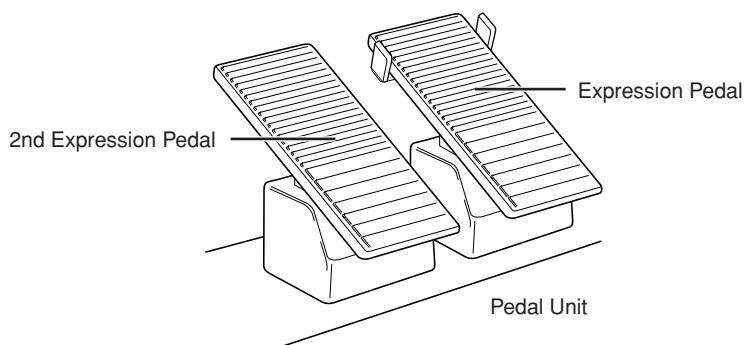

1 Press the [UTILITY] button on the front panel.

The Utility display appears.

2 Press the [EXP.] button in the upper right of the display to call up the EXP. (Expression) Page.

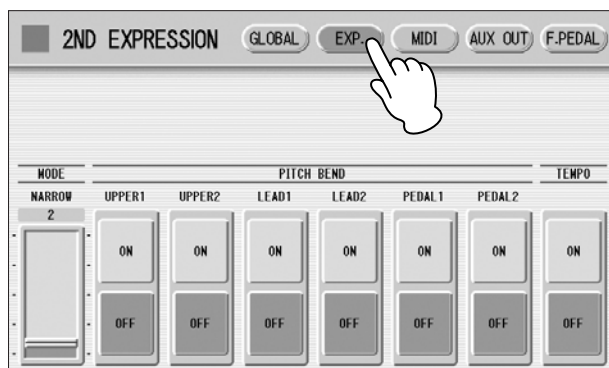

In this display, you can assign the Pitch Bend control or Tempo control to the 2nd Expression Pedal. If both Pitch Bend and Rhythm Tempo controls are set to ON, both functions are applied when you press the 2nd Expression Pedal. Generally one of them is assigned to the 2nd Expression Pedal.

Controlling Pitch Bend

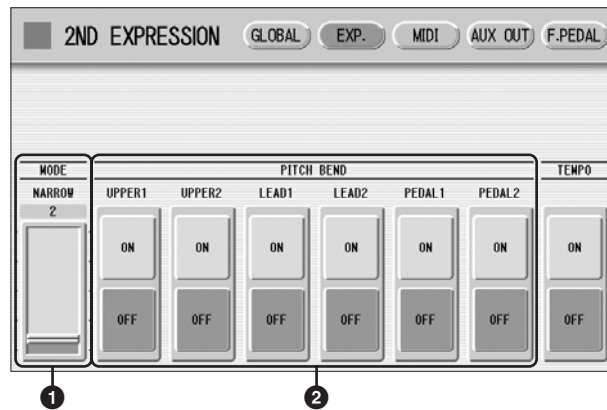

① MODE

Determines the range of the Pitch Bend control. Each step changes the pitch range by a semitone.

Range: 1 – 12

The setting 2 (NARROW) results in a small amount of pitch variation (over +/- two semitones); the setting 12 (WIDE) results in a large amount of pitch variation (over +/- one octave).

② Voice Sections (PITCH BEND)

Selects the Voice sections to which the Pitch Bend function will be applied, and turns the function ON. Pitch Bend can be selected independently or together for Upper Voices 1 and 2, Lead Voice 1 and 2, Pedal Voices 1 and 2.

Controlling the Rhythm Tempo

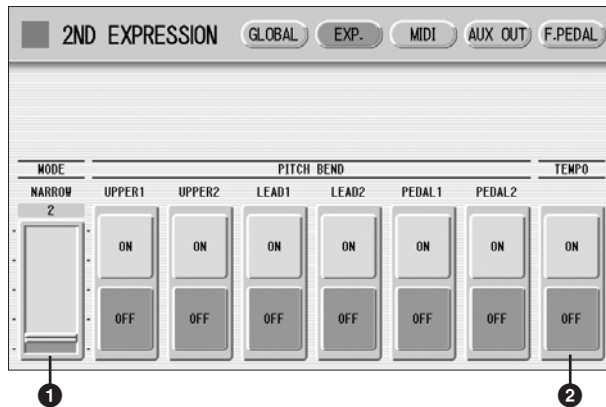

1 MODE

Determines the range of tempo change.

Range: 1 – 12

The setting 2 (NARROW) results in a small amount of tempo change (70% – 140%); the setting 12 (WIDE) results in a large amount of tempo change (50% – 200%).

2 TEMPO

When you want to control the tempo with the 2nd Expression Pedal, set this to “ON.” When set to on, pressing the pedal down with your toe speeds up the tempo and pressing it back with your heel slows it down.

11 Transpose and Pitch Controls

There are two pitch-related controls on the DDK-7: Transpose and Pitch. Transpose allows you to change the key of the instrument and Pitch lets you finely adjust the tuning. Transpose and Pitch can be adjusted in the Utility display. (The settings here cannot be recorded to the Music Data Recorder.)

- 1 Press the [UTILITY] button.
The Utility display appears.

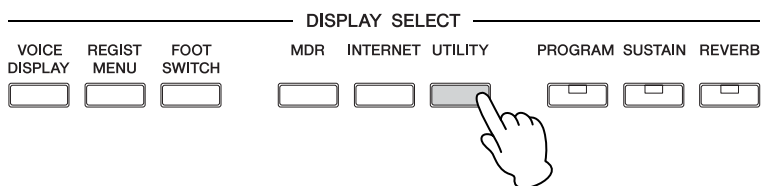

- 2 Press the [GLOBAL] button at the top right of the display to call up the GLOBAL Page.

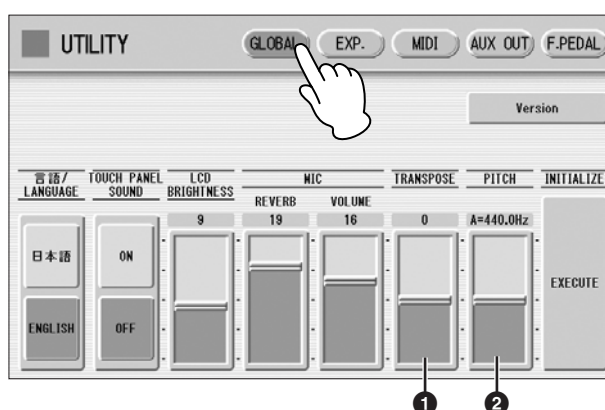

In this display, you can change the Transpose and Pitch settings.



NOTE

The Transpose setting here is not applied to an XG Song (page 126).

1 TRANSPOSE

Determines the coarse pitch setting of all the Voices, and is adjustable in half-steps (semitones).

Range: -6 – +6

2 PITCH

Determines the fine pitch setting of all the Voices. Each step changes the pitch by 0.2 Hz. The default Pitch is 440.0 Hz (corresponding to key A3).

Range: 427.2 Hz – 452.6 Hz

You can also change the Transpose and Pitch for each Voice section, in the Voice Condition display. For more information, see page 43.

12 Internet Direct Connection

This convenient, powerful feature lets you directly connect your DDK-7 to the Internet. In this section, you may come across some unfamiliar terms and phrases related to computers and online communications. To look up the meaning of these terms, refer to the Internet Glossary (page 222).

Contents	
1 Connecting the Instrument to the Internet209	3 About the Internet Settings Display218
2 Accessing the Website from the DDK-7210	• Browser218
• Scrolling the Display211	• LAN219
• Following Links211	• Wireless LAN219
• Refreshing a Web Page/Canceling Loading of a Web Page213	• Others220
• Return to the Previous Web Page213	4 Exiting from the Internet Display221
• Saving Bookmarks of Your Favorite Pages214	5 Initializing Internet Settings221
• Editing Bookmarks216	6 Glossary of Internet Terms222
• Changing the Home Page217	

1 Connecting the Instrument to the Internet

You can connect the instrument to a full-time online connection (ADSL, optical fiber, cable Internet, etc.) via a router or a modem equipped with a router.

Use a computer to connect to the Internet and get online before connecting the instrument, since no modem or router settings can be made from the instrument itself.



Depending on the Internet connection, you may not be able to connect to two or more devices (for example, a computer and the instrument), depending on the contract with the provider. This means you cannot connect with the DDK-7. If in doubt, check your contract or contact your provider.

To use the Internet connection, you will first need to subscribe to an Internet service or provider.



Connecting USB storage devices or USB-LAN adaptor (page 234)

Connection example 1: Connecting by cable (using a modem without router)

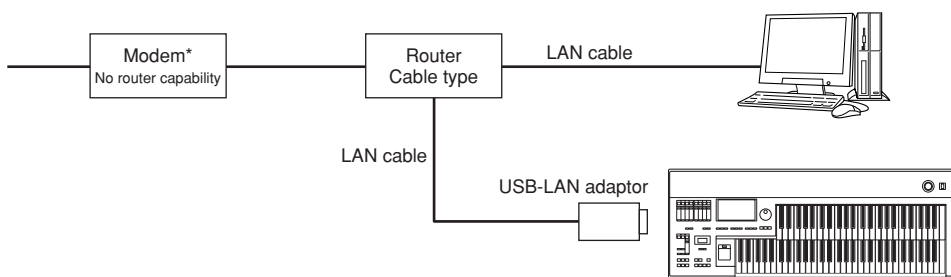

* Here, "modem" refers to an ADSL modem, optical network unit (ONU) or cable modem.



NOTE

Some types of modems require an optional hub network for simultaneously connecting to several devices (such as computer, musical instrument, etc.).

**Connection example 2:
Connecting by cable (using a modem with router)**

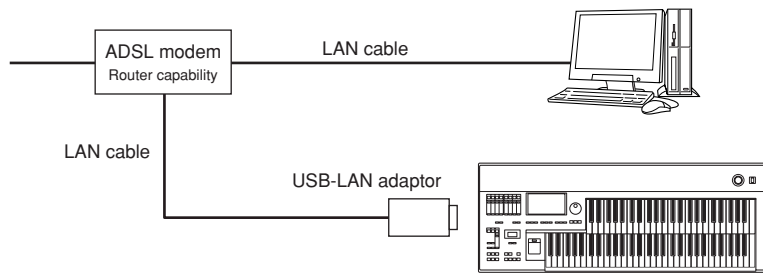

**Connection example 3:
Wireless connection**

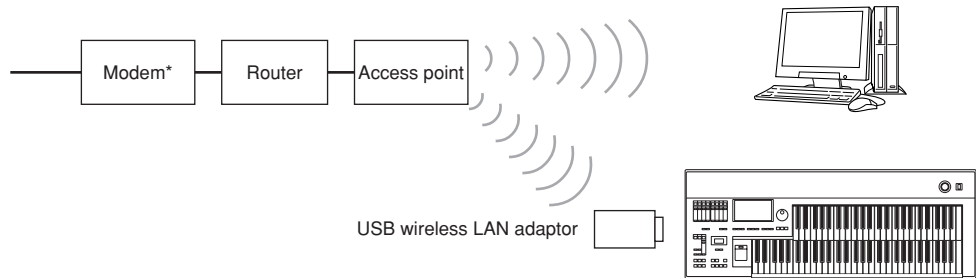

* Here, "modem" refers to an ADSL modem, optical network unit (ONU) or cable modem.

2 Accessing the Website from the DDK-7

To access the website, press the [INTERNET] button while the instrument is connected to the Internet.

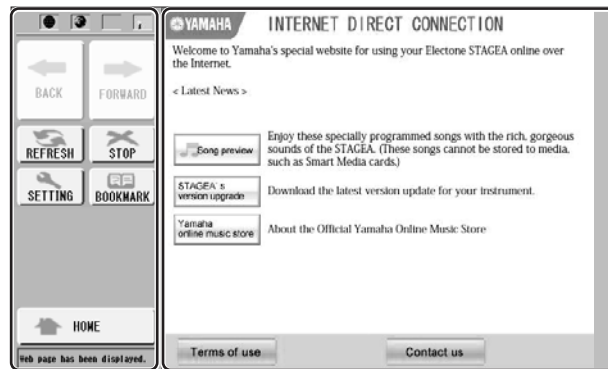
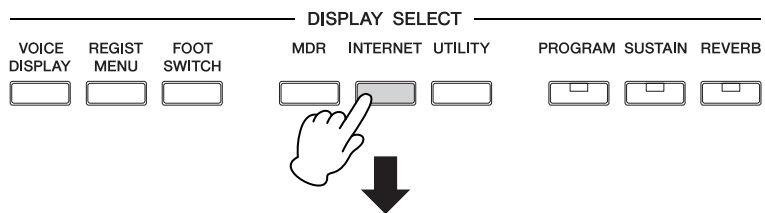

Control Menu

Browser

In the Control Menu located in the left part of the display, you can control the displayed website and set various settings. The browser display, to the right of the control menu, is the area in which the website is displayed.

The first page shown when opening a browser and connecting to the Internet is called the “home page.” If you want to return to the home page from another website, press the [HOME] button in the Control Menu.



Reference Page

Changing the Home Page
(page 217)

Scrolling the Display

When the size of the web page is too large to be shown at one time in the browser display of the instrument, a scroll bar appears at the right side or bottom of the display. Touch and move the scroll bar to view those parts of the page that are not shown.

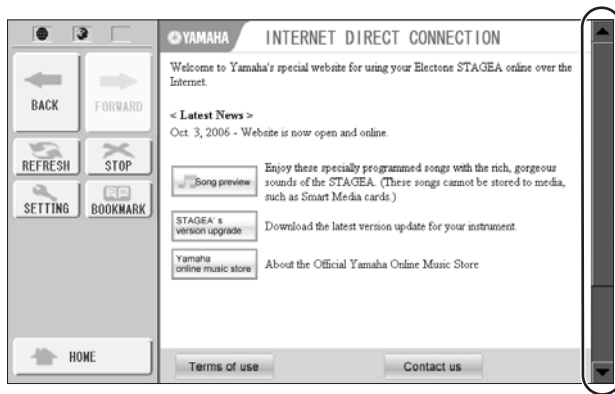

Following Links

When there is a link in the page, it is shown as a button or in colored text, etc. To select the link, press it (the button or text) directly on the display.

The touch panel will not sound when you press a link, even if the touch panel sound is set to ON in the Utility Display (page 17).

Monitoring the Internet Connection Status

The four icons and a message indicate the current Internet connection status.

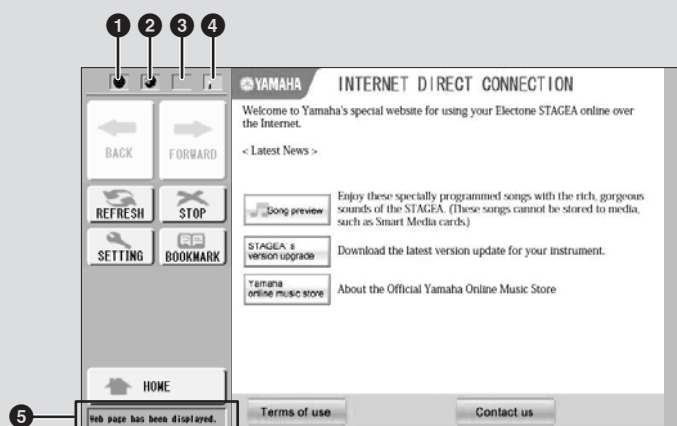

1 Offline indicator (🌐)

This is shown when the instrument is not connected to the Internet. When this appears, you cannot view any web pages.

2 Communication Status indicator (🌐)

This flashes when the web page is being loaded, indicating that communication with the site is in progress. The indicator lights continuously when loading is finished (communication is established).

3 SSL indicator (🔒)

This is shown when the opened website uses SSL, and it indicates that data is encrypted before transmission.

4 Wireless LAN indicator

When you connect the DDK-7 to Internet using wireless LAN, an icon indicating the condition of the connection is displayed. If the signal to the DDK-7 becomes weak or there is no signal from the access point, move the DDK-7 nearer to the access point.

📶: Strong

📶: Normal

📶: Weak (not connected to Internet)

📶: No signal (not connected to Internet)

5 Communication status indicator

The following three messages will be shown depending on the status of accessing web site.

Now opening web page ...	Indicates loading of the web page.
Web page has been displayed.	Indicates the web page has been loaded and the web page is completely displayed.
Disconnected.	Indicates the DDK-7 is offline (not connected to Internet).

Refreshing a Web Page/Canceling Loading of a Web Page



To refresh a web page (to make sure you have the latest version of the page, or to try reloading), press the [REFRESH] button.



To cancel loading of a page (if the page is taking too long to open), press the [STOP] button.

Return to the Previous Web Page



To return to a previously selected web page, press the [BACK] button.



To return to the page selected before pressing the [BACK] button, press the [FORWARD] button.

Saving Bookmarks of Your Favorite Pages

You can “bookmark” the page you’re viewing, and set up a custom link so the page can be instantly called up in the future.

1 With the desired page currently selected, press the [BOOKMARK] button in the control menu.

The Bookmark display appears, showing a list of the currently saved bookmarks. The title of the web page registered to the selected bookmark is shown below the list.



2 Call up the display for registering bookmarks by pressing the [ADD] button.

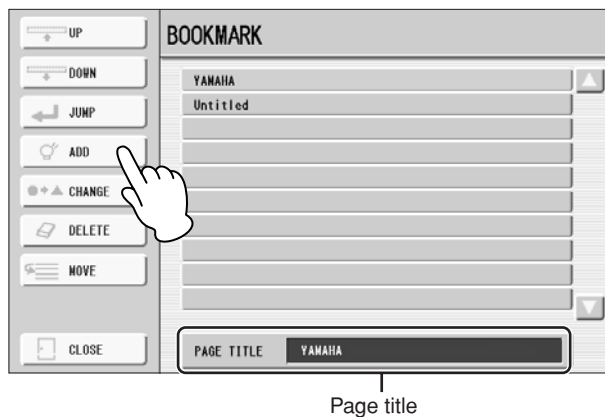

- 3 Select the position of the new bookmark by pressing the desired position directly, or using the [UP]/[DOWN] button or the Data Control Dial.

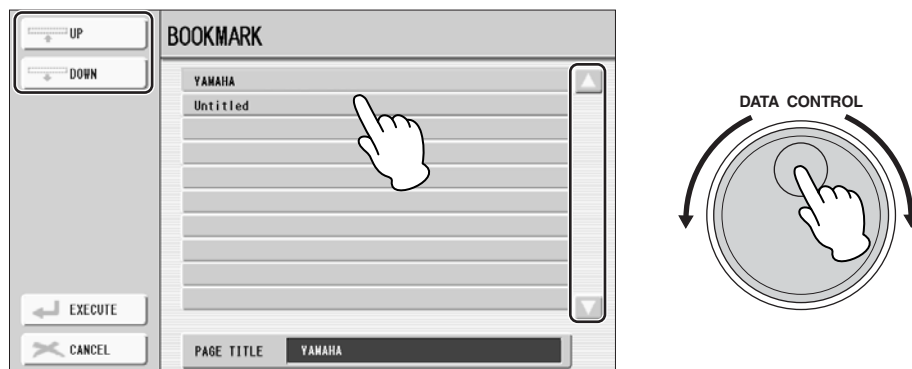

- 4 To save the bookmark, press the [EXECUTE] button, or press the [CANCEL] button to cancel.
- 5 To return to the browser, press the [EXIT] button.

Opening a Bookmarked Page:

- 1 Press the [BOOKMARK] button in the control menu to call up the Bookmark display, then select the desired bookmark.
- 2 Press the [JUMP] button to open the page of the selected bookmark.

Editing Bookmarks

From the Bookmark display, you can change the names and rearrange the order of your bookmarks, as well as delete unnecessary bookmarks from the list.



1 UP/DOWN

Moves the selection position in the Bookmark list.

2 JUMP

Opens the web page of the selected bookmark.

3 ADD

Used when saving a bookmark (page 214).

4 CHANGE

Changes the name of the selected bookmark. Pressing this button calls up the display for entering characters. For details on entering characters, see page 113.

5 DELETE

Deletes the selected bookmark from the Bookmark list.

6 MOVE

Changes the order of the bookmarks.

1 Select the bookmark you wish to move, then press the [MOVE] button.

The left part of the display changes, letting you select the new position for the bookmark.

2 Select the intended position by pressing the desired position in the display, or by using the [UP]/[DOWN] buttons or Data Control dial.

3 Move the bookmark to the selected position by pressing the [EXECUTE] button.

7 CLOSE

This closes the Bookmark display and returns to the browser display.

Changing the Home Page

You can specify any desired page on the site to be the home page. In advance, open the page you wish to set as your new home page.

1 Press the [SETTING] button in the control menu to call up the Internet Setting display.

2 Press the [Browser] button to call up the Browser Page.

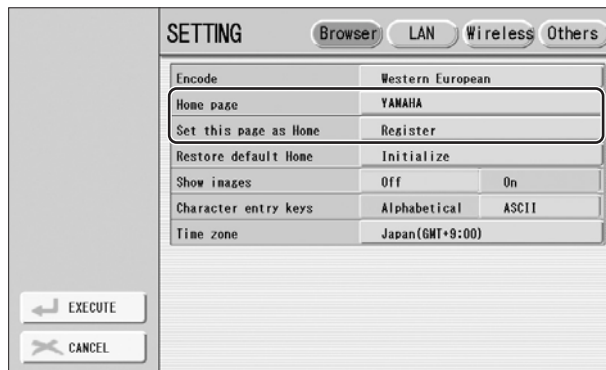

3 Press the [Register] button of the “Set this page as Home.”

4 To return to the browser, press the [EXECUTE] button in the control menu.

A message appears, prompting confirmation of the operation. Select [YES] to return to the browser.

3 About the Internet Settings Display

From the Internet Settings display, you can make various settings related to the Internet connection, including preferences for the menus and displays. The Internet Settings display has four sub-displays: Browser, LAN, Wireless LAN, and Others.

Browser

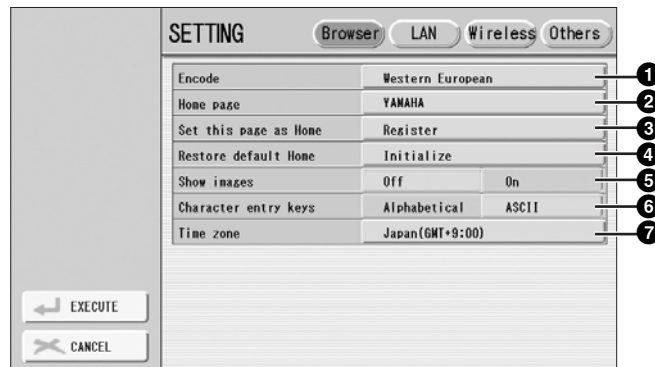

1 Encode

Selects the character code encoding for the browser.

2 Home page

Shows and allows editing of the web page which is set as the home page.

3 Set this page as Home

For details, refer to “Changing the Home Page” on page 217.

4 Restore default Home

Restores the home page setting.

5 Show images

Image data and pictures in the web page are shown in the browser when this is set to on. Image data is not shown when this is set to off.

6 Character entry keys

This setting lets you select the character order of the virtual keyboard for entering characters. When this is set to “Alphabetical,” the keys are in alphabetical order. When this is set to “ASCII,” the keys are arranged as a conventional “QWERTY” keyboard.

7 Time zone

This determines the time setting for the browser.

LAN

In this display page, you can make settings for the LAN connection. These settings are needed for not only wired LAN connection but also wireless LAN connection.

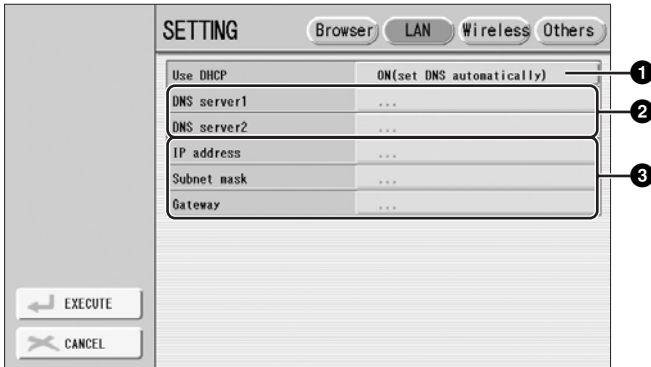

Make a written note of these settings, in case you have to enter the settings again.

Use DHCP	
DNS server 1	
DNS server 2	
IP address	
Subnet mask	
Gateway	

1 Use DHCP

Determines whether or not DHCP is used. If your router is compatible with DHCP, select “ON (set DNS automatically)” here.

2 DNS server 1 / DNS server 2

These determine the addresses of the primary and secondary DNS servers. These settings must be made when “Use DHCP” above is set to “ON (set DNS manually)” or “OFF.”

3 IP address / Subnet mask / Gateway

These settings are available only when DHCP is not used. The settings here are: IP address, subnet mask, and gateway server address. These settings must be made when “Use DHCP” above is set to “OFF.”

Wireless LAN

In this display page, you can make settings for the wireless LAN connection. These settings must be the same as the settings on the Access Point.

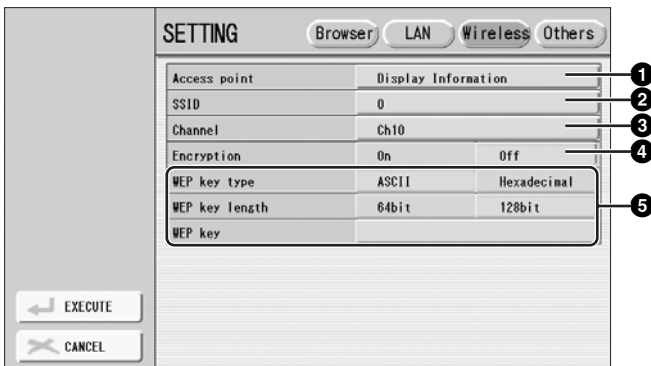

Make a written note of these settings, in case you have to enter the settings again.

SSID		
Channel	Ch	
Encryption	On	Off
WEP key type	ASCII	Hexadecimal
WEP key length	64 bit	128 bit
WEP key		

**NOTE**

An access point that is encrypted in a non-WEP format cannot be used.

**NOTE**

If no signal from the access point is received, the access point cannot be listed.

**NOTE**

The WEP key type, length and WEP key are not entered automatically. You have to enter them by yourself if you want to use an access point that is encrypted.

① Access Point

Pressing the [Display Information] button calls up the access point list. It shows the access points near the DDK-7.

Once you select the desired access point and press the [OK] button, a message appears prompting confirmation of whether to transfer the access point settings to the DDK-7 or not. When you select [YES], the SSID, Channel and Encryption settings are transferred to the DDK-7.

② SSID

Determines the SSID setting.

③ Channel

Determines the channel.

④ Encryption

Determines whether or not the data is encrypted.

⑤ WEP key type / WEP key length / WEP key

These settings are available only when Encryption above is enabled. These set the type and length of the encryption key.

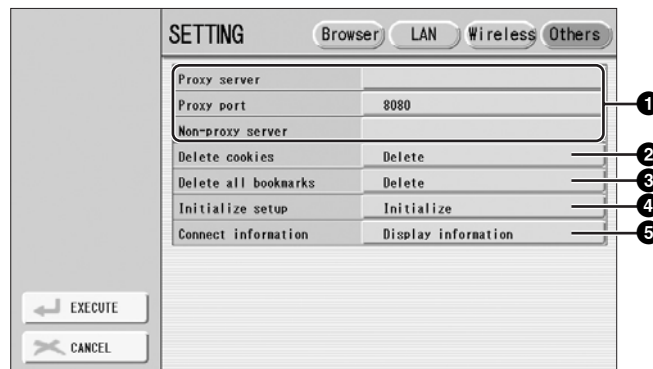
Others**NOTE**

When using two or more non-proxy servers, separate each server name with a comma.

① Proxy server / Proxy port / Non-proxy server

Determines the proxy server name, port number and the host name for a main, non-proxy server. The settings here are only necessary when using a proxy server.

② Delete cookies

Deletes the contents of all saved cookies.

③ Delete all bookmarks

Deletes all saved bookmarks.

④ Initialize setup

Restores all settings in the Internet Settings displays to their defaults. See "Initializing Internet Settings" on page 221.

5 Connection information

Shows detailed information on the current connection.

4 Exiting from the Internet Display

Pressing any button other than [INTERNET] button quits the Internet Direct Connection and closes the website display. Pressing the [INTERNET] button again automatically opens the previously opened website.

5 Initializing Internet Settings

The settings of the Internet function are not initialized when using the Initialize operation of the DDK-7 (page 23); Internet settings must be initialized separately, as explained here. Initializing will reset to the default values not only the settings of the browser, but also all settings you have made in the Internet Settings displays, including those related to Internet connection.

- 1 Press the [SETTING] button in the control menu to call up the Internet Settings display.
- 2 Press the [Others] button at the top right of the display.
- 3 Press the [Initialize] button to initialize the Internet settings.
A message appears, prompting confirmation of the operation.



- 4 Select [YES] to initialize the Internet settings, or select [NO] to abort the operation.

6 Glossary of Internet Terms

Broadband	An Internet connection technology/service (such as ADSL and optical fiber) that allows for high-speed, high-volume data communication.
Browser	The software used to search for, access, and view web pages. For this instrument, this refers to the display that shows the contents of the web pages.
Cookie	A system that records certain information that the user transfers when visiting a website and using the Internet. The function is similar to a preference file in a conventional computer program, in that it "remembers" certain information such as your user name and password, so you don't have to re-enter the information each time you visit the site.
DHCP	This is a standard or protocol by which IP addresses and other low-level network configuration information can be dynamically and automatically assigned each time connection is made to the Internet.
DNS	A system that translates names of computers connected to a network to their corresponding IP addresses.
Download	Transferring data over a network, from a larger "host" system to a smaller "client" system's hard drive or other local storage device — much like copying files from your hard disk drive to a floppy disk. For this instrument, this refers to the process of transferring Song and other data from a website to the instrument.
Gateway	A system which links different networks or systems, and makes possible data transfer and conversion despite differing communications standards.
Home page	The first page shown when opening a browser and connecting to the Internet. This phrase is also used to mean the "front screen" or top page of a website.
Internet	A huge network made up of networks, the Internet allows high-speed data transfer among computers, mobile phones and other devices.
IP address	A string of numbers assigned to each computer connected to a network, and indicating the device's location on the network.
LAN	Short for Local Area Network, this is a data-transfer network that connects a group of computers at a single location (such as an office or home) by means of a special cable.
Link	A highlighted word, button or icon within a web page that, when clicked, opens another web page.
Modem	A device which connects and allows data transfer between a conventional telephone line and a computer. It converts the digital signals from the computer to analog audio for sending over the phone line, and vice versa.
NTP	Short for Network Time Protocol, a standard for setting the internal system clock of the computer over a network. For this instrument, the internal clock of the computer is used to specify the valid time/date for cookies and SSL.
Provider	A communications business that offers Internet connection services. In order to connect to the Internet, it is necessary to contract to a provider.
Proxy	A proxy server is a server that all computers on a local network have to go through before accessing information on the Internet. It intercepts all or designated requests to the real server to see if it can fulfill the requests itself. If not, it forwards the request to the real server. Proxy servers are used to improve performance and speed, and to filter requests, usually for security and to prevent unauthorized access to an internal network.
Router	A device for connecting multiple computer networks. For example, a router is necessary when connecting several computers in a house or office, and allow them to all access the Internet and share data. A router is usually connected between a modem and a computer, although some modems have a built-in router.
Server	A hardware system or computer used as a central point for a network, providing access to files and services.
Site	Short for "website," this refers to the group of web pages that are opened together. For example, the collection of web pages whose addresses begin with "http://www.yamaha.co.jp/" is referred to as the Yamaha site.
SSID	This is an identification name for specifying a particular network over a wireless LAN connection. Communication is possible only between terminals with matching SSID names.
SSL	Short for Secure Sockets Layer, a standard for transmitting confidential data such as credit card numbers over the Internet.
Subnet mask	A setting used to divide a large-scale network into several smaller networks.
URL	Short for Uniform Resource Locator, a string of characters used to identify and link to specific websites and pages on the Internet. A complete URL usually starts with the characters "http://."
Web page	Refers to each individual page that makes up a website.
Wireless LAN	A LAN connection that allows data transfer through a wireless, cable-free connection.

13 Connections

On the backside and front left side of the DDK-7 keyboard is a separate panel equipped with various input/output terminals and miscellaneous controls.

Contents

1 Accessory Jacks and Controls	223	6 Connecting External Devices	231
2 Connecting Headphones or External System	225	• Recording the Sounds of the DDK-7 to an External Recorder	231
• Using Headphones	225	• Outputting the Sound of an External Device Through the External Speakers of the DDK-7	232
• Playing the Sounds of the DDK-7 Through an External Audio System	226	• Connecting a Microphone	232
• Using a mixer for live performance	226	• Controlling External MIDI Devices from the DDK-7	233
• Selecting Outputs for Each Part	228	• Controlling the DDK-7 from an External Device	234
3 Connecting a Pedal Unit	229	• Connecting USB storage devices or USB-LAN adaptor	234
4 Connecting a Foot Pedal	229	7 MIDI	235
5 Connection with Computer	230	• What is MIDI?	235
• Using the USB terminal	230	• MIDI Messages of the DDK-7	236
• Using the MIDI IN/OUT terminals	231	• MIDI Channels	237
		8 MIDI Control	238

1 Accessory Jacks and Controls

This section provides brief explanations for each jack/control on the DDK-7. For details on connecting to external devices, see page 225.

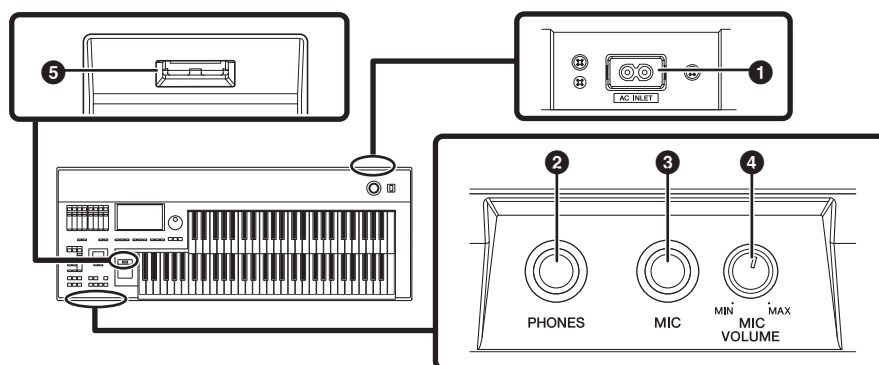

1 AC INLET jack

For connecting the power cable.

2 PHONES jacks

For connection of a stereo headphone set.

3 MIC jack

For connecting a mono input, such as a microphone. The DDK-7 outputs the microphone signal, with reverb processing, through the OUTPUT jacks or AUX OUT jacks.

4 MIC VOLUME knob

For adjusting the level of input signal from the MIC jack.



Reference Page

Using Headphones
(page 225)



Reference Page

Connecting a Microphone
(page 232)

5 USB TO DEVICE terminal

For connecting USB storage devices such as USB flash memory.

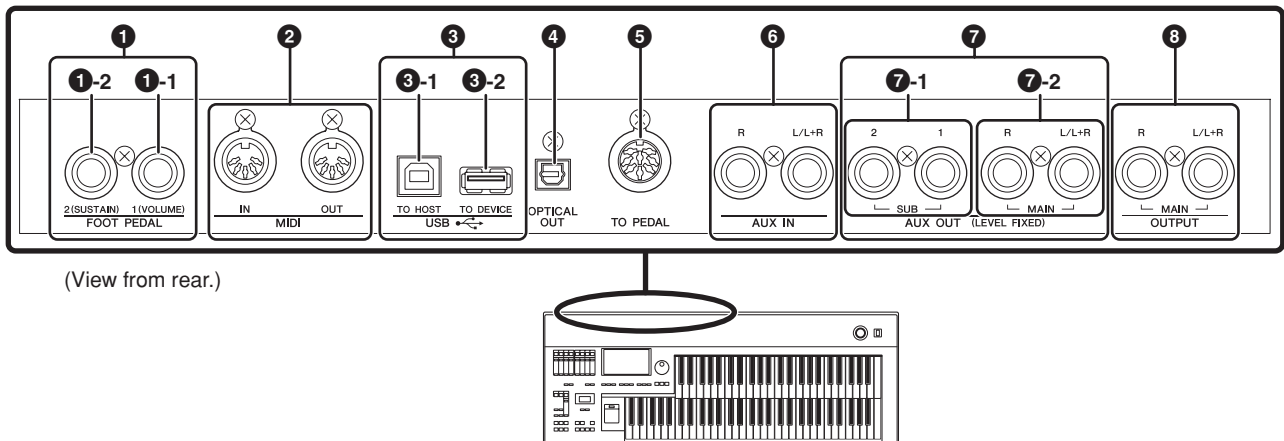

(View from rear.)



Reference Pages

Foot Pedal (page 196)



Reference Pages

Controlling External MIDI Devices from the DDK-7 (page 233)

Controlling the DDK-7 from an External Device (page 234)

Connection with Computer (page 230)

What is MIDI? (page 235)



Reference Pages

Internet Direct Connection (page 209)

Connecting USB storage devices or USB-LAN adaptor (page 234)

Connection with Computer (page 230)

1 FOOT PEDAL jacks

For connecting to an optional FC4/FC5/FC7/FC9 Foot Pedal.

1 - 1 VOLUME jack

For controlling the volume and a range of other important functions.

1 - 2 SUSTAIN jack

For controlling the sustain and a range of other important functions.

2 MIDI IN/OUT terminals

For connecting external MIDI devices such as a synthesizer or sequencer. You can also use these to connect with a computer that has a MIDI Interface.

3 USB terminals

3 - 1 USB TO DEVICE terminal

For connecting USB storage devices (such as USB flash memory) or a USB-LAN adaptor for connecting to the Internet.

3 - 2 USB TO HOST terminal

For connecting to a computer with a USB cable. To connect to a computer, make sure that an appropriate USB-MIDI driver is installed to the computer.

USB

USB is an abbreviation for Universal Serial Bus. It is a serial interface for connecting a computer with peripheral devices.

4 OPTICAL OUT terminal

For connection using an optical-fiber cable. This terminal outputs a digital signal of 44.1 kHz, 24 bits.



Reference Page

Recording the Sounds of the DDK-7 to an External Recorder (page 231)

5 TO PEDAL terminal

For connecting to the DDKU-P7 Pedal Unit.

6 AUX IN (Phone; L/L+R, R) jacks

This pair of stereo phone jacks is for connection to an external device. The signal from the connected external device sounds from external speakers connected to the DDK-7.

7 AUX OUT (LEVEL FIXED) jacks

7 - 1 SUB (1, 2) jacks

For connection to an external amplifier/speaker system. These outputs can be selected for each part.

The output level is fixed and cannot be controlled with the MASTER VOLUME Dial.

7 - 2 MAIN (L/L+R, R) jacks

This set of stereo outputs is for connection to an external amplifier/speaker. The output level is fixed and cannot be controlled.

8 OUTPUT (L/L+R, R) jacks

This set of stereo outputs is for connection to an external amplifier/speaker. The output level can be controlled.



Reference Pages

Connecting a Pedal Unit
(page 229)



Reference Page

Outputting the Sound of an
External Device Through the
External Speakers of the
DDK-7 (page 232)



Reference Pages

Playing the Sounds of the
DDK-7 Through an External
Audio System (page 226)

Recording the Sounds of the
DDK-7 to an External
Recorder (page 231)

2

Connecting Headphones or External System



Before connecting the DDK-7 to other electronic components, turn off the power to all the components. Before turning the power of the components on or off, set all volume levels to minimum (0). Otherwise, electrical shock or damage to the components may occur.

Using Headphones

To use headphones, connect to the PHONES jack.

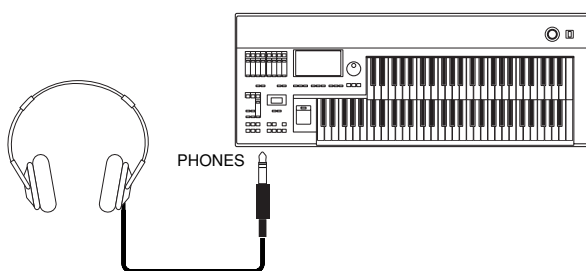

Playing the Sounds of the DDK-7 Through an External Audio System

By using the OUTPUT jacks, you can connect your DDK-7 to external powered speakers. If you're connecting the DDK-7 to a mono device, use only the OUTPUT L/L+R jack.

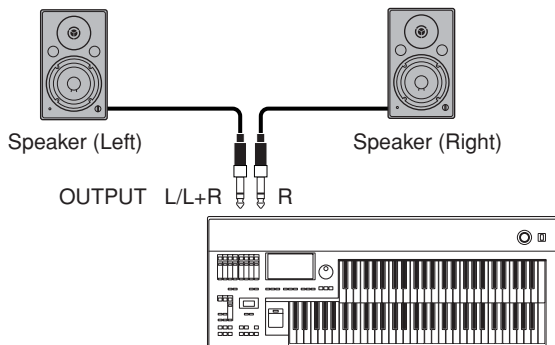

Using a mixer for live performance

Generally, when you use the DDK-7 on stage (in concert, etc.), you should connect it to a mixer. By using a mixer, you can easily adjust the volume and tone quality of each component.

To connect to a mixer, use the AUX OUT jacks of the DDK-7. The DDK-7 features two types of AUX OUT jacks: MAIN and SUB, allowing you to assign some parts of the DDK-7's output to the SUB jacks and the other parts to the MAIN jacks. In this way, you can apply effects to the specific parts or adjust the volume balance among the parts with an external mixer. For details, see "Selecting Outputs for Each Part" on page 228.

Connection example

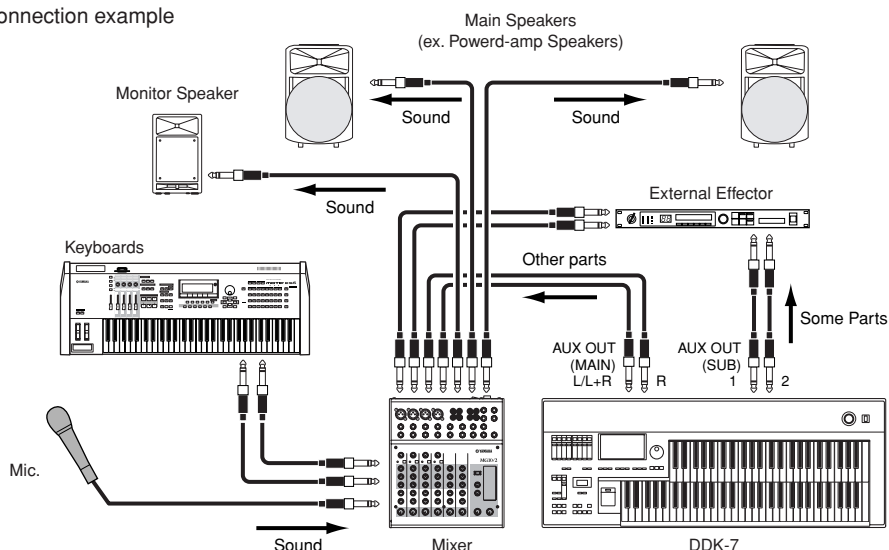

Jacks	Output Type	Location
AUX OUT MAIN jacks L/L+R, R	Unbalanced* LEVEL FIXED	Backside of the keyboard
AUX OUT SUB jacks 1, 2	Unbalanced LEVEL FIXED	Backside of the keyboard
OUTPUT jacks L/L+R, R	Unbalanced LEVEL FIXED	Backside of the keyboard

*The Unbalanced line is intended for line-level signals.

Power-on Procedure

Before turning the power on to all components, set all volume levels to minimum (0) then turn on the power in the following order:

- (1) DDK-7 and external keyboard(s)**
- (2) Mixer**
- (3) Powered Speaker**

To turn the power off, first turn down the volume for each devices, then turn off the power in the reverse order (3 → 2 → 1).

Selecting Outputs for Each Part

You can assign each individual part of the DDK-7's sounds such as Voice, Percussion, to be output from specific AUX OUT jacks: MAIN and/or SUB.

- 1 Press the [UTILITY] button to call up the GLOBAL Page of the Utility display.
- 2 Press the [AUX OUT] button in the upper right of the display to call up the AUX OUT Page.

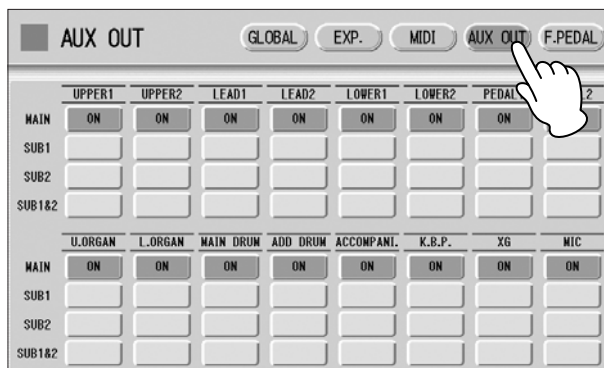

You can assign individual parts to the AUX OUT MAIN and/or SUB jacks: each Voice section, Organ Flute Voice, Main drum, Add drum, Accompaniment, Keyboard Percussion, XG and microphone to the AUX OUT MAIN and/or SUB jacks.

- 3 Turn the desired output on for each part.
You can select these from MAIN, SUB1, SUB2 and SUB1&2.

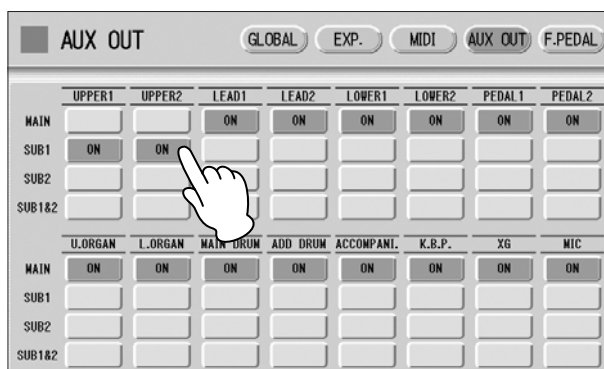

NOTE

Chorus and variation effects of the Rhythm, and Reverb are not applied to the sound output through SUB1, SUB2 and SUB1&2.



NOTE

The settings in the Utility display are automatically saved when another display is called up.

If you select a setting other than MAIN, no sound will be heard from the headphones and monitor speakers because the parts assigned to SUB1, SUB2 and SUB1&2 will not be output through the PHONES and OUTPUT jacks. Any parts assigned to the AUX OUT MAIN or SUB1&2 will be output in stereo (1: left, 2: right). Any parts assigned to AUX OUT SUB1 or SUB2 will be output in mono.

3 Connecting a Pedal Unit

Connecting a Pedal Unit (DDKU-P7) to the DDK-7 allows you to use the Pedalboard, right and left Footswitches, Expression Pedal and 2nd Expression Pedal. These foot-operated controls allow you to execute various performance functions and switch effects on/off, without taking your hands from the keyboard. If you connect and disconnect the Pedal Unit, you must be sure to first turn off the power of the DDK-7, then use the cable to make the connection. If you connect and disconnect the cable while the power to the DDK-7 is on, DDK-7 and the Pedal Unit can be damaged.

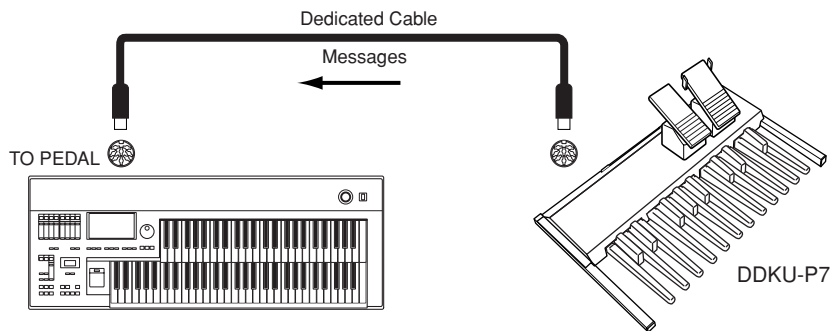

Reference Page

Voices for each keyboard (page 24)
Footswitches (page 193)
Expression Pedals (page 205)

4 Connecting a Foot Pedal

Connecting an optional Foot Pedal (FC4/FC5/FC7/FC9) to the DDK-7 allows you to execute various performance functions and switch effects on/off, without taking your hands from the keyboard. To do this, you must assign a desired function to the Foot Pedal.

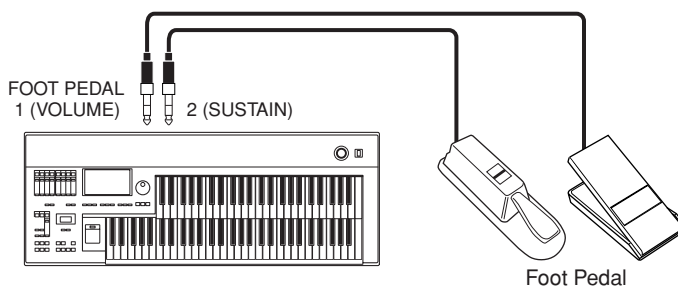

Reference Page

Foot Pedal (page 196)
Controlling Sustain (page 198)
Controlling Melody On Chord (page 200)
Controlling Lead Slide (page 199)
Controlling the Solo Function (page 201)
Controlling the Rhythm (page 201)
Controlling Rotary Speaker (page 196)
Controlling Expression (page 204)
Controlling Registration Shift (page 203)
Controlling Glide (page 202)

5 Connection with Computer

By using the USB TO HOST terminal or MIDI IN/OUT terminals, you can connect your DDK-7 to a computer and receive/transmit MIDI data (for more information about MIDI, see page 235).



Before you can actually transfer data between the DDK-7 and a computer via the USB connection, you will need to install an appropriate MIDI driver. Download the latest MIDI driver software from the Yamaha web site at “<http://music.yamaha.com/download/>.”



NOTE

When you are using the M.D.R., MIDI data cannot be transferred to/from the computer.

Connecting your DDK-7 to a computer opens up a whole new world of musical possibilities. You can save your original songs to computer and create notation (score writing application or sequencing software is needed), and even upload your original DDK-7 song data to your own website, to promote your talents or share songs with your friends. You can also control the DDK-7 from the computer, for example, by playing a MIDI file on the computer to play back the sounds of your DDK-7.

Using the USB terminal

Using the DDK-7's USB TO HOST terminal and a standard USB cable, connect the DDK-7 and the computer.

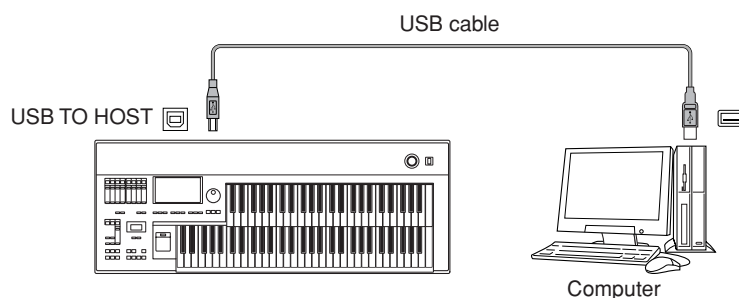

MIDI terminals are automatically disabled when the USB TO HOST terminal is used.

Precautions when using the USB TO HOST terminals

When connecting the computer to the USB TO HOST terminal, make sure to observe the following points. Failing to do so may result in freezing of the computer, corrupting data, and even losing data.

If the computer or the instrument freezes, turn the power to the instrument off or restart the computer.



- Before connecting the computer to the USB TO HOST terminal, exit from any power-saving mode (such as suspended, sleep, standby) of the computer.
- Before turning on the power to the instrument, connect the computer to the USB TO HOST terminal.
- Execute the following before turning the power to the instrument on/off or plugging/unplugging the USB cable to/from the USB TO HOST terminal.
 - Quit any open applications.
 - Make sure that data is not being transmitted from the instrument. (Data is transmitted only by playing notes on the keyboard or playing back a Song.)
- While a USB device is connected to the instrument, you should wait for six seconds or more between these operations: When turning the power of the instrument off then on again, or when alternately connecting/disconnecting the USB cable.

Using the MIDI IN/OUT terminals

By using an optional MIDI interface such as the UX16, you can connect the DDK-7 to the computer, with the MIDI IN/OUT terminals on the instrument. Connect the DDK-7 and the MIDI Interface with two standard MIDI cables (one connecting the OUT terminal on the DDK-7 to the MIDI IN terminal on the interface, and the other connecting the IN terminal on the DDK-7 to the MIDI OUT terminal on the interface). Connect the MIDI interface to the computer with a USB cable.



NOTE

Depending on your particular MIDI interface, you may have to connect the MIDI Interface and the computer with a serial cable.

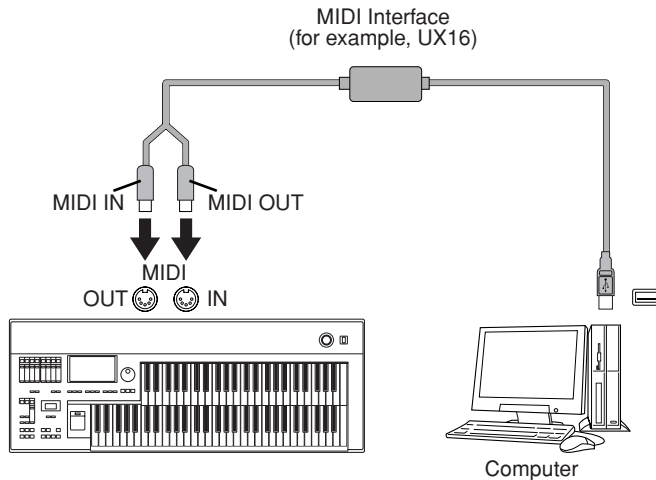

6 Connecting External Devices

Recording the Sounds of the DDK-7 to an External Recorder

You can record your DDK-7 performance to an external recorder, such as an MD recorder or cassette tape recorder, using the OPTICAL OUT terminal or AUX OUT jacks. Using the OPTICAL OUT terminal allows you to record to external media with exceptionally high-quality digital sound (providing the external recorder has an Optical In terminal). Or you can use the AUX OUT jacks.



NOTE

If you want to record the sound input from the AUX IN jack together with the DDK-7 sound, use the AUX OUT MAIN jack.

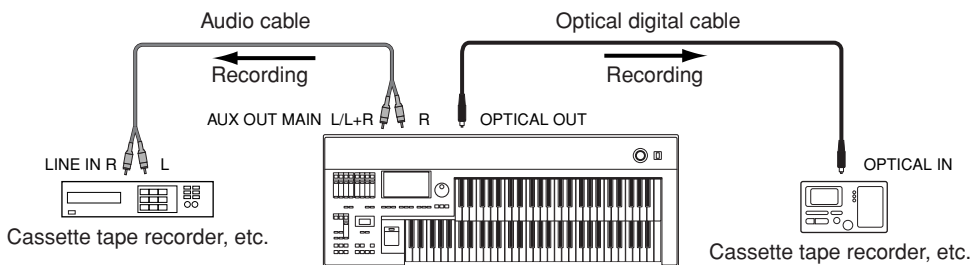

Outputting the Sound of an External Device Through the External Speakers of the DDK-7

You can connect the AUX IN jacks of the DDK-7 with the LINE OUT of an external device, such as a CD player. You can also connect the OUTPUT jacks of the DDK-7 to external speakers. The sound from the CD player is output from an external audio system via the DDK-7.

First turn on the power of the external device(s), then that of the DDK-7. Reverse this order when you turn the power off.

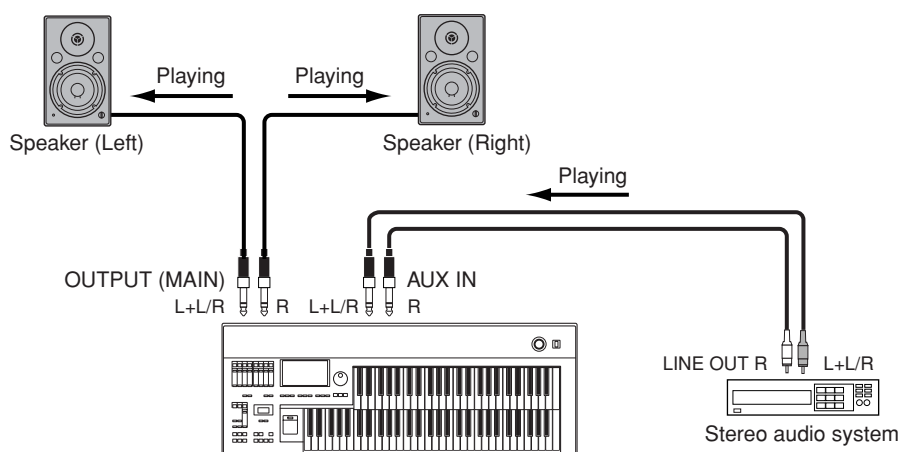

If you're connecting the DDK-7 to a mono device, use only the AUX IN L/L+R jack.

Connecting a Microphone

By connecting a microphone to the DDK-7, you can enjoy singing along with your own performance. The DDK-7 outputs your vocals through the external audio system connected to the AUX OUT or OUTPUT jacks of the DDK-7.

- 1 Connect your microphone to the MIC jack.**
A dynamic microphone is recommended.

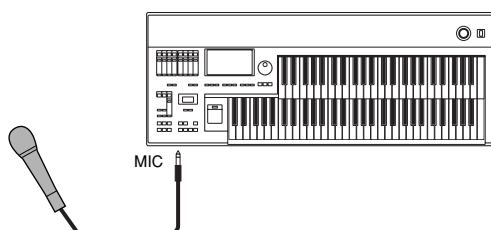

- 2 Use the MIC VOLUME knob to set the microphone volume.**



To adjust the volume/reverb:

- 1 Press the [UTILITY] button on the panel to call up the Utility display.
- 2 Using the MIC. REVERB and VOLUME sliders in the GLOBAL Page, adjust the amount of the reverb applied to the microphone, and the volume.



Reference Page

Reverb (page 48)

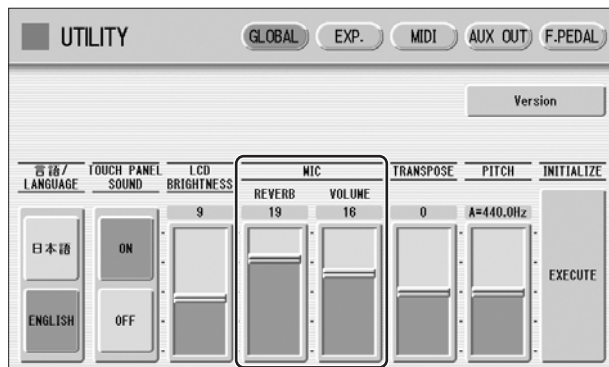

No sound from the microphone can be heard even though you raise the volume here, unless you turn the MIC VOLUME knob to the right. Similarly, no reverb can be heard even though you raise the reverb level here, unless you raise the total reverb level in the REVERB display.

Controlling External MIDI Devices from the DDK-7

You can use the DDK-7 to remotely play the Voices of a MIDI keyboard (or tone generator), combining them with the DDK-7 and letting you create even richer, more multi-layered sound textures. (The MIDI receive channels of the MIDI keyboard must match the transmit channels on your DDK-7.)

The DDK-7 transmits as digital data a variety of performance messages along with note information, including values that indicate how far the expression pedal is pressed down and how hard you play the keyboard. How the connected external device responds to these messages depends on the particular device.



Reference Page

What is MIDI? (page 235)

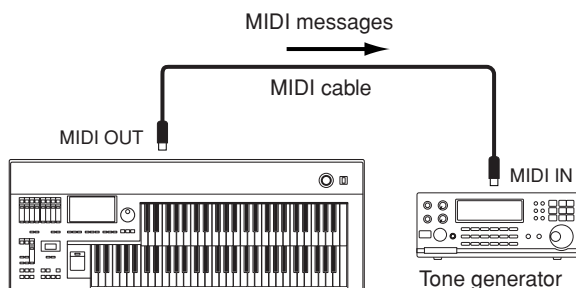

NOTE

When you are using the M.D.R., MIDI data cannot be transmitted.

MIDI terminals are automatically disabled when the USB TO HOST terminal is used.

Controlling the DDK-7 from an External Device



NOTE

When you are using the M.D.R., MIDI data cannot be received.

You can use an external MIDI keyboard or sequencer to remotely play the sounds of your DDK-7 and change its Registrations. (You will need to set the MIDI transmit channels of the MIDI keyboard to match the fixed receive channels on your DDK-7.)

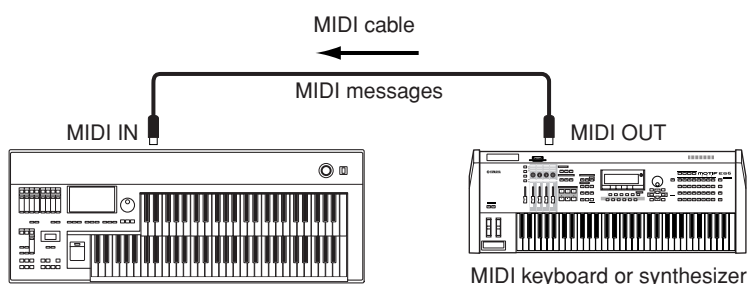

MIDI terminals are automatically disabled when the USB TO HOST terminal is used.

Connecting USB storage devices or USB-LAN adaptor



Reference Pages

Internet Direct Connection
(page 209)

Formatting External Media
(page 103)

Using the USB TO DEVICE terminal(s), you can connect USB storage devices for saving your DDK-7 data, and/or a USB-LAN adaptor for direct connection to the Internet.

Compatible USB devices

You can connect a single USB-LAN adaptor and up to two USB storage devices (such as USB flash memory) to the USB TO DEVICE terminal(s). Before purchasing a USB-LAN adaptor or USB storage devices, please consult your Yamaha dealer, or an authorized Yamaha distributor for advice, or see the Yamaha website (<http://www.global.yamaha.com/>).



NOTE

If necessary, use a USB hub. Only self-powered (battery or external power supply) types can be used. USB hubs of up to one levels can be used.

Precautions when using the USB TO DEVICE terminals



- Never turn the USB device's power on/off and never plug/unplug the USB cable when the connected USB storage device is of the self-powered type. Doing so may result in the operation of the DDK-7 "freezing" or hanging up.
- While the instrument is accessing data (such as Save, Load, and Delete operations), do NOT unplug the USB cable, do NOT remove the media from the device, and do NOT turn the power off to either device. Doing so may corrupt the data on either or both devices.

7 MIDI

This section explains what MIDI is, and what it can do, as well as how you can use MIDI on your DDK-7.

What is MIDI?

No doubt you have heard the terms “acoustic instrument” and “digital instrument.” In the world today, these are the two main categories of instruments. Let’s consider a grand piano and a classical guitar as representative acoustic instruments. They are easy to understand. With the piano, you strike a key, and a hammer inside hits some strings and plays a note. With the guitar, you directly pluck a string and the note sounds. But how does a digital instrument go about playing a note?

Acoustic guitar note production

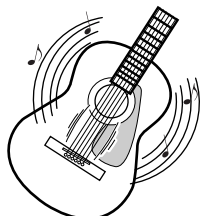

Pluck a string and the body resonates the sound.

Digital instrument note production

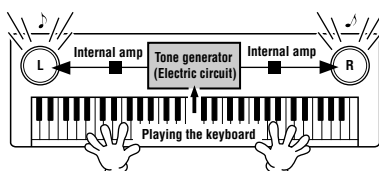

Based on playing information from the keyboard, a sampled note stored in the tone generator is played through the speakers.

As shown in the illustration above, in an electronic instrument the sampled note (previously recorded note) stored in the tone generator section (electronic circuit) is played based on information received from the keyboard, and output through the speakers. So then what is the information from the keyboard that becomes the basis for note production?

For example, let’s say you play a “C” quarter note using the grand piano sound on the keyboard. Unlike an acoustic instrument that puts out a resonated note, the electronic instrument puts out information from the keyboard such as “with what Voice,” “with which key,” “about how strong,” “when was it pressed” and “when was it released.” Then each piece of information is changed into a number value and sent to the tone generator. Using these numbers as a basis, the tone generator plays the stored sampled note.

Example of Keyboard Information

Voice number (with what Voice)	01 (grand piano)
Note number (with which key)	60 (C3)
Note on (when was it pressed)	Timing expressed numerically (quarter note)
Velocity (about how strong)	120 (strong)

As described above, your keyboard performance and panel operations such as Voice selection are handled as MIDI events. All rhythm-related data – including rhythm patterns, auto accompaniment patterns, Rhythm Sequences, etc. – also consist of MIDI messages.

MIDI (Musical Instrument Digital Interface) allows electronic musical instruments to communicate with each other, by sending and receiving compatible Note, Control Change, Program Change and various other types of MIDI data, or messages.

MIDI Messages of the DDK-7

MIDI messages can be divided into two groups: the Channel Messages and System Messages. Channel Messages consist of data related to the performance on the keyboard for a specific channel. System Messages consist of data that allows several MIDI devices to communicate with each other.

Channel Messages

Each time you play the keyboard on the DDK-7, channel messages (indicating which keys are played and how strongly) are transmitted via a specific channel. Similarly, the DDK-7 can be played remotely when receiving this data from an external keyboard.

Note On: Indicates which keys are played with the note numbers 0 through 127. The reception note range is C-2 (0) – G8 (127), C3 = 60.

Note Off: Generated when a key is released.

Velocity: Indicates how strongly the key is played. The range is 1 – 127.

For more detailed information, see MIDI Data Format on page 248 and MIDI Implementation Chart on page 261.

- **Program Change**

Program Change messages allow you to change Voices in the middle of a song. With these messages you can change the Registrations of the DDK-7. For more detailed information, see MIDI Data Format on page 248 and MIDI Implementation Chart on page 261.

- **Control Change**

Control Change Messages let you select Voice banks, control the volume, panning, modulation, portamento time, brightness and various other sound parameters, through specific Control Change numbers.

For more detailed information on the Control Change messages available on the DDK-7, see MIDI Data Format on page 248 and MIDI Implementation Chart on page 261.

System Messages

- **System Exclusive Messages**

System Exclusive messages are used to exchange the system and Voice/Registration data.

MIDI Channels

MIDI data is assigned to one of sixteen MIDI channels. Using these channels, 1 – 16, the performance data for sixteen different instrument parts can be simultaneously sent over one MIDI cable.

Think of the MIDI channels as TV channels. Each TV station transmits its broadcasts over a specific channel. Your home TV set receives many different programs simultaneously from several TV stations and you select the appropriate channel to watch the desired program.

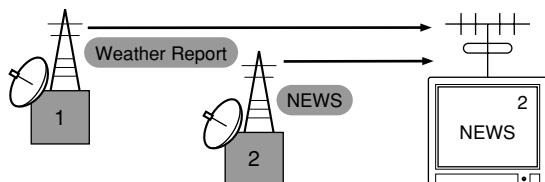

MIDI operates on the same basic principle. The transmitting instrument sends MIDI data on a specific MIDI channel (MIDI Transmit Channel) via a single MIDI cable to the receiving instrument. If the receiving instrument's MIDI channel (MIDI Receive Channel) matches the Transmit Channel, the receiving instrument will sound according to the data sent by the transmitting instrument.

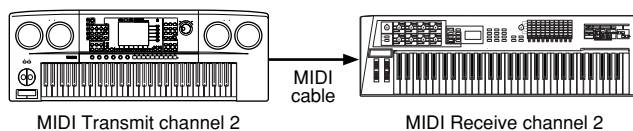

The receive channel of the DDK-7 is fixed at channel 1 for the Upper Keyboard, channel 2 for the Lower Keyboard, and channel 3 for the Pedalboard. This means that when you are using another MIDI device to play the DDK-7's Voices, you must set the MIDI transmit channel(s) of the connected device to match the receive channel(s) of the DDK-7. You can select the transmit channel for each keyboard (Upper, Lower and Pedal) from channels 1 – 16. See page 238 for more information.

8 MIDI Control

When you connect your DDK-7 with a second MIDI device (such as a synthesizer or computer), you can determine how the DDK-7 controls that MIDI device, or how the DDK-7 is controlled.

1 Press the [UTILITY] button in the panel to call up the Utility Display.

2 Press the [MIDI] button at the top right of the display to call up the MIDI Page.

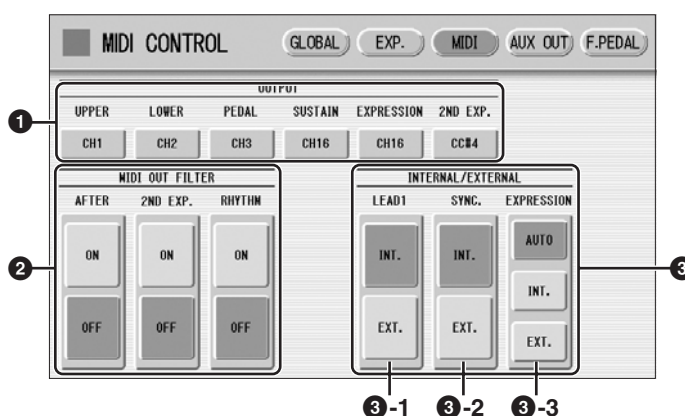

1 OUTPUT

For setting the channels over which MIDI information will be transmitted. Any channel from 1 through 16 can be assigned to the Upper keyboard, the Lower keyboard, the Pedalboard, Sustain, Expression Pedal and 2nd Expression Pedal. The MIDI messages on each keyboard will be sent on the channels set here. You must set the transmit channel here to match the receive channel of the connected device. Pressing each OUTPUT button calls up the channel selection pop-up menu. After you select the desired channel, the pop-up menu automatically closes.

Sustain, Expression Pedal and 2nd Expression Pedal can be set to “OFF” (MIDI information will not be transmitted.)

2 MIDI OUT FILTER

Deletes unnecessary MIDI data and keeps it from being transmitted from the DDK-7. After Touch, second Expression and Rhythm start/stop are automatically filtered. Set the parameter for which you wish to disable transmission to ON.

③ INTERNAL/EXTERNAL

Switches control over the displayed items between the DDK-7 (INTERNAL) or the connected device (EXTERNAL).

③ - 1 LEAD 1

Determines Internal or External control of the Lead Voices.

INT. (Internal): Lead Voice 1 is played from the Upper keyboard of the DDK-7.
(If the To Lower function is on, it is played from Lower keyboard.)

EXT. (External): The Lead Voice 1 is played from the connected instrument via MIDI channel 4.

③ - 2 SYNC.

To synchronize playback with an external MIDI device, you can use either the instrument's internal clock (int.) or MIDI clock signals from the external device (ext.).

INT. (Internal): The instrument uses its own internal clock.

EXT. (External): The instrument uses MIDI clock signals from the external device (midi).

③ - 3 EXPRESSION

Determines the control of the expression pedal functions. Ordinarily, this control is set to AUTO.

AUTO: Internal and External is automatically switched.

INT. (Internal): You can manually control the expression pedal and Foot Pedal even during M.D.R. playback.

EXT. (External): While playing the M.D.R. or receiving MIDI messages, the expression pedal and Foot Pedal is invalid. (The volume is controlled by the recorded data in a USB flash memory or received MIDI data.)

XG Voice & Drum List

Only for XG song playback.

Voice Number			Voice Name	Category
MSB	LSB	PRG		
0	0	1	XG GrandPiano	PIANO
0	1	1	XG GrndPianoKSP	
0	18	1	XG MellowGrPno	
0	40	1	XG PianoStrings	
0	41	1	XG Dream	
0	0	2	XG BrightPiano	
0	1	2	XG BritePnoKSP	
0	0	3	XG El.GrandPiano	
0	1	3	XG El.GrndPnoKSP	
0	32	3	XG DetunedCP80	
0	40	3	XG LayeredCP1	
0	41	3	XG LayeredCP2	
0	0	4	XG Honkytonk	
0	1	4	XG HonkytonkKSP	
0	0	5	XG El.Piano1	
0	1	5	XG El.Piano1KSP	
0	18	5	XG MellowEP1	
0	32	5	XG ChorusEP1	
0	40	5	XG HardEl.Piano	
0	45	5	XG VxfadeEl.P1	
0	64	5	XG 60'sEl.Piano1	
0	0	6	XG El.Piano2	
0	1	6	XG El.Piano2KSP	
0	32	6	XG ChorusEP2	
0	33	6	XG DXEPHard	
0	34	6	XG DXLegend	
0	40	6	XG DXPhaseEP	
0	41	6	XG DX+AnalogEP	
0	42	6	XG DXKotoEP	
0	45	6	XG VxfadeEl.P2	
0	0	7	XG Harpsichord	
0	1	7	XG Harpsi.KSP	
0	25	7	XG Harpsichord2	
0	35	7	XG Harpsichord3	
0	0	8	XG Clavi.	
0	1	8	XG Clavi.KSP	
0	27	8	XG Clavi.Wah	
0	64	8	XG PulseClavi.	
0	65	8	XG PierceClavi.	
0	0	9	XG Celesta	CHROMATIC PERC.
0	0	10	XG Glockenspiel	
0	0	11	XG MusicBox	
0	64	11	XG Orgel	
0	0	12	XG Vibraphone	
0	1	12	XG VibesKSP	
0	45	12	XG HardVibes	
0	0	13	XG Marimba	
0	1	13	XG MarimbaKSP	
0	64	13	XG SineMarimba	
0	97	13	XG Balimba	
0	98	13	XG LogDrums	

Voice Number			Voice Name	Category	
MSB	LSB	PRG			
0	0	14	XG Xylophone	CHROMATIC PERC.	
0	0	15	XG TubularBells		
0	96	15	XG ChurchBells		
0	97	15	XG Carillon		
0	0	16	XG Dulcimer		
0	35	16	XG Dulcimer2		
0	96	16	XG Cimbalom		
0	97	16	XG Santur		
0	0	17	XG DrawbarOrgan		ORGAN
0	32	17	XG DetDrawOrg		
0	33	17	XG 60'sDrawOrg1		
0	34	17	XG 60'sDrawOrg2		
0	35	17	XG 70'sDrawOrg1		
0	36	17	XG DrawbarOrgan2		
0	37	17	XG 60'sDrawOrg3		
0	38	17	XG EvenBarOrg		
0	40	17	XG 16+2'2_3Org		
0	64	17	XG OrganBass		
0	65	17	XG 70'sDrawOrg2		
0	66	17	XG CheezyOrgan		
0	67	17	XG DrawbarOrgan3		
0	0	18	XG Perc.Organ		
0	24	18	XG 70'sPercOrg1		
0	32	18	XG Det.Perc.Org		
0	33	18	XG LightOrgan		
0	37	18	XG Perc.Organ2		
0	0	19	XG RockOrgan		
0	64	19	XG RotaryOrgan		
0	65	19	XG SlowRotary		
0	66	19	XG FastRotary		
0	0	20	XG ChurchOrgan		
0	32	20	XG ChurchOrgan3		
0	35	20	XG ChurchOrgan2		
0	40	20	XG NotreDame		
0	64	20	XG OrganFlute		
0	65	20	XG Trem.OrganFl		
0	0	21	XG ReedOrgan		
0	40	21	XG PuffOrgan		
0	0	22	XG Accordion		
0	32	22	XG AccordIt		
0	0	23	XG Harmonica		
0	32	23	XG Harmonica2		
0	0	24	XG TangoAccord		
0	64	24	XG TangoAccord2		
0	0	25	XG NylonGuitar	GUITAR	
0	16	25	XG NylonGuitar2		
0	25	25	XG NylonGuitar3		
0	43	25	XG Vel.GtrHarmo		
0	96	25	XG Ukulele		
0	0	26	XG SteelGuitar		
0	16	26	XG SteelGuitar2		

Voice Number			Voice Name	Category	
MSB	LSB	PRG			
0	35	26	XG 12StrGuitar	GUITAR	
0	40	26	XG Nylon&Steel		
0	41	26	XG Steel&Body		
0	96	26	XG Mandolin		
0	0	27	XG JazzGuitar		
0	18	27	XG MellowGuitar		
0	32	27	XG JazzAmp		
0	0	28	XG CleanGuitar		
0	32	28	XG ChorusGuitar		
0	0	29	XG MutedGuitar		
0	40	29	XG FunkGuitar1		
0	41	29	XG MuteSteelGtr		
0	43	29	XG FunkGuitar2		
0	45	29	XG JazzMan		
0	0	30	XG Overdriven		
0	43	30	XG GuitarPinch		
0	0	31	XG Distortion		
0	40	31	XG FeedbackGtr		
0	41	31	XG FeedbackGtr2		
0	0	32	XG GtrHarmonics		
0	65	32	XG GtrFeedback		
0	66	32	XG GtrHarmonics2		
0	0	33	XG AcousticBass		BASS
0	40	33	XG JazzRhythm		
0	45	33	XG VXUprghtBass		
0	0	34	XG FingerBass		
0	18	34	XG FingerDark		
0	27	34	XG FlangeBass		
0	40	34	XG Bass&DistEG		
0	43	34	XG FingerSlap		
0	45	34	XG FingerBass2		
0	65	34	XG ModulatedBass		
0	0	35	XG PickBass		
0	28	35	XG MutePickBass		
0	0	36	XG FretlessBass		
0	32	36	XG FretlessBass2		
0	33	36	XG FretlessBass3		
0	34	36	XG FretlessBass4		
0	96	36	XG Syn.Fretless		
0	97	36	XG SmthFretless		
0	0	37	XG SlapBass1		
0	27	37	XG ResonantSlap		
0	32	37	XG PunchThumb		
0	0	38	XG SlapBass2		
0	43	38	XG Vel.SwSlap		
0	0	39	XG SynthBass1		
0	18	39	XG SynBass1Dark		
0	20	39	XG FastResoBass		
0	24	39	XG AcidBass		
0	35	39	XG Clavi.Bass		
0	40	39	XG TechnoBass		
0	64	39	XG Orbiter		
0	65	39	XG SquareBass		
0	66	39	XG RubberBass		
0	96	39	XG Hammer		
0	0	40	XG SynthBass2		
0	6	40	XG MellowSyBass		
0	12	40	XG SequencedBass		

Voice Number			Voice Name	Category	
MSB	LSB	PRG			
0	18	40	XG ClickSynBass	BASS	
0	19	40	XG SynBass2Dark		
0	32	40	XG SmoothSyBass		
0	40	40	XG ModulrSyBass		
0	41	40	XG DXBass		
0	64	40	XG XWireBass		
0	0	41	XG Violin		STRINGS
0	8	41	XG SlwAtkViolin		
0	0	42	XG Viola		
0	0	43	XG Cello		
0	0	44	XG Contrabass		
0	0	45	XG Trem.Strings		
0	8	45	XG SlwAtTremStr		
0	40	45	XG SuspenseStr		
0	0	46	XG PizzicatoStr		
0	0	47	XG Orch.Harp		
0	40	47	XG YangChin		
0	0	48	XG Timpani	ENSEMBLE	
0	0	49	XG Strings1		
0	3	49	XG StereoStrings		
0	8	49	XG SlwAtkStrings		
0	24	49	XG ArcoStrings		
0	35	49	XG 60'sStrings		
0	40	49	XG Orchestra		
0	41	49	XG Orchestra2		
0	42	49	XG TremOrchestra		
0	45	49	XG Vel.Strings		
0	0	50	XG Strings2		
0	3	50	XG S.SlowStrings		
0	8	50	XG LegatoStrings		
0	40	50	XG WarmStrings		
0	41	50	XG Kingdom		
0	64	50	XG 70'sStrings		
0	65	50	XG Strings3		
0	0	51	XG SynStrings1		
0	27	51	XG ResoStrings		
0	64	51	XG SynStrings4		
0	65	51	XG SynStrings5		
0	0	52	XG SynStrings2		
0	0	53	XG ChoirAahs		
0	3	53	XG StereoChoir		
0	16	53	XG ChoirAahs2		
0	32	53	XG MellowChoir		
0	40	53	XG ChoirStrings		
0	0	54	XG VoiceOohs		
0	0	55	XG SynthVoice		
0	40	55	XG SynthVoice2		
0	41	55	XG Choral		
0	64	55	XG AnalogVoice		
0	0	56	XG OrchestraHit		
0	35	56	XG OrchestraHit2		
0	64	56	XG Impact		
0	0	57	XG Trumpet	BRASS	
0	16	57	XG Trumpet2		
0	17	57	XG BriteTrumpet		
0	32	57	XG WarmTrumpet		
0	0	58	XG Trombone		
0	18	58	XG Trombone2		

Voice Number			Voice Name	Category	
MSB	LSB	PRG			
0	0	59	XG Tuba	BRASS	
0	16	59	XG Tuba2		
0	0	60	XG MutedTrumpet		
0	0	61	XG FrenchHorn		
0	6	61	XG FrHornSolo		
0	32	61	XG FrenchHorn2		
0	37	61	XG HornOrchestra		
0	0	62	XG BrassSection		
0	35	62	XG Tp&TbSection		
0	40	62	XG BrassSection2		
0	41	62	XG HighBrass		
0	42	62	XG MellowBrass		
0	0	63	XG SynthBrass1		
0	12	63	XG QuackBrass		
0	20	63	XG ResoSynBrass		
0	24	63	XG PolyBrass		
0	27	63	XG SynthBrass3		
0	32	63	XG JumpBrass		
0	45	63	XG AnaVel.Brass1		
0	64	63	XG AnalogBrass1		
0	0	64	XG SynthBrass2		
0	18	64	XG SoftBrass		
0	40	64	XG SynthBrass4		
0	41	64	XG ChoirBrass		
0	45	64	XG AnaVel.Brass2		
0	64	64	XG AnalogBrass2		
0	0	65	XG SopranoSax		REED
0	0	66	XG AltoSax		
0	40	66	XG SaxSection		
0	43	66	XG HyperAltoSax		
0	0	67	XG TenorSax		
0	40	67	XG BreathyTenor		
0	41	67	XG SoftTenorSax		
0	64	67	XG TenorSax2		
0	0	68	XG BaritoneSax		
0	0	69	XG Oboe		
0	0	70	XG EnglishHorn		
0	0	71	XG Bassoon		
0	0	72	XG Clarinet		
0	0	73	XG Piccolo	PIPE	
0	0	74	XG Flute		
0	0	75	XG Recorder		
0	0	76	XG PanFlute		
0	0	77	XG BlownBottle		
0	0	78	XG Shakuhachi		
0	0	79	XG Whistle		
0	0	80	XG Ocarina		
0	0	81	XG SquareLead	SYNTH LEAD	
0	6	81	XG SquareLead2		
0	8	81	XG LMSquare		
0	18	81	XG Hollow		
0	19	81	XG Shroud		
0	64	81	XG Mellow		
0	65	81	XG SoloSine		
0	66	81	XG SineLead		
0	0	82	XG SawtoothLead		
0	6	82	XG SawtoothLead2		
0	8	82	XG ThickSaw		

Voice Number			Voice Name	Category	
MSB	LSB	PRG			
0	18	82	XG DynamicSaw	SYNTH LEAD	
0	19	82	XG DigitalSaw		
0	20	82	XG BigLead		
0	24	82	XG HeavySynth		
0	25	82	XG WaspySynth		
0	40	82	XG PulseSaw		
0	41	82	XG Dr.Lead		
0	45	82	XG VelocityLead		
0	96	82	XG Seq.Analog		
0	0	83	XG CalliopeLead		
0	65	83	XG PurePad		
0	0	84	XG ChiffLead		
0	64	84	XG Rubby		
0	0	85	XG CharangLead		
0	64	85	XG DistortedLead		
0	65	85	XG WireLead		
0	0	86	XG VoiceLead		
0	24	86	XG SynthAahs		
0	64	86	XG VoxLead		
0	0	87	XG FifthsLead		
0	35	87	XG BigFive		
0	0	88	XG Bass&Lead		
0	16	88	XG Big&Low		
0	64	88	XG Fat&Perky		
0	65	88	XG SoftWhirl		
0	0	89	XG NewAgePad		SYNTH PAD
0	64	89	XG Fantasy		
0	0	90	XG WarmPad		
0	16	90	XG ThickPad		
0	17	90	XG SoftPad		
0	18	90	XG SinePad		
0	64	90	XG HornPad		
0	65	90	XG RotaryStrings		
0	0	91	XG PolySynthPad		
0	64	91	XG PolyPad80		
0	65	91	XG ClickPad		
0	66	91	XG AnalogPad		
0	67	91	XG SquarePad		
0	0	92	XG ChoirPad		
0	64	92	XG Heaven		
0	66	92	XG Itopia		
0	67	92	XG CCPad		
0	0	93	XG BowedPad		
0	64	93	XG Glacier		
0	65	93	XG GlassPad		
0	0	94	XG MetallicPad		
0	64	94	XG TinePad		
0	65	94	XG PanPad		
0	0	95	XG HaloPad		
0	0	96	XG SweepPad		
0	20	96	XG Shwimmer		
0	27	96	XG Converge		
0	64	96	XG PolarPad		
0	66	96	XG Celestial		
0	0	97	XG Rain	SYNTH EFFECTS	
0	45	97	XG Clavi.Pad		
0	64	97	XG HarmoRain		
0	65	97	XG AfricanWind		

Voice Number			Voice Name	Category
MSB	LSB	PRG		
0	66	97	XG Carib	SYNTH EFFECTS
0	0	98	XG SoundTrack	
0	27	98	XG Prologue	
0	64	98	XG Ancestral	
0	0	99	XG Crystal	
0	12	99	XG SynthDr.Comp	
0	14	99	XG Popcorn	
0	18	99	XG TinyBells	
0	35	99	XG RoundGlocken	
0	40	99	XG GlockenChime	
0	41	99	XG ClearBells	
0	42	99	XG ChorusBells	
0	64	99	XG SynthMallet	
0	65	99	XG SoftCrystal	
0	66	99	XG LoudGlocken	
0	67	99	XG ChristmasBel	
0	68	99	XG VibeBells	
0	69	99	XG DigitalBells	
0	70	99	XG AirBells	
0	71	99	XG BellHarp	
0	72	99	XG Gamelimba	
0	0	100	XG Atmosphere	
0	18	100	XG WarmAtmos.	
0	19	100	XG HollowRelease	
0	40	100	XG NylonEl.Piano	
0	64	100	XG NylonHarp	
0	65	100	XG HarpVox	
0	66	100	XG Atmos.Pad	
0	67	100	XG Planet	
0	0	101	XG Brightness	
0	64	101	XG FantasyBells	
0	96	101	XG Smokey	
0	0	102	XG Goblins	
0	64	102	XG GoblinsSynth	
0	65	102	XG Creeper	
0	66	102	XG RingPad	
0	67	102	XG Ritual	
0	68	102	XG ToHeaven	
0	70	102	XG Night	
0	71	102	XG Glisten	
0	96	102	XG BellChoir	
0	0	103	XG Echoes	
0	8	103	XG Echoes2	
0	14	103	XG EchoPan	
0	64	103	XG EchoBells	
0	65	103	XG BigPan	
0	66	103	XG SynthPiano	
0	67	103	XG Creation	
0	68	103	XG StarDust	
0	69	103	XG Reso&Panning	
0	0	104	XG Sci-Fi	
0	64	104	XG Starz	
0	0	105	XG Sitar	ETHNIC
0	32	105	XG DetunedSitar	
0	35	105	XG Sitar2	
0	96	105	XG Tambra	
0	97	105	XG Tamboura	
0	0	106	XG Banjo	

Voice Number			Voice Name	Category	
MSB	LSB	PRG			
0	28	106	XG MutedBanjo	ETHNIC	
0	96	106	XG Rabab		
0	97	106	XG Gopichant		
0	98	106	XG Oud		
0	0	107	XG Shamisen		
0	0	108	XG Koto		
0	96	108	XG Taisho-kin		
0	97	108	XG Kanoon		
0	0	109	XG Kalimba		
0	0	110	XG Bagpipe		
0	0	111	XG Fiddle		
0	0	112	XG Shanai		
0	64	112	XG Shanai2		
0	96	112	XG Pungi		
0	97	112	XG Hichiriki		
0	0	113	XG TinkleBell		
0	96	113	XG Bonang		
0	97	113	XG Altair		
0	98	113	XG GamelanGongs		
0	99	113	XG StereoGamelan		
0	100	113	XG RamaCymbal		
0	101	113	XG AsianBells		
0	0	114	XG Agogo		PERCUSSION
0	0	115	XG SteelDrums		
0	97	115	XG GlassPerc.		
0	98	115	XG ThaiBells		
0	0	116	XG Woodblock		
0	96	116	XG Castanets		
0	0	117	XG TaikoDrum		
0	96	117	XG GranCassa		
0	0	118	XG MelodicTom		
0	64	118	XG MelodicTom2		
0	65	118	XG RealTom		
0	66	118	XG RockTom		
0	0	119	XG SynthDrum		
0	64	119	XG AnalogTom		
0	65	119	XG ElectroPerc.		
0	0	120	XG Rev.Cymbal		
0	0	121	XG GtrFretNoise		
0	0	122	XG BreathNoise		
0	0	123	XG Seashore		
0	0	124	XG BirdTweet		
0	0	125	XG TelephoneRing		
0	0	126	XG Helicopter		
0	0	127	XG Applause		
0	0	128	XG Gunshot		
64	0	1	XG CuttingNoise		
64	0	2	XG CuttingNoise2		
64	0	4	XG StringSlap		
64	0	17	XG Fl.KeyClick		
64	0	33	XG Shower		
64	0	34	XG Thunder		
64	0	35	XG Wind		
64	0	36	XG Stream		
64	0	37	XG Bubble		
64	0	38	XG Feed		
64	0	49	XG Dog		
64	0	50	XG Horse		

Voice Number			Voice Name	Category
MSB	LSB	PRG		
64	0	51	XG BirdTweet2	SOUND EFFECTS
64	0	55	XG Ghost	
64	0	56	XG Maou	
64	0	65	XG PhoneCall	
64	0	66	XG DoorSqueak	
64	0	67	XG DoorSlam	
64	0	68	XG ScratchCut	
64	0	69	XG ScratchSplit	
64	0	70	XG WindChime	
64	0	71	XG TelephoneRing2	
64	0	81	XG CarEngineIgn	
64	0	82	XG CarTiresSql	
64	0	83	XG CarPassing	
64	0	84	XG CarCrash	
64	0	85	XG Siren	
64	0	86	XG Train	
64	0	87	XG JetPlane	
64	0	88	XG Starship	
64	0	89	XG Burst	
64	0	90	XG RollrCoaster	
64	0	91	XG Submarine	
64	0	97	XG Laugh	
64	0	98	XG Scream	
64	0	99	XG Punch	
64	0	100	XG Heartbeat	
64	0	101	XG FootSteps	
64	0	113	XG MachineGun	
64	0	114	XG LaserGun	
64	0	115	XG Explosion	
64	0	116	XG Firework	
127	0	1	Standard Kit 1	DRUM *Refer to Drum Kit Map
127	0	2	Standard Kit 2	
127	0	5	Hit Kit	
127	0	9	Room Kit	
127	0	17	Rock Kit	
127	0	25	Electro Kit	
127	0	26	Analog Kit	
127	0	28	Dance Kit	
127	0	33	Jazz Kit	
127	0	41	Brush Kit	
127	0	49	Symphony Kit	
126	0	1	SFX Kit 1	
126	0	2	SFX Kit 2	

XG Drum Map

MSB/LSB/PC Note	Standard Kit 1 (127/0/1)	Key Off	Standard Kit 2 (127/0/2)	Key Off	Hit Kit (127/0/5)	Key Off	Room Kit (127/0/9)	Key Off	Rock Kit (127/0/17)	Key Off	Electro Kit (127/0/25)	Key Off
12												
13	Surdo Mute		Surdo Mute		Surdo Mute		Surdo Mute		Surdo Mute		Surdo Mute	
14	Surdo Open		Surdo Open		Surdo Open		Surdo Open		Surdo Open		Surdo Open	
15	Hi Q		Hi Q		Hi Q		Hi Q		Hi Q		Hi Q	
16	Whip Slap		Whip Slap		Whip Slap		Whip Slap		Whip Slap		Whip Slap	
17	Scratch H		Scratch H		Scratch H		Scratch H		Scratch H		Scratch H	
18	Scratch L		Scratch L		Scratch L		Scratch L		Scratch L		Scratch L	
19	Finger Snap		Finger Snap		Finger Snap		Finger Snap		Finger Snap		Finger Snap	
20	Click Noise		Click Noise		Click Noise		Click Noise		Click Noise		Click Noise	
21	Metronome Click		Metronome Click		Metronome Click		Metronome Click		Metronome Click		Metronome Click	
22	Metronome Bell		Metronome Bell		Metronome Bell		Metronome Bell		Metronome Bell		Metronome Bell	
23	Seq Click L		Seq Click L		Seq Click L		Seq Click L		Seq Click L		Seq Click L	
24	Seq Click H		Seq Click H		Seq Click H		Seq Click H		Seq Click H		Seq Click H	
25	Brush Tap		Brush Tap		Brush Tap		Brush Tap		Brush Tap		Brush Tap	
26	Brush Swirl	○	Brush Swirl	○	Brush Swirl	○	Brush Swirl	○	Brush Swirl	○	Brush Swirl	○
27	Brush Slap		Brush Slap		Brush Slap		Brush Slap		Brush Slap		Brush Slap	
28	Brush Tap Swirl	○	Brush Tap Swirl	○	Brush Tap Swirl	○	Brush Tap Swirl	○	Brush Tap Swirl	○	Reverse Cymbal	○
29	Snare Roll	○	Snare Roll	○	Snare Roll	○	Snare Roll	○	Snare Roll	○	Snare Roll	○
30	Castanet		Castanet		Castanet		Castanet		Castanet		Hi Q 2	
31	Snare Soft		Snare Soft 2		Snare Electro		Snare Soft		Snare Noisy		Snare Snap Elec	
32	Sticks		Sticks		Sticks		Sticks		Sticks		Sticks	
33	Kick Soft		Kick Soft		Kick Tight L		Kick Soft		Kick Soft		Kick 3	
34	Open Rim Shot		Open Rim Shot H		Snare Pitched		Open Rim Shot		Open Rim Shot		Open Rim Shot	
35	Kick Tight		Kick Tight		Kick Wet		Kick Tight		Kick 2		Kick Gate	
36	Kick		Kick Short		Kick Tight H		Kick		Kick Gate		Kick Gate Heavy	
37	Side Stick		Side Stick Light		Stick Ambient		Side Stick		Side Stick		Side Stick	
38	Snare		Snare Short		Snare Ambient		Snare Snappy		Snare Rock		Snare Noisy 2	
39	Hand Clap		Hand Clap		Hand Clap		Hand Clap		Hand Clap		Hand Clap	
40	Snare Tight		Snare Tight H		Snare Tight 2		Snare Tight Snap		Snare Rock Tight		Snare Noisy 3	
41	Floor Tom L		Floor Tom L		Hybrid Tom 1		Tom Room 1		Tom Rock 1		Tom Electro 1	
42	Hi-Hat Closed		Hi-Hat Closed		Hi-Hat Closed 2		Hi-Hat Closed		Hi-Hat Closed		Hi-Hat Closed	
43	Floor Tom H		Floor Tom H		Hybrid Tom 2		Tom Room 2		Tom Rock 2		Tom Electro 2	
44	Hi-Hat Pedal		Hi-Hat Pedal		Hi-Hat Pedal 2		Hi-Hat Pedal		Hi-Hat Pedal		Hi-Hat Pedal	
45	Low Tom		Low Tom		Hybrid Tom 3		Tom Room 3		Tom Rock 3		Tom Electro 3	
46	Hi-Hat Open		Hi-Hat Open		Hi-Hat Open 2		Hi-Hat Open		Hi-Hat Open		Hi-Hat Open	
47	Mid Tom L		Mid Tom L		Hybrid Tom 4		Tom Room 4		Tom Rock 4		Tom Electro 4	
48	Mid Tom H		Mid Tom H		Hybrid Tom 5		Tom Room 5		Tom Rock 5		Tom Electro 5	
49	Crash Cymbal 1		Crash Cymbal 1		Crash Cymbal 1		Crash Cymbal 1		Crash Cymbal 1		Crash Cymbal 1	
50	High Tom		High Tom		Hybrid Tom 6		Tom Room 6		Tom Rock 6		Tom Electro 6	
51	Ride Cymbal 1		Ride Cymbal 1		Ride Cymbal 1		Ride Cymbal 1		Ride Cymbal 1		Ride Cymbal 1	
52	Chinese Cymbal		Chinese Cymbal		Chinese Cymbal		Chinese Cymbal		Chinese Cymbal		Chinese Cymbal	
53	Ride Cymbal Cup		Ride Cymbal Cup		Ride Cymbal Cup		Ride Cymbal Cup		Ride Cymbal Cup		Ride Cymbal Cup	
54	Tambourine		Tambourine		Tambourine Light		Tambourine		Tambourine		Tambourine	
55	Splash Cymbal		Splash Cymbal		Splash Cymbal		Splash Cymbal		Splash Cymbal		Splash Cymbal	
56	Cowbell		Cowbell		Cowbell		Cowbell		Cowbell		Cowbell	
57	Crash Cymbal 2		Crash Cymbal 2		Crash Cymbal 2		Crash Cymbal 2		Crash Cymbal 2		Crash Cymbal 2	
58	Vibraslap		Vibraslap		Vibraslap		Vibraslap		Vibraslap		Vibraslap	
59	Ride Cymbal 2		Ride Cymbal 2		Ride Cymbal 2		Ride Cymbal 2		Ride Cymbal 2		Ride Cymbal 2	
60	Bongo H		Bongo H		Bongo H		Bongo H		Bongo H		Bongo H	
61	Bongo L		Bongo L		Bongo L		Bongo L		Bongo L		Bongo L	
62	Conga H Mute		Conga H Mute		Conga H Mute		Conga H Mute		Conga H Mute		Conga H Mute	
63	Conga H Open		Conga H Open		Conga H Open		Conga H Open		Conga H Open		Conga H Open	
64	Conga L		Conga L		Conga L		Conga L		Conga L		Conga L	
65	Timbale H		Timbale H		Timbale H		Timbale H		Timbale H		Timbale H	
66	Timbale L		Timbale L		Timbale L		Timbale L		Timbale L		Timbale L	
67	Agogo H		Agogo H		Agogo H		Agogo H		Agogo H		Agogo H	
68	Agogo L		Agogo L		Agogo L		Agogo L		Agogo L		Agogo L	
69	Cabasa		Cabasa		Cabasa		Cabasa		Cabasa		Cabasa	
70	Maracas		Maracas		Maracas		Maracas		Maracas		Maracas	
71	Samba Whistle H	○	Samba Whistle H	○	Samba Whistle H	○	Samba Whistle H	○	Samba Whistle H	○	Samba Whistle H	○
72	Samba Whistle L	○	Samba Whistle L	○	Samba Whistle L	○	Samba Whistle L	○	Samba Whistle L	○	Samba Whistle L	○
73	Guiro Short		Guiro Short		Guiro Short		Guiro Short		Guiro Short		Guiro Short	
74	Guiro Long	○	Guiro Long	○	Guiro Long	○	Guiro Long	○	Guiro Long	○	Guiro Long	○
75	Claves		Claves		Claves		Claves		Claves		Claves	
76	Wood Block H		Wood Block H		Wood Block H		Wood Block H		Wood Block H		Wood Block H	
77	Wood Block L		Wood Block L		Wood Block L		Wood Block L		Wood Block L		Wood Block L	
78	Cuica Mute		Cuica Mute		Cuica Mute		Cuica Mute		Cuica Mute		Scratch H 2	
79	Cuica Open		Cuica Open		Cuica Open		Cuica Open		Cuica Open		Scratch L 2	
80	Triangle Mute		Triangle Mute		Triangle Mute		Triangle Mute		Triangle Mute		Triangle Mute	
81	Triangle Open		Triangle Open		Triangle Open		Triangle Open		Triangle Open		Triangle Open	
82	Shaker		Shaker		Shaker		Shaker		Shaker		Shaker	
83	Jingle Bells		Jingle Bells		Jingle Bells		Jingle Bells		Jingle Bells		Jingle Bells	
84	Bell Tree		Bell Tree		Bell Tree		Bell Tree		Bell Tree		Bell Tree	
85	No Sound											
86												
87												
88												
89												
90												
91												

MSB/LSB/ PCNote	Analog Kit (127/0/26)	Key Off	Dance Kit (127/0/28)	Key Off	Jazz Kit (127/0/33)	Key Off	Brush Kit (127/0/41)	Key Off	Symphony Kit (127/0/49)	Key Off	SFX Kit 1 (126/0/1)	Key Off
12												
13	Surdo Mute		Kick Dance 1		Surdo Mute		Surdo Mute		Surdo Mute			
14	Surdo Open		Kick Dance 2		Surdo Open		Surdo Open		Surdo Open			
15	Hi Q		Hi Q		Hi Q		Hi Q		Hi Q			
16	Whip Slap		Whip Slap	○	Whip Slap		Whip Slap		Whip Slap			
17	Scratch H		Scratch Dance 1	○	Scratch H		Scratch H		Scratch H			
18	Scratch L		Scratch Dance 2	○	Scratch L		Scratch L		Scratch L			
19	Finger Snap		Finger Snap		Finger Snap		Finger Snap		Finger Snap			
20	Click Noise		Click Noise		Click Noise		Click Noise		Click Noise			
21	Metronome Click		Dance Perc 1		Metronome Click		Metronome Click		Metronome Click			
22	Metronome Bell		Reverse Dance 1		Metronome Bell		Metronome Bell		Metronome Bell			
23	Seq Click L		Dance Perc 2		Seq Click L		Seq Click L		Seq Click L			
24	Seq Click H		Hi Q Dance 1		Seq Click H		Seq Click H		Seq Click H			
25	Brush Tap		Snare Analog 3		Brush Tap		Brush Tap		Brush Tap			
26	Brush Swirl	○	Vinyl Noise	○	Brush Swirl	○	Brush Swirl	○	Brush Swirl	○		
27	Brush Slap		Snare Analog 4		Brush Slap		Brush Slap		Brush Slap			
28	Reverse Cymbal	○	Reverse Cymbal	○	Brush Tap Swirl	○	Brush Tap Swirl	○	Brush Tap Swirl	○		
29	Snare Roll	○	Reverse Dance 2	○	Snare Roll	○	Snare Roll	○	Snare Roll	○		
30	Hi Q 2		Hi Q 2		Castanet		Castanet		Castanet			
31	Snare Noisy 4		Snare Techno		Snare Jazz H		Brush Slap 2		Snare Soft			
32	Sticks		Snare Dance 1		Sticks		Sticks		Sticks			
33	Kick 3		Kick Techno Q		Kick Soft		Kick Soft		Kick Soft 2			
34	Open Rim Shot		Rim Gate		Open Rim Shot		Open Rim Shot		Open Rim Shot			
35	Kick Anlg Short		Kick Techno L		Kick Tight		Kick Tight		Gran Cassa			
36	Kick Analog		Kick Techno		Kick Jazz		Kick Jazz		Gran Cassa Mute		Cutting Noise 1	○
37	Side Stick Anlg		Side Stick Anlg		Side Stick Light		Side Stick Light		Side Stick		Cutting Noise 2	○
38	Snare Analog		Snare Clap		Snare Jazz L		Brush Slap 3		Band Snare			
39	Hand Clap		Dance Clap		Hand Clap		Hand Clap		Hand Clap		String Slap	○
40	Snare Analog 2		Snare Dry		Snare Jazz M		Brush Tap 2		Band Snare 2			
41	Tom Analog 1		Tom Dance 1		Floor Tom L		Tom Brush 1		Floor Tom L			
42	Hat Close Analog		Hi-Hat Closed 3		Hi-Hat Closed		Hi-Hat Closed		Hi-Hat Closed			
43	Tom Analog 2		Tom Dance 2		Floor Tom H		Tom Brush 2		Floor Tom H			
44	Hat Close Anlg 2		Hat Close Anlg 3		Hi-Hat Pedal		Hi-Hat Pedal		Hi-Hat Pedal			
45	Tom Analog 3		Tom Dance 3		Low Tom		Tom Brush 3		Low Tom			
46	Hat Open Analog		Hi-Hat Open 3		Hi-Hat Open		Hi-Hat Open		Hi-Hat Open			
47	Tom Analog 4		Tom Dance 4		Mid Tom L		Tom Brush 4		Mid Tom L			
48	Tom Analog 5		Tom Dance 5		Mid Tom H		Tom Brush 5		Mid Tom H			
49	Crash Analog		Crash Analog		Crash Cymbal 1		Crash Cymbal 1		Hand Cymbal			
50	Tom Analog 6		Tom Dance 6		High Tom		Tom Brush 6		High Tom			
51	Ride Cymbal 1		Ride Cymbal 1		Ride Cymbal 1		Ride Cymbal 1		Hand Cymbal S			
52	Chinese Cymbal		Chinese Cymbal		Chinese Cymbal		Chinese Cymbal		Chinese Cymbal		Flute Key Click	○
53	Ride Cymbal Cup		Ride Cymbal Cup		Ride Cymbal Cup		Ride Cymbal Cup		Ride Cymbal Cup			
54	Tambourine		Tambourine Anlg		Tambourine		Tambourine		Tambourine			
55	Splash Cymbal		Splash Cymbal		Splash Cymbal		Splash Cymbal		Splash Cymbal			
56	Cowbell Analog		Cowbell Dance		Cowbell		Cowbell		Cowbell			
57	Crash Cymbal 2		Crash Cymbal 2		Crash Cymbal 2		Crash Cymbal 2		Hand Cymbal 2			
58	Vibraslap		Vibraslap Analog		Vibraslap		Vibraslap		Vibraslap			
59	Ride Cymbal 2		Ride Analog		Ride Cymbal 2		Ride Cymbal 2		Hand Cymbal 2 S			
60	Bongo H		Bongo Analog H		Bongo H		Bongo H		Bongo H			
61	Bongo L		Bongo Analog L		Bongo L		Bongo L		Bongo L			
62	Conga Analog H		Conga Analog H		Conga H Mute		Conga H Mute		Conga H Mute			
63	Conga Analog M		Conga Analog M		Conga H Open		Conga H Open		Conga H Open			
64	Conga Analog L		Conga Analog L		Conga L		Conga L		Conga L			
65	Timbale H		Timbale H		Timbale H		Timbale H		Timbale H			
66	Timbale L		Timbale L		Timbale L		Timbale L		Timbale L			
67	Agogo H		Agogo H		Agogo H		Agogo H		Agogo H			
68	Agogo L		Agogo L		Agogo L		Agogo L		Agogo L		Shower	○
69	Cabasa		Cabasa		Cabasa		Cabasa		Cabasa		Thunder	○
70	Maracas 2		Maracas 2		Maracas		Maracas		Maracas		Wind	○
71	Samba Whistle H	○	Samba Whistle H	○	Samba Whistle H	○	Samba Whistle H	○	Samba Whistle H	○	Stream	○
72	Samba Whistle L	○	Samba Whistle L	○	Samba Whistle L	○	Samba Whistle L	○	Samba Whistle L	○	Bubble	○
73	Guiro Short		Guiro Short		Guiro Short		Guiro Short		Guiro Short		Feed	○
74	Guiro Long	○	Guiro Long	○	Guiro Long	○	Guiro Long	○	Guiro Long	○		
75	Claves 2		Claves 2		Claves		Claves		Claves			
76	Wood Block H		Dance Perc 3		Wood Block H		Wood Block H		Wood Block H			
77	Wood Block L		Dance Perc 4	○	Wood Block L		Wood Block L		Wood Block L			
78	Scratch H 2		Dance Breath 1		Cuica Mute		Cuica Mute		Cuica Mute			
79	Scratch L 2		Dance Breath 2	○	Cuica Open		Cuica Open		Cuica Open			
80	Triangle Mute		Triangle Mute		Triangle Mute		Triangle Mute		Triangle Mute			
81	Triangle Open		Triangle Open		Triangle Open		Triangle Open		Triangle Open			
82	Shaker		Shaker		Shaker		Shaker		Shaker			
83	Jingle Bells		Jingle Bells		Jingle Bells		Jingle Bells		Jingle Bells			
84	Bell Tree		Bell Tree		Bell Tree		Bell Tree		Bell Tree		Dog	○
85											Horse	○
86											Bird Tweet	○
87												
88												
89												
90											Ghost	○
91											Maou	○

MSB/LSB/ PCNote	SFX Kit 2 (126/0/2)	Key Off
12		
13		
14		
15		
16		
17		
18		
19		
20		
21		
22		
23		
24		
25		
26		
27		
28		
29		
30		
31		
32		
33		
34		
35		
36	Phone Call	○
37	Door Squeak	○
38	Door Slam	○
39	Scratch Cut	○
40	Scratch H 3	○
41	Wind Chime	○
42	Telephone Ring	○
43		
44		
45		
46		
47		
48		
49		
50		
51		
52	CarEngnIgnition	○
53	Car Tires Squeal	○
54	Car Passing	○
55	Car Crash	○
56	Siren	○
57	Train	○
58	Jet Plane	○
59	Starship	○
60	Burst	○
61	Roller Coaster	○
62	Submarine	○
63		
64		
65		
66		
67		
68	Laugh	○
69	Scream	○
70	Punch	○
71	Heart Beat	○
72	Foot Steps	○
73		
74		
75		
76		
77		
78		
79		
80		
81		
82		
83		
84	Machine Gun	○
85	Laser Gun	○
86	Explosion	○
87	Firework	○
88		
89		
90		
91		

MIDI Data Format

1. Channel Messages

1.1 DDK Mode

“X” indicates “Not available.”
“O” indicates “Available.”

Code (Hexadecimal)	Function	Receive	Transmit	Remarks
8n, nn, 00-7F	Note Off	1ch 2ch 3ch (4ch)* 5-14ch 15ch	X X X X X X	UK LK PEDAL LEAD 1 XG Keyboard Percussion
9n, nn, 00 9n, nn, 01-7F	Note Off Note On	1ch 2ch 3ch (4ch)* 5-14ch 15ch	(1ch)* (2ch)* (3ch)* X X X	UK LK PEDAL LEAD 1 XG Keyboard Percussion
An, nn, 00-7F	Polyphonic After Touch	5-14ch	X	XG
Bn, 00, 00-7F Bn, 20, 00-7F	Bank select	5-14ch	X	XG
Bn, 01, 00-7F	Modulation	5-14ch	X	XG
Bn, 04, 00-7F	2nd Expression	16ch (4ch)*	16ch (4ch)**	Control LEAD 1
Bn, 05, 00-7F	Portamento Time	5-14ch	X	XG
Bn, 06, 00-7F Bn, 26, 00-7F	Data Entry	5-14ch	X	XG
Bn, 07, 00-7F	Volume	5-14ch	X	XG
Bn, 0A, 00-7F	Pan	5-14ch	X	XG
Bn, 0B, 00-7F	Expression	16ch 5-14ch	(16ch)*	Control XG
Bn, 40, 00-7F	Sustain Hold	16ch 5-14ch	(16ch)* X	Control XG
Bn, 41, 00-7F	Portamento	5-14ch	X	XG
Bn, 42, 00-7F	Sostenuto	5-14ch	X	XG
Bn, 43, 00-7F	Soft Pedal	5-14ch	X	XG
Bn, 47, 00-7F	Resonance	5-14ch	X	XG
Bn, 48, 00-7F	Release Time	5-14ch	X	XG
Bn, 49, 00-7F	Attack Time	5-14ch	X	XG
Bn, 4A, 00-7F	Brightness	5-14ch	X	XG
Bn, 4B, 00-7F	Decay Time	5-14ch	X	XG
Bn, 4C, 00-7F	Vibrato Rate	5-14ch	X	XG
Bn, 4D, 00-7F	Vibrato Depth	5-14ch	X	XG
Bn, 4E, 00-7F	Vibrato Delay	5-14ch	X	XG
Bn, 54, 00-7F	Portamento Control	5-14ch	X	XG
Bn, 5B, 00-7F	Reverb Send Level	5-14ch	X	XG
Bn, 5D, 00-7F	Chorus Send Level	5-14ch	X	XG
Bn, 5E, 00-7F	Variation Effect Send Level	5-14ch	X	XG
Bn, 60, 00-7F Bn, 61, 00-7F	Data Increment Data Decrement	5-14ch	X	XG
Bn, 62, 00-7F Bn, 63, 00-7F	NRPN LSB NRPN MSB	5-14ch	X	XG
Bn, 64, 00-7F Bn, 65, 00-7F	RPN LSB RPN MSB	5-14ch	X	XG

Code (Hexadecimal)	Function	Receive	Transmit	Remarks
Bn, 78, 00 Bn, 79, 00 Bn, 7B, 00 Bn, 7C, 00 Bn, 7D, 00 Bn, 7E, 00 Bn, 7F, 00	All Sound Off Reset All Controllers All Note Off Omni Off Omni On Mono Poly	5-14ch	×	XG
Cn, nn	Program Change	5-14ch 16ch	×	XG Control
Dn, 00-7F	After Touch	1ch 2ch 3ch (4ch)* 5-14ch	(1ch)* (2ch)* ×	UK LK PEDAL LEAD 1 XG
En, 00-7F, 00-7F	Pitch Bend	1ch 2ch (4ch)*	×	UK LK LEAD 1 XG

* Can be changed in the MIDI settings (page 238).

** Can be output when assigned to channel 4.

1.2 XG Mode

Code (Hexadecimal)	Function	Receive	Transmit	Remarks
8n, nn, 00-7F	Note Off	1-16ch	×	
9n, nn, 00 9n, nn, 01-7F	Note On Note Off		(1ch)* (2ch)* (3ch)*	UK LK PEDAL
		1-16ch		
An, nn, 00-7F	Polyphonic After Touch	1-16ch	×	
Bn, 00, 00-7F Bn, 20, 00-7F	Bank select	1-16ch	×	
Bn, 01, 00-7F	Modulation		×	
		1-16ch		
Bn, 04, 00-7F	2nd Expression	×	16ch (4ch)**	Control LEAD 1
Bn, 05, 00-7F	Portamento Time	1-16ch	×	
Bn, 06, 00-7F Bn, 26, 00-7F	Data Entry	1-16ch	×	
Bn, 07, 00-7F	Volume	1-16ch	×	
Bn, 0A, 00-7F	Pan	1-16ch	×	
Bn, 0B, 00-7F	Expression		(16ch)*	Control
		1-16ch		
Bn, 40, 00-7F	Sustain Hold	1-16ch	(16ch)* ×	Control
Bn, 41, 00-7F	Portamento	1-16ch	×	
Bn, 42, 00-7F	Sostenuto	1-16ch	×	
Bn, 43, 00-7F	Soft Pedal	1-16ch	×	
Bn, 47, 00-7F	Resonance	1-16ch	×	
Bn, 48, 00-7F	Release Time	1-16ch	×	
Bn, 49, 00-7F	Attack Time	1-16ch	×	
Bn, 4A, 00-7F	Brightness	1-16ch	×	
Bn, 4B, 00-7F	Decay Time	1-16ch	×	
Bn, 4C, 00-7F	Vibrato Rate	1-16ch	×	
Bn, 4D, 00-7F	Vibrato Depth	1-16ch	×	
Bn, 4E, 00-7F	Vibrato Delay	1-16ch	×	
Bn, 54, 00-7F	Portamento Control	1-16ch	×	

Code (Hexadecimal)	Function	Receive	Transmit	Remarks
Bn, 5B, 00-7F	Reverb Send Level	1-16ch	×	
Bn, 5D, 00-7F	Chorus Send Level	1-16ch	×	
Bn, 5E, 00-7F	Variation Effect Send Level	1-16ch	×	
Bn, 60, 00-7F Bn, 61, 00-7F	Data Increment Data Decrement	1-16ch	×	
Bn, 62, 00-7F Bn, 63, 00-7F	NRPN LSB NRPN MSB	1-16ch	×	
Bn, 64, 00-7F Bn, 65, 00-7F	RPN LSB RPN MSB	1-16ch	×	
Bn, 78, 00 Bn, 79, 00 Bn, 7B, 00 Bn, 7C, 00 Bn, 7D, 00 Bn, 7E, 00 Bn, 7F, 00	All Sound Off Reset All Controllers All Note Off Omni Off Omni On Mono Poly	1-16ch	×	
Cn, 00-7F	Program Change	1-16ch	16ch	Control
Dn, 00-7F	After Touch	1-16ch	(1ch)* (2ch)* ×	UK LK PEDAL
En, 00-7F, 00-7F	Pitch Bend	1-16ch	×	UK LK
			×	
			(1-16ch)*	

* Can be changed in the MIDI settings (page 238).

** Can be output when assigned to channel 4.

2. Realtime Messages

Code (Hexadecimal)	Function	Receive	Transmit	Remarks
F8	Clock	○*	○	
FA	Start	○	○	
FC	Stop	○	○	
FE	Active Sensing	○	○	
FF	Reset	×	×	

* Received only when in the Ext. mode

3. System Exclusive Messages

3.1 Format

Universal Realtime Messages

Code (Hexadecimal)	Message	Receive	Transmit
F0, 7F, 7F, 04, 01, SS, TT, F7 XN	GM2 Master Volume	○	×
F0, 7F, 7F, 04, 03, SS, TT, F7 XN	GM2 Master Fine Tuning	○	×
F0, 7F, 7F, 04, 04, 00, TT, F7 XN	GM2 Master Coarse Tuning	○	×
F0, 7F, 7F, 04, 05, 01, 01, 01, 01, PP, VV, ..., F7 XN	GM2 Reverb Parameter	○	×
F0, 7F, 7F, 04, 05, 01, 01, 01, 01, 02, PP, VV, ..., F7 XN	GM2 Chorus Parameter	○	×
F0, 7F, 7F, 09, 01, 0n, PP, VV, ..., F7 XN	GM2 After Touch Parameter	○	×

Code (Hexadecimal)	Message	Receive	Transmit
F0, 7F, 7F, 09, 03, 0n, CC, PP, VV, ..., F7 XN	GM2 Control Change Parameter	○	×
F0, 7F, 7F, 0A, 01, 0n, KK, CC, PP, VV, ..., F7 XN	GM2 Key-Based Controller	○	×

Universal Non-Realtime Messages

Code (Hexadecimal)	Message	Receive	Transmit
F0, 7E, 7F, 09, 01, F7 XN	GM ON	○	×
F0, 7E, 7F, 09, 03, F7 XN	GM2 ON	○	×
F0, 7E, 7F, 09, 02, F7 XN	GM OFF	○	×
F0, 7E, 7F, 08, 08, JJ, GG, MM, ..data..., F7 XN	GM2 Scale/Octave Tuning	○	×

XG Native

Code (Hexadecimal)	Message	Receive	Transmit
F0, 43, 1N, 4C, AH, AM, AL, ..data..., F7	XG Parameter Change	○	×
F0, 43, 0N, 4C, BH, BL, AH, AM, AL, ..data..., cc, F7	XG Bulk Dump	○	×
F0, 43, 1N, 27, 30, 00, 00, MM, LL, cc, F7	XG Master Tuning	○	×

Clavinova Exclusive

Code (Hexadecimal)	Message	Receive	Transmit
F0, 43, 73, 01, 02, F7 03	Request for Internal Synch. Mode	○	×
	Request for External Synch. Mode	○	×

Message Exclusive

Code (Hexadecimal)	Message	Receive	Transmit
F0, 43, 60, 7A, F7	Rhythm Start	○	×
F0, 43, 60, 7D, F7	Rhythm Stop	○	×

Electone Exclusive

Code (Hexadecimal)	Message	Receive	Transmit
F0, 43, 70, ID, 00, F7	Model ID Data	×	○
F0, 43, 70, 70, 30, F7	Request-to-Send Model ID Data	○	×
F0, 43, 70, 70, 40, nn(*1), 7F, F7 00	Switch ON	○	○
	Switch OFF	○	○
F0, 43, 70, 70, 40, 50, TL, TH, F7	Tempo	○	○
F0, 43, 70, 78, 41, cc, dd, F7(*2)	Panel Switch Events	○	○
F0, 43, 70, 78, 42, 3C, ..data..., F7	Current Registration Data	○	○
F0, 43, 70, 78, 44, ..data..(*3), F7	MIDI Parameters	○	○
F0, 43, 70, 70, 70, nn(*4), F7	MDR	○	×
F0, 43, 70, 70, 73, F7	EL ON	○	×
F0, 43, 70, 70, 78, 00, 00, F7	Bar Signal	×	○

X: don't care N: Device Number ("0" on DDK-7) ID: Model ID (DDK-7 = 52H)

*1. Switches

nn	Switch	Receive	Transmit
45H	Left Footswitch	○	○

*2. Panel Switch Events

MIDI Exclusive Format
F0, 43, 70, 78, 41, cc, dd, F7

Selectors

cc Code	Switch	dd				Remarks
		Receive	Rx Range	Transmit	Tx Range	
0F	Registration Memory [1-16]	○	[00-0F]	×	-	

Volume

cc Code	Switch	dd				Remarks
		Receive	Rx Range	Transmit	Tx Range	
12	Upper Keyboard Voice 1 Volume	○	[00-7F]	○	[00-7F]	Volume Data 00:MAX, 7F:MIN
13	Lower Keyboard Voice 1 Volume	○	[00-7F]	○	[00-7F]	Volume Data 00:MAX, 7F:MIN
14	Upper Keyboard Voice 2 Volume	○	[00-7F]	○	[00-7F]	Volume Data 00:MAX, 7F:MIN
15	Lower Keyboard Voice 2 Volume	○	[00-7F]	○	[00-7F]	Volume Data 00:MAX, 7F:MIN
16	Lead Voice 1 Volume	○	[00-7F]	○	[00-7F]	Volume Data 00:MAX, 7F:MIN
17	Pedal Voice 1 Volume	○	[00-7F]	○	[00-7F]	Volume Data 00:MAX, 7F:MIN
18	Pedal Voice 2 Volume	○	[00-7F]	○	[00-7F]	Volume Data 00:MAX, 7F:MIN
19	Lead Voice 2 Volume	○	[00-7F]	○	[00-7F]	Volume Data 00:MAX, 7F:MIN
1A	Percussion Volume	○	[00-7F]	○	[00-7F]	Volume Data 00:MAX, 7F:MIN
1B	Reverb Depth	○	[00-7F]	○	[00-7F]	Depth Data 00:MAX, 7F:MIN

Organ Flute Voice

cc Code	Switch	dd				Remarks
		Receive	Rx Range	Transmit	Tx Range	
30	Upper Organ Flute Voice [U. ORGAN FLUTES]	○	[00-01]	○	[00-01]	00:OFF, 01:ON
31	Lower Organ Flute Voice [L. ORGAN FLUTES]	○	[00-01]	○	[00-01]	00:OFF, 01:ON

To Lower

cc Code	Switch	dd				Remarks
		Receive	Rx Range	Transmit	Tx Range	
36	Lead Voice 1 To Lower [TO LOWER ▼]	○	[00-01]	○	[00-01]	00:OFF, 01:ON
37	Pedal Voice 1 To Lower [TO LOWER ▲]	○	[00-01]	○	[00-01]	00:OFF, 01:ON
38	Pedal Voice 2 To Lower [TO LOWER ▲]	○	[00-01]	○	[00-01]	00:OFF, 01:ON

Solo Mode

cc Code	Switch	dd				Remarks
		Receive	Rx Range	Transmit	Tx Range	
39	Lead Voice 2 Solo (Knee) [SOLO (FOOT PEDAL)]	○	[00-01]	○	[00-01]	00:OFF, 01:ON

Brilliance

cc	Switch	dd				Remarks
		Receive	Rx Range	Transmit	Tx Range	
42	Upper Keyboard Voice 1 Brilliance	○	[00-06]	×	[00-06]	00:BRILLIANT, 06:MELLOW
43	Lower Keyboard Voice 1 Brilliance	○	[00-06]	×	[00-06]	00:BRILLIANT, 06:MELLOW
44	Upper Keyboard Voice 2 Brilliance	○	[00-06]	×	[00-06]	00:BRILLIANT, 06:MELLOW
45	Lower Keyboard Voice 2 Brilliance	○	[00-06]	×	[00-06]	00:BRILLIANT, 06:MELLOW
46	Lead Voice 1 Brilliance	○	[00-06]	×	[00-06]	00:BRILLIANT, 06:MELLOW
47	Pedal Voice 1 Brilliance	○	[00-06]	×	[00-06]	00:BRILLIANT, 06:MELLOW
48	Pedal Voice 2 Brilliance	○	[00-06]	×	[00-06]	00:BRILLIANT, 06:MELLOW
49	Lead Voice 2 Brilliance	○	[00-06]	×	[00-06]	00:BRILLIANT, 06:MELLOW

Sustain

cc	Switch	dd				Remarks
		Receive	Rx Range	Transmit	Tx Range	
50	Upper Sustain [UPPER (KNEE)]	○	[00-01]	○	[00-01]	00:OFF, 01:ON
51	Lower Sustain [LOWER (KNEE)]	○	[00-01]	○	[00-01]	00:OFF, 01:ON
52	Pedal Sustain [PEDAL]	○	[00-01]	○	[00-01]	00:OFF, 01:ON

Solo Bar

cc	Switch	dd				Remarks
		Receive	Rx Range	Transmit	Tx Range	
59	Solo Bar	○	[00-01]	○	-	00:OFF, 01:ON

Keyboard Percussion

cc	Switch	dd				Remarks
		Receive	Rx Range	Transmit	Tx Range	
5B	Keyboard Percussion [1]	○	[00-01]	○	[00-01]	00:OFF, 01:ON
5C	Keyboard Percussion [2]	○	[00-01]	○	[00-01]	00:OFF, 01:ON

Disable

cc	Switch	dd				Remarks
		Receive	Rx Range	Transmit	Tx Range	
5F	Disable [D.]	○	[00-01]	○	[00-01]	00:OFF, 01:ON

Rotary Speaker

cc	Switch	dd				Remarks
		Receive	Rx Range	Transmit	Tx Range	
60	Rotary Speaker Speed [ROTARY SP SPEED]	○	[00-01]	○	[00-01]	00:OFF, 01:ON

Rhythm Sequence

cc	Switch	dd				Remarks
		Receive	Rx Range	Transmit	Tx Range	
61	Sequence 1 [SEQ.1]	○	[00-01]	○	[00-01]	00:OFF, 01:ON
62	Sequence 2 [SEQ.2]	○	[00-01]	○	[00-01]	00:OFF, 01:ON
63	Sequence 3 [SEQ.3]	○	[00-01]	○	[00-01]	00:OFF, 01:ON
64	Sequence 4 [SEQ.4]	○	[00-01]	○	[00-01]	00:OFF, 01:ON

*3. MIDI Parameter

Voice Section Parameters

Panel Voice Parameters

(Address mm: 0 – 7 = UK1, UK2, LK1, LK2, LEAD 1, LEAD 2, PEDAL 1, PEDAL 2)

MIDI Exclusive Format

F0, 43, 70, 78, 44, hh, mm, ll, ..., F7

Address			Size	Data	Parameter	Data	Receive	Rx Range	Transmit	Tx Range
hh	mm	ll								
10	00-07	00-0D	5	00-7F 00-7F 00 00 00	Voice Assign Number	00-7F 00-7F 00 00 00	○	00-7F 00-7F 00 00 00	○	00-7F 00-7F 00 00 00
10	00-07	10	1	00-0D	Voice Selector Number	00-0D	○	00-0D	○	00-0D
10	00-07	11	1	00-7F	Volume	00:MIN 7F:MAX	○	00-7F	×	-
10	00-07	12	1	00-7F	Reverb (Send Level)	00:MIN 7F:MAX	○	00-7F	○	00-7F
10	00-07	13	1	00-7F	Brilliance	00:BRILLIANT 40:CENTER 7F:MELLOW	○	00-7F	×	-
10	00-07	14	1	00-04	Feet	00:PRESET 01:16' 02:8' 03:4' 04:2'	○	00-7F	○	00-04
10	00-07	15	1	00-7F	Pan	00:LEFT 40:CENTER 7F:RIGHT	○	00-7F	○	08-78
10	00-07	16	1	00-7F	Touch Tone Initial Touch	00:MIN 7F:MAX	○	00-7F	○	00-7F
10	00-07	17	1	00-7F	Touch Tone After Touch	00:MIN 7F:MAX	○	00-7F	○	00-7F
10	00-07	18	1	00-7F	Pitch After Touch	00:NARROW 7F:WIDE	○	00-7F	○	32-4E
10	00-07	19	1	00-7F	User Vibrato	00:PRESET 01:USER	○	00-7F	○	00-01
10	00-07	1A	1	00-7F	Vibrato Delay	00:SHORT 7F:LONG	○	00-7F	○	02-1A
10	00-07	1B	1	00-7F	Vibrato Depth	00:MIN 7F:MAX	○	00-7F	○	00-54
10	00-07	1C	1	00-7F	Vibrato Speed	00:SLOW 7F:FAST	○	00-7F	○	3C-6C
10	00-05	1D	1	00-7F	Pitch Horizontal Touch	00:NARROW 7F:WIDE	○	00-7F	○	00-7F
10	00-07	1E	1	00-7F	Touch Vibrato (On/Off)	00:OFF 7F:ON	○	00-7F	○	00-7F
10	04-07	1F	1	00-7F	TO LOWER▼/▲/SOLO (KNEE)	00:OFF 01:ON	○	00-7F	×	-
10	04-05	20	1	00-02	Slide (On/Foot Pedal/Off)	00:OFF 01:ON 02:Foot Pedal	○	00-02	○	00-02
10	04-05	21	1	00-7F	Slide Time	00:FAST 7F:SLOW	○	00-7F	○	02-7F
10	00-07	22	1	00-7F	Tune/Detune	00:Down 40:Center 7F:Up	○	00-7F	○	00-7F
10	00-01/ 04-07	23	1	00-7F	2nd Expression Pitch Bend	00:OFF 01:ON	○	00-7F	○	00-01
10	00-05	24	1	00-7F	Footswitch Glide Control	00:OFF 01:ON	○	00-7F	○	00-01
10	00-07	25	1	3A-46	Transpose	3A:KeyDown 40:Normal 46:KeyUp	○	3A-46	○	3A-46
10	06-07	28	1	00-7F	Poly (On/Off)	00:Mono 01:Poly	○	00-7F	○	00-01
10	05	29	1	00-7F	Priority (Last/Top)	00:TOP 01:LAST	○	00-7F	○	00-01
10	00-07	2A	1	00-7F	Volume Mute	00:Mute OFF 01:Mute ON	○	00-7F	○	00-01

Address			Size	Data	Parameter	Data	Receive	Rx Range	Transmit	Tx Range
hh	mm	ll								
10	00-07	40	3	00 00-7F 00-7F	Effect 1 Type MSB/LSB	00 00-7F 00-7F	○	00 00-7F 00-7F	○	00 00-7F 00-7F
10	00-07	41	2	0000-7F7F	Effect 1 Parameter 1 MSB/LSB	0000-7F7F	○	0000-7F7F	○	0000-7F7F
10	00-07	42	2	0000-7F7F	Effect 1 Parameter 2 MSB/LSB	0000-7F7F		0000-7F7F		0000-7F7F
10	00-07	43	2	0000-7F7F	Effect 1 Parameter 3 MSB/LSB	0000-7F7F		0000-7F7F		0000-7F7F
10	00-07	44	2	0000-7F7F	Effect 1 Parameter 4 MSB/LSB	0000-7F7F		0000-7F7F		0000-7F7F
10	00-07	45	2	0000-7F7F	Effect 1 Parameter 5 MSB/LSB	0000-7F7F		0000-7F7F		0000-7F7F
10	00-07	46	2	0000-7F7F	Effect 1 Parameter 6 MSB/LSB	0000-7F7F		0000-7F7F		0000-7F7F
10	00-07	47	2	0000-7F7F	Effect 1 Parameter 7 MSB/LSB	0000-7F7F		0000-7F7F		0000-7F7F
10	00-07	48	2	0000-7F7F	Effect 1 Parameter 8 MSB/LSB	0000-7F7F		0000-7F7F		0000-7F7F
10	00-07	49	2	0000-7F7F	Effect 1 Parameter 9 MSB/LSB	0000-7F7F		0000-7F7F		0000-7F7F
10	00-07	4A	2	0000-7F7F	Effect 1 Parameter 10 MSB/LSB	0000-7F7F		0000-7F7F		0000-7F7F
10	00-07	4B	2	0000-7F7F	Effect 1 Parameter 11	0000-7F7F		0000-7F7F		0000-7F7F
10	00-07	4C	2	0000-7F7F	Effect 1 Parameter 12	0000-7F7F		0000-7F7F		0000-7F7F
10	00-07	4D	2	0000-7F7F	Effect 1 Parameter 13	0000-7F7F		0000-7F7F		0000-7F7F
10	00-07	4E	2	0000-7F7F	Effect 1 Parameter 14	0000-7F7F		0000-7F7F		0000-7F7F
10	00-07	4F	2	0000-7F7F	Effect 1 Parameter 15	0000-7F7F		0000-7F7F		0000-7F7F
10	00-07	50	2	0000-7F7F	Effect 1 Parameter 16	0000-7F7F		0000-7F7F		0000-7F7F
10	00-07	51	3	00 00-7F 00-7F	Effect 2 Type MSB/LSB	00 00-7F 00-7F	○	00 00-7F 00-7F	○	00 00-7F 00-7F
10	00-07	52	2	0000-7F7F	Effect 2 Parameter 1 MSB/LSB	0000-7F7F	○	0000-7F7F	○	0000-7F7F
10	00-07	53	2	0000-7F7F	Effect 2 Parameter 2 MSB/LSB	0000-7F7F		0000-7F7F		0000-7F7F
10	00-07	54	2	0000-7F7F	Effect 2 Parameter 3 MSB/LSB	0000-7F7F		0000-7F7F		0000-7F7F
10	00-07	55	2	0000-7F7F	Effect 2 Parameter 4 MSB/LSB	0000-7F7F		0000-7F7F		0000-7F7F
10	00-07	56	2	0000-7F7F	Effect 2 Parameter 5 MSB/LSB	0000-7F7F		0000-7F7F		0000-7F7F
10	00-07	57	2	0000-7F7F	Effect 2 Parameter 6 MSB/LSB	0000-7F7F		0000-7F7F		0000-7F7F
10	00-07	58	2	0000-7F7F	Effect 2 Parameter 7 MSB/LSB	0000-7F7F		0000-7F7F		0000-7F7F
10	00-07	59	2	0000-7F7F	Effect 2 Parameter 8 MSB/LSB	0000-7F7F		0000-7F7F		0000-7F7F
10	00-07	5A	2	0000-7F7F	Effect 2 Parameter 9 MSB/LSB	0000-7F7F		0000-7F7F		0000-7F7F
10	00-07	5B	2	0000-7F7F	Effect 2 Parameter 10 MSB/LSB	0000-7F7F		0000-7F7F		0000-7F7F
10	00-07	5C	2	0000-7F7F	Effect 2 Parameter 11	0000-7F7F		0000-7F7F		0000-7F7F
10	00-07	5D	2	0000-7F7F	Effect 2 Parameter 12	0000-7F7F		0000-7F7F		0000-7F7F
10	00-07	5E	2	0000-7F7F	Effect 2 Parameter 13	0000-7F7F		0000-7F7F		0000-7F7F
10	00-07	5F	2	0000-7F7F	Effect 2 Parameter 14	0000-7F7F		0000-7F7F		0000-7F7F
10	00-07	60	2	0000-7F7F	Effect 2 Parameter 15	0000-7F7F		0000-7F7F		0000-7F7F
10	00-07	61	2	0000-7F7F	Effect 2 Parameter 16	0000-7F7F		0000-7F7F		0000-7F7F
10	00-07	62	1		Sustain (On/Off)	00:OFF 01:ON	○	00-7F	○	00-7F
10	00-07	63	1		Length	7F:Hold 7E:Long 00:Short	○	00-7F	○	00-7F

Organ Flute Voice Parameters (Address mm: 0 – 1 = UK, LK)

Address			Size	Data	Parameter	Data	Receive	Rx Range	Transmit	Tx Range
hh	mm	ll								
11	00-01	00	1	00-7F	Footage 16'	00:MIN 7F:MAX	○	00-7F	○	00-7F
11	00-01	01	1	00-7F	Footage 8'	00:MIN 7F:MAX	○	00-7F	○	00-7F
11	00-01	02	1	00-7F	Footage 5-1/3'	00:MIN 7F:MAX	○	00-7F	○	00-7F
11	00-01	03	1	00-7F	Footage 4'	00:MIN 7F:MAX	○	00-7F	○	00-7F
11	00-01	04	1	00-7F	Footage 2-2/3'	00:MIN 7F:MAX	○	00-7F	○	00-7F

Address			Size	Data	Parameter	Data	Receive	Rx Range	Transmit	Tx Range
hh	mm	ll								
11	00-01	05	1	00-7F	Footage 2'	00:MIN 7F:MAX	○	00-7F	○	00-7F
11	00-01	06	1	00-7F	Footage 1-3/5'	00:MIN 7F:MAX	○	00-7F	○	00-7F
11	00-01	07	1	00-7F	Footage 1-1/3'	00:MIN 7F:MAX	○	00-7F	○	00-7F
11	00-01	08	1	00-7F	Footage 1'	00:MIN 7F:MAX	○	00-7F	○	00-7F
11	00-01	09	1	00-7F	Response	00:FAST 7F:SLOW	○	00-7F	○	00-7F
11	00-01	0A	1	00-7F	Attack 4'	00:MIN 7F:MAX	○	00-7F	○	00-7F
11	00-01	0B	1	00-7F	Attack 2-2/3'	00:MIN 7F:MAX	○	00-7F	○	00-7F
11	00-01	0C	1	00-7F	Attack 2'	00:MIN 7F:MAX	○	00-7F	○	00-7F
11	00-01	0D	1	00-7F	Attack Length	00:Short 7F:Long	○	00-7F	○	00-7F
11	00-01	10	1	00-7F	Organ Flutes (On/Off)	00:OFF 01:ON	○	00-7F	×	-
11	00-01	11	1	00-7F	Volume	00:MIN 7F:MAX	○	00-7F	○	00-7F
11	00-01	12	1	00-7F	Reverb (Send Level)	00:MIN 7F:MAX	○	00-7F	○	00-7F
11	00-01	13	1	00-7F	Type (Sine/Vintage)	00:Sine 01:Vintage	○	00-7F	○	00-01
11	00-01	40	3	00 00-7F 00-7F	Effect Type MSB/LSB	00 00-7F 00-7F	○	00 00-7F 00-7F	○	00 00-7F 00-7F
11	00-01	41	2	0000-7F7F	Effect1 Parameter1 MSB/LSB <small>1st:ParameterMSB 2nd:ParameterLSB</small>		○	0000-7F7F	○	0000-7F7F
11	00-01	42	2	0000-7F7F	Effect1 Parameter2 MSB/LSB		○	0000-7F7F	○	0000-7F7F
11	00-01	43	2	0000-7F7F	Effect1 Parameter3 MSB/LSB		○	0000-7F7F	○	0000-7F7F
11	00-01	44	2	0000-7F7F	Effect1 Parameter4 MSB/LSB		○	0000-7F7F	○	0000-7F7F
11	00-01	45	2	0000-7F7F	Effect1 Parameter5 MSB/LSB		○	0000-7F7F	○	0000-7F7F
11	00-01	46	2	0000-7F7F	Effect1 Parameter6 MSB/LSB		○	0000-7F7F	○	0000-7F7F
11	00-01	47	2	0000-7F7F	Effect1 Parameter7 MSB/LSB		○	0000-7F7F	○	0000-7F7F
11	00-01	48	2	0000-7F7F	Effect1 Parameter8 MSB/LSB		○	0000-7F7F	○	0000-7F7F
11	00-01	49	2	0000-7F7F	Effect1 Parameter9 MSB/LSB		○	0000-7F7F	○	0000-7F7F
11	00-01	4A	2	0000-7F7F	Effect1 Parameter10 MSB/LSB		○	0000-7F7F	○	0000-7F7F
11	00-01	4B	2	0000-7F7F	Effect1 Parameter11		○	0000-7F7F	○	0000-7F7F
11	00-01	4C	2	0000-7F7F	Effect1 Parameter12		○	0000-7F7F	○	0000-7F7F
11	00-01	4D	2	0000-7F7F	Effect1 Parameter13		○	0000-7F7F	○	0000-7F7F
11	00-01	4E	2	0000-7F7F	Effect1 Parameter14		○	0000-7F7F	○	0000-7F7F
11	00-01	4F	2	0000-7F7F	Effect1 Parameter15		○	0000-7F7F	○	0000-7F7F
11	00-01	50	2	0000-7F7F	Effect1 Parameter16		○	0000-7F7F	○	0000-7F7F
11	00-01	62	1	00-7F	Sustain (On/Off)	00:OFF 01:ON	○	00-7F	○	00-01
11	00-01	63	1	00-7F	Length	7F:Hold 7E:Long 00:Short	○	00-7F	○	15-3D,7F

Keyboard Parameters

Sustain Parameters (Address mm: 0 – 2 = UK, LK, PEDAL)

Address			Size	Data	Parameter	Data	Receive	Rx Range	Transmit	Tx Range
hh	mm	ll								
12	00-02	00	1	00-7F	Sustain (On/Off)	00:OFF 01:ON	○	00-7F	×	-
12	00-02	01	1	00-7F	Length	00:Short 7F:Long	○	00-7F	×	15-3D

Keyboard Percussion Parameters (Address mm: 1 – 2 = K.B.P. [1], K.B.P. [2])

Address			Size	Data	Parameter	Data	Receive	Rx Range	Transmit	Tx Range
hh	mm	ll								
12	01-02	10	1	00-7F	Keyboard Percussion (On/Off)	00:OFF 01:ON	○	00-7F	×	-
12	01-02	11	1	00-08	Keyboard Percussion Menu	00:PRESET 01:USER 1 02:USER 2 03:USER 3 04:USER 4 05:USER 5 06:USER 6 07:USER 7 08:USER 8	○	00-08	○	00-08

Rhythm

Rhythm Parameters

Address			Size	Data	Parameter	Data	Receive	Rx Range	Transmit	Tx Range
hh	mm	ll								
13	00	00-0B	2	0000-7F7F	Rhythm Assign Number	0000-7F7F	○	00-7F 00-7F	○	00-7F 00-7F
13	00	10	1	00-0B	Rhythm Selector Number	00-0B	○	00-0B	○	00-0B
13	00	11	1	00-7F	Percussion Volume	00:MIN 7F:MAX	○	00-7F	×	-
13	00	12	1	00-7F	Percussion Reverb (Send Level)	00:MIN 7F:MAX	○	00-7F	○	00-7F
13	00	13	1	00-7F	2nd Expression Tempo Control (On/Off)	00:OFF 01:ON	○	00-7F	○	00-01
13	00	14	1	00-7F	Footswitch Rhythm Control	00:INTRO 1 01:INTRO 2 02:INTRO 3 08:MAIN A 09:MAIN B 0A:MAIN C 0B:MAIN D 18:BREAK 20:ENDING 1 21:ENDING 2 22:ENDING 3 7E:STOP 7F:OFF (INTRO 1 – STOP)	○	00-7F	○	00-7F
13	00	15	1	00-7F	Add Drum (On/Off)	00:OFF 01:ON	○	00-7F	○	00-01
13	00	16	1	00-7F	Main Drum (On/Off)	00:OFF 01:ON	○	00-7F	○	00-01
13	00	17	1	00-7F	Chord 1 (On/Off)	00:OFF 01:ON	○	00-7F	○	00-01
13	00	18	1	00-7F	Chord 2 (On/Off)	00:OFF 01:ON	○	00-7F	○	00-01
13	00	19	1	00-7F	Pad (On/Off)	00:OFF 01:ON	○	00-7F	○	00-01
13	00	1A	1	00-7F	Phrase 1 (On/Off)	00:OFF 01:ON	○	00-7F	○	00-01
13	00	1B	1	00-7F	Phrase 2 (On/Off)	00:OFF 01:ON	○	00-7F	○	00-01
13	00	1C	1	00-7F	Auto Fill (On/Off)	00:OFF 01:ON	○	00-7F	○	00-01

Rhythm Sequence Parameters

Address			Size	Data	Parameter	Data	Receive	Rx Range	Transmit	Tx Range
hh	mm	ll								
13	01	00-03	1	00-7F	Sequence [SEQ.1] – [SEQ.4]	00:OFF 01:ON	○	00-7F	×	-

Accompaniment Parameters

Address			Size	Data	Parameter	Data	Receive	Rx Range	Transmit	Tx Range
hh	mm	ll								
13	02	11	1	00-7F	Accompaniment Volume	00:MIN 7F:MAX	○	00-7F	○	00-7F
13	02	12	1	00-7F	Accompaniment Reverb (Send Level)	00:MIN 7F:MAX	○	00-7F	○	00-7F

A.B.C. Function Parameters

Address			Size	Data	Parameter	Data	Receive	Rx Range	Transmit	Tx Range
hh	mm	ll								
13	03	00	1	00-7F	Auto Bass Chord Mode	00:OFF 01:Single Finger 02:Fingered 03:Custom A.B.C.	○	00-7F	○	00-03
13	03	01	1	00-7F	Lower Memory (On/Off)	00:OFF 01:ON	○	00-7F	○	00-01
13	03	02	1	00-7F	Pedal Memory (On/Off)	00:OFF 01:ON	○	00-7F	○	00-01

M.O.C. Function Parameters

Address			Size	Data	Parameter	Data	Receive	Rx Range	Transmit	Tx Range
hh	mm	ll								
13	04	00	1	00-7F	Melody On Chord Mode	00:OFF 01:1 02:2 03:3	○	00-7F	○	00-03
13	04	01	1	00-7F	M.O.C. Foot Pedal Control (On/Off)	00:OFF 01:ON	○	00-7F	○	00-01

Section Parameters

Address			Size	Data	Parameter	Data	Receive	Rx Range	Transmit	Tx Range
hh	mm	ll								
13	05	00	1	00-7F	Intro 1 (On/Off)	00:OFF 01:ON	○	00-7F	○	00-01
13	05	01	1	00-7F	Intro 2 (On/Off)	00:OFF 01:ON	○	00-7F	○	00-01
13	05	02	1	00-7F	Intro 3 (On/Off)	00:OFF 01:ON	○	00-7F	○	00-01
13	05	08	1	00-7F	Main A (On/Off)	00:OFF 01:ON	○	00-7F	○	00-01
13	05	09	1	00-7F	Main B (On/Off)	00:OFF 01:ON	○	00-7F	○	00-01
13	05	0A	1	00-7F	Main C (On/Off)	00:OFF 01:ON	○	00-7F	○	00-01
13	05	0B	1	00-7F	Main D (On/Off)	00:OFF 01:ON	○	00-7F	○	00-01
13	05	18	1	00-7F	Break (On/Off)	00:OFF 01:ON	○	00-7F	○	00-01
13	05	20	1	00-7F	Ending 1 (On/Off)	00:OFF 01:ON	○	00-7F	○	00-01
13	05	21	1	00-7F	Ending 2 (On/Off)	00:OFF 01:ON	○	00-7F	○	00-01
13	05	22	1	00-7F	Ending 3 (On/Off)	00:OFF 01:ON	○	00-7F	○	00-01

Keyboard Percussion Parameters

Address			Size	Data	Parameter	Data	Receive	Rx Range	Transmit	Tx Range
hh	mm	ll								
13	10	11	1	00-7F	Volume	00:MIN 7F:MAX	○	00-7F	○	00-7F
13	10	12	1	00-7F	Reverb (Send Level)	00:MIN 7F:MAX	○	00-7F	○	00-7F

Overall

System Parameters

Address			Size	Data	Parameter	Data	Receive	Rx Range	Transmit	Tx Range
hh	mm	ll								
14	00	00	1	00-7F	Disable (On/Off)	00:OFF 01:ON	○	00-7F	×	-
14	00	01	1	00-7F	Organ Flute Attack Mode	00:Each 01:First	○	00-7F	○	00-01
14	00	02	1	3A-46	Transpose	3A:KeyDown 40:Normal 46:KeyUp	○	3A-46	○	3A-46
14	00	03	1	01-0C	2nd Expression Range	01:100 C 0C:1200 C	○	01-0C	○	01-0C
14	00	04	1	00-7F	Footswitch Mode	00:OFF 01:Rhythm 02:Glide 03:Rotary Speaker	○	00-7F	○	00-03
14	00	05	1	00-7F	Pitch	00:PitchDown 40:Normal 7F:PitchUp	○	00-7F	○	00-7F
14	00	06	1	00-7F	Footswitch Glide Time	00:FAST 7F:SLOW	○	00-7F	○	04-1C
14	00	08	1	00-7F	MIDI Control Expression (INT/EXT)	00:Internal 01:External	○	00-7F	×	-
14	00	09	1	00-7F	MIDI Control Lead 1 (INT/EXT)	00:Internal 01:External	○	00-7F	×	-
14	00	0A	3	00-04, 06 00-03 00-0B	Registration Menu	00-04, 06 00-03 00-0B	○	00-04, 06 00-03 00-0B	○	00-04, 06 00-03 00-0B

Effect Parameters (Overall): Reverb

Address			Size	Data	Parameter	Data	Receive	Rx Range	Transmit	Tx Range
hh	mm	ll								
14	01	00	1	00-7F	Reverb Depth	00:MIN 7F:MAX	○	00-7F	×	-
14	01	01	1	00-7F	Reverb Time (Panel)	00:FAST 7F:SLOW	○	00-7F	○	00-45
14	01	02	3	00 00-7F 00-7F	Reverb Type (Panel)	00 00-7F 00-7F	○	00 00-7F 00-7F	○	00 00-7F 00-7F

Effect Parameters (Overall): Rhythm Reverb

Address			Size	Data	Parameter	Data	Receive	Rx Range	Transmit	Tx Range
hh	mm	ll								
14	02	01	1	00-7F	Reverb Time (Rhythm)	00:FAST 7F:SLOW	○	00-7F	○	00-45
14	02	02	3	00 00-7F 00-7F	Reverb Type (Rhythm)	00 00-7F 00-7F	○	00 00-7F 00-7F	○	00 00-7F 00-7F

Effect Parameters (Overall): Rotary Speaker

Address			Size	Data	Parameter	Data	Receive	Rx Range	Transmit	Tx Range
hh	mm	ll								
14	03	00	1	00-7F	Rotary Speaker Speed (On/Off)	00:OFF 01:ON	○	00-7F	×	-
14	03	01	1	00-7F	Rotary Speaker Speed Control Mode	00:STOP 01:SLOW	○	00-7F	○	00-01
14	03	02	2	0000-007F	Rotary Speaker Speed Control Speed	0000:SLOW 007F:FAST	○	0000-007F	○	0040-007F

AUX OUT

Address			Size	Data	Parameter	Data	Receive	Rx Range	Transmit	Tx Range
hh	mm	ll								
14	04	00-13	1	00-03	AUX OUT Address II: 00-07 = UK1, UK2, LK1, LK2, Lead1, Lead2, PEDAL1, PEDAL2 08 = Upper Organ Flutes, 09 = Lower Organ Flutes, 0A = Main Drum, 0B = Add Drum, 0C = Accompaniment, 11 = KBP, 12 = MIC, 13 = XG	00:MAIN 01:SUB1 02:SUB2 03:SUB1&2	○	00,04-7F 01 02 03	○	00 01 02 03

Foot Pedal

Address			Size	Data	Parameter	Data	Receive	Rx Range	Transmit	Tx Range
hh	mm	ll								
14	05	00	1	00-09	Foot Pedal 1 Assign	00:OFF 01:Expression 02:Sustain 03:Slide 04:MOC 05:Solo 06:Rhythm Control 07:Glide 08:Rotary Speaker 09:Regist Shift	○	00,0A-7F 01 02 03 04 05 06 07 08 09	○	00 01 02 03 04 05 06 07 08 09
14	05	01	1	00-01	Foot Pedal 1 Polarity	00:- 01:+	○	00 01	○	00 01
14	05	02	1	00-7F	Foot Pedal 1 Data (ON/OFF)		○	00-7F	○	00-7F
14	05	10	1	00-09	Foot Pedal 2 Assign	00:OFF 01:Expression 02:Sustain 03:Slide 04:MOC 05:Solo 06:Rhythm Control 07:Glide 08:Rotary Speaker 09:Regist Shift	○	00,0A-7F 01 02 03 04 05 06 07 08 09	○	00 01 02 03 04 05 06 07 08 09
14	05	11	1	00-01	Foot Pedal 2 Polarity	00:- 01:+	○	00 01	○	00 01
14	05	12	1	00-7F	Foot Pedal 2 Data (ON/OFF)		○	00-7F	○	00-7F

*4. MDR

nn	Command	Receive	Transmit
01H	Play Start	○	×
02H	Play Stop	○	×
03H	Record Start	○	×
04H	Record Stop	○	×
05H	Fast Forward Start	○	×
06H	Fast Forward Stop	○	×
09H	Rhythm Pointer Reset	○	×

MIDI Implementation Chart

YAMAHA DDK / Model: DDK-7

Date: 6-Apr-2006
Version: 1.00

Function		Transmitted	Recognized	Remarks
Basic Channel	Default Changed	1, 2, 3, 16 (*1) 1-16	1-3, 5-16 (*2) 4	
Mode	Default Messages Altered	Mode 3 × *****	Mode 3 × ×	
Note Number	:True Voice	36-96 (*3) *****	0-127 (*4)	
Velocity	Note on Note off	○ 9nH, v=1-127 × 9nH, v=0	○ 9nH, v=1-127 × 9nH, v=0 or 8nH	
After Touch	Key's Ch's	× ○	○ (*6) ○	
Pitch Bend		○ (*5)	○	
Control Change		0, 32 × 1, 5, 7, 10 × 4 ○ (*7) 6, 38 × 11 ○ (*7) 16 × 64 ○ (*7) 65-67 × 71-78 × 84, 91, 93, 94 × 96, 97 × 98-99, 100-101 ×	○ (*6) ○ (*6) ○ (*7) ○ (*6) ○ (*6, 7) × ○ (*6, 7) ○ (*6) ○ (*6) ○ (*6) ○ (*6) ○ (*6)	Bank Select 2nd Expression Data Entry Expression VA After Touch Sustain Sound Controller Data Entry SW NRPN, RPN
Program Change	:True number	○ (*10) *****	○ (*11)	
System Exclusive		○	○	
System Common	:Song Position :Song Select :Tune	× × ×	× × ×	
System Real Time	:Clock :Commands	○ ○	○ (*9) ○	(FAH, FCH)
Aux Messages	:All Sound Off :Reset All Cntrls :Local On/Off :All Notes Off :Active Sense :Reset	× × × × ○ ×	○ (120) (*6) ○ (121) (*6) × ○ (123-127) (*6) ○ ×	
Notes		*1: 1ch: UK, 2ch: LK, 3ch: PEDAL, 16ch: CONTROL *2: 1ch: UK, 2ch: LK, 3ch: PEDAL, 4ch: LEAD1, 5-14ch: XG, 15ch: KEYBOARD PERCUSSION, 16ch: CONTROL *3: UK: 48-96, LK: 36-96, PEDAL: 36-60 *4: UK, LK, PEDAL, LEAD1: 36-96, XG: 0-127, PERCUSSION: 3-127 *5: UK: UK HorizontalTouch, LK: LK HorizontalTouch *6: XG only *7: CONTROL only *8: UK only *9: External Mode only *10: CONTROL: 0-15 *11: UK, LK, PEDAL, CONTROL: 0-15 XG: 0-127		

Mode 1 : OMNI ON, POLY
Mode 3 : OMNI OFF, POLY

Mode 2 : OMNI ON, MONO
Mode 4 : OMNI OFF, MONO

○ : Yes
× : No

Function		Transmitted (*1)	Recognized	Remarks
Basic Channel	Default Changed	1, 2, 3, 16 1-16	1-16 1-16	
Mode	Default Messages Altered	Mode3 X *****	Mode 3 X X	
Note Number	:True Voice	36-96 *****	0-127	
Velocity	Note on Note off	○ 9nH, v=1-127 X 9nH, v=0	○ 9nH, v=1-127 X 9nH, v=0 or 8nH	
After Touch	Key's Ch's	X ○	○ ○	
Pitch Bend		○	○	
Control Change		0, 32 X 1, 5, 7, 10 X 4 ○ 6, 38 X 11 ○ 16 X 64 ○ 65-67 X 71-78 X 84, 91, 93, 94 X 96, 97 X 98-99, 100-101 X	○ ○ X ○ ○ X ○ ○ ○ ○ ○ ○ ○	Bank Select 2nd Expression Data Entry Expression VA After Touch Sustain Sound Controller Data Entry SW NRPN, RPN
Program Change	:True number	○ 0-15 *****	○	
System Exclusive		○	○	
System Common	:Song Position :Song Select :Tune	X X X	X X X	
System Real Time	:Clock :Commands	○ ○	X X	
Aux Messages	:All Sound Off :Reset All Cntrls :Local On/Off :All Notes Off :Active Sense :Reset	X X X X ○ X	○ (120) ○ (121) X ○ (123-127) ○ X	
Notes		*1: Same as that in the EL mode		

Mode 1 : OMNI ON, POLY
Mode 3 : OMNI OFF, POLY

Mode 2 : OMNI ON, MONO
Mode 4 : OMNI OFF, MONO

○ : Yes
X : No

Troubleshooting

Problem	Possible Cause and Solution
GENERAL OPERATION	
The sound is not heard for about 10 seconds after turning the power on.	This is normal; the DDK-7 takes a while to start up.
A cracking noise is sometimes heard.	Noise may be produced when either an electrical appliance is turned on or an electric power tool (such as drill) is used in the proximity of the DDK-7. If this occurs, plug the DDK-7 into an electrical outlet located as far as possible from the device that seems to be the source of the problem.
Interference from radio, TV, or other sources occurs.	This is caused by the proximity of a high-power broadcasting station, an amateur ham radio setup or a mobile phone.
The sound of the DDK-7 causes surrounding objects to resonate.	Because the DDK-7 is capable of producing powerful bass sounds, resonance may be caused in surrounding objects, such as cabinets or glass windows. To avoid this, relocate the objects or lower the DDK-7's volume.
In the LCD display, there are some black points (unlit) or white points (always lit).	Unfortunately, this is a common characteristic of TFT-LCDs.
The sound is too small even when the volume is set to its maximum.	<ul style="list-style-type: none"> • The Master Volume may be set around the minimum position. Turn it clockwise. • The Expression Pedal or Foot Pedal may not be pressed down. Press it down with your toe.
Foot Pedals has no effect.	"OFF" is selected in the Foot Pedal display. Select function to assign it to the Foot Pedal. (page 196)
The DDK-7 panel does not function normally or the content of the memorized data has changed.	This happens very rarely. Occasionally, power surges and spikes due to electrical storms or other reasons may cause the DDK-7 to malfunction and/or alter the contents of memorized data. If this happens, perform the Factory Set operation to reset the DDK-7 (page 23).
The Pedal Unit does not work.	A cable of the Pedal Unit is disconnected. Make sure that power is OFF when connecting or disconnecting the pedal.
Some parts cannot be heard from the Headphones or an external speakers.	The parts are assigned to AUX OUT SUB jacks. If you want to hear all parts from Headphones, select AUX OUT MAIN jacks for all parts. (page 228) If you want to hear all parts from an external speakers, use the output from the mixer.

Problem	Possible Cause and Solution
VOICES/RHYTHMS	
The pitch may sound excessively high on the Pedalboard and low in the higher registers of the Lower and Upper keyboards.	This may occur when you compare the DDK-7's sounds with that of a piano. Because of the difference of the harmonics structure, the tuning system of the DDK-7 is different from the piano in the higher and lower ranges.
Some of the Voices may contain cracking and/or noisy sounds.	You may find these mainly in the wind instrument Voices. These are purposely added effects to the Voices to reproduce the characteristics of the wind instruments such as the pipe vibrations, breath noises and squeaks.
When too many keys are pressed, not all of the notes sound.	Total polyphonic capacity (notes sounding for both Upper and Lower Keyboards) is 14 notes. When you turn the Pedal Polyphonic mode to on, the total is 14 for all keyboards, Upper, Lower and Pedalboard.
Only one sound is heard when two notes of the Lead or Pedal Voices are simultaneously played.	For practical performance reasons, the DDK-7 has been designed so that only one note of the Lead or Pedal Voices can be played at a time. If you want, the pedal Voice can be set to polyphonic mode (page 42).
The Pedal Voices do not sound, even though the volume is properly set.	<ul style="list-style-type: none"> • The Single Finger or Fingered Chord mode of Auto Bass Chord is on. Turn off the mode in the display (page 71). • TO LOWER buttons in the Pedal Voice sections are turned on. Turn the function off (page 29).
When selecting a Voice or rhythm, the Voice or rhythm title at the top of the LCD does not match the selected Voice or rhythm.	The currently assigned Voice or rhythm is displayed at the top of the LCD, and remains until another Voice or rhythm has been selected.
When keys are pressed, the sounds of percussion instruments are also heard.	The Keyboard Percussion function has been turned on. When not using the function, be sure to turn it off (page 74).
Even though a User button's rhythm has been selected and started, the pattern does not sound.	Since the User buttons contain User rhythms, no rhythm will sound if a pattern has not been saved to the selected User button.
EFFECTS	
The Touch Tone function does not operate.	Adjust the Touch Tone settings in the Voice Condition display (page 41).
The Reverb effect is not applied to the desired Voice sections, even when the total Reverb depth on the panel is increased.	Increase the Reverb depth for the desired Voice sections in Reverb Display Pages 2 – 3.
The Rotary Speaker effect cannot be heard, even when the [ROTARY SP SPEED] button in the DISPLAY SELECT section is on.	Rotary Speaker must be selected first in Voice Condition display Pages 3 and/ or 4 (for panel Voices), or in the Organ Flute Voices ATTACK/VOLUME Page (for Organ Flute Voices).
ACCOMPANIMENT	
The pitch in the Single Finger mode does not change, even when pressing different keys of the keyboard.	Single Finger mode will only produce notes when played within a fixed octave interval on the Lower keyboard. If notes with the same letter name are pressed outside of that range, the chords that are sounded will share the same pitch.
While an Intro/Ending pattern is automatically playing, the Lower keyboard does not produce any sound, even when the keys are played.	Since the Accompaniment chords play automatically one after another, the Lower keyboard is designed not to produce any sound during the playback of an Intro/Ending pattern.
The Accompaniment cannot be heard even when an appropriate Accompaniment type is selected and the rhythm has been started.	<ul style="list-style-type: none"> • The Accompaniment volume may have been set to 0. Be sure to raise the Accompaniment volume in the Rhythm Condition display (page 71). • All Accompaniment parts may be set to off (mute). Set the desired part on (page 70).
The harmony notes of the Melody On Chord function cannot be heard.	The Upper keyboard has been set to sound only Lead Voices. Increase the volume of the Upper Keyboard Voices.
The bass phrase of the Auto Bass Cord cannot be heard.	The pedal polyphonic mode may be set to on. Turn it off in the Voice Condition display (page 42).
REGISTRATION MEMORY	
Certain functions have not been memorized to Registration Memory.	Some functions cannot be memorized. Refer to page 90.

Problem	Possible Cause and Solution
VOICE EDITING	
During Voice editing, the specified Voice isn't heard, even when the keyboard is played.	<ul style="list-style-type: none"> The Element is turned to mute or its level is set to minimum. Turn it to on or increase the volume. You may have played keys outside the range of Note Limit. Play only keys within the Note Limit range.
An error message appears while the Voice name is entered.	Voice name capacity is 16 characters. Delete the unnecessary letters or spaces.
RHYTHM PROGRAM	
During use of the Rhythm Pattern Program, no sound is produced even when you play a certain percussion sound.	If percussion sounds have been recorded while memory is full, no subsequently selected instruments can be heard or recorded. If necessary, erase some of the less necessary percussion sounds and play again.
MUSIC DATA RECORDER	
Recording or playback cannot be performed.	<ul style="list-style-type: none"> The part buttons in the Rec Standby display or Playing display may have been turned off. Turn the desired part to REC or PLAY. The performance data is too large. The maximum limit for recording performance data is 1 MB. The media is write-protected. Cancel the write-protect. The media/folder may contain EL-format songs. You cannot record to the media/folder that contains EL-format songs. Create a new folder and record the song to it.
Recording is stopped before the performance is finished.	<ul style="list-style-type: none"> The amount of recorded data on the media is close to the maximum limit. Either use another media or delete the data of unnecessary songs. When you overwrite the song, the length of a subsequently recorded part cannot exceed the length of the previously recorded parts. Delete the previously recorded song, then record again (page 129). The performance data is too large. The maximum limit for recording performance data is 1 MB.
An error message appears while entering a folder name or song name.	<ul style="list-style-type: none"> The song/folder name is too long. The capacity is 50 letters. The song/folder name may be an invalid name. Refer to page 115. The path name is too long. The capacity of the path name is 234 letters. Reduce the layer or shorten the song/folder name to shorten the path.
The rhythm does not start at the beginning of a recording, or stops in the middle of the performance.	The M.D.R. is designed so that the rhythm cannot be started at the very beginning of a recording. If you wish to use the rhythm, start it after the time indicator appears in the display.
The floppy disk cannot be formatted when you want to format an unformatted disk.	Recognizing an unformatted disk takes a few seconds after it is inserted. Wait about 30 seconds, then try to format again.
The notes of the recording are "stuck" and sound continuously.	During playback, you may have removed the USB flash memory or floppy disk. Whenever you wish to stop playback, always press the [■] (Stop) button before removing the media.

Specifications

KEYBOARD	Keyboard Type	UPPER: 49 Keys (C-C) Standard (FS) LOWER: 61Keys (C-C) Standard (FS)	
	Touch Tone	UPPER: Initial Touch/After Touch LOWER: Initial Touch/After Touch	
TONE GENERATION		AWM2	
	Maximum Polyphony	Voice Sections: 128 notes Organ/Rhythm Sections, XG: 128 notes	
	Multi Timbral Capacity	16	
	Wave	Voice Sections: 177MB (when converted to 16-bit linear format) Organ/Rhythm Sections, XG: 166MB (when converted to 16-bit linear format)	
Registration	Memory	1-16, D. (Disable)	
	Basic Registration	1-16, Current Registration	
	Registration Menu	288 Registrations	
Voice	Preset Voice	Preset: 415 Voices + 25 Drum Kits XG(Only for playing): 480 Voices + 11 Drum Kits User Voice: 16	
	Voice Sections	UPPER: 2, LEAD: 2, LOWER: 2, PEDAL: 2	
	Voice Buttons	SECTION SELECT, VOLUME UP/DOWN, TO LOWER (LEAD1, PEDAL1,2), SOLO (LEAD2)	
Effects		Reverb: 29 Types x 2 (Voice/Rhythm), Brilliance, Sustain, Insertion(1, 2)x 183 Types x 8	
Organ Flute Voice	Organ Sections	UPPER, LOWER	
	Type	SINE, VINTAGE	
	Footage	16', 5 1/3', 8', 4', 2 2/3', 2', 1 3/5', 1 1/3', 1', Attack: 4', 2 2/3', 2', LENGTH, RESPONSE	
	Mode	FIRST, EACH	
	Organ Effect	15 Type	
	Control	U.ORGAN FLUTES, L.ORGAN FLUTES, ROTARY SP SPEED	
Rhythm	Rhythm	Preset: 274 Pattern x 7 parts x 15 Sections User Rhythm: 48 Pattern x 7 parts x 15 Sections	
	Rhythm Buttons	SECTION SELECT, VOLUME UP/DOWN	
	Parts	Main Drum, Add Drum, Chord 1, Chord 2, Pad, Phrase1, Phrase 2	
	Rhythm Control	INTRO 1,2,3, ENDING 1,2,3, MAIN A,B,C,D, FILL IN A,B,C,D, BREAK	
	Tempo	40 - 240	
	Keyboard Percussion	Preset: 2, User: 8	
Subordinate Performance	Auto Bass Chord	3 Type, Memory (LOWER, PEDAL)	
	Melody On Chord	3 Type, Memory (LOWER, PEDAL)	
PROGRAMS	Voice Edit	Layers	AWM (4)
		Parameter	Element ON/OFF, EQ Low Frequency, EQ Low Gain, EQ High Frequency, EQ High Gain, Level, Note Limit, Pan, Note Shift, Tune Fine, Attack Rate, Release Rate, Cutoff Frequency, Resonance, LFO waveform, LFO Speed, LFO Pitch Modulation Depth, LFO Frequency Modulation Depth, LFO Amplitude Modulation Depth
Rhythm Pattern Program	Sections	INTRO 1, 2, 3, ENDING 1, 2, 3, MAIN A, B, C, D, FILL IN A, B, C, D, BREAK	
	Note Resolution	480 ppq (parts per quarter note)	
	Beat	2/4, 3/4, 4/4, 5/4	
	Measure	32	
	Kits	20 Drum Kits + 5 SFX Kits	
	Accompaniment	Chord1, 2	
	Voice	480 Voices	
	Effects	Reverb: 29 Types, Chorus:15 Types, Variations: 183 Type	
	Percussion Instrument Setting	Pan, Volume, Reverb, Pitch Coarse/Fine	

	Rhythm Sequence Program	Sequence	140 measures x 4 Sequences
	Registration Sequence Program	Sequence	140 Registration x 4Sequence, Next Registration
		Set Resolution	96 ppq (parts per quarter note)
	Keyboard Percussion Assign	Kits	16 Drum Kits
		Drum Setup	Pan, Volume, Reverb, Pitch Coarse/Fine
	Registration Shift	Steps	80 Steps
		Shift End	Stop, Top, Next Regist
	Unifying parameter	Parameters	Reverb (Voice/Rhythm), Volume, Pan, Brilliance, Sustain
M. D. R.		Folder	Up to 100 folders can exist in one media.
		Song	Up to 100 songs can exist in one folder.
		Registration	Up to 50 Registrations can exist in one song.
		Recording	UPPER, LOWER, PEDAL, CONTROL, LEAD, K.B.P.
	Playing	UPPER, LOWER, PEDAL, CONTROL, LEAD, K.B.P., XG	
	Sequence Format	DDK Original format (Copy Protect), SMF format 0, 1 (Format 1 load only)	
	Format Conversion	Convert TO EL, Convert FROM EL, Convert to XG	
CONTROLS	Display Control		VOICE DISPLAY, REGIST MENU, FOOT SWITCH, MDR, INTERNET, UTILITY, PROGRAM, SUSTAIN, REVERB
	Foot Pedal	Section	1 (Expression), 2 (Sustain)
		Select	Expression, Sustain, Rhythm, Glide, Rotary speaker, Slide, M.O.C.
	FootSwitch (When DDKU-P7 is used)	Left	Rhythm, Glide, Rotary speaker
Right		Shift, Jump, User	
OTHERS	LCD Display	Size	6.5-inch 144(W) x 78.24(H)mm
		Liquid Crystal Display	TFT(WVGA) + touch panel
		Drive Method	Active Matrix
		Dots	800 x RGB x 480 dots
	Connectors		PHONES, MIC, MIC VOLUME, OUTPUT L/L+R, R(Phone), AUX OUT(LEVEL FIXED) MAIN L/L+R, R, SUB 1,2(Phone), AUX IN L/L+R, R(Phone), TO PEDAL, OPTICAL OUT, USB TO DEVICE x 2, USB TO HOST, MIDI IN/OUT, FOOT PEDAL 1(VOLUME), 2(SUSTAIN), AC INLET
	Power Consumption		51W
	Dimensions (W x D x H), Weight		1,150 (W) x 424 (D) x 173 (H) mm, 18kg
Supplied Accessories		Owner's Manual, AC Power cord	

Specifications and descriptions in this owner's manual are for information purposes only. Yamaha Corp. reserves the right to change or modify products or specifications at any time without prior notice. Since specifications, equipment or options may not be the same in every locale, please check with your Yamaha dealer.

Numerics

2nd Expression Pedal 205

A

AC INLET jack 223
 ACCENT 156
 Accompaniment 70
 Add Drum 70
 AFTER touch (Pitch) 42
 AFTER touch (Touch Tone) 41
 ASSEMBLE 153
 ASSIGN (Keyboard Percussion) 79
 ATTACK (Organ Flutes) 38
 ATTACK RATE (Voice Edit) 142
 Auto Bass Chord 71
 Auto Fill 64
 AUX IN 225
 AUX OUT (LEVEL FIXED) 225
 AWM (Voice Edit) 140

B

BAR/BEAT 66
 Bookmark 214
 BREAK 63
 Browser 211, 218

C

CHANGE SONG NAME 114
 Channel Messages 236
 CHORD 1 70
 CHORD 2 70
 CHORUS (Rhythm Pattern Program) 169
 Control Change 236
 Control Menu 211
 CONVERT FROM EL 135
 CONVERT TO EL 134
 CONVERT TO XG 132
 CUSTOM A.B.C. 72
 CUTOFF FREQ. 143

D

[D.] (Disable) 91
 DATA CONTROL dial 10
 DELAY (Vibrato) 43
 DEPTH (Reverb) 46
 DEPTH (Vibrato) 43
 Display Select 10

E

EACH (Organ Flutes) 38
 EFFECT 45
 Effect category (Voice) 45
 Effect Parameters 45
 EFFECT TYPE (Organ Flutes) 39
 Effect type (Voice) 45
 Element 137
 ENDING 63
 EQ (Equalizer) 140
 EXTERNAL 239

F

Factory Set 23
 Fast Forward 123
 FEET 42
 File 109
 FILL IN 62
 Filter 143
 FINGERED CHORD 72
 FIRST (Organ Flutes) 38
 Folder 109
 Foot Pedal 196
 FOOT PEDAL jacks 224
 FOOT SWITCH 94, 193
 FOOTAGE 37
 Footswitches 193
 FORMAT (MDR) 103

G

Gate Time 165
 Glide 195

H

Headphones 225
 Home Page 217

I

INITIAL touch 41
 Initialize (Factory Set) 23
 Initialize (Internet Settings) 221
 Initialize (Registration Memory) 93
 INTERNAL 239
 INTERNET 210
 Internet Direct Connection 209
 INTRO 62

J

Jacks and Controls 223
 JUMP 95

K	
Keyboard Percussion	74

L	
L. ORGAN FLUTES	37
LAN	219
LANGUAGE	16
LAST (Lead Voice).....	42
LAYER (Voice Edit).....	141
LCD BRIGHTNESS	17
LCD Display.....	10
LEAD 1, 2.....	8
Lead Slide.....	44
Lead Voice.....	24
LEVEL (Voice Edit).....	142
LFO (Low Frequency Oscillator).....	145
LOWER 1, 2	8
Lower Keyboard Voice	25

M	
[M.] (Memory)	89
M.O.C.....	73
MAIN	62
Main Drum	70
MAIN/FILL IN	62
MASTER VOLUME	12
MDR.....	102
Melody On Chord	73
MEMORY (A.B.C.).....	73
METRONOME.....	152
MIC jack.....	223
MIC VOLUME.....	223
MIDI	235
MIDI Control.....	238
MIDI IN/OUT	224
MIDI OUT FILTER	238
MODE (Organ Flutes).....	38
MODE (Rotary Speaker).....	51
Music Data Recorder.....	102

N	
Next Regist	118
NEXT REGIST (Shift End).....	97
NOTE LIMIT	142
NOTE SHIFT.....	142

O	
OPTICAL OUT.....	224
Organ Flutes	37
OUTPUT (MIDI).....	238

P	
PAD	70
PAN (Voice Edit).....	142
PAN (Voice).....	41
Part (Rhythm).....	70
PART SETUP (MDR).....	106, 127
Pause.....	123
PEDAL 1, 2	8
Pedal polyphonic mode	42
Pedal Unit.....	229
Pedal Voice	25
PHONES	223
PHRASE 1.....	70
PHRASE 2.....	70
Pitch.....	208
PITCH (Voice Section).....	42
Pitch Bend.....	206
Playback.....	122
POLY	42
Power.....	12
PRESET (Vibrato).....	43
Preset Keyboard Percussion.....	74
PRESET TEMPO	66
PRIORITY.....	42
PROGRAM.....	148
Program Change	236
Protected Song.....	131
Punch-in Recording.....	113

Q	
Quantize	161

R

Real Time Write	154, 162
Recording	110
Recording (Lead Voice 1 Voice only)	111
Recording (Part)	111
REGIST EDIT (MDR)	116
REGIST MENU	20
Registration Memory	89
Registration Sequence	188
Registration Shift	94
RELEASE RATE (Voice Edit)	142
Repeat	125
RESONANCE	143
RESP. (Response)	38
Reverb	46
REVERB (MIC.)	233
REVERB (Panel)	46
REVERB (Rhythm Pattern Program)	168
Rewind	123
Rhythm	60
Rhythm button	60
Rhythm Clock	156
Rhythm Condition	64
Rhythm Menu	61
Rhythm Pattern Program	148
Rhythm Program	147
Rhythm Sequence Program	183
Rhythmic Chord	163
ROTARY SP SPEED	51
Rotary Speaker	50

S

Sections	62
SHIFT (Registration Shift)	95
SHIFT END	97
SINGLE FINGER	72
SLIDE	44
SLOW (Rotary Speaker)	51
SOLO	30
Song	104, 109
Song Copy	128
Song Delete	129
Specifications	266
SPEED (Rotary Speaker)	51
SPEED (Vibrato)	43
START	63
Step Write	154
STOP (Rotary Speaker)	51
STOP (Shift End)	97
Style File Format	175
Sustain	49
SUSTAIN (Panel)	49
SYNCHRO START	63
System Exclusive Messages	236
System Messages	236

T

TEMPO (MDR)	124
TEMPO (Rhythm)	66
TIME (Slide)	44
TO LOWER	29
TOP (Lead Voice)	42
TOP (Shift End)	97
TOUCH PANEL SOUND	17
TOUCH TONE	41
TOUCH VIBRATO	44
Transpose	208
TRANPOSE (Voice section)	44
TUNE (Voice section)	44
TUNE FINE (Voice Edit)	142

U

U. ORGAN FLUTES	37
UPPER 1, 2	8
Upper Keyboard Voice	24
USB TO DEVICE	224, 234
USB TO DEVICE terminal	224
USB TO HOST	224, 230
USER (Registration Shift)	95
USER (Vibrato)	43
User Keyboard Percussion	79
User Rhythm	172
User Voice	145
UTILITY	16

V

VARIATION (Rhythm Pattern Program)	170
Version	23
VIBRATO	43
Voice	24
Voice button	26
Voice Condition	28, 41
VOICE DISPLAY	18
Voice Edit	137
Voice section	24
Volume (Accompaniment)	71
Volume (Keyboard Percussion)	75
VOLUME (MIC.)	233
VOLUME (Organ Flutes)	38
VOLUME (Rhythm Pattern Program)	167
VOLUME (Rhythm)	65
VOLUME (Voice)	28
VOLUME (XG)	127

W

Wireless LAN	219
--------------------	-----

X

XG	6, 126
----------	--------

For details of products, please contact your nearest Yamaha representative or the authorized distributor listed below.

Pour plus de détails sur les produits, veuillez-vous adresser à Yamaha ou au distributeur le plus proche de vous figurant dans la liste suivante.

Die Einzelheiten zu Produkten sind bei Ihrer unten aufgeführten Niederlassung und bei Yamaha Vertragshändlern in den jeweiligen Bestimmungsländern erhältlich.

Para detalles sobre productos, contacte su tienda Yamaha más cercana o el distribuidor autorizado que se lista debajo.

NORTH AMERICA

CANADA

Yamaha Canada Music Ltd.
135 Milner Avenue, Scarborough, Ontario,
M1S 3R1, Canada
Tel: 416-298-1311

U.S.A.

Yamaha Corporation of America
6600 Orangethorpe Ave., Buena Park, Calif. 90620,
U.S.A.
Tel: 714-522-9011

CENTRAL & SOUTH AMERICA

MEXICO

Yamaha de México S.A. de C.V.
Calz. Javier Rojo Gómez #1149,
Col. Guadalupe del Moral
C.P. 09300, México, D.F., México
Tel: 55-5804-0600

BRAZIL

Yamaha Musical do Brasil Ltda.
Rua Joaquim Floriano, 913 - 4º andar, Itaim Bibi,
CEP 04534-013 Sao Paulo, SP. BRAZIL
Tel: 011-3704-1377

ARGENTINA

Yamaha Music Latin America, S.A.
Sucursal de Argentina
Viamonte 1145 Piso2-B 1053,
Buenos Aires, Argentina
Tel: 1-4371-7021

PANAMA AND OTHER LATIN AMERICAN COUNTRIES/ CARIBBEAN COUNTRIES

Yamaha Music Latin America, S.A.
Torre Banco General, Piso 7, Urbanización Marbella,
Calle 47 y Aquilino de la Guardia,
Ciudad de Panamá, Panamá
Tel: +507-269-5311

EUROPE

THE UNITED KINGDOM

Yamaha-Kemble Music (U.K.) Ltd.
Sherbourne Drive, Tilbrook, Milton Keynes,
MK7 8BL, England
Tel: 01908-366700

IRELAND

Danfay Ltd.
61D, Sallynoggin Road, Dun Laoghaire, Co. Dublin
Tel: 01-2859177

GERMANY

Yamaha Music Central Europe GmbH
Siemensstraße 22-34, 25462 Rellingen, Germany
Tel: 04101-3030

SWITZERLAND/LIECHTENSTEIN

Yamaha Music Central Europe GmbH,
Branch Switzerland
Seefeldstrasse 94, 8008 Zürich, Switzerland
Tel: 01-383 3990

AUSTRIA

Yamaha Music Central Europe GmbH,
Branch Austria
Schleiergasse 20, A-1100 Wien, Austria
Tel: 01-60203900

CZECH REPUBLIC/SLOVAKIA/ HUNGARY/SLOVENIA

Yamaha Music Central Europe GmbH,
Branch Austria, CEE Department
Schleiergasse 20, A-1100 Wien, Austria
Tel: 01-602039025

POLAND

Yamaha Music Central Europe GmbH
Sp.z o.o. Oddział w Polsce
ul. 17 Stycznia 56, PL-02-146 Warszawa, Poland
Tel: 022-868-07-57

THE NETHERLANDS/ BELGIUM/LUXEMBOURG

Yamaha Music Central Europe GmbH,
Branch Benelux
Clarissenhof 5-b, 4133 AB Vianen, The Netherlands
Tel: 0347-358 040

FRANCE

Yamaha Musique France
BP 70-77312 Marne-la-Vallée Cedex 2, France
Tel: 01-64-61-4000

ITALY

Yamaha Musica Italia S.P.A.
Viale Italia 88, 20020 Lainate (Milano), Italy
Tel: 02-935-771

SPAIN/PORTUGAL

Yamaha-Hazen Música, S.A.
Ctra. de la Coruna km. 17, 200, 28230
Las Rozas (Madrid), Spain
Tel: 91-639-8888

GREECE

Philippos Nakas S.A. The Music House
147 Skiathou Street, 112-55 Athens, Greece
Tel: 01-228 2160

SWEDEN

Yamaha Scandinavia AB
J. A. Wettergrens Gata 1
Box 30053
S-400 43 Göteborg, Sweden
Tel: 031 89 34 00

DENMARK

YS Copenhagen Liaison Office
Generatorvej 6A
DK-2730 Herlev, Denmark
Tel: 44 92 49 00

FINLAND

F-Musiikki Oy
Kluuvikatu 6, P.O. Box 260,
SF-00101 Helsinki, Finland
Tel: 09 618511

NORWAY

Norsk filial av Yamaha Scandinavia AB
Grini Næringspark 1
N-1345 Østerås, Norway
Tel: 67 16 77 70

ICELAND

Skifan HF
Skeifan 17 P.O. Box 8120
IS-128 Reykjavik, Iceland
Tel: 525 5000

OTHER EUROPEAN COUNTRIES

Yamaha Music Central Europe GmbH
Siemensstraße 22-34, 25462 Rellingen, Germany
Tel: +49-4101-3030

AFRICA

Yamaha Corporation,
Asia-Pacific Music Marketing Group
Nakazawa-cho 10-1, Hamamatsu, Japan 430-8650
Tel: +81-53-460-2312

MIDDLE EAST

TURKEY/CYPRUS

Yamaha Music Central Europe GmbH
Siemensstraße 22-34, 25462 Rellingen, Germany
Tel: 04101-3030

OTHER COUNTRIES

Yamaha Music Gulf FZE
LOB 16-513, P.O.Box 17328, Jubel Ali,
Dubai, United Arab Emirates
Tel: +971-4-881-5868

ASIA

THE PEOPLE'S REPUBLIC OF CHINA

Yamaha Music & Electronics (China) Co.,Ltd.
25/F., United Plaza, 1468 Nanjing Road (West),
Jingan, Shanghai, China
Tel: 021-6247-2211

HONG KONG

Tom Lee Music Co., Ltd.
11/F., Silvercord Tower 1, 30 Canton Road,
Tsimshatsui, Kowloon, Hong Kong
Tel: 2737-7688

INDONESIA

PT. Yamaha Music Indonesia (Distributor)
PT. Nusantik
Gedung Yamaha Music Center, Jalan Jend. Gatot
Subroto Kav. 4, Jakarta 12930, Indonesia
Tel: 21-520-2577

KOREA

Yamaha Music Korea Ltd.
8F, 9F, Dongsung Bldg. 158-9 Samsung-Dong,
Kangnam-Gu, Seoul, Korea
Tel: 080-004-0022

MALAYSIA

Yamaha Music Malaysia, Sdn., Bhd.
Lot 8, Jalan Perbandaran, 47301 Kelana Jaya,
Petaling Jaya, Selangor, Malaysia
Tel: 3-78030900

PHILIPPINES

Yupangco Music Corporation
339 Gil J. Puyat Avenue, P.O. Box 885 MCPO,
Makati, Metro Manila, Philippines
Tel: 819-7551

SINGAPORE

Yamaha Music Asia Pte., Ltd.
#03-11 A-Z Building
140 Paya Lebor Road, Singapore 409015
Tel: 747-4374

TAIWAN

Yamaha KHS Music Co., Ltd.
3F, #6, Sec.2, Nan Jing E. Rd. Taipei.
Taiwan 104, R.O.C.
Tel: 02-2511-8688

THAILAND

Siam Music Yamaha Co., Ltd.
891/1 Siam Motors Building, 15-16 floor
Rama 1 road, Wangmai, Pathumwan
Bangkok 10330, Thailand
Tel: 02-215-2626

OTHER ASIAN COUNTRIES

Yamaha Corporation,
Asia-Pacific Music Marketing Group
Nakazawa-cho 10-1, Hamamatsu, Japan 430-8650
Tel: +81-53-460-2317

OCEANIA

AUSTRALIA

Yamaha Music Australia Pty. Ltd.
Level 1, 99 Queensbridge Street, Southbank,
Victoria 3006, Australia
Tel: 3-9693-5111

NEW ZEALAND

Music Houses of N.Z. Ltd.
146/148 Captain Springs Road, Te Papapa,
Auckland, New Zealand
Tel: 9-634-0099

COUNTRIES AND TRUST TERRITORIES IN PACIFIC OCEAN

Yamaha Corporation,
Asia-Pacific Music Marketing Group
Nakazawa-cho 10-1, Hamamatsu, Japan 430-8650
Tel: +81-53-460-2312



Yamaha Manual Library
<http://www.yamaha.co.jp/manual/>

U.R.G., Pro Audio & Digital Musical Instrument Division, Yamaha Corporation
© 2006 Yamaha Corporation
WJ07570 xxxMWDHx.x-01A0
Printed in Japan