



UABGLV

# musicCast WX-010



WIRELESS STREAMING SPEAKER

OWNER'S MANUAL

Before using this unit, be sure to read the "Safety Brochure" and "Quick Manual."

EN

# IMPORTANT SAFETY INSTRUCTIONS

	<b>CAUTION</b> <b>RISK OF ELECTRIC SHOCK DO NOT OPEN</b>	
<b>CAUTION: TO REDUCE THE RISK OF ELECTRIC SHOCK, DO NOT REMOVE COVER (OR BACK). NO USER-SERVICEABLE PARTS INSIDE. REFER SERVICING TO QUALIFIED SERVICE PERSONNEL.</b>		

## • Explanation of Graphical Symbols



The lightning flash with arrowhead symbol, within an equilateral triangle, is intended to alert you to the presence of uninsulated "dangerous voltage" within the product's enclosure that may be of sufficient magnitude to constitute a risk of electric shock to persons.



The exclamation point within an equilateral triangle is intended to alert you to the presence of important operating and maintenance (servicing) instructions in the literature accompanying the appliance.

## IMPORTANT

Please record the serial number of this unit in the space below.

**MODEL:**

**Serial No.:**

The serial number is located on the rear of the unit. Retain this Owner's Manual in a safe place for future reference.

- 1 Read these instructions.
- 2 Keep these instructions.
- 3 Heed all warnings.
- 4 Follow all instructions.
- 5 Do not use this apparatus near water.
- 6 Clean only with dry cloth.
- 7 Do not block any ventilation openings. Install in accordance with the manufacturer's instructions.
- 8 Do not install near any heat sources such as radiators, heat registers, stoves, or other apparatus (including amplifiers) that produce heat.
- 9 Do not defeat the safety purpose of the polarized or grounding-type plug. A polarized plug has two blades with one wider than the other. A grounding type plug has two blades and a third grounding prong. The wide blade or the third prong are provided for your safety. If the provided plug does not fit into your outlet, consult an electrician for replacement of the obsolete outlet.
- 10 Protect the power cord from being walked on or pinched particularly at plugs, convenience receptacles, and the point where they exit from the apparatus.
- 11 Only use attachments/accessories specified by the manufacturer.
- 12 Use only with the cart, stand, tripod, bracket, or table specified by the manufacturer, or sold with the apparatus. When a cart is used, use caution when moving the cart/apparatus combination to avoid injury from tip-over.
- 13 Unplug this apparatus during lightning storms or when unused for long periods of time.
- 14 Refer all servicing to qualified service personnel. Servicing is required when the apparatus has been damaged in any way, such as power-supply cord or plug is damaged, liquid has been spilled or objects have fallen into the apparatus, the apparatus has been exposed to rain or moisture, does not operate normally, or has been dropped.



## We Want You Listening For A Lifetime



Yamaha and the Electronic Industries Association's Consumer Electronics Group want you to get the most out of your equipment by playing it at a safe level. One that lets the sound come through loud and clear without annoying blaring or distortion – and, most importantly, without affecting your sensitive hearing. Since hearing damage from loud sounds is often undetectable until it is too late, Yamaha and the Electronic Industries Association's Consumer Electronics Group recommend you to avoid prolonged exposure from excessive volume levels.

## FCC INFORMATION (for US customers)

### 1 **IMPORTANT NOTICE: DO NOT MODIFY THIS UNIT!**

This product, when installed as indicated in the instructions contained in this manual, meets FCC requirements. Modifications not expressly approved by Yamaha may void your authority, granted by the FCC, to use the product.

### 2 **IMPORTANT:** When connecting this product to accessories and/or another product use only high quality shielded cables. Cable/s supplied with this product **MUST** be used. Follow all installation instructions. Failure to follow instructions could void your FCC authorization to use this product in the USA.

### 3 **NOTE:** This product has been tested and found to comply with the requirements listed in FCC Regulations, Part 15 for Class "B" digital devices. Compliance with these requirements provides a reasonable level of assurance that your use of this product in a residential environment will not result in harmful interference with other electronic devices. This equipment generates/uses radio frequencies and, if not installed and used according to the instructions found in the users manual, may cause interference harmful to the operation of other electronic devices.

Compliance with FCC regulations does not guarantee that interference will not occur in all installations. If this product is found to be the source of interference, which can be determined by turning the unit "OFF" and "ON", please try to eliminate the problem by using one of the following measures:

Relocate either this product or the device that is being affected by the interference.

Utilize power outlets that are on different branch (circuit breaker or fuse) circuits or install AC line filter/s.

In the case of radio or TV interference, relocate/reorient the antenna. If the antenna lead-in is 300 ohm ribbon lead, change the lead-in to coaxial type cable.

If these corrective measures do not produce satisfactory results, please contact the local retailer authorized to distribute this type of product. If you can not locate the appropriate retailer, please contact Yamaha Corporation of America A/V Division, 6660 Orangethorpe Ave., Buena Park, CA 90620.

The above statements apply **ONLY** to those products distributed by Yamaha Corporation of America or its subsidiaries.

This device complies with part 15 of FCC Rules and Industry Canada's licence-exempt RSSs. Operation is subject to the following two conditions: (1) this device may not cause harmful interference, and (2) this device must accept any interference received, including interference that may cause undesired operation.

### **NOTICE**

This equipment has been tested and found to comply with the limits for a Class B digital device, pursuant to part 15 of the FCC Rules. These limits are designed to provide reasonable protection against harmful interference in a residential installation.

This equipment generates, uses and can radiate radio frequency energy and, if not installed and used in accordance with the instructions, may cause harmful interference to radio communications. However, there is no guarantee that interference will not occur in a particular installation. If this equipment does cause harmful interference to radio or television reception, which can be determined by turning the equipment off and on, the user is encouraged to try to correct the interference by one or more of the following measures:

- Reorient or relocate the receiving antenna.
- Increase the separation between the equipment and receiver.
- Connect the equipment into an outlet on a circuit different from that to which the receiver is connected.
- Consult the dealer or an experienced radio/TV technician for help.

This equipment complies with FCC/IC radiation exposure limits set forth for an uncontrolled environment and meets the FCC radio frequency (RF) Exposure Guidelines and RSS-102 of the IC radio frequency (RF) Exposure rules. This equipment should be installed and operated keeping the radiator at least 20cm or more away from person's body.

This transmitter must not be co-located or operated in conjunction with any other antenna or transmitter.

### **FCC CAUTION**

Change or modifications not expressly approved by the party responsible for compliance could void the user's authority to operate the equipment.

### **FOR CANADIAN CUSTOMERS**

To prevent electric shock, match wide blade of plug to wide slot and fully insert.  
CAN ICE-3 (B)/NMB-3 (B)

## CAUTION: READ THIS BEFORE OPERATING YOUR UNIT.

- 1 To assure the finest performance, please read this manual carefully. Keep it in a safe place for future reference.
- 2 Install this unit in a well ventilated, cool, dry, clean place – away from direct sunlight, heat sources, vibration, dust, moisture and cold. For proper ventilation, allow the following minimum clearances.  
Top: 5 cm (2 in)  
Rear: 5 cm (2 in)  
Sides: 5 cm (2 in)
- 3 Locate this unit away from other electrical appliances, motors, or transformers to avoid humming sounds.
- 4 Do not expose this unit to sudden temperature changes from cold to hot (or vice versa), and do not locate this unit in an environment with high humidity (i.e., a room with a humidifier) to prevent condensation inside this unit, which may cause an electrical shock, fire, damage to this unit, and/or personal injury.
- 5 Avoid installing this unit where foreign object may fall onto this unit and/or this unit may be exposed to liquid dripping or splashing. On the top of this unit, do not place:
  - Other components, as they may cause damage and/or discoloration on the surface of this unit.
  - Burning objects (i.e., candles), as they may cause fire, damage to this unit, and/or personal injury.
  - Containers with liquid in them, as they may fall and liquid may cause electrical shock to the user and/or damage to this unit.
- 6 Do not cover this unit with a newspaper, tablecloth, curtain, etc. in order not to obstruct heat radiation. If the temperature inside this unit rises, it may cause fire, damage to this unit, and/or personal injury.
- 7 Do not plug in this unit to a wall outlet until all connections are complete.
- 8 Do not operate this unit upside-down. It may overheat, possibly causing damage.
- 9 Do not use force on switches, knobs and/or cords.
- 10 When disconnecting the power cable from the wall outlet, grasp the plug; do not pull the cable.
- 11 Do not clean this unit with chemical solvents; this might damage the finish. Use a clean, dry cloth.
- 12 Only voltage specified on this unit must be used. Using this unit with a higher voltage than specified is dangerous and may cause fire, damage to this unit, and/or personal injury. Yamaha will not be held responsible for any damage resulting from use of this unit with a voltage other than specified.
- 13 To prevent damage by lightning, keep the power cable and outdoor antennas disconnected from a wall outlet or this unit during a lightning storm.
- 14 Do not attempt to modify or fix this unit. Contact qualified Yamaha service personnel when any service is needed. The cabinet should never be opened for any reasons.
- 15 When not planning to use this unit for long periods of time (i.e., vacation), disconnect the AC power plug from the wall outlet.
- 16 Be sure to read the “TROUBLESHOOTING” section on common operating errors before concluding that this unit is faulty.
- 17 Before moving this unit, press  to set the unit to off, and disconnect the AC power plug from the wall outlet.
- 18 Condensation will form when the surrounding temperature changes suddenly. Disconnect the power cable from the outlet, then leave this unit alone.
- 19 When using this unit for a long time, this unit may become warm. Turn the unit off, then leave this unit alone for cooling.
- 20 Install this unit near the wall outlet and where the AC power plug can be reached easily.
- 21 Be sure to use the power cable supplied with this unit. Using a power cable other than the one provided may cause fire or damage to this unit.

This unit is not disconnected from the AC power source as long as it is connected to the wall outlet, even if this unit itself is turned off by . In this state, this unit is designed to consume a very small quantity of power.

**WARNING**  
TO REDUCE THE RISK OF FIRE OR ELECTRIC SHOCK, DO NOT EXPOSE THIS UNIT TO RAIN OR MOISTURE.

- This unit's speakers use magnets. Do not place items that are sensitive to magnetism, such as CRT-type TVs, clocks, credit cards, floppy disks, etc., on or beside this unit.
- There is a chance that placing this unit too close to a CRT-based (Braun tube) TV set might impair picture color. Should this happen, move this unit away from the TV set.

### ◆ For U.K. customers

If the socket outlets in the home are not suitable for the plug supplied with this appliance, it should be cut off and an appropriate 3 pin plug fitted. For details, refer to the instructions described below.

The plug severed from the mains lead must be destroyed, as a plug with bare flexible cord is hazardous if engaged in a live socket outlet.

## ◆ Special Instructions for U.K. Model

### IMPORTANT

THE WIRES IN MAINS LEAD ARE COLOURED IN ACCORDANCE WITH THE FOLLOWING CODE:

Blue: NEUTRAL

Brown: LIVE

As the colours of the wires in the mains lead of this apparatus may not correspond with the coloured markings identifying the terminals in your plug, proceed as follows:

The wire which is coloured BLUE must be connected to the terminal which is marked with the letter N or coloured BLACK. The wire which is coloured BROWN must be connected to the terminal which is marked with the letter L or coloured RED.

Make sure that neither core is connected to the earth terminal of the three pin plug.

If there should be color blotching or noise when used near a TV, move this unit away from the TV when using it.

Do not use this unit within 22 cm (9 inches) of persons with a heart pacemaker implant or defibrillator implant.

Radio waves may affect electro-medical devices. Do not use this unit near medical devices or inside medical facilities.

The user shall not reverse engineer, decompile, alter, translate or disassemble the software used in this unit, whether in part or in whole. For corporate users, employees of the corporation itself as well as its business partners shall observe the contractual bans stipulated within this clause. If the stipulations of this clause and this contract cannot be observed, the user shall immediately discontinue using the software.

### Information for Users on Collection and Disposal of Old Equipment:



This symbol on the products, packaging, and/or accompanying documents means that used electrical and electronic products should not be mixed with general household waste.

For proper treatment, recovery and recycling of old products, please take them to applicable collection points, in accordance with your national legislation.

By disposing of these products correctly, you will help to save valuable resources and prevent any potential negative effects on human health and the environment which could otherwise arise from inappropriate waste handling.

For more information about collection and recycling of old products, please contact your local municipality, your waste disposal service or the point of sale where you purchased the items.

#### For business users in the European Union:

If you wish to discard electrical and electronic equipment, please contact your dealer or supplier for further information.

#### Information on Disposal in other Countries outside the European Union:

This symbol is only valid in the European Union. If you wish to discard these items, please contact your local authorities or dealer and ask for the correct method of disposal.

### ◆ About this manual

- “iPhone” described in this manual may also refer to “iPod” or “iPad.”
- Illustrations may differ from actual item depicted.
- Symbols:

**Note** Indicates precautions for use of the unit and its feature limitations.



Indicates supplementary explanations for better use.



Indicates the corresponding reference page(s).

# FEATURES

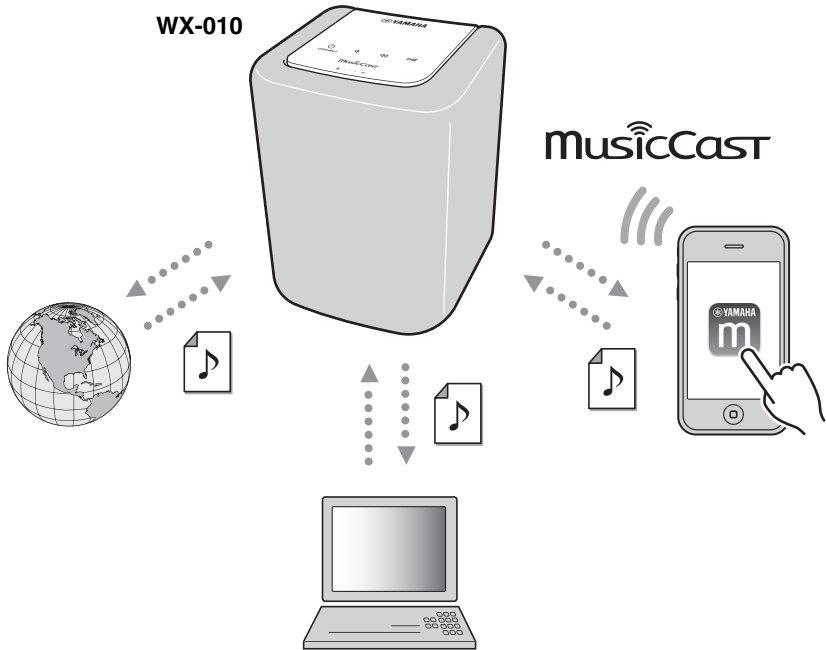

## Smooth operation and wireless music playback using iPhone/Android™ devices

- By installing the free dedicated app “MusicCast CONTROLLER” on your iPhone/iPad/iPod touch or Android device, you will be able to set up a network, make various settings, and select songs to play back. You can also use these devices as a remote controller (☞ P.7).
- Equipped with Wi-Fi, which allows the unit to connect to the wireless router (access point) without any cables.

## Plays various supported content with high quality sound

- Plays music from DLNA servers/Internet radio (☞ P.17), AirPlay and *Bluetooth*.
- Rich sound provided by the two-way speaker, large passive radiator, and DSP (Digital Signal Processor) developed by Yamaha.
- Enhanced treble and thick mid/bass sound, even when playing a compressed audio source, such as MP3. (Music Enhancer)

## Supports streaming services

- You can enjoy music from a variety streaming services. (Supported music streaming services vary by the country or region of use.)

## Stereo Pair function

- You can enjoy stereo reproduction using two WX-010 units.

# CONTENTS

## ◆ INTRODUCTION

SUPPLIED ACCESSORIES.....	2
PART NAME .....	3

## ◆ PREPARATION

INSTALLATION .....	4
Mounting the unit on a wall (Except for U.S.A. and Canada model).....	4
TURNING ON THE POWER .....	5
CONNECTING TO THE NETWORK .....	6
HOME AUDIO NETWORK WITH MusicCast.....	7
Connecting to the network using MusicCast CONTROLLER .....	7
CONNECTING TO THE NETWORK BY SHARING THE iOS DEVICE SETTING.....	9

## ◆ LISTENING TO THE MUSIC

LISTENING TO THE INTERNET RADIO .....	10
LISTENING TO THE SONGS IN THE COMPUTER AND NAS.....	10
Setting the media sharing of music files .....	10
PLAYING BACK MUSIC WITH AirPlay .....	11
Playback of iTunes/iPhone music contents.....	11
Clearing AirPlay.....	11
LISTENING TO MUSIC FROM YOUR <i>Bluetooth</i> DEVICE .....	12
Pairing this unit with your <i>Bluetooth</i> device.....	12
Connecting an already-paired device via <i>Bluetooth</i> .....	12
Disconnecting a <i>Bluetooth</i> connection .....	12
Listening to music through wireless headphones .....	13

## ◆ OTHER FUNCTIONS AND INFORMATION

STEREO PAIR .....	14
Setting/Playing back music .....	14
Canceling Stereo Pair .....	15
UPDATING THE FIRMWARE .....	16
OPTION SETTINGS.....	16
ADDITIONAL INFORMATION .....	17
TRADEMARKS .....	17
TROUBLESHOOTING .....	18
General.....	18
MusicCast.....	18
Network .....	18
<i>Bluetooth</i> .....	20
SUPPORTED DEVICES/MEDIA AND FILE FORMATS.....	21
SPECIFICATIONS.....	22

# SUPPLIED ACCESSORIES

- Power cable

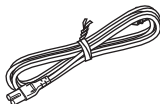

- Anti-vibration pad



(Except for U.S.A.  
and Canada model)

- Quick Manual

- Safety Brochure

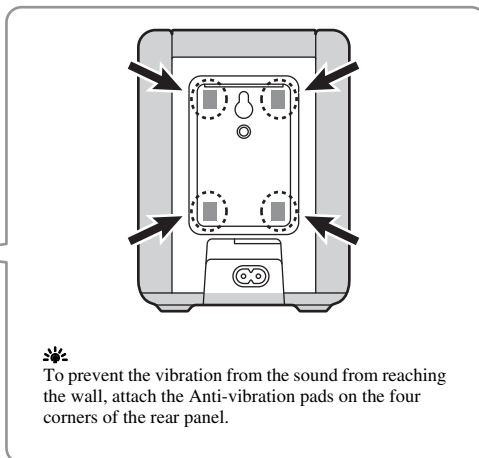

To prevent the vibration from the sound from reaching the wall, attach the Anti-vibration pads on the four corners of the rear panel.

# PART NAME

## ■ Top panel

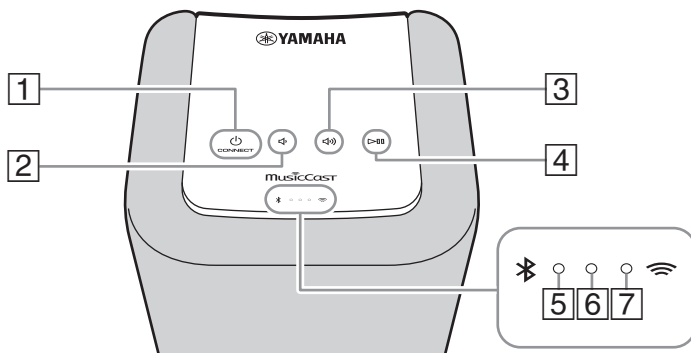

1 (power)/CONNECT (P.5, 7)

2 Turns down the volume.

3 Turns up the volume.

4 Plays/pauses.

5 **Bluetooth indicator**

Lights during Bluetooth connection.

6 **Power indicator**

Lights while the unit is turned on.

7 **Wi-Fi indicator**

Lights while the unit is connected to the wireless (Wi-Fi) network.



1, 2, 3, 4 are touch sensors. They react when you touch them with your finger.

### Note

If the volume reaches the maximum/minimum value, these three indicators (5, 6, 7) flash twice at the same time.

## ■ Rear panel

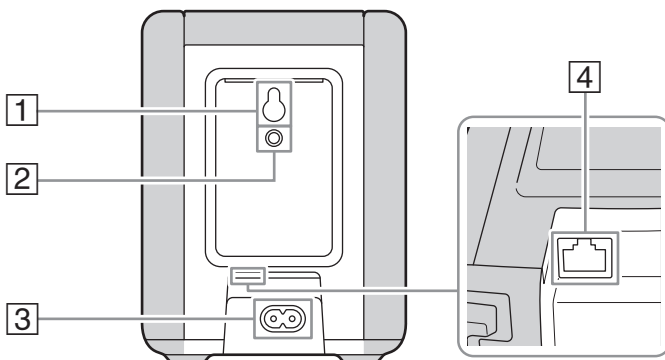

1 **Key hole slot** (P.4)  
(Except for U.S.A. and Canada model)

2 **Wall mount hanger hole** (P.5)  
Use to mount the unit to a wall mount hanger.

3 **Power connector** (P.5)

4 **Network terminal** (P.6)

Use a network cable (commercially available) to connect to the network.



If you use the unit with Wi-Fi, a network cable is not necessary to connect to the unit.



# INSTALLATION

Plug the power cable into the wall outlet after completing installation.

## Note

- Placing the unit too close to a CRT TV may impair the picture color or cause a buzzing noise. In this case, move the unit at least 20 cm (8") away from the TV. This is not an issue with LCD and plasma TVs.
- Install in a stable place, being careful of the following points:
  - Do not place on top of steel or other metal plates.
  - Do not cover with a cloth, etc.

## Mounting the unit on a wall (Except for U.S.A. and Canada model)

You can mount the unit on the wall as follows.

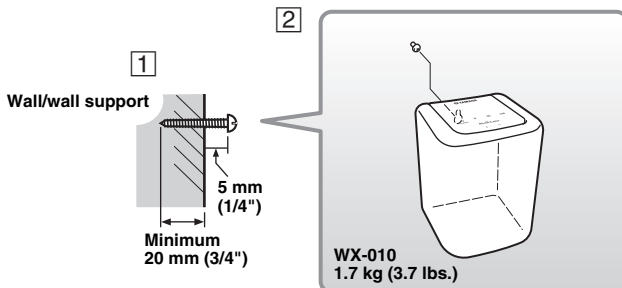

- 1 Install screw (commercially available) into a solid wall or wall support as shown in the illustration. Use 3.5 to 4 mm (1/8") diameter self-tapping screw.
- 2 Hang the unit by its keyhole slot onto the protruding screw.

## Note

- Make sure the shaft of the screw is seated in the narrow part of the keyhole slot. Otherwise, the unit may fall.
- Do not mount the unit on thin plywood or on a wall with a soft surface material. Otherwise, the screw may pull out of the surface and the unit may fall, possibly damaging the unit or causing personal injury.
- Do not affix the unit to a wall using nails, adhesives, or unstable hardware. Long-term use and vibration may cause the unit to fall.
- To avoid accidents resulting from tripping over loose cables (such as a power cable), affix the cables to the wall.
- When using the brackets to mount the unit on a wall / ceiling, please use safety wire (not included) between the unit and the bracket to prevent the unit from falling.
- If you are not sure of a safe way to install the unit, consult a professional installer or a building contractor.
- To prevent the vibration from the sound from reaching the wall, attach the Anti-vibration pads on the four corners of the rear panel (☞ P.2).

## ■ To mount the unit to a wall mount hanger

The unit can be mounted to the wall using a commercially available wall mount hanger. Use the wall mount hanger hole on the rear panel to mount.



Use a wall mount hanger that is compatible for a unified coarse screw, such as those used for the tripod stand of a camera.

### Rear panel

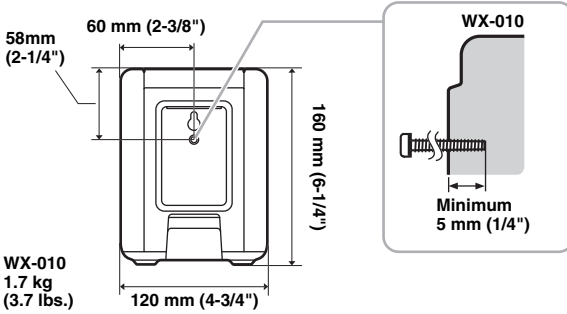

Specification of mounting screw:  
UNC 1/4-20

Diameter	6.35 mm (1/4")
Screw thread	20 (per 1")

Specifications of the screw hole

Diameter	6.35 mm (1/4")
Depth	9 mm (3/8")

### Note

- If using a wall mount hanger, use the one compatible for this unit.
- Use the wall mount hanger whose withstand load capacity is over 4.5 kg (10 lbs.).
- Follow the instructions in the owner's manual of the wall mount hanger and mount the unit correctly.
- If you mount the unit incorrectly or use a wall mount hanger that is not compatible for the unit, the unit may fall and cause injury.
- Check the safety after mounting the unit. Yamaha is not responsible for any accidents which may be caused due to an incorrect installation position or incorrect installation methods, or for any malfunction of the wall mount hanger. If you are worried about the safety, ask a professional to install.

## TURNING ON THE POWER

### Rear panel

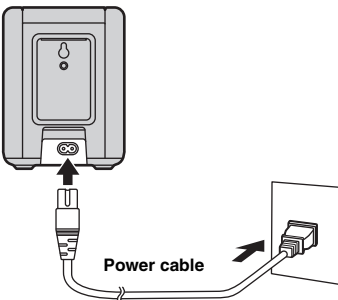

- 1 Plug the power cable into the wall outlet and tap (power)/CONNECT.

The unit turns on and the power indicator lights. If you tap again, the unit turns off (standby) and the power indicator turns off.

### Note

- After the power plug is inserted into the wall outlet, it takes about 10 seconds for the touch sensors to be adjusted. In order to prevent malfunction of the touch sensors, do not touch them () (power)/CONNECT/ / / or play back for about 10 seconds.

### Auto Standby

If about 20 minutes have elapsed with no playback and no operation while the unit is on, it will automatically enter standby.

You can change the auto standby function setting in the MusicCast CONTROLLER app (P.7). Tap (Settings) in the room select display, and then change the setting.

### Top panel

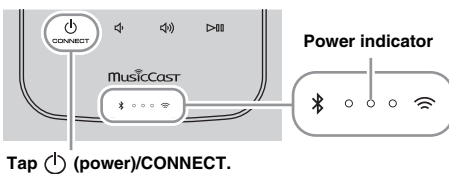

# CONNECTING TO THE NETWORK

Connect the unit to the network as shown below.

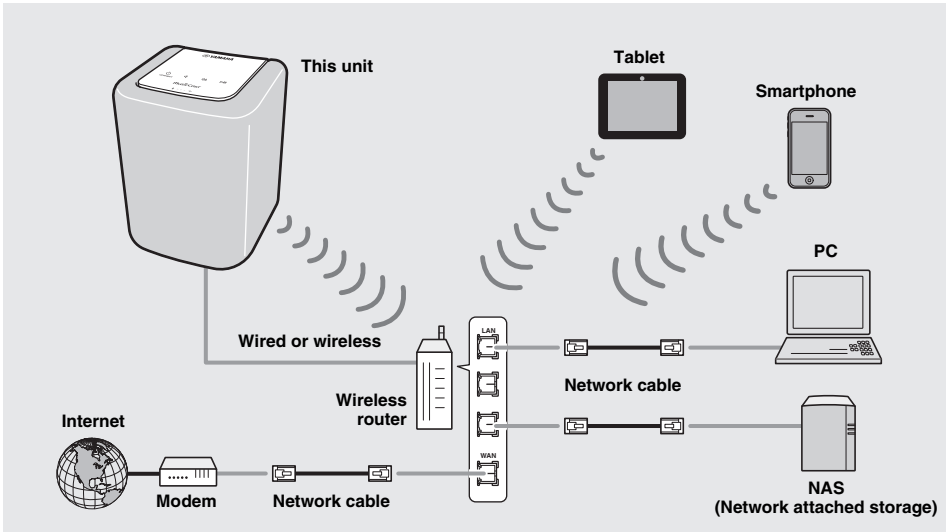

- For details on Internet connection, refer to the owner's manuals of your connecting devices.
- Some security software installed on your PC or the firewall settings of connecting devices (such as a router) may block the access of the unit to the connecting devices or the Internet. In this case, change the setting of the security software or connecting devices.
- If you connect the unit to the network with a network cable, connect with a commercially available STP (shielded twisted pair) network cable (straight, CAT-5 or higher).
- Using the MusicCast CONTROLLER app, make sure that the unit and other connecting devices are connected to the same router (see P.7).

# HOME AUDIO NETWORK WITH MusicCast

MusicCast is a brand new wireless musical solution from Yamaha, allowing you to share music among all of your rooms with a variety of devices. You can enjoy music from your smartphone, PC, NAS drive and music streaming service anywhere in your house with one easy-to-use app. For more details and a lineup of MusicCast compatible products, visit our website.

<http://www.yamaha.com/musiccast/>

## ■ MusicCast CONTROLLER

### • Main functions

- Basic operations such as turning the unit on/off and, volume adjustment
- Select/play/pause the music
- Play music in the devices
- Listening to the Internet radio
- Listening to the songs in the computer and NAS
- Playing back music with AirPlay
- Listening to music from your *Bluetooth* device
- Using the equalizer
- Using the sleep timer
- Updating the firmware

### • System requirements

- For details, search App Store or Google Play™ for “MusicCast CONTROLLER.”
  - The application supports iPhone/iPad/iPod touch and Android mobile devices.
- For details, refer to the instructions for this app in each store.
- Wireless network environment.

## Connecting to the network using MusicCast CONTROLLER

### ■ Mobile device (smartphone, etc.)

To use the unit, you need the dedicated app “MusicCast CONTROLLER” for the operation.

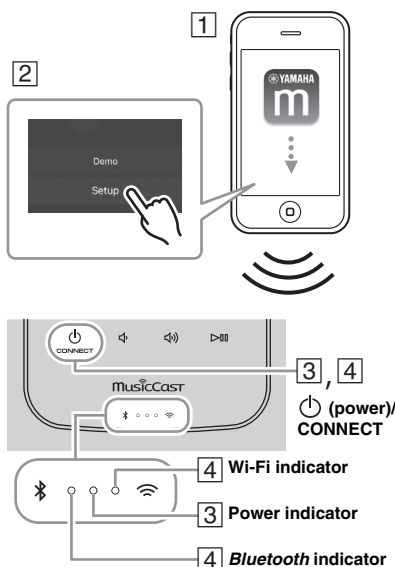

#### **1 Install the MusicCast CONTROLLER app to the mobile device.**

#### **2 Start the app.**

After the app starts, select “Setup.”



If you have already connected a MusicCast compatible device to the network, tap (Settings) in the room select display and then add this unit as a new device.

#### **3 Turn on the unit.**

The power indicator lights.

#### **4 Touch and hold the (power)/CONNECT on the unit for 5 seconds.**

The Wi-Fi and the *Bluetooth* indicators flash quickly. Follow the guidance displayed in the app to set.

#### **5 Follow the instructions in the MusicCast CONTROLLER app to play music.**

If your router supports multiple SSID's (network names), connect the mobile device to the first access point (“SSID 1”, etc.)

## ■ Setting of the devices and playback

Create the following network (MusicCast Network) using the MusicCast CONTROLLER app.

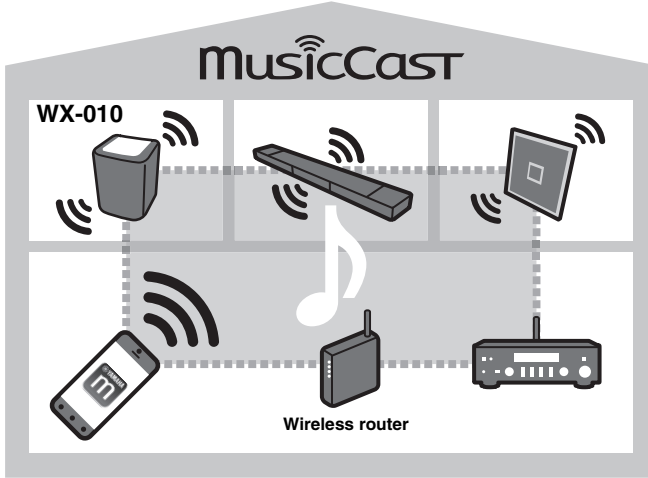

If you want to install a MusicCast compatible device to a location that is out of range of the wireless router, connect another MusicCast support device to the router with a network cable to extend the range (Extend mode).

### Standard Mode

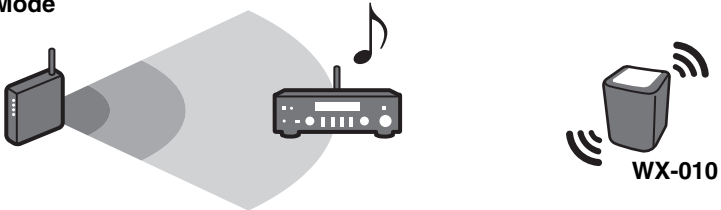

### Extend Mode

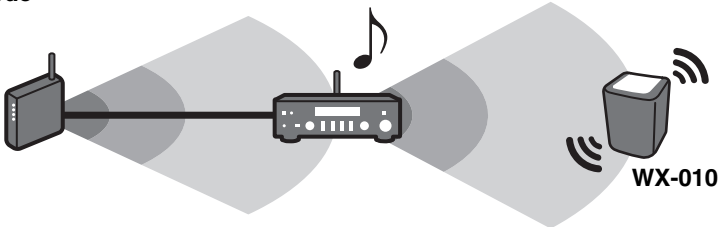

Depending on where it is placed, the MusicCast compatible device may not be able to playback a high-resolution audio source. In this case, connect the device directly to the router with a network cable.

# CONNECTING TO THE NETWORK BY SHARING THE iOS DEVICE SETTING

When you turn on the unit for the first time after purchase or initialize the unit (☞ P.16), the Wi-Fi indicator blinks and the unit automatically starts to search iOS device (such as iPhone). You can easily setup a wireless connection by applying the network settings on iOS devices.

Before proceeding, confirm that your iOS device is connected to a wireless router (access point).

This setting does not need to be specified if the unit is connected to a network with “MusicCast CONTROLLER.”

**1** **Display the Wi-Fi setup screen on the iOS device and select the unit from “SETUP A NEW AIRPLAY SPEAKER...”.**

- Follow the on-screen instructions displayed on the iOS device.
- In order to enjoy all of the unit’s functions, connect it to a network with “MusicCast CONTROLLER.” (☞ P.7)

**Note**

- You need iOS device with iOS 7.1 or later.
- The network settings on iOS devices cannot be applied to the unit to establish a wireless connection if your wireless router (access point) uses WEP encryption.

# LISTENING TO THE INTERNET RADIO

You can listen to world-wide radio stations via Internet. After connecting the unit to the network, use the MusicCast CONTROLLER app (☞ P.7) to play the radio.



You can use the advanced feature of vTuner (such as adding a new station to the list) by accessing the following website with the web browser on your PC.

<http://radio.vtuner.com/>

- Before registering the Internet radio station, play any Internet radio station with this unit.

- To create a necessary account for registration, you need the vTuner ID of this unit and your e-mail address. You can check the vTuner ID in the MusicCast CONTROLLER app. (☞ P.7)

Tap (Settings) in the room select display and then check the unit information.

# LISTENING TO THE SONGS IN THE COMPUTER AND NAS

This unit allows you to play back music files such as MP3, WMA, or FLAC (lossless audio data compression format) files stored in the computer (server) connected to the network or NAS.

## Setting the media sharing of music files

To play back music files in your computer with this unit, you need to make the media sharing setting between the unit and computer (Windows Media Player 11 or later). The following instructions use Windows Media Player 12 in Windows 7 as an example.

### ■ For Windows Media Player 12

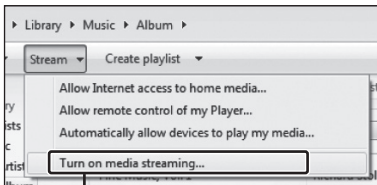

2 Turn on media streaming...

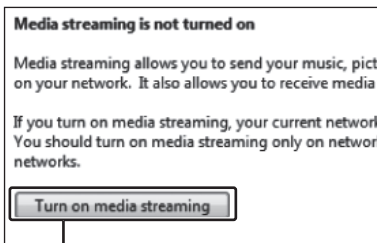

3 Turn on media streaming

Only setting the media sharing is explained in this section. After setting, operate Windows Media Player with your PC as usual to play back.

1 Start Windows Media Player 12 on your PC.

2 Select "Stream", then "Turn on media streaming."

The control panel window of your PC is shown.

3 Click "Turn on media streaming."

4 Select "Allowed" from the drop-down list next to "WX-010."

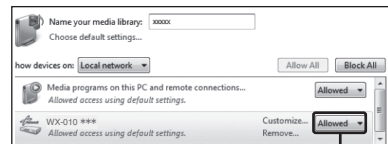

4 Allowed



The names on the list are device names (Room names). You can set Room names on (Settings) in the room select display. If the Room name is not set, the Room name is "WX-010 \*\*\*." (\*\*\*) is an arbitrary number.)

5 Click "OK" to exit.



For details on media sharing settings, refer to Windows Media Player help.

## ◆ For Windows Media Player 11

- 1 Start the Windows Media Player 11 on your PC.
- 2 Select “Library” then “Media Sharing.”
- 3 Check the “Share my media to” box, select the “WX-010” icon, and click “Allow.”



The names on the list are device names (Room names). You can set Room names on (Settings) in the room select display. If the Room name is not set, the Room name is “WX-010 \*\*\*,” (\*\*\*) is an arbitrary number.)

- 4 Click “OK” to exit.

## ◆ For a PC or a NAS with other DLNA server software installed

Refer to the owner’s manual of your device or software and configure the media sharing settings.

## PLAYING BACK MUSIC WITH AirPlay

### Playing abundant supported contents with high quality sound from AirPlay.

The AirPlay function allows you to play back iTunes/iPhone music on the unit wirelessly via a network.

### Playback of iTunes/iPhone music contents

Follow the procedure below to play back iTunes/iPhone music contents on the unit.

1



iTunes  
(example)



iPhone iOS9  
(example)

- 1 Turn on the unit, and start iTunes on the PC or display the playback screen on the iPhone.

If the iTunes/iPhone recognizes the unit, the AirPlay icon ( ) appears.

- 2 On the iTunes/iPhone, click (tap) the AirPlay icon and select the unit (room name of the unit) as the audio output device.

- 3 Select a song and start playback.

The source automatically switches to “AirPlay” and playback starts (except in the eco standby).

2

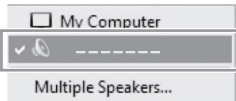

iTunes  
(example)



iPhone iOS9  
(example)

The unit’s room name is displayed where “-----” is indicated above.

### Clearing AirPlay

Click/tap on the iTunes/iPhone screen and select a device other than WX-010 from the speaker list. Or, change the source to other than AirPlay, using “MusicCast CONTROLLER.”



# LISTENING TO MUSIC FROM YOUR *Bluetooth* DEVICE

This unit provides *Bluetooth* functionality. You can enjoy wireless music playback from your *Bluetooth* device (smartphone, digital audio player, etc.). Please also refer to the owner's manual of your *Bluetooth* device.

- Install in the same room as the device with which signals are to be exchanged (*Bluetooth* profile A2DP compatible smartphone, digital audio player, etc.) within a direct line-of-sight distance of 10 m (33 ft).
- Make sure there are no obstacles between this unit and the *Bluetooth* device.

## Pairing this unit with your *Bluetooth* device

### ■ Pairing (Registration)

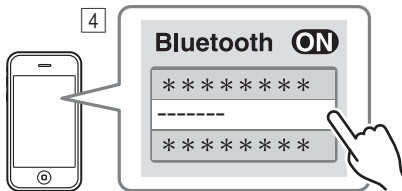
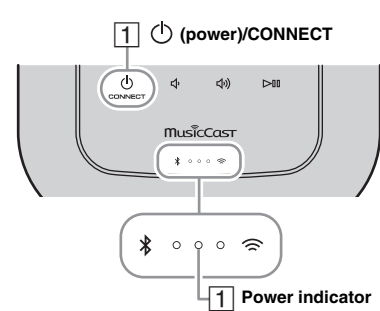

The unit's Room name is displayed where "-----" is indicated above.

- 1 Turn on the unit.**  
The power indicator lights.
- 2 On your connecting device (mobile device), set *Bluetooth* to on.**
- 3 Perform *Bluetooth* pairing on the connecting device.**  
For details, refer to the owner's manual of the connecting device.
- 4 From the *Bluetooth* connection list of the connecting device, choose this unit (the Room name of this unit ⓘ P.10).**



- Finish the operation from turning on the unit to completing pairing in 5 minutes.
- If you are asked to enter a password, enter the numerals "0000."

#### Note

Check that the pairing process on the connecting device has been completed. If the pairing process fails, start over from step [2]. For details, see the connecting device's owner's manual.

## Connecting an already-paired device via *Bluetooth*

### ■ Connecting from the connecting device

- 1 In the *Bluetooth* settings of the connecting device, turn *Bluetooth* on.**
- 2 From the *Bluetooth* connection list of the connecting device, choose this unit (the Room name of this unit ⓘ P.10).**

The *Bluetooth* connection will be established, and the *Bluetooth* indicator will light.

## Disconnecting a *Bluetooth* connection

If any of the following operations are performed while a *Bluetooth* connection is established, the *Bluetooth* connection will be disconnected.

- Tapping (power)/CONNECT to enter standby.
- Touching and holding for 3 seconds.
- Disconnecting the *Bluetooth* connection from the connecting device.

## Listening to music through wireless headphones

You can listen to the audio played back by this unit through *Bluetooth*-compatible wireless headphones. The audio will be transmitted to the wireless headphones using “MusicCast CONTROLLER” installed on your mobile device.

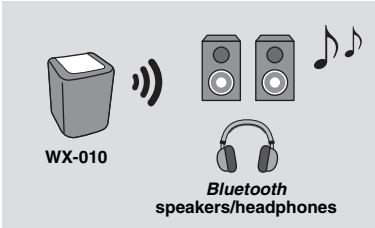

2



3

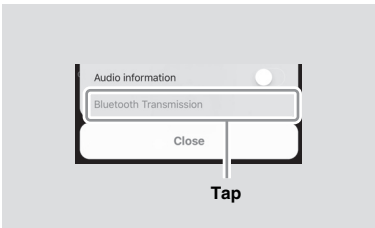

4

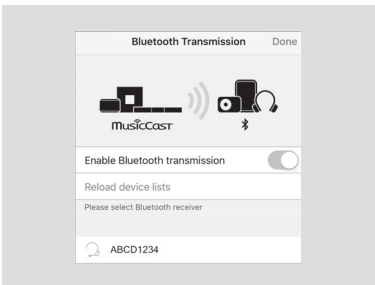

- 1 Set the *Bluetooth* connection for the *Bluetooth* device (wireless headphones, etc.) to standby.
- 2 Tap  in the playback display of “MusicCast CONTROLLER.”
- 3 Tap “*Bluetooth* Transmission.”
- 4 Select the *Bluetooth* device (wireless headphones, etc.).

When the connection is established, the *Bluetooth* indicator (P.3) lights up.

- 5 Tap “Done.”

The sound is output by the receiving *Bluetooth* device (wireless headphones, etc.).

### Note

- Use *Bluetooth* devices compatible with the A2DP profile.
- Audio from AirPlay or a *Bluetooth* device cannot be transmitted to and output by another *Bluetooth* device.



- The playback sound is also output by the unit.
- The “MusicCast CONTROLLER” app displays shown here are from an iPhone.
- For details on using your *Bluetooth* device, refer to its owner’s manual.

# STEREO PAIR

You can use two WX-010 units to reproduce stereo sound by setting each speaker as the right or left speaker.

Set the left and right speakers separately by following the steps below.

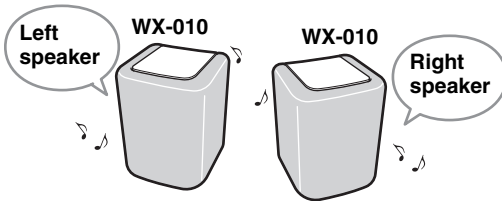

## Note

- To use the Stereo Pair function, you need two WX-010.
- Stereo Pair is available only when the Network Standby of the unit is enabled (☞ P.16).

## Setting/Playing back music

**1** Connect each WX-010 to the same network by using the dedicated app “MusicCast CONTROLLER.”

If the WX-010 is linked to another MusicCast unit, first disconnect the link by using the dedicated app “MusicCast CONTROLLER.”

**2** Tap **⏻** (power)/**CONNECT** of each unit to set them to standby.

**3** Tap and hold the following together for 3 seconds to set the left/right speakers.

① For setting the left speaker: **⏻** and **▶▶**

Indicators light from right to left repeatedly (refer to **A** of the table), and the unit enters pairing standby.

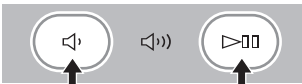



② For setting the right speaker: **⏻** and **▶▶**

Indicators light from left to right repeatedly (refer to **B** of the table), and the units start pairing.



## Indicator display during the Stereo Pair

Stereo Pair status	Indicator display
Start Pairing/ Checking the Left and Right Speaker	<b>A</b> Left speaker <b>B</b> Right speaker   <b>Right-to-Left</b> <b>Left-to-Right</b>
Pairing Completed	<b>C</b>  <b>Center to both sides</b>

After pairing is completed, the indicators light from the center to both sides (refer to **C** of the table), and all indicators return to the normal status.

**4** Use the dedicated app “MusicCast CONTROLLER” to play back.







- You can check which speaker is the left or right speaker with the dedicated app “MusicCast CONTROLLER” (Indicators light as **A** or **B** of the table).
- In Stereo Pair mode, you can operate one speaker to simultaneously turn off both speakers or adjust the volume of both speakers.
- If about five minutes passes while the unit cannot find the other speaker to connect to, the pairing standby will be cancelled automatically.
- When in Stereo Pair mode, the option settings other than “Initialize the unit.” (☞ P.16) cannot be set.

## Note

The Stereo Pair setting remains even if the speakers enter standby or the power cable is unplugged and plugged again.

## Canceling Stereo Pair

- 1 Tap  (**power**)/**CONNECT** to set the left and right speakers to the standby.
- 2 Tap and hold  (or )) and  on either speaker together for 3 seconds.

Indicators light from both sides to the center and Stereo Pair will be canceled.

Indicator display



Both sides to center

### Note

- The Stereo Pair can be canceled only during standby.
- If you cancel Stereo Pair with one of the two speakers, the other one will be canceled automatically.
- If one of the two speakers is disconnected from the network when canceling the Stereo Pair, cancel Stereo Pair on each speaker.

# UPDATING THE FIRMWARE

You can update the firmware only when the unit is connected to the Internet (☞ P.6).

Follow the instructions in the MusicCast CONTROLLER app to update.

While the firmware is being updated, the indicators flashes from the left in order, in accordance with the progress.

## Indicator display



Flashes from the left in order

Updating completed: All indicators light, and the unit automatically enters standby mode.

Updating failed: All the indicators flash. Unplug the power cable from the wall outlet and plug it in after 30 seconds or more, then update the firmware again.

### Note

- Do not operate the unit or disconnect the power cable or network cables while updating.
- Do not turn off the unit (enter standby) while updating the firmware.



- The update of the firmware will be informed in the app.
- When Internet speed is not fast enough or the unit is connected to the wireless network via a wireless network adapter, network update may not be possible depending on the condition of the wireless connection.

# OPTION SETTINGS

To set the unit to option setting mode, where you can make the following settings, set the unit to standby, and then touch and hold and for 5 seconds.

Items	Operations
<b>Initialize the unit.</b>	Touch and hold  (power)/CONNECT for 3 seconds (☞ P.3). During initialization, the three indicators flash for about 20 seconds.
<b>Enable/disable Network Standby.*2</b>	Touch and hold  for 3 seconds. Network Standby will be disabled. To enable it, perform the same operation. Enable: The power indicator flashes twice and remains lit. Disable: The power indicator flashes twice and turns off.
<b>Disable Wi-Fi.</b>	Touch and hold  for 3 seconds. Wi-Fi will be disabled. The Wi-Fi indicator flashes twice and turns off. To enable the Wi-Fi function, follow the procedures in “Connecting to the network“ (☞ P.6) and reconnect the unit to the network.
<b>Enable/Disable Bluetooth.</b>	Touch and hold  for 3 seconds. Bluetooth will be disabled. To enable it, perform the same operation. Enable: The Bluetooth indicator flashes twice and remains lit. Disable: The Bluetooth indicator flashes twice and turns off.

\*1: If you do not tap any button during these 10 seconds, the unit will cancel the option setting mode.

\*2: Network Standby is a standby which enables the unit to connect to the network by operating another device.



## Eco Standby

If you disable Network Standby, the unit enters a standby where indicators and the network/Bluetooth functions are disabled and where the standby power consumption is kept to a minimum.

While the unit is in Eco Standby, you cannot start it up with the MusicCast CONTROLLER app or specify stereo pair settings. Perform these operations after turning on the unit by tapping (power)/CONNECT.

## ADDITIONAL INFORMATION

### ■ DLNA

#### What types of servers can I use to browse or play back music files with DLNA?

Use a DLNA-compatible server, such as one of the following devices.

##### PC compatible with Windows Media Player 12 or Windows Media Player 11

To browse folders (directories) on your PC from this unit, you need to change the media sharing setting of Windows Media Player 12 or Windows Media Player 11 to make those folders accessible from this unit. For details on Windows Media Player, please ask Microsoft Corporation.

### ■ iTunes

#### Can I play back music in the iTunes library on WX-010?

Use AirPlay (☞ P.11).

### ■ Internet radio

#### Can I add other Internet radio stations to the list?

On the “vTuner Internet Radio” website, you can add Internet radio stations which do not exist on the list manually.

To use this feature, access the following URL to get a new account.

<http://yradio.vtuner.com/>

To create a necessary account for registration, you need the vTuner ID of this unit and your e-mail address (☞ P.10).

#### Can I delete Internet radio stations that I do not listen to from the list?

You cannot delete the vTuner list itself.

You can delete radio stations that you added by accessing the “vTuner Internet Radio” website.

## TRADEMARKS



MusicCast is a trademark or registered trademark of Yamaha Corporation.



The *Bluetooth*® word mark and logos are registered trademarks owned by *Bluetooth* SIG, Inc. and any use of such marks by Yamaha Corporation is under license.

#### **Bluetooth protocol stack (Blue SDK)**

Copyright 1999-2014 OpenSynergy GmbH  
All rights reserved. All unpublished rights reserved.



DLNA™ and DLNA CERTIFIED™ are trademarks or registered trademarks of Digital Living Network Alliance. All rights reserved. Unauthorized use is strictly prohibited.

### Windows™

Windows is a registered trademark of Microsoft Corporation in the United States and other countries.

Internet Explorer, Windows Media Audio and Windows Media Player are either registered trademarks or trademarks of Microsoft Corporation in the United States and/or other countries.

### Android™ Google Play™

Android and Google Play are trademarks of Google Inc.



The Wi-Fi CERTIFIED Logo is a certification mark of the Wi-Fi Alliance.

#### **Explanations regarding GPL**

This product utilizes GPL/LGPL open-source software in some sections. You have the right to obtain, duplicate, modify, and redistribute this open-source code only. For information on GPL/LGPL open source software, how to obtain it, and the GPL/LGPL license, refer to the Yamaha Corporation website (<http://download.yamaha.com/sourcecodes/musiccast/>).



AirPlay, iPad, iPhone, iPod, and iPod touch are trademarks of Apple Inc., registered in the U.S. and other countries.

iPad Air and iPad mini are trademarks of Apple Inc.

App Store is a service mark of Apple Inc.

# TROUBLESHOOTING

Refer to the table below when the unit does not function properly. If your problem is not listed below or if the instruction below does not help, turn off the unit, disconnect the power cable, and contact the nearest authorized Yamaha dealer or service center.

## General

Problem	Cause	Solution
<b>The unit is not turned on, or the touch sensors do not react.</b>	Your finger was touching the touch sensor on the top while the unit was starting up (the unit is adjusting the touch sensor sensitivity while the unit is starting up for about 10 seconds after you plugged the power cable into the wall outlet).	While the unit is starting up, wait and avoid touching the sensors until the unit has completely started up. Tap  <b>(power)/CONNECT</b> after the unit has completely started up (☞ P.3).
<b>The unit is turned off as soon as the unit is turned on. The unit does not operate properly.</b>	The power cable is not properly connected.	Connect the power cable firmly.
<b>This unit cannot be operated.</b>	The internal microcomputer has frozen, due to an external electric shock (such as lightning or excessive static electricity) or to a drop in the power supply voltage.	Unplug the power cable from the wall outlet and plug it again after 30 seconds or more.
<b>No sound.</b>	No appropriate source has been selected.	Select the music source that you want to play using the MusicCast CONTROLLER app (☞ P.7).
	The volume is minimum or mute.	Turn up the volume.
<b>There is noise interference from digital or high-frequency equipment.</b>	This unit is too close to the digital or high-frequency equipment.	Place this unit farther away from such equipment.

## MusicCast

Problem	Cause	Solution
<b>Cannot make the connection settings on the MusicCast CONTROLLER app.</b>	The mobile device is not connected to the wireless router at your home.	Connect the mobile device to the wireless router and start the MusicCast CONTROLLER app.
		Disable the cellular data transmission.
	The unit is turned off.	Turn on the unit.

## Network

Problem	Cause	Solution
<b>This unit is not detected with the MusicCast CONTROLLER app on your mobile device.</b>	The unit and mobile devices are not in the same network.	Check the network connections and your router settings, and then connect the unit and mobile device to the same network.
	Your mobile device is connected to the secondary SSID of a router supporting multi SSID.	When your mobile device is connected to the secondary SSID, access to the device connecting to the primary SSID or LAN is restricted (only Internet access is available). Connect your mobile device to the primary SSID.
	Multiple routers are connected between your connecting devices (double router).	Disconnect Internet temporarily, check the local network, and connect the connecting device you wish to use to the same router.
<b>The network feature does not function.</b>	The network parameters (IP address) have not been obtained properly.	Enable the DHCP server function on the router.
	The unit is starting up. (The unit becomes operative about 10 seconds after plugging the power cable into the wall outlet.)	Use the network function after the unit has completely started up.

Problem	Cause	Solution
<b>Playback stops (songs cannot be played back continuously).</b>	There are unsupported files in the server.	Remove the files (including image files or hidden files) which the unit does not support, from the folder being played back.
<b>A PC is not detected with the MusicCast CONTROLLER app on your mobile device.</b>	The media sharing setting is not correct.	Configure the sharing setting and select the unit as a device to which music contents are shared (P.10).
	Some security software installed on your PC is blocking the access of the unit to your PC.	Check the settings of security software installed on your PC.
	The unit and PC are not in the same network.	Check the network connections and your router settings, and then connect the unit and the PC to the same network.
	Your PC is connected to the secondary SSID of a router supporting multi SSID.	When your PC is connected to the secondary SSID, access to the device connecting to the primary SSID or LAN is restricted (only Internet access is available). Connect your PC to the primary SSID.
	Multiple routers are connected between your connecting devices (double router).	Disconnect Internet temporarily, check the local network, and connect the connecting devices you wish to use to the same router.
<b>The Internet radio cannot be played.</b>	The selected Internet radio station is currently not available.	There may be a network problem at the radio station, or the service may have been stopped. Try the station later or select another station.
	The selected Internet radio station is currently broadcasting silence.	Some Internet radio stations broadcast silence at certain of times of the day. Try the station later or select another station.
	Access to the network is restricted by the firewall settings of your connecting devices (such as the router).	Check the firewall settings of your connecting devices. The Internet radio can be played only when it passes through the port designated by each radio station. The port number varies depending on the radio station.
<b>Update of the firmware via network failed.</b>	The network connection is unstable.	Try updating again after a while.
<b>The unit cannot connect to the Internet via a wireless router (access point).</b>	The wireless router (access point) is turned off.	Turn on the wireless router.
	The unit and the wireless router (access point) are too far apart.	Place the unit and the wireless router (access point) closer to each other (P.6).
	There is an obstacle between the unit and the wireless router (access point).	Move the unit and the wireless router (access point) in a location where there are no obstacles between them (P.6).
<b>A wireless network is not detected with MusicCast CONTROLLER app on your mobile device.</b>	Microwave ovens or other wireless devices in your neighborhood might disturb the wireless communication.	Turn off these devices.
	Access to the network is restricted by the firewall settings of the wireless router (access point).	Check the firewall setting of the wireless router (access point).
<b>The iPhone does not recognize the unit when using AirPlay.</b>	The unit is connected to a multiple SSID router.	Access to the unit might be restricted by the network separation function on the router. Connect the iPhone to the SSID which can access the unit.



## Bluetooth

Problem	Cause	Solution
<b>Cannot make this unit paired with the connecting device.</b>	The connecting device does not support A2DP.	Perform pairing operations with a device which supports A2DP.
	The passkey of the devices, such as a <i>Bluetooth</i> adaptor, that you want to pair with this unit is other than "0000."	Use a connecting device with a passkey "0000."
	This unit and the connecting device are too far apart.	Move the connecting device closer to this unit.
	There is a device (microwave oven, wireless network, etc.) that outputs signals in the 2.4 GHz frequency band nearby.	Move this unit away from the device that is emitting radio-frequency signals.
	The unit is in standby.	Turn the unit on and perform pairing (☞ P.12).
	Another <i>Bluetooth</i> device is connected.	Terminate current <i>Bluetooth</i> connection, and perform pairing with the new device.
	The <i>Bluetooth</i> function of the unit is disabled.	Enable the <i>Bluetooth</i> function of the unit (☞ P.16).
<b>Cannot establish a <i>Bluetooth</i> connection.</b>	This unit is not registered on the connecting device's <i>Bluetooth</i> connection list.	Perform pairing operations again (☞ P.12).
	The unit is in Eco Standby.	Turn the unit on, then establish a <i>Bluetooth</i> connection (☞ P.12).
	Another <i>Bluetooth</i> device is connected.	Terminate current <i>Bluetooth</i> connection, then establish a <i>Bluetooth</i> connection with that device again.
	The <i>Bluetooth</i> function of the device is turned off.	Turn on the <i>Bluetooth</i> function of the device.
	The pairing information has been deleted.	Delete any pairing history of WX-010 on the <i>Bluetooth</i> device, then pair with the WX-010 again (☞ P.12).
<b>No sound is produced or the sound is interrupted during playback.</b>	The <i>Bluetooth</i> connection of this unit with the connecting device is disconnected.	Perform <i>Bluetooth</i> connection operations again (☞ P.12).
	This unit and the connecting device are too far apart.	Move the connecting device closer to this unit.
	There is a device (microwave oven, wireless network, etc.) that outputs signals in the 2.4 GHz frequency band nearby.	Move this unit away from the device that is emitting radio-frequency signals.
	The connecting device's <i>Bluetooth</i> function is off.	Turn on the <i>Bluetooth</i> function of the connecting device.
	The connecting device is not set to send <i>Bluetooth</i> audio signals to this unit.	Check that the <i>Bluetooth</i> function of the connecting device is set properly.
	The pairing setting of the connecting device is not set to this unit.	Set the pairing setting of the connecting device to this unit.
	The connecting device's volume is set to the minimum.	Increase the volume level.
	The connecting device is connected to more than two <i>Bluetooth</i> devices and this unit (WX-010) is not selected as a playback device.	Select this unit as a playback device for the connecting device.

# SUPPORTED DEVICES/MEDIA AND FILE FORMATS

## ■ File format

This unit supports the following formats.

File	Sampling frequency (kHz)	Quantization bitrate (bit)	Bitrate	The number of channels	Gapless playback
WAV (PCM format only)	32/44.1/48/88.2/96/ 176.4/192	16/24	—	2	✓
MP3	32/44.1/48	—	up to 320 kbps	2	—
WMA	32/44.1/48	—	up to 320 kbps	2	—
MPEG-4 AAC	32/44.1/48	—	up to 320 kbps	2	—
FLAC	32/44.1/48/88.2/96/ 176.4/192	16/24	—	2	✓
ALAC	32/44.1/48/88.2/96	16/24	—	2	✓
AIFF	32/44.1/48/88.2/96/ 176.4/192	16/24	—	2	✓

- To play back FLAC files, you need to install server software that supports sharing of FLAC files via DLNA on your PC or use a NAS that supports FLAC files.
- Digital Rights Management (DRM) contents cannot be played back.

## ■ PC

A PC with the following software installed.

- Windows Media Player 11/Windows Media Player 12

## ■ NAS

NAS that is compatible with DLNA version 1.5.

## ■ AirPlay

Supports iOS 7 or later for setup using Wireless Accessory Configuration.

AirPlay works with iPhone, iPad, and iPod touch with iOS 4.3.3 or later, Mac with OS X Mountain Lion or later, and PC with iTunes 10.2.2 or later.

(as of July 2016)

---

## Bluetooth

Bluetooth is a technology for wireless communication employing the 2.4 GHz frequency band, which can be used without a license.

### Handling Bluetooth communications

- The 2.4 GHz band used by Bluetooth compatible devices is a radio band shared by many types of equipment. While Bluetooth compatible devices use a technology minimizing the influence of other components using the same radio band, such influence may reduce the speed or distance of communications and in some cases interrupt communications.
- The speed of signal transfer and the distance at which communications is possible differs according to the distance between the communicating devices, the presence of obstacles, radio wave conditions and type of equipment.
- Yamaha does not guarantee all wireless connections between the sound bar and devices compatible with Bluetooth function.

# SPECIFICATIONS

## ■ PLAYER

### Network

- Ethernet interface ..... 100Base-TX/10Base-T
- Internet radio ..... vTuner service supported
- PC client function..... DLNA Ver. 1.5 (DMR function) supported
- Supported file format
  - ..... WAV, FLAC, AIFF (192 KHz/24 bit)
  - ..... ALAC (96 KHz/24 bit)
  - ..... MP3, WMA, MPEG-4 AAC (48 KHz/-)
- AirPlay ..... AirPlay supported

### Wi-Fi

- Wireless LAN Standards ..... IEEE 802.11 b/g/n
- Radio frequency ..... 2.4 GHz
- Available security method
  - ..... WEP, WPA2-PSK (AES), Mixed Mode

### ■ Bluetooth

- *Bluetooth* version..... Ver.2.1+EDR
- Supported protocols..... A2DP, AVRCP
- Compatible CODEC
  - ..... Sink: SBC, AAC
  - ..... Source: SBC
- Operation mode ..... Sink or Source
- Wireless output..... *Bluetooth* Class 2
- Maximum communication distance
  - ..... 10 m (33 ft) (without obstructions)

## ■ GENERAL

- Power Voltage/Frequency (U.S.A. model) ..... AC 120 V, 60 Hz (Other models)..... AC 100-240 V, 50/60 Hz
- Power consumption ..... 8 W
- Standby power consumption
  - Network Standby off/*Bluetooth* standby off..... 0.2 W
  - Network Standby on/*Bluetooth* standby off
    - ..... a) Wired: 1.8 W
    - ..... b) Wireless (Wi-Fi): 2.0 W
  - Network Standby on/*Bluetooth* standby on
    - ..... a) Wired: 1.8 W
    - ..... b) Wireless (Wi-Fi): 2.0 W
- Weight..... 1.7 kg (3.7 lbs.)
- Dimensions (W × H × D) ..... 120 mm × 160 mm × 130 mm (4-3/4 inch × 6-1/4 inch × 5-1/8 inch)

The contents of this manual apply to the latest specifications as of the publishing date.

To obtain the latest manual, access the Yamaha website then download the manual file.

**Important Notice: Guarantee Information for customers in EEA\* and Switzerland****English**

For detailed guarantee information about this Yamaha product, and Pan-EEA\* and Switzerland warranty service, please either visit the website address below (Printable file is available at our website) or contact the Yamaha representative office for your country. \* EEA: European Economic Area

**Remarque importante: informations de garantie pour les clients de l'EEE et la Suisse****Français**

Pour des informations plus détaillées sur la garantie de ce produit Yamaha et sur le service de garantie applicable dans l'ensemble de l'EEE ainsi qu'en Suisse, consultez notre site Web à l'adresse ci-dessous (le fichier imprimable est disponible sur notre site Web) ou contactez directement Yamaha dans votre pays de résidence. \* EEE : Espace Economique Européen

**Wichtiger Hinweis: Garantie-Information für Kunden in der EWR\* und der Schweiz****Deutsch**

Für nähere Garantie-Information über dieses Produkt von Yamaha, sowie über den Pan-EWR\*- und Schweizer Garantieservice, besuchen Sie bitte entweder die folgend angegebene Internetadresse (eine druckfähige Version befindet sich auch auf unserer Webseite), oder wenden Sie sich an den für Ihr Land zuständigen Yamaha-Vertrieb. \*EWR: Europäischer Wirtschaftsraum

**Viktigt: Garantiinformation för kunder i EES-området\* och Schweiz****Svenska**

För detaljerad information om denna Yamahaprodukt samt garantiservice i hela EES-området\* och Schweiz kan du antingen besöka nedanstående webbadress (en utskriftsvänlig fil finns på webbplatsen) eller kontakta Yamahas officiella representant i ditt land. \* EES: Europeiska Ekonomiska Samarbetsområdet

**Avviso importante: informazioni sulla garanzia per i clienti residenti nell'EEA\* e in Svizzera****Italiano**

Per informazioni dettagliate sulla garanzia relativa a questo prodotto Yamaha e l'assistenza in garanzia nei paesi EEA\* e in Svizzera, potete consultare il sito Web all'indirizzo riportato di seguito (è disponibile il file in formato stampabile) oppure contattare l'ufficio di rappresentanza locale della Yamaha. \* EEA: Area Economica Europea

**Aviso importante: información sobre la garantía para los clientes del EEE\* y Suiza****Español**

Para una información detallada sobre este producto Yamaha y sobre el soporte de garantía en la zona EEE\* y Suiza, visite la dirección web que se incluye más abajo (la versión del archivo para imprimir esta disponible en nuestro sitio web) o póngase en contacto con el representante de Yamaha en su país. \* EEE: Espacio Económico Europeo

**Belangrijke mededeling: Garantie-informatie voor klanten in de EER\* en Zwitserland****Nederlands**

Voor gedetailleerde garantie-informatie over dit Yamaha-product en de garantiservice in heel de EER\* en Zwitserland, gaat u naar de onderstaande website (u vindt een afdrukbaar bestand op onze website) of neemt u contact op met de vertegenwoordiging van Yamaha in uw land. \* EER: Europese Economische Ruimte

<http://europe.yamaha.com/warranty/>

Manual Development Group  
© 2016 Yamaha Corporation

Published 07/2017 KS-B0

AV17-0054