

YAMAHA R-5

*Natural Sound AM/FM Stereo Synthesizer Receiver
Yamaha Original Computer Servo Locked Tuning System
16-Station Random-Access Programmable Station Memory
New Continuously Variable Loudness Control and Bass Extension Function*

CENTER

6/15/73 訂 CAUTION 追加

Thank you for purchasing the YAMAHA R-5 AM/FM stereo receiver.

OWNER'S MANUAL



CONTENTS

SAFETY INSTRUCTIONS	1/2
CAUTION	2
CONNECTION DIAGRAM	3
CONNECTIONS	4/5
FRONT PANEL PARTS AND FUNCTIONS	6/7
MULTIPATH INTERFERENCE	8
PREVIOUS-STATION MEMORY	8
LISTENING TO A PROGRAM SOURCE	9
TROUBLESHOOTING	10
SPECIFICATIONS	11

IMPORTANT

Please record the serial number of your unit in the space below.

Model: **R-5**

Serial No.:

The serial number is located on the rear of the unit.
Retain this Owner's Manual in a safe place for future reference.

WARNING

To prevent fire or shock hazard, do not expose this appliance to rain moisture.

SAFETY INSTRUCTIONS

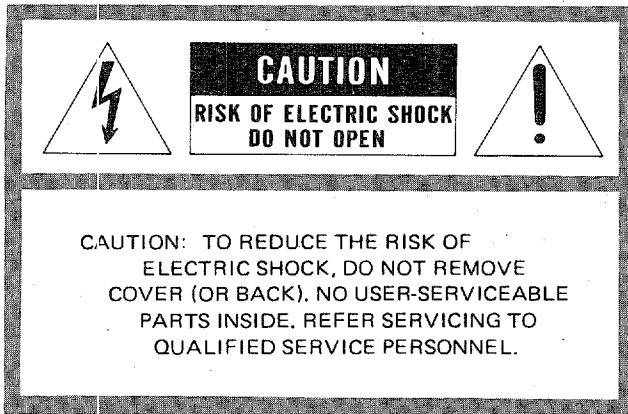

• Explanation of Graphical Symbols

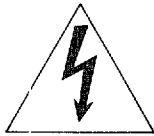

The lightning flash with arrowhead symbol, within an equilateral triangle, is intended to alert you to the presence of uninsulated "dangerous voltage" within the product's enclosure that may be of sufficient magnitude to constitute a risk of electric shock to persons.



The exclamation point within an equilateral triangle is intended to alert you to the presence of important operating and maintenance (servicing) instructions in the literature accompanying the appliance.

- 1** Read Instructions — All the safety and operating instructions should be read before the appliance is operated.
- 2** Retain Instructions — The safety and operating instructions should be retained for future reference.
- 3** Heed Warnings — All warnings on the appliance and in the operating instructions should be adhered to.
- 4** Follow Instructions — All operating and other instructions should be followed.
- 5** Water and Moisture — The appliance should not be used near water — for example, near a bathtub, washbowl, kitchen sink, laundry tub, in a wet basement, or near a swimming pool, etc.
- 6** Carts and Stands — The appliance should be used only with a cart or stand that is recommended by the manufacturer.
- 7** Wall or Ceiling Mounting — The appliance should be mounted to a wall or ceiling only as recommended by the manufacturer.
- 8** Ventilation — The appliance should be situated so that its location or position does not interfere with its proper ventilation. For example, the appliance should not be situated on a bed, sofa, rug, or similar surface that may block the ventilation openings; or placed in a built-in installation, such as a bookcase or cabinet that may impede the flow of air through the ventilation openings.
- 9** Heat — The appliance should be situated away from heat sources such as radiators, stoves, or other appliances that produce heat.
- 10** Power Sources — The appliance should be connected to a power supply only of the type described in the operating instructions or as marked on the appliance.
- 11** Power-Cord Protection — Power-supply cords should be routed so that they are not likely to be walked on or pinched by items placed upon or against them, paying particular attention to cords at plugs, convenience receptacles, and the point where they exit from the appliance.
- 12** Cleaning — The appliance should be cleaned only as recommended by the manufacturer.
- 13** Nonuse Periods — The power cord of the appliance should be unplugged from the outlet when left unused for a long period of time.
- 14** Object and Liquid Entry — Care should be taken so that objects do not fall into and liquids not spilled into the inside of the appliance.
- 15** Damage Requiring Service — The appliance should be serviced by qualified service personnel when:
 - A. The power-supply cord or the plug has been damaged; or
 - B. Objects have fallen, or liquid has been spilled into the appliance; or
 - C. The appliance has been exposed to rain; or
 - D. The appliance does not appear to operate normally or exhibits a marked change in performance; or
 - E. The appliance has been dropped, or the cabinet damaged.
- 16** Servicing — The user should not attempt to service the appliance beyond those means described in the operating instructions. All other servicing should be referred to qualified service personnel.
- 17** Power Lines — An outdoor antenna should be located away from power lines.
- 18** Grounding or Polarization — The precautions that should be taken so that the grounding or polarization means of an appliance is not defeated.

19 Outdoor Antenna Grounding — If an outside antenna is connected to the tuner, be sure the antenna system is grounded so as to provide some protection against voltage surges and built up static charges. Section 810 of the National Electrical Code, ANSI/NFPA

No. 70-1984, provides information with respect to proper grounding of the mast and supporting structure, grounding of the lead-in wire to an antenna discharge unit, size of grounding conductors, location of antenna-discharge unit, connection to grounding electrodes, and requirements for the grounding electrode.

EXAMPLE OF ANTENNA GROUNDING ACCORDING TO NATIONAL ELECTRICAL CODE INSTRUCTIONS (CONTAINED IN ARTICLE 810 — "RADIO AND TELEVISION EQUIPMENT")

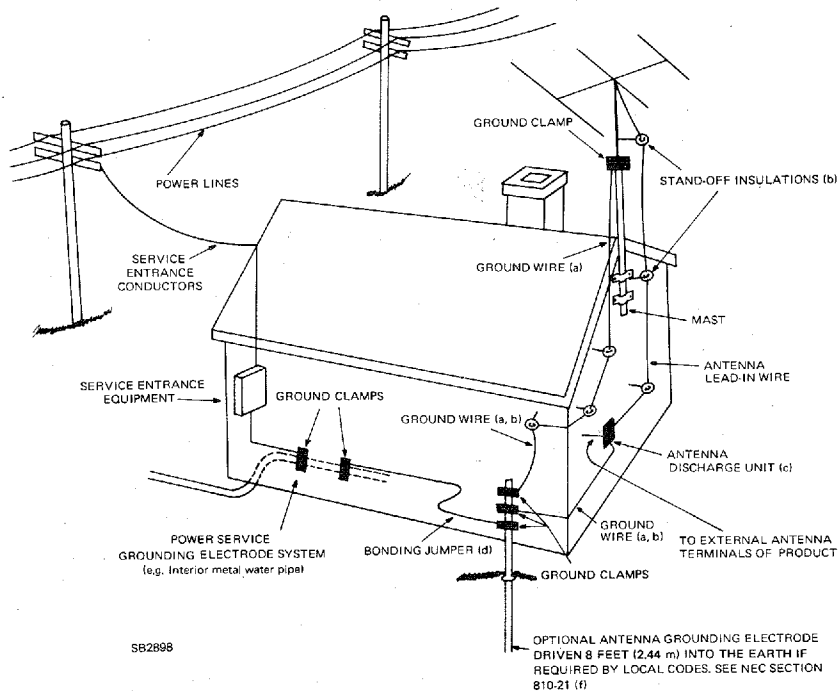

(a): Use No. 10 AWG (5.3mm²) copper, No. 8 AWG (8.4mm²) aluminium, No. 17 AWG (1.0mm²) copper-clad steel or bronze wire, or larger, as a ground wire.

(b): Secure antenna lead-in and ground wires to house with stand-off insulators spaced from 4 — 6 feet (1.22 — 1.83 m) apart.

(c): Mount antenna discharge unit as close as possible to where lead-in enters house.

(d): Use jumper wire not smaller than No. 6 AWG (13.3mm²) copper, or the equivalent when a separate antenna-grounding electrode is used. See NEC Section 810-21 (j).

CAUTION: READ THIS BEFORE OPERATING YOUR R-5

1 The R-5 is a sophisticated stereo receiver. To ensure proper operating for the best possible performance, please read this manual carefully.

2 Choose the installation of your R-5 carefully. Avoid placing it in direct sunlight or close to a source of heat. Also avoid locations subject to vibration and excessive dust, heat, cold or moisture. Keep away from such sources of hum as transformers or motors.

3 To ensure that the unit operates properly, be sure to set it on a level surface, and do not cover the heat vents on the top.

4 If speaker impedance is too low or the temperature becomes too high, a temperature protector cuts off the power. Wait for the unit to cool down or change the impedance, and the unit will operate normally.

5 Use only the supplied AM loop antenna in the AM antenna terminal.

6 The back-up power supply will keep the preset stations memorized for about three weeks if power fails or the set is unplugged. In order to keep the back-up power supply fully charged, turn the power switch on once a week even if you are not using the unit. Even if the preset stations are erased, the memory is still functional; merely preset the stations again.

7 Do not open the cabinet as this might result in damage to the set or electrical shock. If a foreign object should get into the set, contact your dealer.

8 Do not plug receiver so will cause result in a

9 When rem always pul

10 To prevent and remov storm.

11 Do not use

12 When mov plug and r

13 Always set the tonear after the s

14 Do not att as this mig

15 Do not cor the rear p than the o

16 Be sure to on commc your R-5 i

17 Keep this i

R-5

CONNECTION DIAGRAM

Be sure to connect the left (L) and right (R) channels consistently from component to component.

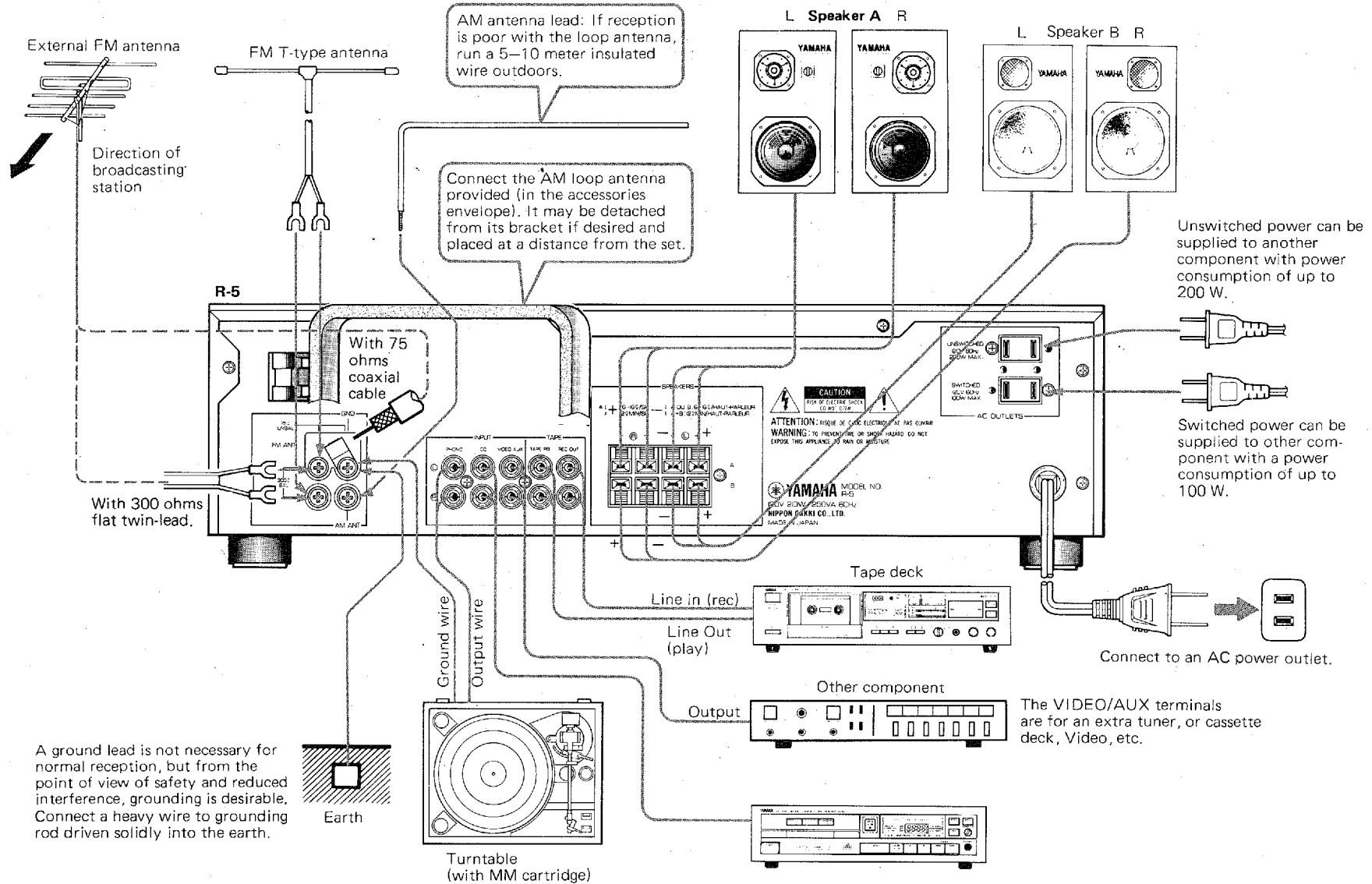

A ground lead is not necessary for normal reception, but from the point of view of safety and reduced interference, grounding is desirable. Connect a heavy wire to grounding rod driven solidly into the earth.

CONNECTIONS

■ CONNECTING THE SPEAKERS

1. Connect the cords going to the left speakers to the L terminals and the right speaker cords to the R terminals, making sure that the "+" and "-" markings are observed. If the "+" and "-" wires are reversed at either speaker, the sound will be unnatural and lack bass. Speaker cords should be cut as short as possible; do not coil up excess wire on the floor. Also, do not bundle with cords from other system components.
2. Push in on the lever at the terminal, insert the exposed wire of the speaker cord into the hole and then release the lever. The cord will be locked into position. If these connections are faulty, no sound will be heard from the speakers.
3. A second pair of speakers may be connected in the same way if desired. Use the speaker "B" terminals provided.

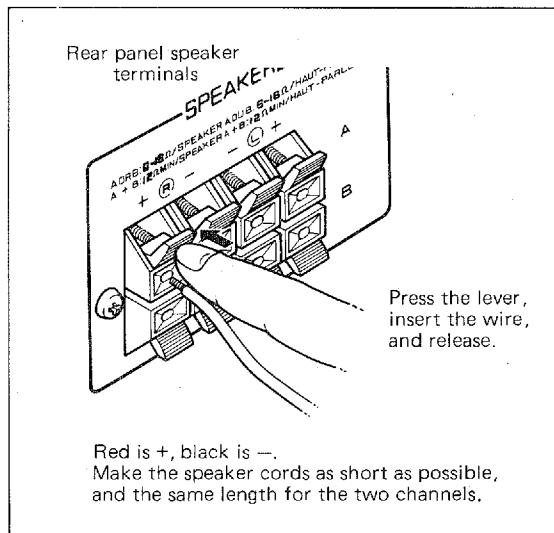

■ CONNECTING A TURNTABLE

Connect the output cords of the turntable to the amplifier's Phono jacks, and connect the ground wire to the Gnd terminal. Normally, connecting the ground wire produces minimum hum, but in some cases better results are obtained with the ground wire disconnected. The cartridge and the turntable's output cords should be positioned well away from such sources of hum as power cords or power transformers of other system components.

■ CONNECTING A TAPE DECK

Connect the Tape PB jacks to the tape deck's Line Out jacks, and the Rec Out jacks to the tape deck's Line In jacks.

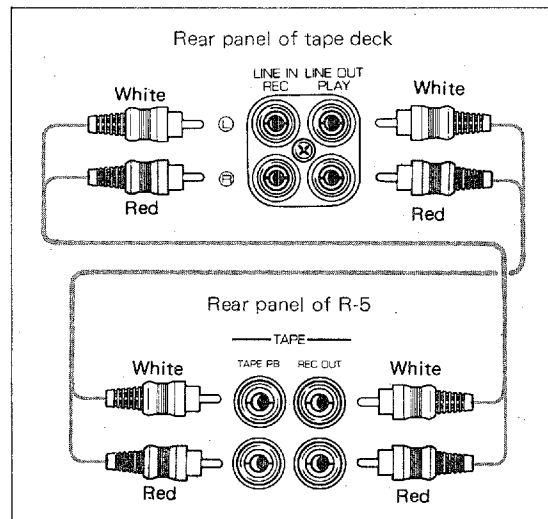

■ CONNECTING TO THE VIDEO/AUX AND CD JACKS

The VIDEO/AUX and CD jacks can be used for connecting additional equipment such as a second tuner, a compact disc player, etc. Note that a turntable cannot be connected to the VIDEO/AUX and CD jacks as there is no RIAA equalization.

■ CONNECTING THE AM ANTENNA

In many cases it will be possible to get excellent AM reception with the provided AM loop antenna. Attach the antenna leads to the Gnd and AM ANT terminals and rotate the antenna in its bracket for best reception. The loop antenna may also be removed and hung on the wall.

If necessary, an outdoor antenna may be used for improved AM reception. Connect a 5–10 meter length of insulated wire to the AM ANT terminal and run it outdoors.

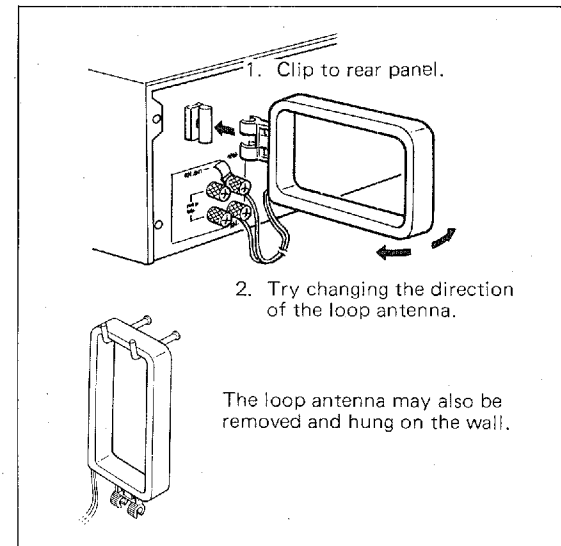

R-5

■ CONNECTING THE FM ANTENNA

Choose an FM antenna that is appropriate to the local reception conditions. Consider the distance from the broadcast station and possible interfering objects such as surrounding tall buildings. In cases where there is a strong signal from a local station, a portable T-type antenna is usually adequate. Connect the feeder wire to the 300Ω terminal, stretch the wire out tight, and turn to obtain optimum reception. Attach to a suitable support such as a wall.

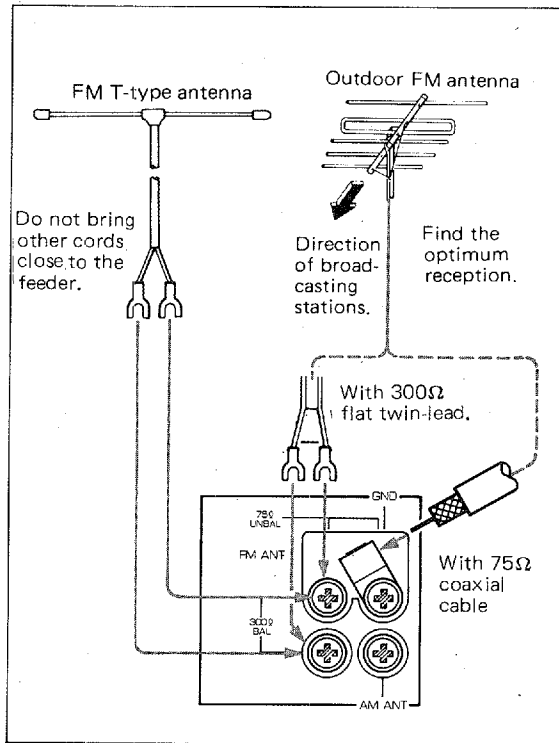

In all but the best reception conditions, an outdoor FM antenna is necessary for best results. Either 300Ω flat twin-lead wire or 75Ω coaxial cable may be used.

In locations where electrical interference is a problem, coaxial cable is preferable.

Note: Connect either an indoor FM T-type antenna or an outdoor FM antenna but not both.

- ① Strip outer sheath on coaxial cable to expose braid. Then cut off braid and leave it 10 mm in length.

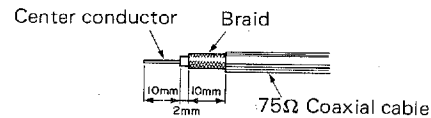

- ② Loosen the screws of the 75 Ohms and GND terminals, and loosen the clasper so it moves freely.

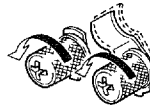

- ③ Insert the braid portion of the coaxial cable in the clasper, and connect the center conductor to the 75 Ohms terminal.

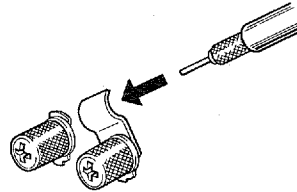

- ④ Tighten the screws of both terminals, and connect the coaxial cable.

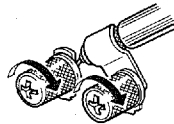

■ NOTE ON FM/AM ANTENNA INSTALLATION

This receiver has both an auto-search type tuning system with 100kHz steps on FM and 10kHz steps on AM and a manual tuning system. Normally, with stations stronger than 10μV (300μV/m on AM when using the loop antenna), auto-search tuning can be used to find and tune in stations automatically. Weaker stations may be tuned in with manual step tuning. Try rechecking the antenna connections and adjusting the location, direction, and height of the antenna to increase the signal strength to a high enough level for proper reception.

■ AC OUTLETS

Provided for connecting other equipment. The bottom outlet is switched on and off by the receiver's power switch and have a maximum combined capacity of 100W. The top outlet supplies continuous unswitched power up to maximum of 200W.

FRONT PANEL PARTS AND FUNCTIONS

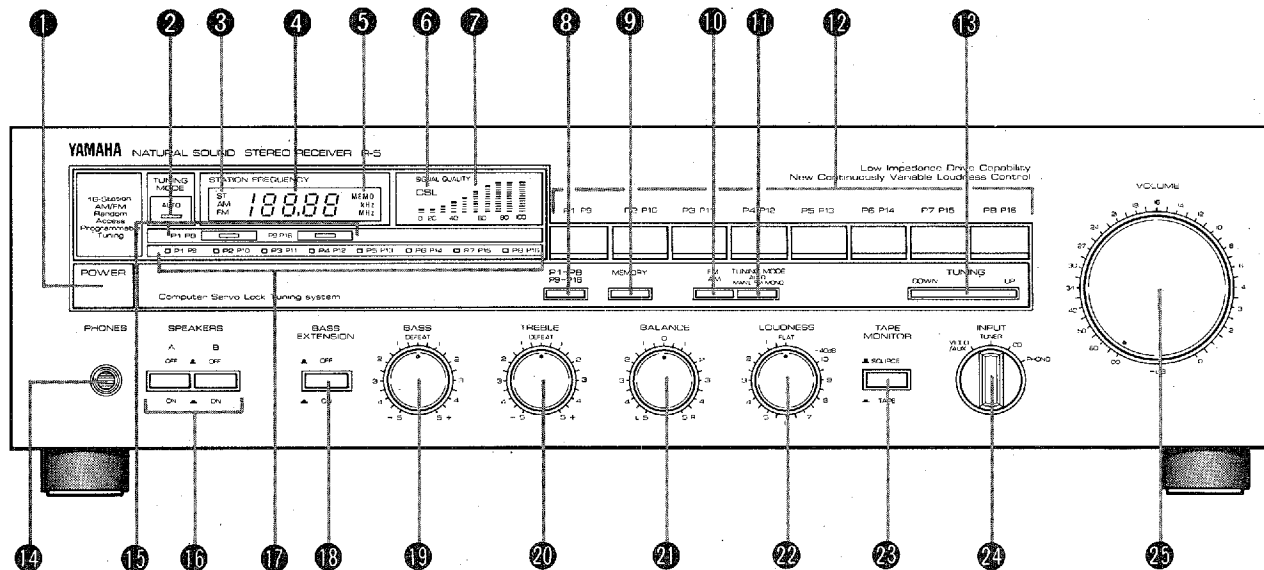
**1 POWER SWITCH**

This is a "push-on, push-off" type power switch. Turning the POWER switch on tunes in the frequency of the station selected before the Power switch was turned off and lights the corresponding indicators.

2 TUNING MODE INDICATOR

The AUTO indicator lights when the TUNING MODE key **11** is set to AUTO, and remains off when the TUNING MODE key is set to MAN'L.

3 ST INDICATOR

When an FM stereo broadcast is being received this indicator automatically lights.

4 DIGITAL FREQUENCY INDICATOR

This displays the frequency of the station tuned in with the TUNING key **10** or with the PRESET STATION buttons **12**. The display covers a range of 87.5–108.0 MHz on FM and 510–1620kHz on AM.

5 MEMORY INDICATOR

Pressing the memory key flickers this indicator for 5 seconds. During this interval memory presetting may be performed.

6 CSL (Computer Servo Lock) INDICATOR

This indicator lights up during tuning to show that the Computer Servo Lock synthesizer system has tuned in a station.

7 SIGNAL QUALITY INDICATOR

This indicator shows the strength of the received station. When tuning in a station, adjust the antenna's height and direction for maximum signal indication.

8 P1–P8 / P9–P16 SELECTION KEY

Each time this key is pressed, the preset station range will be switched between the P1 – P8 range and the P9 – P16 range.

9 MEMORY BUTTON

Use to preset station frequencies into the programmable memory. Pressing the button lights the Memory indicator for about 5 seconds. While the indicator is lit, press the numbered preset station button corresponding to the memory location it is desired to set. The frequency currently displayed will be set into the memory.

10 BAND SELECTOR

This selects either FM or AM broadcasts.

11 TUNING MODE SWITCH

• AUTO

The tuner is in auto-search tuning mode. Pressing Tuning key automatically tunes in the first station in the selected direction. Normally the switch should be left in this mode. FM muting is active while searching.

• MAN'L/FM MONO

The tuner is in manual tuning mode. In addition, FM muting is inactive, allowing extremely weak stations to be received. In this mode, even stereo stations will be received in mono. This is extremely useful to improve the reception quality of weak, noisy stereo stations.

12 PRESET STATION KEYS

Up to 16 preset stations (selectable between FM only: 16 stations; AM only: 16 stations; or FM and AM combined: 16 stations) can be programmed by using the PRESET STATION keys together with the P1-P8/P9-P16 SELECTION key.

When programming each preset, the station frequency and band mode (FM or AM) can be entered simultaneously into the memory. Thereafter, each station can be tuned in simply by lightly touching the proper PRESET STATION key.

13 TUNING KEY

Use this key to tune in broadcast stations.

• When the TUNING MODE key 11 has been set to AUTO.

Pressing the DOWN side of the key scans the broadcast band downwards until a station is encountered, then stops with the station perfectly tuned in (Auto-Search Tuning). Pushing the key again scans progressively lower frequencies until the next station is found. When the bottom of the band is reached, the frequency is set to the top of the band and the scan continues downward. Pressing the Up side of the key scans the band upwards in the same way.

• When the TUNING MODE key 11 has been set to MAN'L.

Pressing the DOWN side of the key scans down the band only as long as the key is held, and pressing the Up side scans upwards as long as the key is held. In either case scanning stops when the key is released. Pushing the Tuning key briefly causes the frequency to advance 100kHz on FM or 10kHz on AM.

14 PHONES JACK

Used for plugging in headphones. When it is desired to listen to headphones only, Speaker switches A and B should both be set to the Off () position.

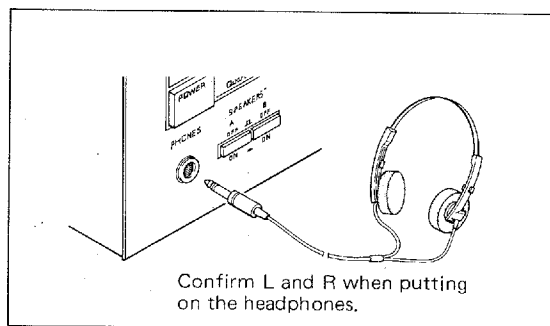

15 P1-P8/P9-P16 SELECTION INDICATORS

Pressing the P1-P8/P9-P16 SELECTION key will cause the appropriate indicator to flicker for about 5 seconds, after which the flickering will change to a steady glow, indicating the range has been selected. Pressing a PRESET STATION key while either indicator is flickering will cause the flickering to change to a steady glow, which means that the preset stations can be tuned in instantaneously.

16 SPEAKER SWITCHES

Allows you to select speaker system A, system B, or both at once. When listening to headphones only, turn both A and B off.

17 PRESET STATION INDICATOR

These rear-illuminated indicators will indicate the preset station selected. Pressing one of the PRESET STATION keys will cause its corresponding indicator to light up. (Although two stations will be indicated simultaneously by the upper and lower indicators respectively, the station indicated by the 15 indicator will be selected.)

18 BASS EXTENSION BUTTON

Pushing this button in boosts the bass range. Can be used to compensate for speakers with weak bass or for a listening environment which deadens the bass.

19 BASS CONTROL

Used to control the bass response, a flat response is obtained at the DEFEAT position. The bass effect is emphasized when the control is rotated to the right and attenuated when rotated to the left.

20 TREBLE CONTROL

Used to control the treble response. A flat response is obtained at the DEFEAT position. The treble effect is emphasized when the control is rotated to the right and attenuated when rotated to the left.

21 BALANCE CONTROL

This control lets you adjust the relative volume of the right and left speakers, enabling you to compensate for unbalance caused by the locations of the speakers and furniture arrangement.

22 LOUDNESS CONTROL

Compensates for our ear's reduced sensitivity to the extreme low and high frequencies at low volumes. Set it to the Flat position with the Volume control set to your loudest listening level. Rotate it to the left to reduce the volume while retaining the natural balance of the low and high frequencies.

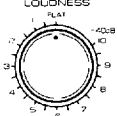
1 **LOUDNESS**
 Set Loudness to the Flat position and increase the Volume to loudest level desired.

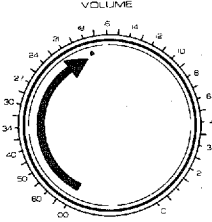
2 **VOLUME**
 Turn Loudness control knob counterclockwise to reduce the volume.

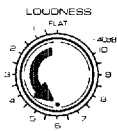
3 **LOUDNESS**
 Turn Loudness control knob counterclockwise to reduce the volume.

23 TAPE MONITOR BUTTON

Press this key to monitor the sound from a tape deck connected to the Tape PB jacks on the rear panel. Press it again to key off, and you can listen to the selected source.

24 INPUT SELECTOR

These select the program source to be listened to or recorded.

25 VOLUME CONTROL

Adjusts overall volume level. Level increases as the control is turned to the right.

* Before turning on power, changing the setting to function keys, or lowering the tonearm to the record, be sure to turn the volume all the way down.

MULTIPATH INTERFERENCE

Multipath is an effect similar to television ghosting; it distorts the received signal and also causes poor stereo separation and noise. As shown in fig. radio waves which travel directly from the transmitter to the receiving antenna are mixed with waves which reflect off nearby objects such as buildings. Because the path taken by the reflected waves is longer than the direct path, the time required for the waves to arrive at the antenna is also longer. The mixing of the directly received signal and the delayed signal noticeably degrades reception quality. Multipath interference can be greatly reduced by the use of a high-quality directional antenna oriented in the proper direction.

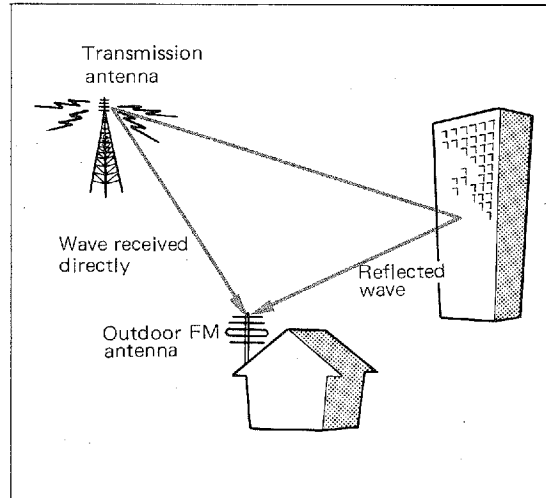

PREVIOUS-STATION MEMORY

- If power is turned off while a station is tuned in, the same station will be tuned in automatically when power is turned on again. Even if the power cord is pulled out rather than the power key being turned off, the effect is the same.
- When the reception band is changed from FM to AM, the last AM station listened to will automatically be tuned in again. In the same way, when reception band is changed from AM to FM, the last FM station will be tuned in again.
- * If the power is turned off or the Band selector is pressed while auto-search tuning is in progress, next time the power is turned on or the Band selector is pressed no station may be tuned in even though the frequency display is lit.

LISTENING TO A PROGRAM SOURCE

■ LISTENING TO FM BROADCASTS

1. Set the Input selector to Tuner.
2. Press the Band selector to select FM.
3. Set the Tuning Mode key to "Auto".
4. Press either the Up or the Down side of the Tuning key for 2 or 3 seconds. The receiver will automatically scan the FM band in the selected direction. When a station is found, the scan will stop and the station will be locked in automatically. Use the Tuning key repeatedly to tune in your desired station. Stations may also be selected with the preset tuning keys.
5. When the station is in stereo the ST indicator will light, while for mono stations the indicator will remain off.
 - When listening to a weak, distant station or when there is interference from another station, setting the Tuning Mode key to MAN'L/FM MONO position will cause the station to be received in mono and considerably reduce noise.
6. Adjust the volume, tone, balance, and loudness levels to your preference.

■ LISTENING TO AM BROADCASTS

1. Set the Input selector to Tuner.
2. Press the Band selector to select AM.
3. Press either the Up or the Down side of the Tuning key for 2 or 3 seconds. The receiver will automatically scan the AM band in the selected direction. When a station is found, the scan will stop and the station will be locked in automatically. Use the Tuning key repeatedly to tune in your desired station. Stations may also be selected with the preset tuning keys.
4. Adjust the volume, tone, balance, and loudness levels to your preference.

■ PRESET TUNING

In addition to the auto-search tuning feature, a convenient programmable preset tuning system allows you to tune in your favorite stations with the touch of a key. To preset a station into the memory, first tune the station in. After pressing the Memory key, press one of the numbered preset tuning keys. The tuner will then memorize the station's frequency. Any time the appropriate numbered key is pressed, the station will be automatically tuned in. After you have preset a station, it is a good idea to manually change to another frequency and then push the newly memorized station's key again to see that it is tuned in correctly. Up to 16 stations can be preset—16 AM, 16 FM, or any combination of AM and FM. The band is memorized together with the station. To tune in a previously memorized station, press the numbered key corresponding to the desired station. The station will be automatically tuned in. The preset tuning key will light to indicate automatic station selection.

There may be cases where static electricity or electrical noise from fluorescent lamps or television sets prevents successful preset tuning. Set the tuner away from such sources of interference.

■ LISTENING TO RECORDS

1. Set the Input selector to Phono.
2. If your turntable is equipped with an MM cartridge it can be connected directly to the receiver. But if an MC cartridge is used an MC cartridge head amp or a step-up transformer will be necessary.
3. Place a record on the Platter and start it playing.
4. Adjust the volume, tone, balance, and loudness levels to your preference.
 - When lowering the stylus to the record or raising the stylus from the record, turn the volume control all the way to "∞".

■ RECORDING TAPES

1. Select the source to be recorded (Phono, Video/Aux, CD or Tuner) with the input selector.
2. Start the music from the selected source.
3. Set the recording level, etc. of the tape deck, and begin recording.
4. Pushing the Tape Monitor key will allow you to monitor the recording sound.
 - Adjusting the tone controls (Bass, Treble) or the volume control during recording has no effect on the material being recorded.

■ PLAYING BACK TAPES

1. Push the Tape Monitor key.
2. Set the tape deck to Play.
3. Adjust the volume, tone, balance, and loudness levels to your preference.

■ PLAYING BACK CDS OR Video/Aux

1. Set the input selector to CD or Video/Aux.
2. Set the Compact Disc Player, Video Disc Player or auxiliary appliance.
3. Adjust the volume, tone, balance, and loudness levels to your preference.

TROUBLESHOOTING

Before assuming that your receiver is faulty, check following the troubleshooting list which details the corrective action you can take yourself without having to call a service engineer. If you have any doubts or questions, get in touch with your nearest Yamaha dealer.

	FAULT	CAUSE	CURE
AUDIO	Power is not applied even though the Power switch is turned on.	The power cord is not plugged in.	Plug in the power cord.
	There is no sound with any position of the Input selector.	The Speaker keys are not set correctly.	Set them correctly.
		The input cords are not connected securely.	Plug them in securely.
	There is no sound from one speaker.	The speaker connections are not secure.	Secure the connections.
		The Balance control is set all the way to the left or right.	Adjust the Balance control correctly.
	There is a lack of bass and no ambience.	The + and - cords have been reversed at the amp or the speakers.	Connect the speaker wires in the correct phase (+ and -).
	There is a humming sound when playing records.	The input cords are not connected securely.	Plug the input cords in securely.
The turntable's ground wire is not connected.		Connect the ground wire.	
FM	Crackling sounds from time to time (especially in weak signal areas).	Ignition noise from vehicles.	The FM antenna should be put up as high as possible, away from the road, and a coaxial cable used.
		Noise from thermostats and other electrical equipment.	Attach a noise suppressor to the equipment causing the noise.
	FM stereo reception is noisy.	Because of the characteristics of FM stereo broadcasts, this is limited to cases where the transmitter is far away or the antenna input is poor.	Check the antenna connections.
			Try using a multiple element FM antenna.
			Set the Tuning Mode key to the MAN'L position.
	The FM Stereo indicator flickers on and off and reception is noisy.	Insufficient antenna input.	Use an antenna appropriate for the reception conditions in your area.
			Not tuned correctly.
	There is distortion and clear reception cannot be obtained even with a good FM antenna.	There is multipath interference.	Adjust antenna placement to eliminate multipath interference.
	No stereo effect even with a stereo broadcast.	The Tuning Mode switch is set to MAN'L.	Set this key to the Auto position.
	A desired station can not be tuned in with Auto Tuning.	The station is too weak.	Use a high-quality directional FM antenna.
	Previously preset stations can no longer be tuned in.	The tuner has been unplugged for a long period.	Repeat the preset procedure.
	AM	Insufficient sensitivity.	Weak signal or loose antenna connections.
Use an outdoor antenna.			
There are continuous crackling and hissing noises.		These noises result from lightning, fluorescent lamps, motors, thermostats and other electrical equipment.	Use an outdoor antenna and a ground wire. This will help somewhat but it is difficult to eliminate all noise.
	Another station is interfering with the received station.		This is impossible to remedy.
There are buzzing and whining noises.	A television set is being used nearby.	Move the television a distance away.	

R-5

SPECIFICATIONS

AUDIO SECTION

Minimum RMS Output Power per Channel

8 ohms, 20 Hz to 20 kHz, 0.015% THD	50 W
6 ohms, 20 Hz ~ 20 kHz, 0.05% THD	55 W

Dynamic Headroom

(IHF, 8 ohms)	1.76 dB
---------------	---------

Power Bandwidth

8 ohms, 0.1% THD, Half Rated Power	10 Hz to 50 kHz
---------------------------------------	-----------------

Damping Factor

(8 ohms, 1 kHz)	50
-----------------	----

Input Sensitivity/Impedance

Phono	2.5 mV/47 k-ohms
CD/Tape/Video	150 mV/50 k-ohms

Input Sensitivity (New IHF)

Phono	0.42 mV
CD/Tape/Video	25 mV

Maximum Input Level

(1 kHz, 0.01% THD) Phono	120 mV
-----------------------------	--------

Output Level/Impedance

Rec Out	150 mV/1.5 k-ohm
---------	------------------

Headphone Output/Impedance

(0.015% THD, 8 ohms)	0.7 V/220 ohms
----------------------	----------------

Frequency Response

CD/Tape/Video (20 Hz to 20 kHz)	±0.5 dB
------------------------------------	---------

RIAA Deviation

Phono	±0.5 dB
-------	---------

Total Harmonic Distortion (20 Hz to 20 kHz)

Phono to Rec Out (3 V)	0.01%
CD/Tape/Video to Sp Out (25 W/8 ohms)	0.015%

Intermodulation Distortion

CD/Tape/Video (Rated Power/8 ohms)	0.01%
---------------------------------------	-------

Signal-to-Noise Ratio (IHF A Network)

Phono (5 mV, Input Shorted)	88 dB
CD/Tape/Video (AM position, Input Shorted)	103 dB

Signal-to-Noise Ratio (New IHF)

Phono	74 dB
CD/Tape/Video (AM Position)	84 dB

Residual Noise (IHF A Network)

(IHF A Network)	110 μ V
-----------------	-------------

Channel Separation (1 kHz)

Phono (Input Shorted)	55 dB
CD/Tape (5.1 k-ohms Shorted)	52 dB

Tone Control Characteristics

Bass (boost/cut)	±10 dB (50 Hz)
Treble (boost/cut)	±10 dB (20 kHz)

Filter Characteristics

Bass Extension	+8 dB (60 Hz)
----------------	---------------

Continuous Loudness Control

(Level-Related Equalization) Max. Attenuation	-40 dB at 1 kHz
--	-----------------

FM SECTION

Tuning Range

	87.5 to 108.0 MHz
--	-------------------

50 dB Quieting Sensitivity (IHF, 75 ohms)

Mono	1.55 μ V (15.1 dBf)
Stereo	21 μ V (37.7 dBf)

Usable Sensitivity

(30 dB Quieting, 75-ohms, Mono)	0.8 μ V (9.3 dBf)
------------------------------------	-----------------------

Image Response Ratio

	40 dB
--	-------

IF Response Ratio

	90 dB
--	-------

Spurious Response Ratio

	70 dB
--	-------

AM Suppression Ratio

	55 dB
--	-------

Capture Ratio

	1.5 dB
--	--------

Alternate Channel Selectivity

(IHF)	55 dB
-------	-------

Signal-to-Noise Ratio (IHF)

Mono	85 dB
Stereo	81 dB

Harmonic Distortion

Mono 1 kHz	0.07%
Stereo 1 kHz	0.1%

Stereo Separation (IHF)

1 kHz	50 dB
-------	-------

Frequency Response

30 Hz to 13 kHz	0 ±0.5dB
-----------------	----------

AM SECTION

Tuning Range

	510 kHz to 1,620 kHz
--	----------------------

Usable Sensitivity

	250 μ V/m
--	---------------

Selectivity

	24 dB
--	-------

Signal-to-Noise Ratio

	50 dB
--	-------

Image Response Ratio

	40 dB
--	-------

Spurious Response Ratio

	50 dB
--	-------

Distortion (400 Hz)

	0.3%
--	------

Output Level/Impedance (REC OUT)

FM 100% mod. 1 kHz	500 mV/2.8 k-ohms
AM 30% mod. 400 Hz	150 mV/2.8 k-ohms

GENERAL

Power Supply

	120 V/60 Hz
--	-------------

Power Consumption

	210 W
--	-------

AC Outlet

Switched	100 W max.
Unswitched	200 W max.

Dimensions (W x H x D)

	435 x 126 x 289 mm (17-1/8" x 4-15/16" x 11-3/8")
--	---

Weight

	5.6 kg (12.3 lbs.)
--	--------------------

Specifications subject to change without notice.

SINCE 1887



YAMAHA

NIPPON GAKKI CO., LTD. HAMAMATSU, JAPAN

CA08117-2 BWgb,Y Printed in Japan