

YAMAHA DSP-A590

Natural Sound Digital Sound Field Processing Amplifier

Amplificateur de champ sonore numérique de la série “Natural Sound”

Natural Sound Digitaler Klangfeldverstärker

Digital ljudfältförstärkare med naturligt ljud

Amplificatore digitale a suono naturale per l’elaborazione del campo sonoro

Amplificador de procesamiento de campo de sonido digital de Sonido natural

Digitale geluidsveldprocessing-versterker met natuurlijke klank

OWNER’S MANUAL
MODE D’EMPLOI
BEDIENUNGSANLEITUNG
BRUKSANVISNING
MANUALE DI ISTRUZIONI
MANUAL DE INSTRUCCIONES
GEBRUIKSAANWIJZING

SUPPLIED ACCESSORIES
ACCESSOIRES FOURNIS
MITGELIEFERTE ZUBEHÖRTEILE
MEDFÖLJANDE TILLBEHÖR
ACCESSORI IN DOTAZIONE
ACCESORIOS INCLUIDOS
BIJGELEVERDE ACCESSOIRES

- After unpacking, check that the following parts are included.
- Après le déballage, vérifier que les pièces suivantes sont incluses.
- Nach dem Auspacken überprüfen, ob die folgenden Teile vorhanden sind.
- Kontrollera efter det apparaten packats upp att följande delar finns med.
- Verificare che tutte le parti seguenti siano contenute nell'imballaggio dell'apparecchio.
- Desembale el aparato y verificar que los siguientes accesorios están en la caja.
- Controleer na het uitpakken of de volgende onderdelen voorhanden zijn.

- Remote Control Transmitter
- Emetteur de télécommande
- Fernbedienungsgeber
- Fjärrkontrollsändare
- Telecomando
- Transmisor del control remoto
- Afstandbediening

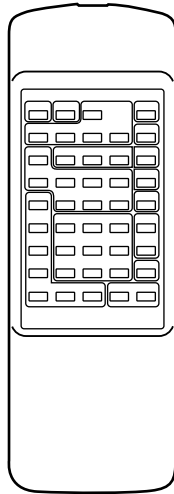

- Batteries (size AA, R6, UM-3)
- Piles (taille AA, R6, UM-3)
- Batterien (Größe AA, R6, UM-3)
- Batterier (storlek AA, R6, UM-3)
- Batterie (dimensioni AA, R6, UM-3)
- Pilas (tamaño AA, R6, UM-3)
- Batterijen (maat AA, R6, UM-3)

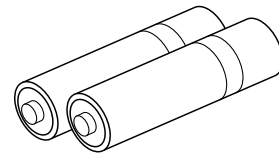

This product complies with the radio frequency interference requirements of the Council Directive 82/499/EEC and/or 87/308/EEC.

Cet appareil est conforme aux prescriptions de la directive communautaire 87/308/CEE.

Diese Geräte entsprechen der EG-Richtlinie 82/499/EWG und/oder 87/308/EWG.

Dette apparat overholder det gældende EF-direktiv vedrørende radiostøj.

Questo apparecchio è conforme al D.M.13 aprile 1989 (Direttiva CEE/87/308) sulla soppressione dei radiodisturbi.

Este producto está de acuerdo con los requisitos sobre interferencias de radio frecuencia fijados por el Consejo Directivo 87/308 CEE.

Dit product voldoet aan de EEG normen betreffende radio-frekventie storingen 82/499/EEG en/of 87/308/EEG.

FEATURES

- **5 Speaker Configuration**
 - Front: 70W + 70W (8Ω) RMS Output Power, 0.04% THD, 20–20,000 Hz
 - Center: 70W (8Ω) RMS Output Power, 0,07% THD, 20–20,000 Hz
 - Rear: 20W + 20W (8Ω) RMS Output Power, 0.3% THD, 1 kHz
- **Digital Sound Field Processor**
 - 6 Programs for Digital Sound Field Processing
 - 2 Programs for Dolby Surround Decoding (DOLBY PRO LOGIC and DOLBY PRO LOGIC ENHANCED)
- **Automatic Input Balance Control for Dolby Surround**
- **Test Tone Generator for Easier Speaker Output Balance Adjustment**
- **3 Center Channel Modes (NORMAL/WIDE/PHANTOM)**
- **Video Signal Input/Output Capability (Including S Video Connections)**
- **SLEEP Timer**
- **Remote Control Capability**

CONTENTS

Supplied Accessories	2	Using Digital Sound Field Processor (DSP) ..	18
Caution	4	Setting the SLEEP Timer	22
Profile of This Unit	5	Remote Control Transmitter	23
Speaker Setup for This Unit	6	Notes about the Remote Control Transmitter	24
Connections	7	Troubleshooting	25
Speaker Balance Adjustment	12	Specifications	26
Basic Operations	15		

CAUTION : READ THIS BEFORE OPERATING YOUR UNIT.

1. To assure the finest performance, please read this manual carefully. Keep it in a safe place for future reference.
2. Install this unit in a cool, dry, clean place – away from windows, heat sources, sources of excessive vibration, dust, moisture and cold. Avoid sources of humming (transformers, motors). To prevent fire or electrical shock, do not expose the unit to rain or water.
3. Never open the cabinet. If something drops into the set, contact your dealer.
4. Do not use force on switches, controls or connection wires. When moving the unit, first disconnect the power plug and the wires connected to other equipment. Never pull the wires themselves.
5. The openings on the cabinet assure proper ventilation of the unit. If these openings are obstructed, the temperature inside the cabinet will rise rapidly and eventually damage the circuits. Therefore, avoid placing objects against these openings and do not install the unit where the flow of air through the ventilation openings could be impeded.
6. Always set the VOLUME control to “– ∞” before starting the audio source play. Increase the volume gradually to an appropriate level after playback has been started.
7. Do not attempt to clean the unit with chemical solvents; this might damage the finish. Use a clean, dry cloth.
8. Be sure to read the “TROUBLESHOOTING” section regarding common operating errors before concluding that the unit is faulty.
9. When not planning to use this unit for long periods of time (ie., vacation, etc.), disconnect the AC power plug from the wall outlet.
10. To prevent lightning damage, disconnect the AC power plug and disconnect the antenna cable when there is an electrical storm.
11. Grounding or polarization – Precautions should be taken so that the grounding or polarization of an appliance is not defeated.
12. AC outlet
Do not connect audio equipment to the AC outlet on the rear panel if that equipment requires more power than the outlet is rated to provide.
13. **Voltage Selector (General Model only)**
The voltage selector on the rear panel of this unit must be set for your local main voltage BEFORE plugging into the AC main supply.
Voltages are 110/120/220/240V AC, 50/60 Hz.

IMPORTANT

Please record the serial number of this unit in the space below.

Serial No.:

The serial number is located on the rear of the unit.
Retain this Owner's Manual in a safe place for future reference.

WARNING

TO REDUCE THE RISK OF FIRE OR ELECTRIC SHOCK, DO NOT EXPOSE THIS UNIT TO RAIN OR MOISTURE.

The apparatus is not disconnected from the AC power source as long as it is connected to the wall outlet, even if the apparatus itself is turned off.

For U.K. customers

If the socket outlets in the home are not suitable for the plug supplied with this appliance, it should be cut off and an appropriate 3 pin plug fitted. For details, refer to the instructions described below.

Note: The plug severed from the mains lead must be destroyed, as a plug with bared flexible cord is hazardous if engaged in a live socket outlet.

Special Instructions for U.K. Model

IMPORTANT

THE WIRES IN THE MAINS LEAD ARE COLOURED IN ACCORDANCE WITH THE FOLLOWING CODE:

Blue: NEUTRAL
Brown: LIVE

As the colours of the wires in the main lead of this apparatus may not correspond with the coloured markings identifying the terminals in your plug, proceed as follows:

The wire which is coloured BLUE must be connected to the terminal which is marked with the letter N or coloured BLACK. The wire which is coloured BROWN must be connected to the terminal which is marked with the letter L or coloured RED. Make sure that neither core is connected to the earth terminal of the three pin plug.

You are the proud owner of a Yamaha stereo amplifier –an extremely sophisticated audio component. The Digital Sound Field Processor (DSP) built into this unit takes full advantage of Yamaha’s undisputed leadership in the field of digital audio processing to bring you a whole new world of listening experiences. Follow the instructions in this manual carefully when setting up your system, and this unit will sonically transform your room into a wide range of listening environments –movie theater, concert hall, and so on. In addition, you get incredible realism from Dolby-encoded video sources using the built-in Dolby Pro Logic Surround Decoder. Please read this operation manual carefully and store it in a safe place for later reference.

Digital Sound Field Processing

What is it that makes live music so good? Today’s advanced sound reproduction technology lets you get extremely close to the sound of a live performance, but chances are you’ll still notice something missing: the acoustic environment of the live concert hall. Extensive research into the exact nature of the sonic reflections that create the ambience of a large hall has made it possible for Yamaha engineers to bring you this same sound in your own listening room, so you’ll feel all the sound of a live concert.

What’s more, our technicians, armed with sophisticated measuring equipment, have even made it possible to capture the acoustics of a variety of venues such as an actual concert hall, theater, etc. to allow you to accurately recreate one of several actual live performance environments, all in your own home.

Dolby Pro Logic Surround

The Dolby Pro Logic Surround Decoder program lets you experience the dramatic realism and impact of Dolby Surround movie theater sound in your own home. Dolby Pro Logic gets its name from its professional-grade steering logic circuitry, which provides greater effective front and rear channel separation for a much higher degree of realism than the “passive” Dolby Surround circuits found in less sophisticated home audio/video equipment. Dolby Pro Logic Surround provides a true center channel, so that there are four independent channels, unlike passive Dolby Surround which has in effect only three channels: left, right, and rear. This center channel allows listeners seated in even less-than-ideal positions to hear the dialog originating from action on the

screen while getting a stereo effect as well.

Dolby Pro Logic Surround + DSP

You can also enjoy a combination of Dolby Pro Logic Surround and DSP in the sound field program “  PRO LOGIC ENHANCED”.

It recreates the surround effect of a movie theater, effectively duplicating its multiple surround loudspeaker system, completely surrounding the listener with the sounds of the action taking place on the screen.

SPEAKER SETUP FOR THIS UNIT

SPEAKERS TO BE USED

This unit is designed to provide the best sound-field quality with a 5 speaker configuration. The speakers to be used with this unit will be mainly front speakers, rear speakers, and a center speaker. (You can omit the center speaker. Refer to the “**4-Speaker Configuration**” shown below.)

The front speakers are used for the main source sound and the effect sound. They will probably be the speakers of your present stereo speaker system. The rear speakers are used for the effect sound. And the center speaker is used for the center sound (dialog etc.) encoded with the Dolby Surround. The rear and center speakers do not need to be equal in power to the front speakers. However, all the speakers should have high enough power handling to accept the maximum output of this unit.

SPEAKER CONFIGURATION

5-Speaker Configuration

This configuration is the most effective and recommended one. In this configuration, the center speaker is necessary as well as the rear speakers. If the digital sound field program **DOLBY PRO LOGIC** or **DOLBY PRO LOGIC ENHANCED** is selected, conversations will be output from the center speaker and the ambience will be excellent.

- Set the center channel mode to the “**NORMAL**” or “**WIDE**” position. (For details, refer to page 13.)

4-Speaker Configuration

The center speaker is not used in this configuration. If the digital sound field program **DOLBY PRO LOGIC** or **DOLBY PRO LOGIC ENHANCED** is selected, the center sound is output from the left and the right front speakers. However, the sound effect of other programs can be the same as that of the 5-speaker configuration.

- Be sure to set the center channel mode to the “**PHANTOM**” position. (For details, refer to page 13.)

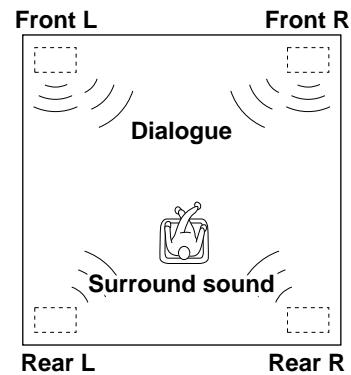
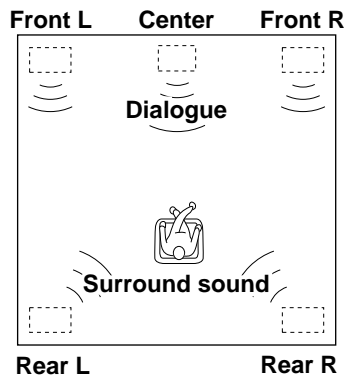

SPEAKER PLACEMENT

The recommended speaker configuration, the 5-speaker configuration, will require two speaker pairs: **front speakers** (your normal stereo speakers), and **rear speakers**, plus a **center speaker**. When you place these speakers, refer to the following.

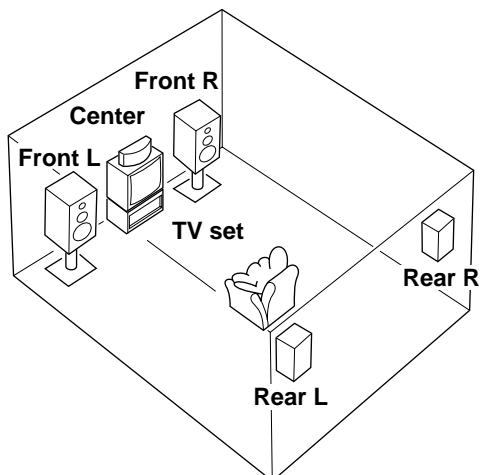

- Front:** In normal position. (The position of your present stereo speaker system.)
- Rear:** Behind your listening position, facing slightly inward. Nearly six feet (approx. 1.8 m) up from the floor.
- Center:** Precisely between the front speakers. (To avoid interference with TV sets, use a magnetically shielded speaker.)

CONNECTIONS

Before attempting to make any connections to or from this unit, be sure to first switch OFF the power to this unit and to any other components to which connections are being made.

CONNECTIONS WITH OTHER COMPONENTS

When making connections between this unit and other components, be sure all connections are made correctly, that is to say L (left) to L, R (right) to R, “+” to “+” and “-” to “-”. Also, refer to the owner’s manual for each component to be connected to this unit.

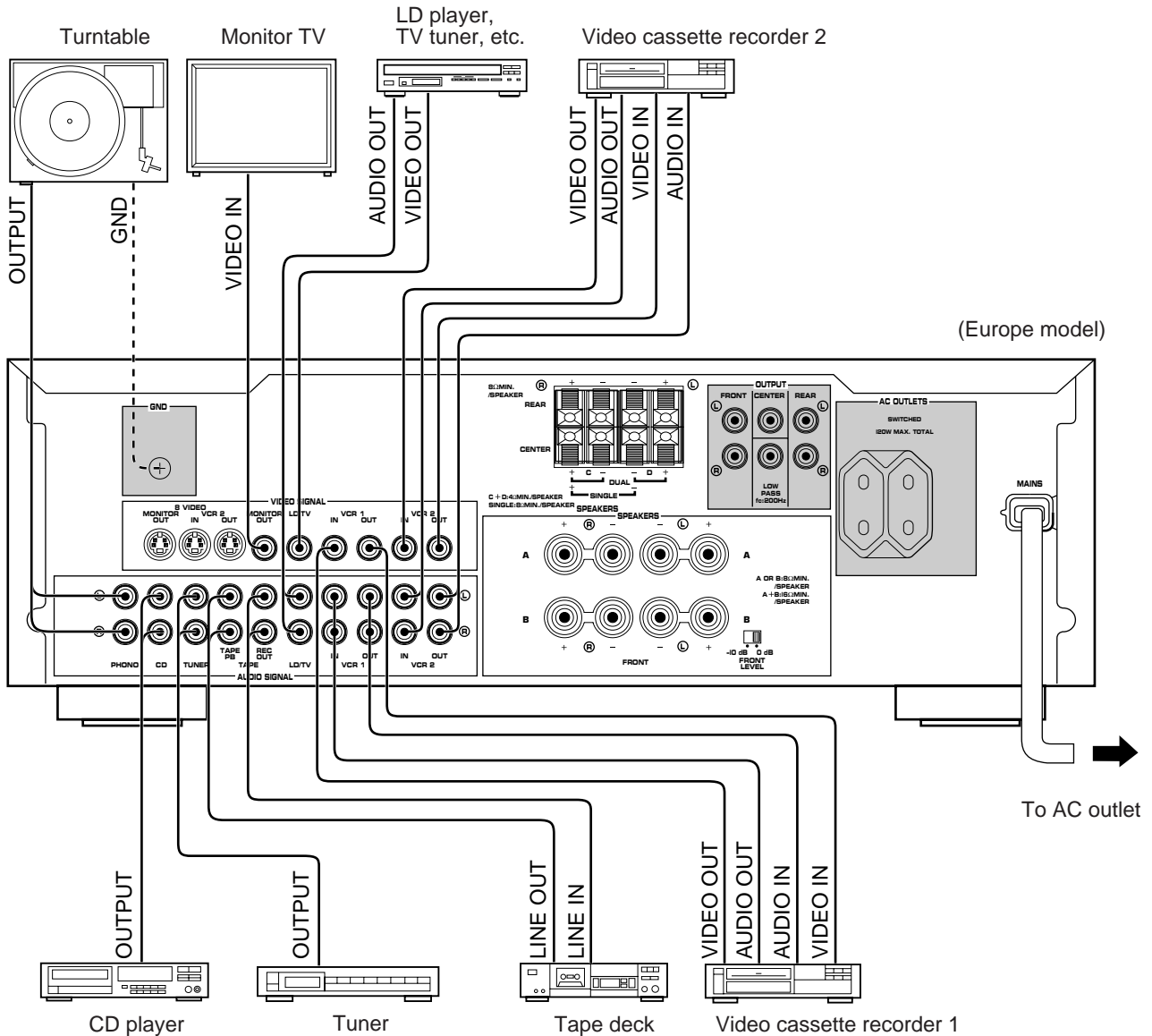

Refer to “ABOUT THE ACCESSORY TERMINALS” on page 11.

CONNECTING TO S VIDEO TERMINALS

If you have a video cassette recorder and a monitor equipped with “S” (high-resolution) video terminals, those terminals can be connected to this unit’s **S VIDEO** terminals. Connect the video cassette recorder’s “S” video input and output terminals to this unit’s **S VIDEO VCR 2 IN** and **OUT** terminals respectively, and connect the monitor’s “S” video input terminal to this unit’s **S VIDEO MONITOR OUT** terminal. Otherwise, connect the video cassette recorder’s composite video terminals to this unit’s composite video terminals, and connect the monitor’s composite video input terminal to this unit’s composite **MONITOR OUT** terminal.

Note
If video signals are sent to both **S VIDEO** input and composite input terminals, the signals will be sent to their respective output terminals independently.

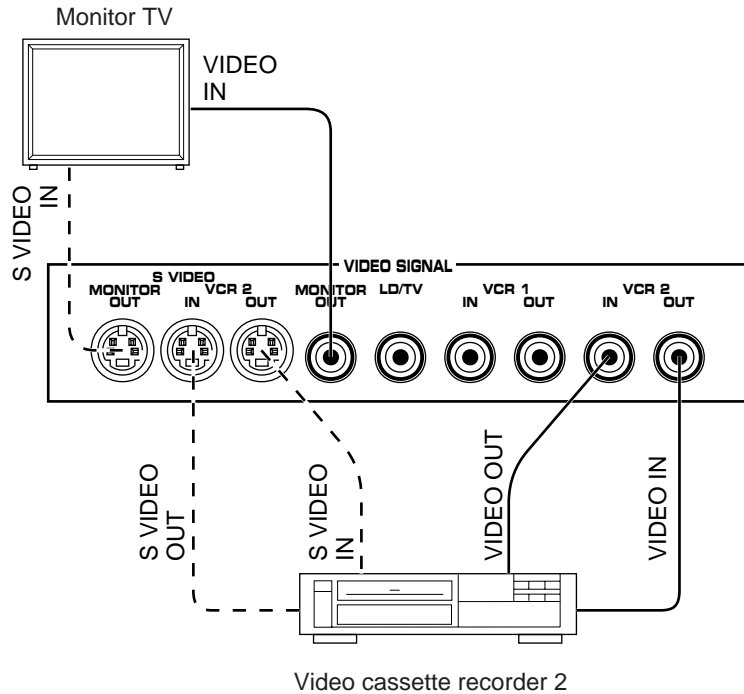

CONNECTING TO VIDEO AUX TERMINALS (ON THE FRONT PANEL)

These terminals are used to connect any video input source such as a camcorder to this unit.

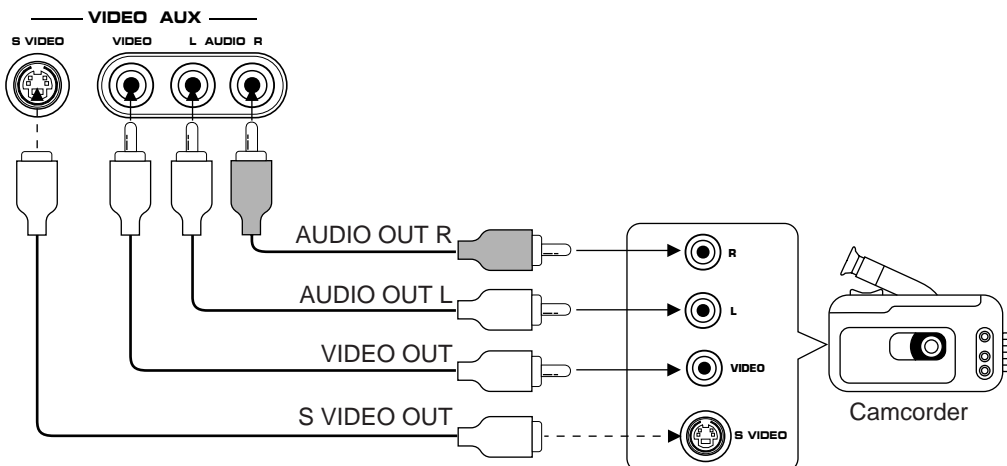

CONNECTING SPEAKERS

Connect the respective speakers to this unit as figured below.

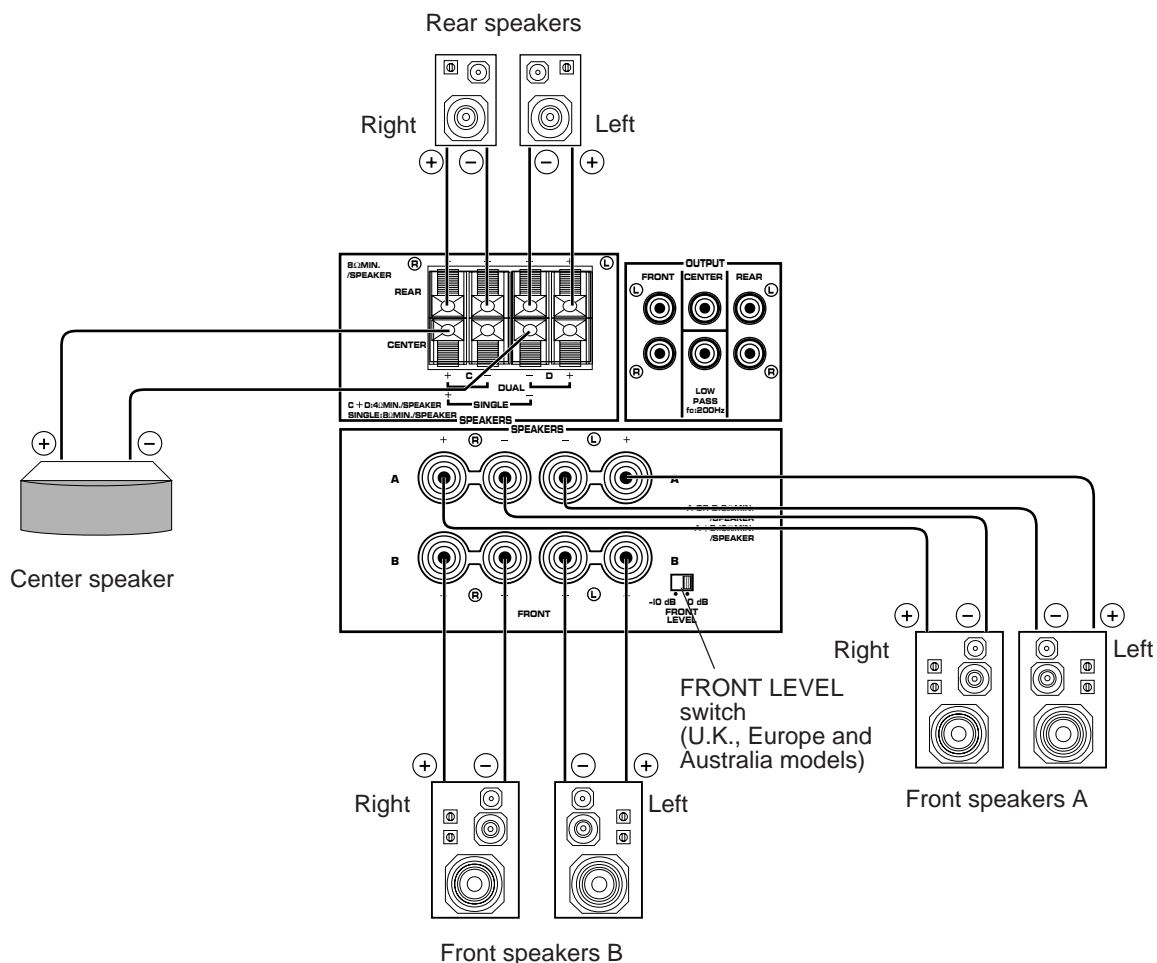

Note on front speaker connection:

One or two speaker systems can be connected to this unit. If you connect only one speaker system, connect it to either the **SPEAKERS A** or **B** terminals.

Note on center speaker connection:

One or two center speakers can be connected to this unit. If you cannot place the center speaker on or under the TV, it is recommended to use two center speakers and place them on both sides of the TV to orient the center sound at the center position. For connecting two center speakers, follow the method shown below.

FRONT LEVEL switch

<U.K., Europe and Australia models only>

Normally set to "0 dB". If desired, you can decrease the output level at the **FRONT SPEAKERS** terminals by 10 dB by setting this switch to "-10 dB".

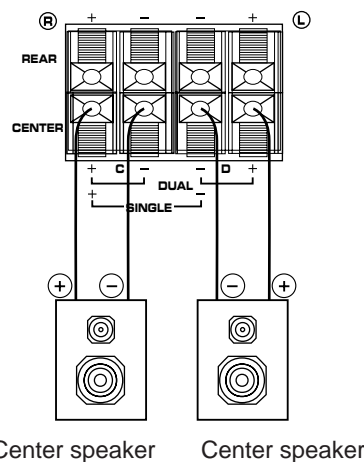
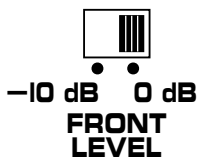

How to Connect:

Connect the **SPEAKERS** terminals to your speakers with wire of the proper gauge, cut as short as possible. If the connections are faulty, no sound will be heard from the speakers. Make sure that the polarity of the speaker wires is correct, that is, + and – markings are observed. If these wires are reversed, the sound will be unnatural and will lack bass.

Do not let the bare speaker wires touch each other and do not let them touch the metal parts of this unit as this could damage this unit and/or speakers.

Note

Use speakers with the specified impedance shown on the rear of this unit.

For connecting to the FRONT SPEAKERS terminals

Red: positive (+)
Black: negative (-)

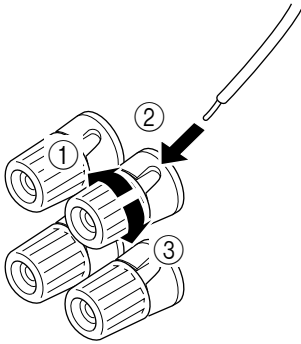

- ① Unscrew the knob.
- ② Insert the bare wire.
[Remove approx. 5mm (1/4") insulation from the speaker wires.]
- ③ Tighten the knob and secure the wire.

For connecting to the REAR and CENTER SPEAKERS terminals

Red: positive (+)
Black: negative (-)

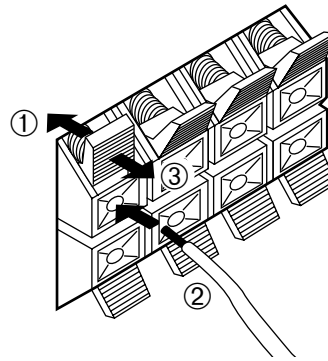

- ① Press up the tab.
- ② Insert the bare wire.
[Remove approx. 5mm (1/4") insulation from the speaker wires.]
- ③ Release the tab and secure the wire.

* <General model only>

Banana Plug connections are also possible. Simply insert the Banana Plug connector into the corresponding terminal.

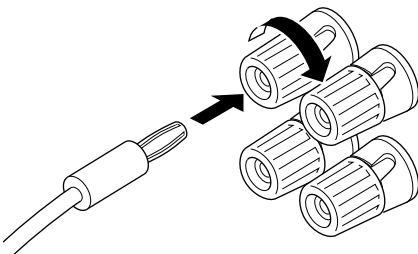

ABOUT THE ACCESSORY TERMINALS

AC OUTLET(S) (SWITCHED)

(Europe and General models) 2 SWITCHED OUTLETS
(U.K. and Australia models) 1 SWITCHED OUTLET
Use these to connect the power cords from your components to this unit.

The power to the **SWITCHED** outlets is controlled by this unit's **POWER** switch or the provided remote control transmitter's **POWER** key. These outlets will supply power to any component whenever this unit is turned on.

The maximum power (total power consumption of components) that can be connected to the **SWITCHED AC OUTLET(S)** is 120 watts.

GND terminal (For turntable use)

Connecting the ground wire of the turntable to this terminal will normally minimize hum, but in some cases better results may be obtained with the ground wire disconnected.

LOW PASS terminal

This terminal is for output to a monaural amplifier driving a subwoofer. Only frequencies below 200 Hz from the front and center channels are output.

FRONT OUTPUT terminals

These terminals are for front channel line output. There is no connection to these terminals when you use the built-in amplifier.

However, if you drive front speakers with an external stereo power amplifier, connect the input terminals of the external amplifier (MAIN IN or AUX terminals of a power amplifier or an integrated amplifier) to these terminals.

REAR OUTPUT terminals

These terminals are for rear channel line output. There is no connection to these terminals when you use the built-in amplifier.

However, if you drive rear speakers with an external stereo power amplifier, connect the input terminals of the external amplifier (MAIN IN or AUX terminals of a power amplifier or an integrated amplifier) to these terminals.

CENTER OUTPUT terminal

This terminal is for center channel line output. There is no connection to this terminal when you use the built-in amplifier. However, if you drive a center speaker with an external power amplifier, connect the input terminal of the external amplifier to this terminal.

ADDING A SUBWOOFER

You may wish to add a subwoofer to reinforce the bass frequencies.

Connect the **LOW PASS** terminal to the INPUT terminal of the subwoofer amplifier, and connect the speaker terminals of the subwoofer amplifier to the subwoofer.

With some subwoofers, including the Yamaha Active Servo Processing Subwoofer System, the amplifier and subwoofer are in the same unit.

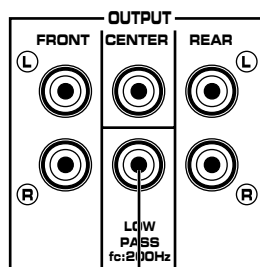

Subwoofer system

SPEAKER BALANCE ADJUSTMENT

This procedure lets you adjust the sound output level balance between the front, center, and rear speakers using the built-in test tone generator. With this adjustment, the sound output level heard at the listening position will be the same from each speaker. This is important for the best performance of the digital sound field processor.

The adjustment of each speaker output level should be done at your listening position with the remote control transmitter. Otherwise, the result may not be satisfactory.

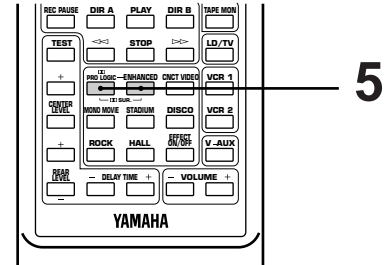
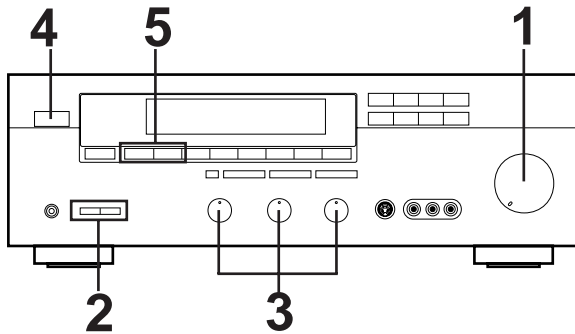

1

Set to the "∞" position.

2 Select the front speakers to be used.

SPEAKERS

A	B
ON	ON
OFF	OFF

* If you use two front speaker systems, press both the A and B switches.

3

Set to the "0" position.

4

5 Select the PRO LOGIC or PRO LOGIC ENHANCED mode, so that the corresponding name is illuminated on the display.

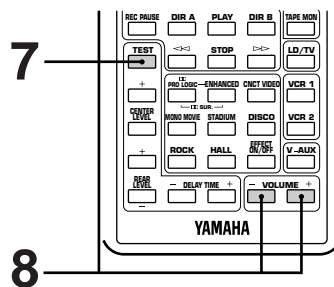
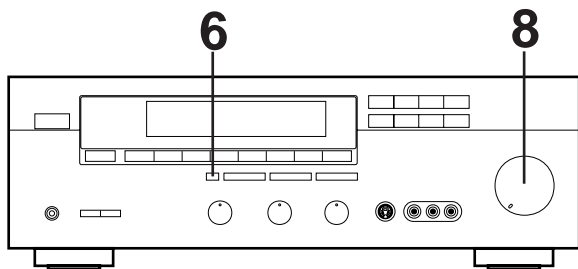

6 Select the center channel output mode according to your speaker configuration.
(Refer to “**SPEAKER CONFIGURATION**” on page 6.)

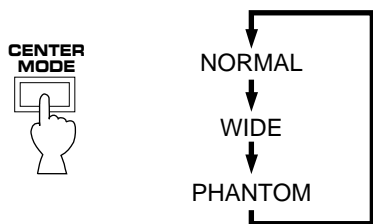

On the feature of each mode, refer to the “**Note**” shown below.

Note

In step 6, when you select the center channel output mode, note the following.

For 5 speaker configuration)

NORMAL: Select this mode when you use a center speaker that is smaller than the front speakers. In this mode, the bass tone will be output from the front speakers.

WIDE: Select this mode when you use the center speaker approximately same sized as the front speakers.

For 4 speaker configuration)

PHANTOM: Select this mode when you do not use the center speaker. The center sound will be output from the left and right front speakers.

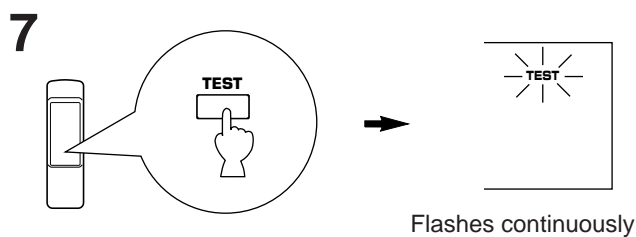

8 Turn up the volume.

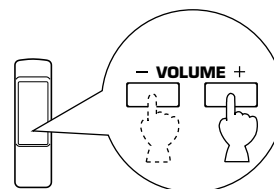

You will hear a test tone (like pink noise) from the left front speaker, then the center speaker, then the right front speaker, and then the rear speakers, for about two seconds each. The display changes as shown below.

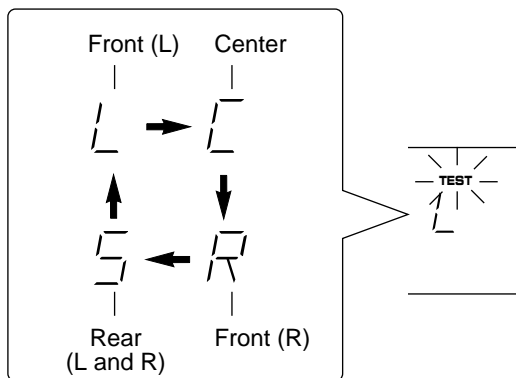

* The test tone from the left rear speaker and the right rear speaker will be heard at the same time.

CONTINUED

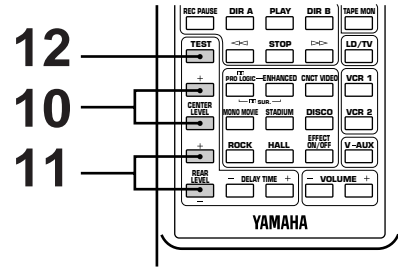
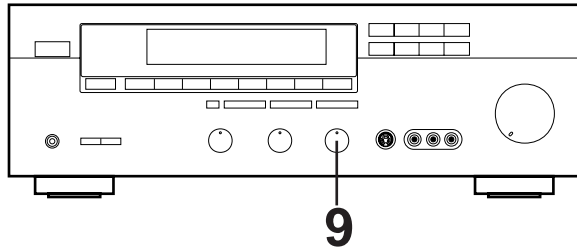

9 Adjust the **BALANCE** control so that the effect sound output level of the left front speaker and the right front speaker are the same.



10 Adjust the sound output level of the center speaker to be at the same level as that of the front speakers with the **CENTER LEVEL** keys.

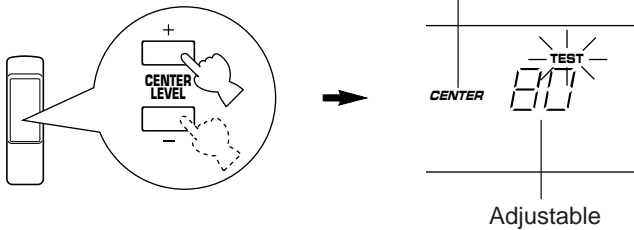

11 Adjust the sound output level of the rear speakers to be at the same level as that of the front speakers with the **REAR LEVEL** keys.

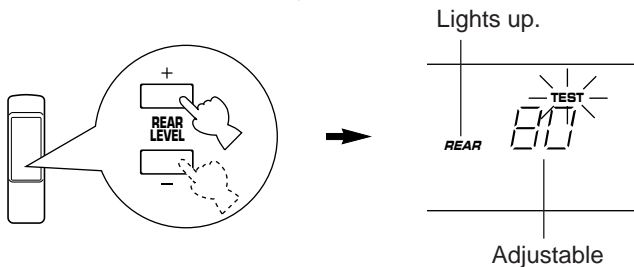

12 Cancel the test tone.

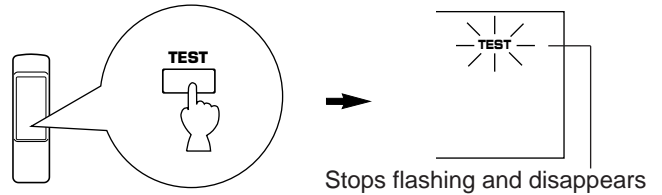

Notes

- Once you have completed these adjustments, you can adjust whole sound level on your audio system by using the **VOLUME** control (or the **VOLUME** keys on the remote control transmitter).
- If you use external power amplifiers, their volume controls may also be adjusted to achieve proper balance.
- In step 10, if the center channel mode is in the "PHANTOM" position, the sound output level of the center speaker cannot be adjusted. This is because in this mode, the center sound is automatically output from the left and right front speakers.
- **<U.K., Europe and Australia models only>**
If there is insufficient sound output from the center and rear speakers, you may decrease the front speaker output level by setting the **FRONT LEVEL** switch on the rear panel to "−10 dB".

BASIC OPERATIONS

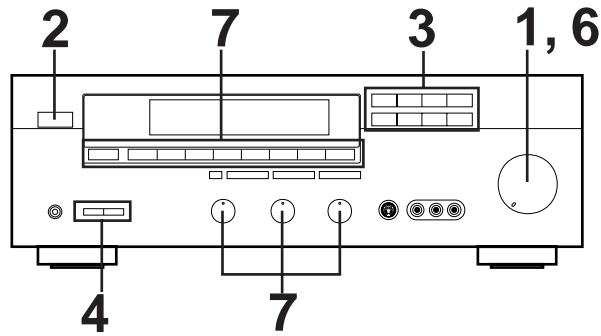

TO PLAY A SOURCE

1

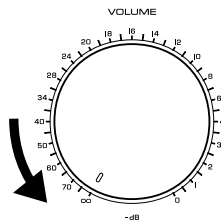

Set to the "∞" position.

2

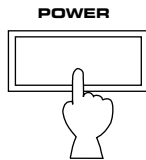

3

Select the desired input source by using the input selector buttons.
(For video sources, turn the TV/monitor ON.)

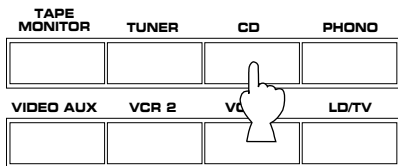

* The name of the selected input source will appear in the display.

4

Select the front speakers to be used.

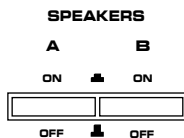

* If you use two front speaker systems, press both the A and B switches.

5

Play the source.

6

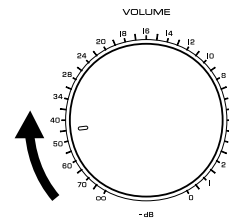

Adjust to the desired output level.

7

If desired, adjust the **BASS, TREBLE, BALANCE** controls, etc. (refer to page 17) and use the digital sound field processor. (Refer to page 20.)

Notes on using the input selector buttons

- Note that pressing on each input selector button selects the source which is connected to the corresponding input terminals on the rear panel.
- * To select the source connected to the **VIDEO AUX** terminals on the front panel, press **VIDEO AUX**.
- The selection of **TAPE MONITOR** cannot be canceled by pressing another input selector button. To cancel it, press **TAPE MONITOR** again.
When you select a button other than **TAPE MONITOR**, make sure that **TAPE MONITOR** is not also selected.
- If you select the input selector button for a video source without canceling the selection of **TAPE MONITOR**, the playback result will be the video image from the video source and the sound from the audio tape.
- Once you play a video source, its video image will not be interrupted even if the input selector button for an audio source is selected.

To turn off the power

Press the **POWER** switch again.

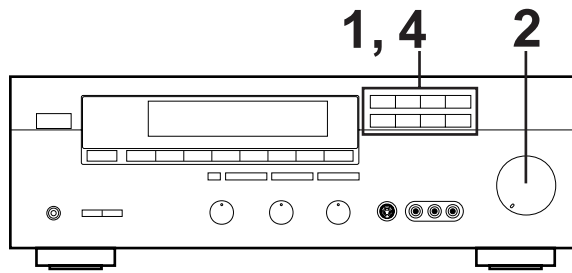

TO RECORD A SOURCE TO TAPE (OR DUB FROM TAPE TO TAPE)

- 1** Select the source to be recorded.

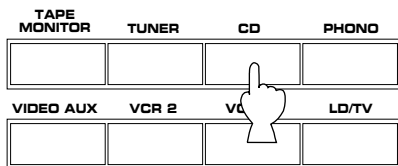

- 2** Play the source and then turn the **VOLUME** control up to confirm the input source.

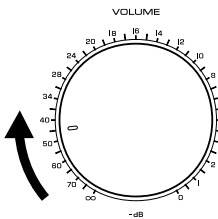

- 3** Set the tape deck or VCR to the recording mode.

- 4** If the tape deck is used for recording, you can monitor the sounds being recorded by pressing **TAPE MONITOR**.

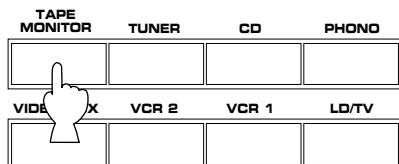

Note

DSP, VOLUME, BASS, TREBLE and BALANCE control settings have no effect on the material being recorded.

Selecting the SPEAKER system

Because one or two speaker systems (as front speakers) can be connected to this unit, the **SPEAKERS** switches allow you to select speaker system **A** or **B**, or both at once.

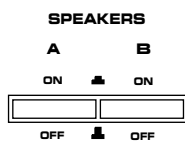

Adjusting the BALANCE control

Adjust the balance of the output volume to the left and right speakers to compensate for sound imbalance caused by speaker location or listening room conditions.



Note

This control is effective only for the sound from the front speakers.

Adjusting the BASS and TREBLE controls

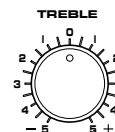
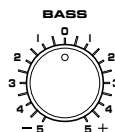

BASS : Turn this clockwise to increase (or counter-clockwise to decrease) the low frequency response.

TREBLE : Turn this clockwise to increase (or counter-clockwise to decrease) the high frequency response.

Note

These controls are effective only for the sound from the front speakers.

When you listen with headphones

Connect the headphones to the **PHONES** jack. You can listen to the sound to be output from the front speakers through headphones.

When listening with headphones privately, set both the **SPEAKERS A** and **B** switches to the **OFF** position and switch off the digital sound field processor (so that no DSP program name is illuminated on the display) by pressing the **EFFECT** switch.

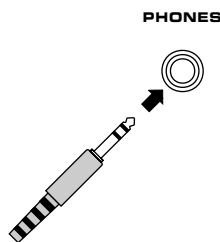

USING DIGITAL SOUND FIELD PROCESSOR (DSP)

This unit incorporates a sophisticated, multi-program digital sound field processor, which allows you to expand and shape the audio sound field from both the audio and video sources, for a theater-like experience in the listening/viewing room. This digital sound field processor has 8 programs; 6 programs for digital sound field processing and 2 programs for the Dolby Pro Logic Surround sound system (**DOLBY PRO LOGIC** and **DOLBY PRO LOGIC ENHANCED**). You can create an excellent audio sound field by selecting the suitable program and adding desired adjustments. In addition, when the **DOLBY PRO LOGIC** or **DOLBY PRO LOGIC ENHANCED** program is selected, the built-in automatic input balance control functions. This presents you the best surround condition without manual adjustment.

Front Panel

Displays your selection on the DSP or other informations.

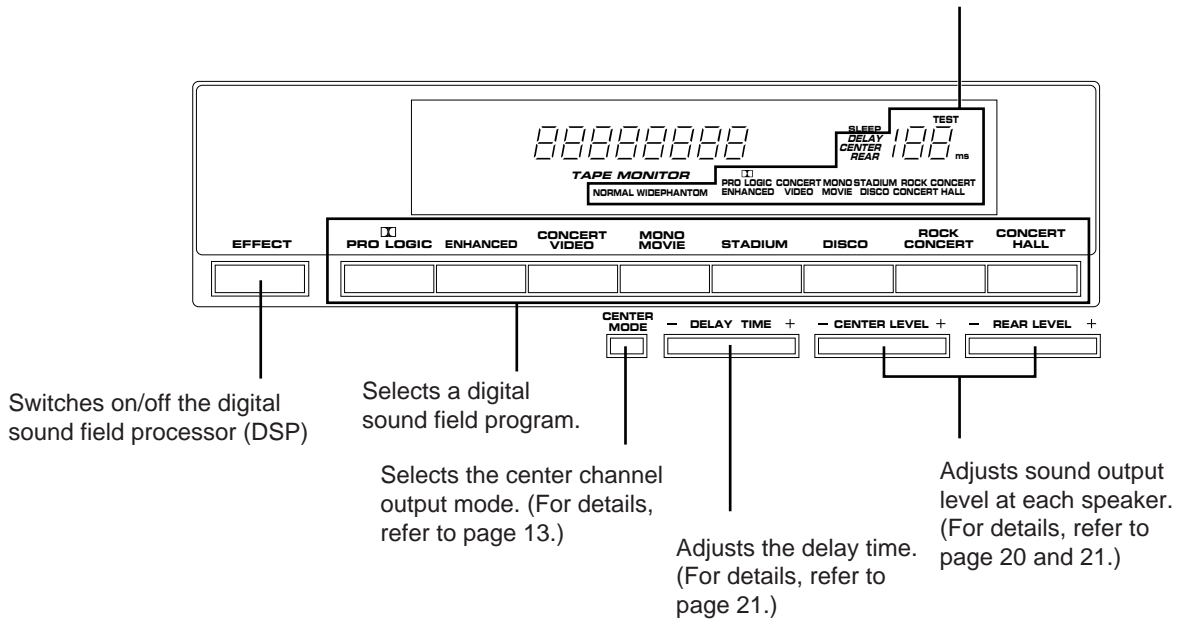

Remote Control Transmitter

Used for speaker balance adjustment (For details, refer to page 12, 13 and 14.)

Adjusts sound output level at each speaker. (For details, refer to page 20 and 21.)

Selects a digital sound field program.

Switches on/off the digital sound field processor (DSP).

Adjusts the delay time. (For details, refer to page 21.)

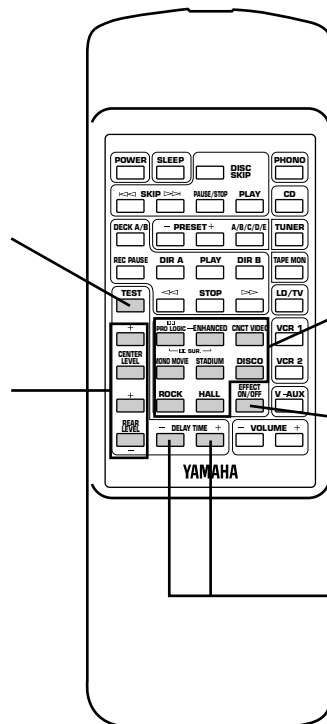

Description of Each Sound Field Program

The following list gives brief descriptions of the sound fields produced by each of the DSP programs. Keep in mind that most of these are precise digital recreations of actual acoustic environments. The data for them was recorded at the locations described using sophisticated sound field measurement equipment.

Note

The channel level balance between the left rear effect speaker and the right rear effect speaker may vary depending on the sound field you are listening to. This is due to the fact that most of these sound field recreations are actual acoustic environments.

PROGRAM	FEATURE
PRO LOGIC	This program is effective for playback of sources encoded with Dolby Surround. The employment of the digital signal processing system improves crosstalk and transfers the sound source more smoothly and precisely, compared to the conventional type. A stable movie sound field is recreated.
PRO LOGIC ENHANCED	This program is effective for playback of sources encoded with Dolby Surround. Enhancing the "Normal" Dolby Pro Logic, the DSP technology simulates the multi-surround speaker systems of a 35 mm film theater, thus widening the surrounded-sound field with greater presence.
CONCERT VIDEO	This program is effective for music videos and gives excellent depth and clarity for vocals. For opera, the orchestra and stage are ideally recreated, letting you feel as if you were in an actual concert hall.
MONO MOVIE	This program is designed specifically to enhance mono source programs. Compared to a strictly mono setting, the sound image created in this mode is wider and slightly forward of the speaker pair, lending an immediacy to the overall sound. It is particularly effective when used with old mono movies, news broadcasts and dialog.
STADIUM	This program gives you long delays between direct sounds and effect sounds, and extraordinarily spacious feel of a large stadium.
DISCO	This program recreates the acoustic environment of a lively disco in the heart of a very lively city. The sound is dense and highly concentrated. It is also characterized by a high-energy, "immediate" sound.
ROCK CONCERT	This program is suitable for rock music. A big, powerful sound is reproduced lively and dynamically.
CONCERT HALL	In this program, the center seems deep behind the front speaker pair, creating an expansive, large hall ambience.

Description of Dolby Pro Logic Surround

DOLBY PRO LOGIC SURROUND: This unit employs the Dolby Pro Logic Surround system. This system is similar to professional Dolby Stereo decoders used in movie theaters. By employing a four-channel system, the Dolby Pro Logic Surround system divides the input signals into four levels: the left and right main channels, the center channel (to characterize dialog), and the rear surround-sound channels (to characterize sound effects, background noise and other ambient noise).

Dolby Surround is encoded on the sound track of commercially available video cassettes and video discs as well. When you play a source encoded with Dolby Surround on your home video system, the Dolby Pro Logic Surround system in this unit decodes the signal and feeds the surround-sound effects. The Dolby Pro Logic Surround mode may not be always effective on video sources not encoded with Dolby Surround.

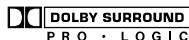

Manufactured under license from Dolby Laboratories Licensing Corporation. Additionally licensed under Canadian patent number 1,037,877. "Dolby", "Pro Logic", and the double-D symbol are trademarks of Dolby Laboratories Licensing Corporation.

To play a source with the digital sound field processor

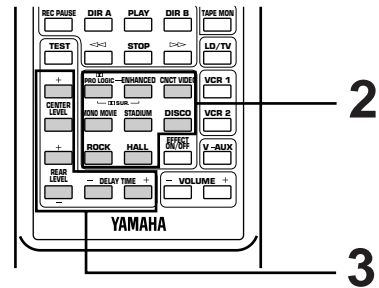
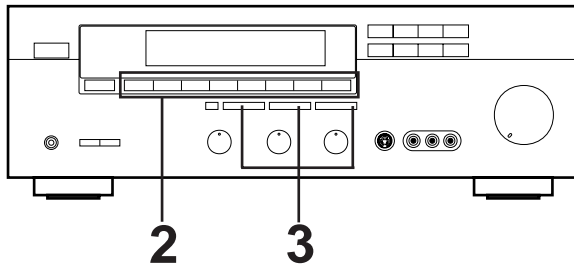

1 Follow steps 1 – 6 shown in “**BASIC OPERATIONS**” on page 15.

2 Select the desired program that is suitable for the source.

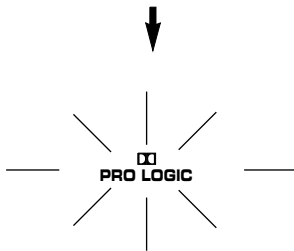
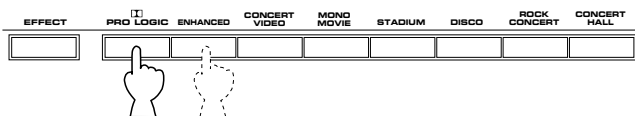

The selected program name is shown on the display.

3 If desired, adjust the delay time and the output level of each speaker. (For details, refer to the corresponding descriptions on this page and the next page.)

Notes

- If you prefer to cancel the DSP, press the **EFFECT** switch. The sound will be the normal 2-channel stereo without surround sound effect.
- When **CONCERT VIDEO**, **MONO MOVIE**, **STADIUM**, **DISCO**, **ROCK CONCERT** or **CONCERT HALL** is selected, no sound is heard from the center speaker.
- When a monaural sound source is played with **DOLBY PRO LOGIC** or **DOLBY PRO LOGIC ENHANCED**, no sound is heard from the front speakers and the rear speakers. Sound is heard only from the center speaker. However, if the center channel mode is in **PHANTOM**, the front speakers output the sound of the center channel.
- When this unit's Dolby Pro Logic Surround system is used, if the main-source sound is considerably altered by overadjustment of the **BASS** or **TREBLE** controls, the relationship between the center and rear channels may produce an unnatural effect.

* The following adjustments can be done on the remote control transmitter as well as on the front panel.

Adjustment of the CENTER LEVEL

If desired, you can adjust the sound output level of the center speaker even if the output level is already set in “**SPEAKER BALANCE ADJUSTMENT**” on page 14.

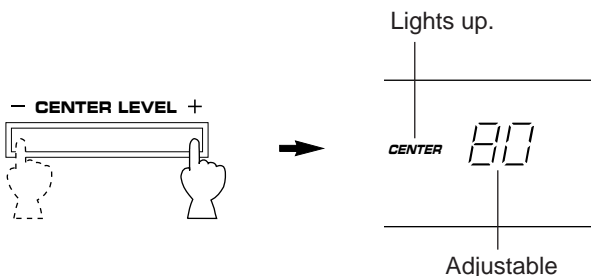

By continuously pressing “+” or “-” on the **CENTER LEVEL** control, the level value changes continuously. However, the value stops changing momentarily at the preset point (80).

- If the digital sound field program **CONCERT VIDEO**, **MONO MOVIE**, **STADIUM**, **DISCO**, **ROCK CONCERT** or **CONCERT HALL** is selected, the **CENTER LEVEL** control cannot function.
- Once the output level is adjusted, the level value will be the same in the **DOLBY PRO LOGIC** and **DOLBY PRO LOGIC ENHANCED** programs.
- If a digital sound field program is not used, the **CENTER LEVEL** control will not function.

Adjustment of the REAR LEVEL

If desired, you can adjust the sound output level of the rear speakers even if the output level is already set in “**SPEAKER BALANCE ADJUSTMENT**” on page 14.

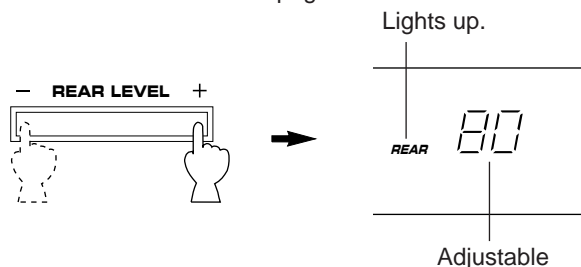

By continuously pressing “+” or “-” on the **REAR LEVEL** control, the level value changes continuously. However, the value stops changing momentarily at the preset point (80).

- Once the output level is adjusted, the level value will be the same in all the digital sound field programs.
- If **DOLBY PRO LOGIC** or a digital sound field program is not used, the **REAR LEVEL** control will not function.

Adjustment of DELAY TIME

You can adjust the time difference between the beginning of the source sound and the beginning of the effect sound with the **DELAY TIME** control.

The **DELAY TIME** control is effective with all programs. By applying more or less delay, sound effects, background noise, and ambient noise coming at you from the rear speakers can be enhanced or subdued for extra effect.

1. **PRO LOGIC** : from 15 to 30 milliseconds
(Preset value: 20 milliseconds)
2. **PRO LOGIC ENHANCED** : from 15 to 30 milliseconds
(Preset value: 20 milliseconds)
3. **CONCERT VIDEO** : from 1 to 100 milliseconds
(Preset value: 28 milliseconds)
4. **MONO MOVIE** : from 1 to 100 milliseconds
(Preset value: 20 milliseconds)
5. **STADIUM** : from 1 to 50 milliseconds
(Preset value: 45 milliseconds)
6. **DISCO** : from 1 to 100 milliseconds
(Preset value: 14 milliseconds)
7. **ROCK CONCERT** : from 1 to 100 milliseconds
(Preset value: 17 milliseconds)
8. **CONCERT HALL** : from 1 to 100 milliseconds
(Preset value: 30 milliseconds)

By continuously pressing “+” or “-” on the **DELAY TIME** control, the value changes continuously. However, the value stops changing momentarily at the preset point.

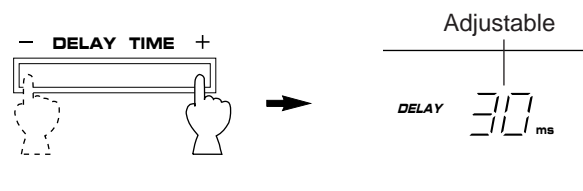

Note

Adding too much delay will cause an unnatural effect with some sources. Experiment with the **DELAY TIME** control to create the effect that you find most suitable.

Note

The values of the **DELAY TIME**, **CENTER LEVEL** and **REAR LEVEL** you set the last time will remain memorized even when the power of this unit is off.

However, if the power cord is kept disconnected for more than one week, these values will be automatically changed back to the original factory settings.

SETTING THE SLEEP TIMER

If you use the SLEEP timer of this unit, you can make this unit turn off automatically. When you are going to sleep while enjoying a broadcast or other desired input source, this timer function is helpful.

Notes

- The SLEEP timer can be controlled only with the remote control transmitter.
- The components on which the SLEEP timer is effective are the sources connected to the **SWITCHED AC OUTLET(S)** on the rear panel of this unit.

To set the SLEEP time

1

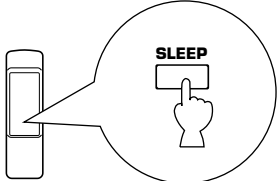

Press once or more to select the desired SLEEP time.

↓

Indicates the SLEEP time.



Flashes on and off continuously.

Whenever the **SLEEP** key is pressed, the SLEEP time will change as follows.

(Minutes)

120 → 90 → 60 → 30

The SLEEP timer is OFF.
(The indication before the **SLEEP** key is pressed.)

After a while, the display returns to the indication before the SLEEP timer is set, and the "SLEEP" indicator stops flashing and lights up.

2 The unit will be turned off automatically at the selected SLEEP time.

To cancel the selected SLEEP time

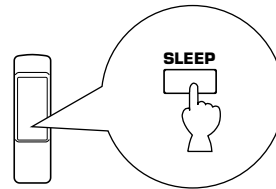

Press once or more so that the display returns to the indication before the SLEEP timer is set. ("SLEEP" will go off from the display.)

Note

The SLEEP timer setting can also be canceled by turning off the power with the **POWER** switch or disconnecting the power plug of this unit from the AC outlet.

REMOTE CONTROL TRANSMITTER

The remote control transmitter provided with this unit is designed to control all the most commonly used functions of the unit. If the CD player, tuner and tape deck connected to this unit are YAMAHA components, then this remote control transmitter will also control various functions of each component.

KEY FUNCTIONS

For Control of This Unit

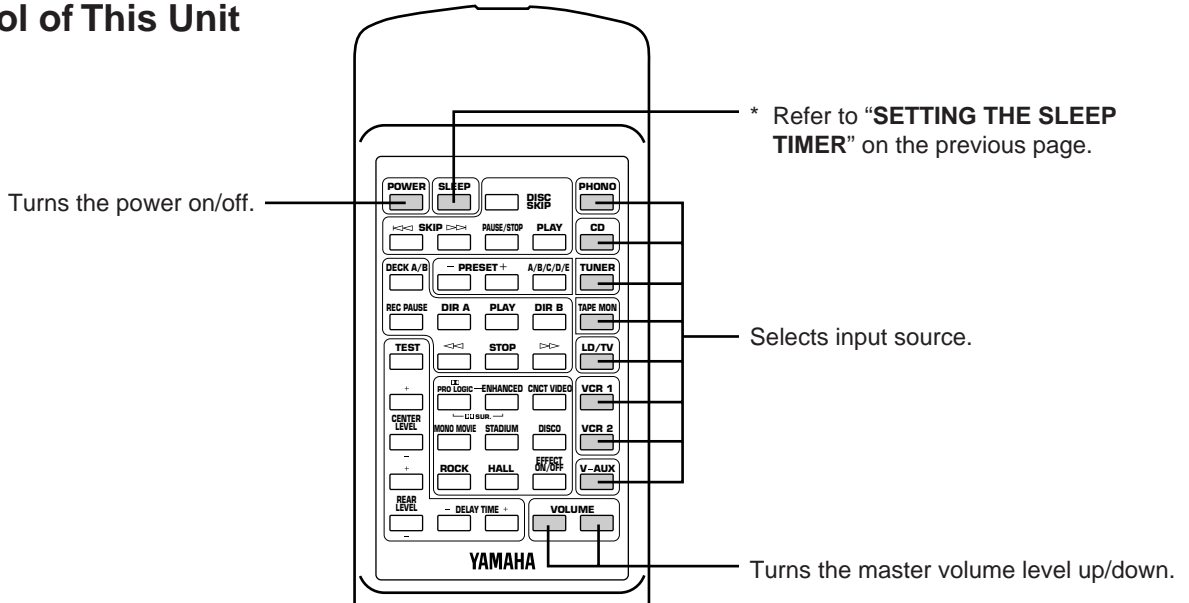

* For the DSP control keys, refer to the page 18.

For Other Component Control

Identify the remote control transmitter keys with your component's keys. If these keys are identical, their function will be the same. On each key function, refer to the corresponding instruction on your component's manual.

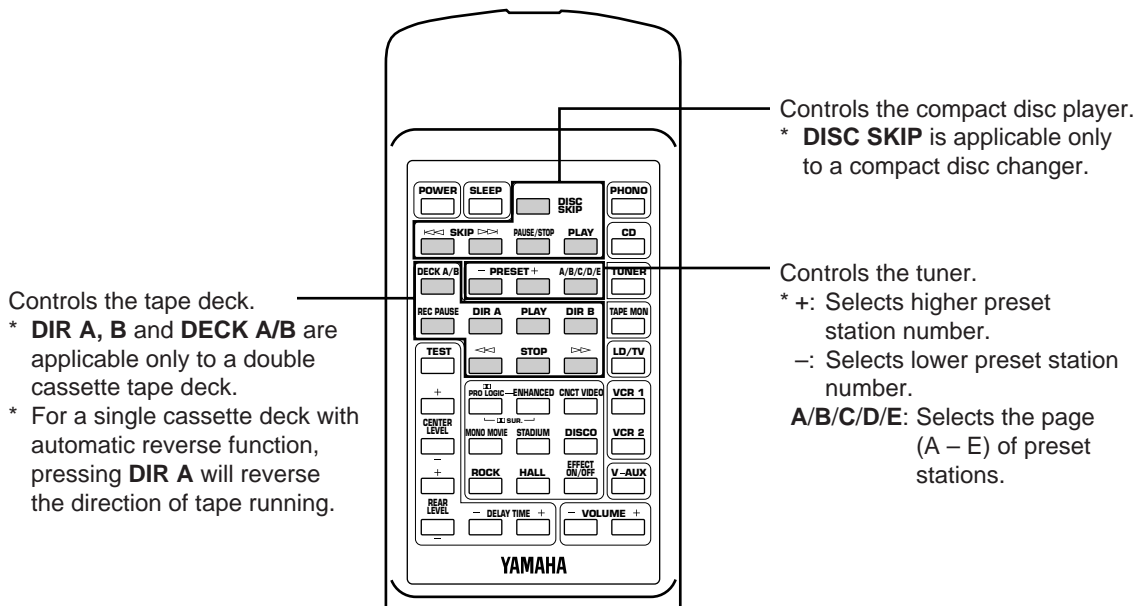

STANDBY mode (U.K. and Europe models only)

While the power is on, pressing the **POWER** key on the remote control transmitter switches the unit to the **STANDBY** mode. (In this mode, the indicator is half illuminated.)

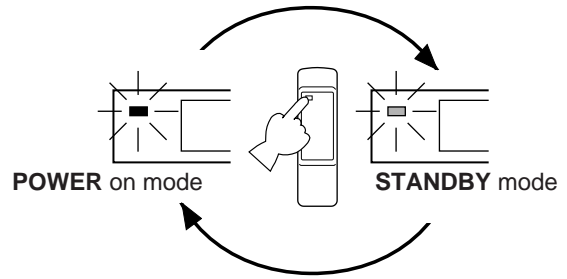

NOTES ABOUT THE REMOTE CONTROL TRANSMITTER

Battery installation

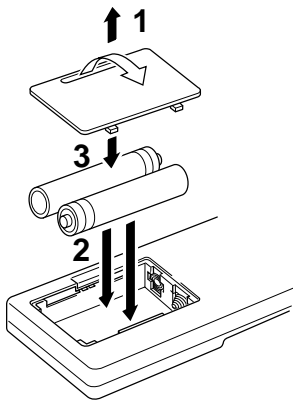

Battery replacement

If you find that the remote control transmitter must be used closer to the main unit, the batteries are weak. Replace both batteries with new ones.

Notes

- Use only AA, R6, UM-3 batteries for replacement.
- Be sure the polarities are correct. (See the illustration inside the battery compartment.)
- Remove the batteries if the remote control transmitter will not be used for an extended period of time.
- If batteries leak, dispose of them immediately. Avoid touching the leaked material or letting it come in contact with clothing, etc. Clean the battery compartment thoroughly before installing new batteries.

Remote control transmitter operation range

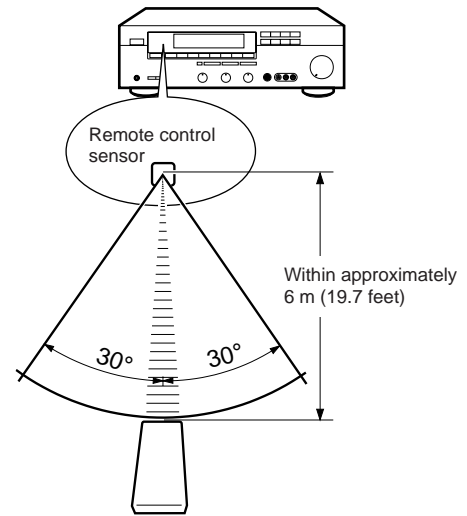

Notes

- There should be no large obstacles between the remote control transmitter and the main unit.
- If the remote control sensor is directly illuminated by strong lighting (especially an inverter type of fluorescent lamp etc.), it might cause the remote control transmitter not to work correctly. In this case, reposition the main unit to avoid direct lighting.

TROUBLESHOOTING

If the unit fails to operate normally, check the following points to determine whether the fault can be corrected by the simple measures suggested. If it cannot be corrected, or if the fault is not listed in the SYMPTOM column, disconnect the power cord and contact your authorized YAMAHA dealer or service center for help.

SYMPTOM	CAUSE	REMEDY
The unit fails to turn on when the POWER switch is pressed.	Power cord is not plugged in or is not completely inserted.	Firmly plug in the power cord.
No sound or no picture.	Incorrect output cord connections.	Connect the cords properly. If the problem persists, the cords may be defective.
	Appropriate input selector is not pressed.	Press the appropriate input selector corresponding to the input source.
The sound suddenly goes off.	The protection circuit has been activated because of short circuit etc.	Turning the unit off and then on will reset the protection circuit.
	The SLEEP timer functioned.	Do not make the SLEEP timer function.
Only one side speaker outputs the sound.	Incorrect setting of the BALANCE control.	Adjust it to the appropriate position.
	Incorrect cord connections.	Connect the cords properly. If the problem persists, the cords may be defective.
Sound "hums".	Incorrect cord connections.	Firmly connect the audio plugs. If the problem persists, the cords may be defective.
	No connection from the turntable to the GND terminal.	Make the GND connection between the turntable and this unit.
The volume level is low while playing a record.	The record is being played on a turntable with an MC cartridge.	The player should be connected to the unit through the MC head amplifier.
The volume level cannot be increased, or sound is distorted.	The power to the component connected to the REC OUT terminals of this unit is off.	Turn the power to the component on.
No sound from the rear speakers.	The sound output level to the rear speakers is set to 0.	Turn up the sound output level with the REAR LEVEL control.
	The monaural sound source is played in DOLBY PRO LOGIC or DOLBY PRO LOGIC ENHANCED mode.	Select another program suitable for the monaural sound source.
No sound from the center speaker.	The sound output level to the center speaker is set to 0.	Turn up the sound output level with the CENTER LEVEL control.
	The center channel mode is in PHANTOM mode.	Select NORMAL or WIDE.
	Incorrect sound field program selection.	Select the appropriate program.
	No sound field program is selected.	
The remote control transmitter does not work.	Direct sunlight or lighting (of an inverter type of fluorescent lamp etc.) is striking the remote control sensor of the main unit.	Change the position of the main unit.
	The batteries of this remote control transmitter are too weak.	Replace the batteries with new ones.
The sound is degraded when monitoring is performed by using the headphones connected to the compact disc player or cassette deck which are connected with this unit.	The power to this unit is off.	Turn the power to this unit on.

SPECIFICATIONS

AUDIO SECTION

Minimum RMS Output Power per Channel	
Front L, R	
8 ohms, 20 Hz to 20 kHz, 0.04% THD	70W+70W
Center	
8 ohms, 20 Hz to 20 kHz, 0.07% THD	70W
Rear L, R	
8 ohms, 1 kHz, 0.3% THD	20W+20W
Maximum Output Power	
[General model only]	
8 ohms, 1 kHz, 10% THD (FRONT L/R)	105W+105W
Dynamic Power per Channel	
(by IHF Dynamic Headroom measuring method)	
8/6/4/2 ohms	95/120/150/170W
DIN Standard Output Power per Channel	
4 ohms, 1 kHz, 0.7% THD	
[Europe model only]	100W
IEC Power	
8 ohms, 1 kHz, 0.1% THD	
[Europe model only]	78W
Power Band Width	
8 ohms, 30W, 0.08% THD	10 Hz to 50 kHz
Damping Factor (SPEAKERS A)	
8 ohms, 20 Hz to 20 kHz	80 or more
Input Sensitivity/Impedance	
PHONO MM	2.5 mV/47 k-ohms
CD/TAPE/TUNER/LD-TV/VCR	150 mV/47 k-ohms
Maximum Input Signal (1 kHz, 0.5% THD)	
PHONO MM	115 mV
CD/TAPE/TUNER/LD-TV/VCR (EFFECT ON)	2.2V
Output Level/Impedance	
REC OUT	150 mV/1.0 k-ohms
PRE OUT	2.2V/1.2 k-ohms
LPF (EFFECT OFF)	3.5V/1.5 k-ohms
Headphone Jack Rated Output/Impedance	
Output Level (8 ohms, 1 kHz, 150 mV)	0.5V
Impedance	390 ohms
Frequency Response (20 Hz to 20 kHz)	
CD/TAPE/TUNER/LD-TV/VCR (FRONT L/R)	0±0.5 dB
RIAA Equalization Deviation	
PHONO MM	0±0.5 dB
Total Harmonic Distortion	
PHONO MM to REC OUT	
20 Hz to 20 kHz, 1V	0.02% or less
CD/TAPE/TUNER/LD-TV/VCR to SP OUT	
FRONT L/R (EFFECT OFF)	
20 Hz to 20 kHz, 30W/8 ohms	0.02% or less
REAR L/R	
1 kHz, 10W/8 ohms	0.3% or less
Signal-to-Noise Ratio (IHF-A Network)	
PHONO MM to REC OUT (5 mV Input Shorted)	
[U.K. and Europe models]	82 dB
[Australia and General models]	85 dB
CD/TAPE/TUNER/LD-TV/VCR to SP OUT (Input Shorted, EFFECT OFF)	99 dB or more

Residual Noise (IHF-A Network)	
FRONT L/R	140 µV or less
Channel Separation	
(Vol. -30 dB, EFFECT OFF)	
PHONO MM	
(Input Shorted 1 kHz/10 kHz)	
	60 dB or more/50 dB or more
CD/TAPE/TUNER/LD-TV/VCR	
(Input 5.1 k-ohms Shorted 1 kHz/10 kHz)	
	60 dB or more/44 dB or more
Tone Control Characteristics	
BASS:	Boost/cut ±10 dB (50 Hz)
	Turnover Frequency (350 Hz)
TREBLE:	Boost/cut ±10 dB (20 kHz)
	Turnover Frequency (3.5 kHz)
Filter Characteristics	
LPF (fc=200 Hz)	6 dB/oct
Gain Tracking Error (0 to -60 dB)	3 dB or less

VIDEO SECTION

Video Signal Level	1 Vp-p/75 ohms
S-Video Signal Level	
Y	1 Vp-p/75 ohms
C	0.286 Vp-p/75 ohms
Maximum Input Level	1.5 Vp-p or more
Signal-to-Noise Ratio	50 dB or more
Monitor Out Frequency Response	5 Hz to 10 MHz, -3 dB

GENERAL

Power Supply	
[U.K. and Australia models]	AC 240V, 50 Hz
[Europe model]	AC 230V, 50 Hz
[General model]	AC 110/120/220/240V, 50/60 Hz
Power Consumption	300W
AC Outlets	
2 SWITCHED OUTLETS	
[Europe and General models]	120W max. total
1 SWITCHED OUTLET	
[U.K. and Australia models]	120W max. total
Dimensions (W x H x D)	435 x 146 x 386 mm
	(17-1/8" x 5-3/4" x 15-3/16")
Weight	10 kg (22 lbs. 0 oz.)
Accessories	Remote control transmitter Batteries

Specifications are subject to change without notice.

YAMAHA

YAMAHA ELECTRONICS CORPORATION, USA 6660 ORANGETHORPE AVE., BUENA PARK, CALIF. 90620, U.S.A.
YAMAHA CANADA MUSIC LTD. 135 MILNER AVE., SCARBOROUGH, ONTARIO M1S 3R1, CANADA
YAMAHA ELECTRONIK EUROPA G.m.b.H. SIEMENSSTR. 22-34, 25462 RELLINGEN BEI HAMBURG, F.R. OF GERMANY
YAMAHA ELECTRONIQUE FRANCE S.A. RUE AMBROISE CROIZAT BP70 CROISSY-BEAUBOURG 77312 MARNE-LA-VALLÉE CEDEX02, FRANCE
YAMAHA ELECTRONICS (UK) LTD. YAMAHA HOUSE, 200 RICKMANSWORTH ROAD WATFORD, HERTS WD1 7JS, ENGLAND
YAMAHA SCANDINAVIA A.B. J A WETTERGRENS GATA 1, BOX 30053, 400 43 VÄSTRA FRÖLUNDA, SWEDEN
YAMAHA MUSIC AUSTRALIA PTY, LTD. 17-33 MARKET ST., SOUTH MELBOURNE, 3205 VIC., AUSTRALIA

YAMAHA CORPORATION
VS73740