

YAMAHA PORTATONE

PSR-510

Owner's Manual



Wichtiger Hinweis für die Benutzung in der Bundesrepublik Deutschland.

Bescheinigung des Importeurs

Hiermit wird bescheinigt, daß der/die/das

Musikinstrument Typ: PSR-510

(Gerät, Typ, Bezeichnung)

in Übereinstimmung mit den Bestimmungen der

VERFÜGUNG 1046/84

(Amtsblattverfügung)

funk-entstört ist.

Der Deutschen Bundespost wurde das Inverkehrbringen dieses Gerätes angezeigt und die Berechtigung zur Überprüfung der Serie auf Einhaltung der Bestimmungen eingeräumt.

Yamaha Europa GmbH

Name des Importeurs

- This applies only to products distributed by Yamaha Europa GmbH.
- Dies bezieht sich nur auf die von der Yamaha Europa GmbH vertriebenen Produkte.

Entsorgung leerer Batterien (nur innerhalb Deutschlands)

Leisten Sie einen Beitrag zum Umweltschutz. Verbrauchte Batterien oder Akkumulatoren dürfen nicht in den Hausmüll. Sie können bei einer Sammelstelle für Altbatterien bzw. Sondermüll abgegeben werden. Informieren Sie sich bei Ihrer Kommune.

CANADA

THIS DIGITAL APPARATUS DOES NOT EXCEED THE "CLASS B" LIMITS FOR RADIO NOISE EMISSIONS FROM DIGITAL APPARATUS SET OUT IN THE RADIO INTERFERENCE REGULATION OF THE CANADIAN DEPARTMENT OF COMMUNICATIONS.

LE PRESENT APPAREIL NUMERIQUE N'EMET PAS DE BRUITS RADIOELECTRIQUES DEPASSANT LES LIMITES APPLICABLES AUX APPAREILS NUMERIQUES DE LA "CLASSE B" PRESCRITES DANS LE REGLEMENT SUR LE BROUILLAGE RADIOELECTRIQUE EDICTE PAR LE MINISTERE DES COMMUNICATIONS DU CANADA.

- This applies only to products distributed by Yamaha Canada Music Ltd.
- Ceci ne s'applique qu'aux produits distribués par Yamaha Canada Music Ltd.

The serial number of this product may be found on the bottom of the unit. You should note this serial number in the space provided below and retain this manual as a permanent record of your purchase to aid identification in the event of theft.

Model No. PSR-510

Serial No.

SPECIAL MESSAGE SECTION

This product utilizes batteries or an external power supply (adapter). DO NOT connect this product to any power supply or adapter other than one described in the manual, on the name plate, or specifically recommended by Yamaha.

This product should be used only with the components supplied or, a cart, rack, or stand that is recommended by Yamaha. If a cart, etc., is used, please observe all safety markings and instructions that accompany the accessory product.

SPECIFICATIONS SUBJECT TO CHANGE:

The information contained in this manual is believed to be correct at the time of printing. However, Yamaha reserves the right to change or modify any of the specifications without notice or obligation to update existing units.

This product, either alone or in combination with an amplifier and headphones or speaker/s, may be capable of producing sound levels that could cause permanent hearing loss. DO NOT operate for long periods of time at a high volume level or at a level that is uncomfortable. If you experience any hearing loss or ringing in the ears, you should consult an audiologist. **IMPORTANT:** The louder the sound, the shorter the time period before damage occurs.

NOTICE:

Service charges incurred due to a lack of knowledge relating to how a function or effect works (when the unit is operating as designed) are not covered by the manufacturer's warranty, and are therefore the owners responsibility. Please study this manual carefully and consult your dealer before requesting service.

ENVIRONMENTAL ISSUES:

Yamaha strives to produce products that are both user safe and environmentally friendly. We sincerely believe that our products and the production methods used to produce them, meet these goals. In keeping with both the letter and the spirit of the law, we want you to be aware of the following:

Battery Notice: This product MAY contain a small non-rechargeable battery

which (if applicable) is soldered in place. The average life span of this type of battery is approximately five years. When replacement becomes necessary, contact a qualified service representative to perform the replacement.

This product may also use "household" type batteries. Some of these may be rechargeable. Make sure that the battery being charged is a rechargeable type and that the charger is intended for the battery being charged.

When installing batteries, do not mix batteries with new, or with batteries of a different type. Batteries MUST be installed correctly. Mismatches or incorrect installation may result in overheating and battery case rupture.

Warning: Do not attempt to disassemble, or incinerate any battery. Keep all batteries away from children. Dispose of used batteries promptly and as regulated by the laws in your area. Note: Check with any retailer of household type batteries in your area for battery disposal information.

Disposal Notice: Should this product become damaged beyond repair, or for some reason its useful life is considered to be at an end, please observe all local, state, and federal regulations that relate to the disposal of products that contain lead, batteries, plastics, etc. If your dealer is unable to assist you, please contact Yamaha directly.

NAME PLATE LOCATION:

The name plate is located on the bottom of the product. The model number, serial number, power requirements, etc., are located on this plate. You should record the model number, serial number, and the date of purchase in the spaces provided below and retain this manual as a permanent record of your purchase.

Model

Serial No.

Purchase Date

PLEASE KEEP THIS MANUAL

FCC INFORMATION (U.S.A.)

IMPORTANT NOTICE: DO NOT MODIFY THIS UNIT!

This product, when installed as indicated in the instructions contained in this manual, meets FCC requirements. Modifications not expressly approved by Yamaha may void your authority, granted by the FCC, to use the product.

IMPORTANT: When connecting this product to accessories and/or another product use only high quality shielded cables. Cable/s supplied with this product MUST be used. Follow all installation instructions. Failure to follow instructions could void your FCC authorization to use this product in the USA.

NOTE: This product has been tested and found to comply with the requirements listed in FCC Regulations, Part 15 for Class "B" digital devices. Compliance with these requirements provides a reasonable level of assurance that your use of this product in a residential environment will not result in harmful interference with other electronic devices. This equipment generates/uses radio frequencies and, if not installed and used according to the instructions found in the users manual, may cause interference harmful to the operation of other electronic devices. Compliance with FCC regulations does not guaran-

tee that interference will not occur in all installations. If this product is found to be the source of interference, which can be determined by turning the unit "OFF" and "ON", please try to eliminate the problem by using one of the following measures:

- Relocate either this product or the device that is being affected by the interference.
- Utilize power outlets that are on different branch (circuit breaker or fuse) circuits or install AC line filter/s.
- In the case of radio or TV interference, relocate/reorient the antenna. If the antenna lead-in is 300 ohm ribbon lead, change the lead-in to co-axial type cable.

If these corrective measures do not produce satisfactory results, please contact the local retailer authorized to distribute this type of product. If you can not locate the appropriate retailer, please contact Yamaha Corporation of America, Electronic Service Division, 6600 Orangethorpe Ave, Buena Park, CA90620

- This applies only to products distributed by Yamaha Corporation of America.

Congratulations!

You are the proud owner of a Yamaha PSR-510. Your PSR-510 is a high-quality musical instrument that incorporates advanced Yamaha digital technology and many versatile features. In order to obtain maximum performance and enjoyment from your PSR-510, we urge you to read this Owner's Manual thoroughly while trying out the various features described. Keep the Owner's Manual in a safe place for later reference.

Contents

Panel Controls	2	Record Functions	37
Taking Care of Your PortaTone	4	Song Memory	37
Preparation	5	■ Realtime Accompaniment Track Recording	38
■ Power Supply	5	■ Realtime Melody Track Recording	40
■ Using Headphones Or an External Sound System	6	■ Accompaniment And Melody Playback	41
■ The Sustain Pedal	6	■ The [RESET] Button	42
■ The Music Stand	6	■ Record Or Play from a Specified Measure	42
Listen to the Demo!	7	The Multi Pads	43
Basic Editing Procedure	8	■ Realtime Recording	43
Selecting & Playing the Voices	10	■ Playback	44
■ Orchestration	10	Custom Accompaniment	45
■ Voice Assignment	12	■ Realtime Custom Accompaniment Recording	45
■ Volume	13	■ Using a Custom Accompaniment	47
■ Octave	13	Step Recording	48
■ DSP Depth	14	Editing Functions	48
■ Pan	14	■ Quantization	51
■ Auto Harmony	15	■ Clearing Tracks	52
■ Effects	16	■ Changing the Recorded Settings	52
■ Keyboard Percussion	17	Page Memory	54
■ Pitch Bend	18	MIDI	55
■ Sustain	18	MIDI Bulk Dump	56
Overall Control	19	■ Page Copy	57
■ Split Point Change	19	MIDI Reception Modes	58
■ Transpose	20	■ Channel Reception Modes	58
■ Tuning	20	■ Clock Mode	59
■ DSP Type	21	■ Start/Stop Mode	59
■ Touch Sensitivity	22	MIDI Transmission	60
Auto Accompaniment	23	■ MIDI Transmit Channels	60
■ Selecting a Style	23	■ Local & MIDI Output ON/OFF	60
■ Setting the Auto Accompaniment Split Point	24	Appendix	61
■ Auto Accompaniment Fingering	24	■ Voice & Polyphony List	61
■ Tempo Control	27	■ Style List	62
■ Accompaniment Control	28	■ Reset Procedures & Page Memory Default Settings	65
■ Accompaniment Volume	31	■ Troubleshooting	67
■ The Track Buttons	31	Index	68
■ Re-voicing the Tracks	32	Percussion Kit List	274
One Touch Setting	34	MIDI Implementation Chart	276
Registration Memory	35	Specifications	279

Top Panel Controls

- 1 POWER Button page 7
- 2 MASTER VOLUME Control page 7
- 3 MULTI DISPLAY page 7, 8
- 4 [+], [-] Buttons page 9
- 5 Number Buttons [0]~[9], [+/-] page 9
- 6 Data Dial page 9
- 7 ARE YOU SURE ? [YES], [NO] Buttons
..... page 46, 51, 52, 56, 57
- 8 PITCH BEND Wheel page 18
- 9 PAGE MEMORY Section
 - PAGE# Button page 54
 - MIDI BULK DUMP/PAGE COPY Button page 56, 57
- 10 OVERALL CONTROL Section
 - TEMPO Button page 27
 - METRONOME Button page 27
 - SPLIT POINT Button page 19
 - TRANSPOSE Button page 20
 - TUNING Button page 20
 - DSP TYPE Button page 21
 - TOUCH SENSE Button page 22
 - TOUCH RESPONSE Button page 22
- 11 MIDI Section
 - RECEIVE CH/CL/COM Button page 58, 59
 - TRANSMIT CH [L] Button page 60
 - LOCAL/MIDI OUT Button page 60
 - TRANSMIT CH [R] Button page 60
 - LOCAL/MIDI OUT Button page 60
- 12 AUTO ACCOMPANIMENT Section
 - STYLE SELECT Button page 23
 - AUTO ACCOMP Button page 24
 - FINGERING Button page 24
 - ACCOMP VOLUME Button page 31
 - REVOICE Button page 32
 - TRACK (RHYTHM1, 2, BASS, RHYTHMIC CHORD 1, 2, PAD CHORD, PHRASE1, 2) Buttons page 32, 46
- 13 ACCOMPANIMENT CONTROL Section
 - SYNC-START/STOP Button page 28
 - START/STOP Button page 28
 - FADE IN/OUT Button page 30
 - INTRO Button page 29
 - FILL IN 1 Button page 29
 - FILL IN 2 Button page 29
 - ENDING Button page 30
 - MAIN A/B Buttons page 29

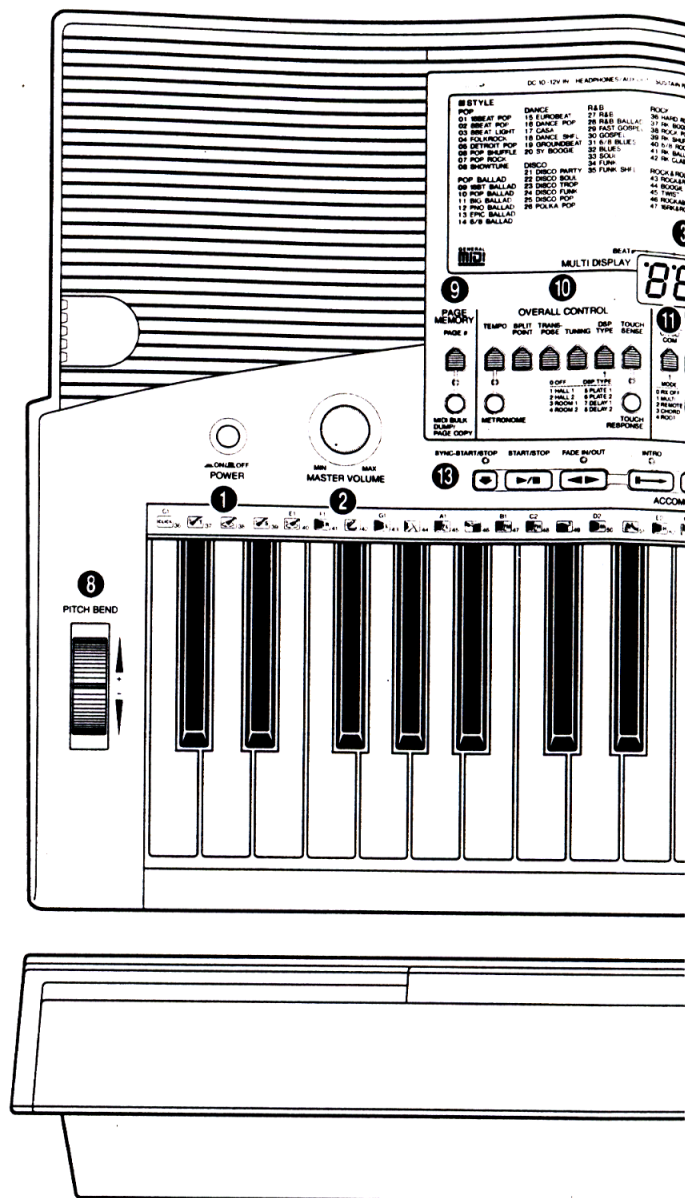

- 14 VOICE Section
 - VOICE SELECT Button page 12
 - KEYBOARD PERCUSSION Button page 17
 - VOL Button page 13
 - OCTAVE Button page 13
 - DSP DEPTH Button page 14
 - PAN Button page 14
 - ONE TOUCH SETTING Button page 34
 - ORCHESTRATION R1, R2, L1, L2, EDIT Buttons page 10, 11
 - HARMONY TYPE Button page 15
 - HARMONY Button page 15
 - EFFECT TYPE Button page 16
 - EFFECT Button page 16
- 15 REGISTRATION MEMORY Section
 - MEMORIZE Button page 35
 - [1]~[4] Buttons page 36
 - FREEZE Button page 36

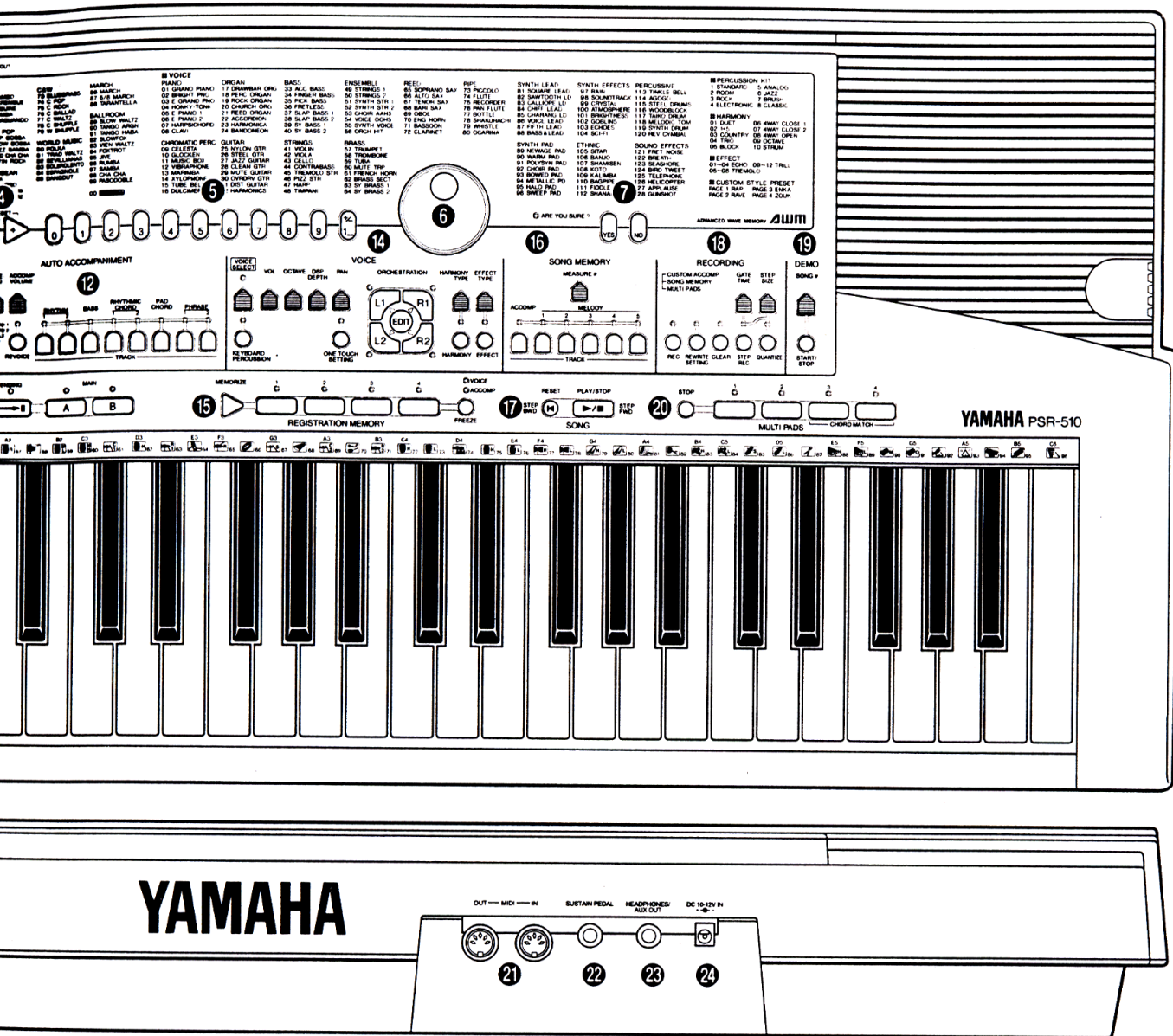

- 16** SONG MEMORY Section
 - MEASURE# Buttonpage 42
 - TRACK (ACCOMP, MELODY1~5) Buttonspage 38~41
- 17** SONG Section
 - RESET (STEP BWD) Buttonpage 42, 50
 - PLAY/STOP (STEP FWD) Buttonpage 50
- 18** RECORDING Section
 - REC Buttonpage 38, 40, 43, 46
 - REWRITE SETTING Buttonpage 52
 - CLEAR Buttonpage 52
 - GATE TIME Buttonpage 49
 - STEP REC Buttonpage 48
 - STEP SIZE Buttonpage 48
 - QUANTIZE Buttonpage 51

- 19** DEMO Section
 - SONG# Buttonpage 7
 - START/STOP Buttonpage 7
- 20** MULTI PADS Section
 - STOP Buttonpage 44
 - PAD [1]~[4] Buttonspage 43, 44

Rear Panel Controls

- 21** MIDI OUT and IN Connectorspage 55
- 22** SUSTAIN PEDAL Jackpage 6, 18
- 23** HEADPHONES/AUX OUT Jackpage 6
- 24** DC 10-12V IN Jackpage 5

Taking Care of Your PortaTone

Your PortaTone will give you years of playing pleasure if you follow the simple rules given below:

■ Location

Do not expose the instrument to the following conditions to avoid deformation, discoloration, or more serious damage.

- Direct sunlight (e.g. near a window).
- High temperatures (e.g. near a heat source, outside, or in a car during the daytime).
- Excessive humidity.
- Excessive dust.
- Strong vibration.

■ Power Supply

- Turn the power switch OFF when the instrument is not in use.
- A power adaptor, if used, should be unplugged from the AC outlet if the instrument is not to be used for an extended period of time.
- Unplug the power adaptor during electric storms.
- Avoid plugging the power adaptor into the same AC outlet as appliances with high power consumption, such as electric heaters or ovens. Also avoid using multi-plug adaptors since these can result in reduced sound quality and possibly damage.

■ Turn Power OFF When Making Connections

- To avoid damage to the instrument and other devices to which it is connected (a sound system, for example), turn the power switches of all related devices OFF prior to connecting or disconnecting audio and MIDI cables.

■ Handling and Transport

- Never apply excessive force to the controls, connectors or other parts of the instrument.
- Always unplug cables by gripping the plug firmly, not by pulling on the cable.
- Disconnect all cables before moving the instrument.
- Physical shocks caused by dropping, bumping, or placing heavy objects on the instrument can result in scratches and more serious damage.

■ Cleaning

- Clean the cabinet and panel with a dry soft cloth.
- A slightly damp cloth may be used to remove stubborn grime and dirt.
- Never use cleaners such as alcohol or thinner.
- Avoid placing vinyl objects on top of the instrument (vinyl can stick to and discolor the surface).

■ Electrical Interference

- This instrument contains digital circuitry and may cause interference if placed too close to radio or television receivers. If this occurs, move the instrument further away from the affected equipment.

■ Service and Modification

- The PSR-510 contains no user serviceable parts. Opening it or tampering with it in anyway can lead to irreparable damage and possibly electric shock. Refer all servicing to qualified YAMAHA personnel.

YAMAHA is not responsible for damage caused by improper handling or operation.

Preparation

This section contains information about setting up your PSR-510 and preparing to play. Be sure to go through this section carefully before using your PSR-510.

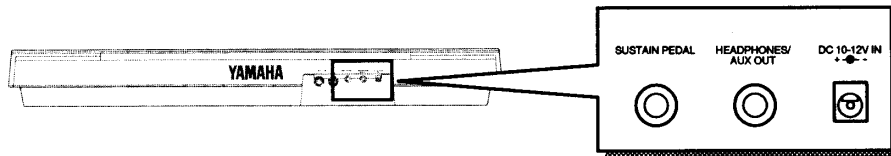

Power Supply

Your PSR-510 will run either from an optional power adaptor or batteries*. Follow the instructions below according to the power source you intend to use.

* When batteries are used the sound of the PSR-510 may be distorted at high volume levels. This is because the power of the amplifier is reduced when batteries are used.



• **Never interrupt the power supply (e.g. remove the batteries or unplug the AC adaptor) during any PSR-510 record operation! Doing so can result in a loss of data.**

● Using An Optional AC Power Adaptor

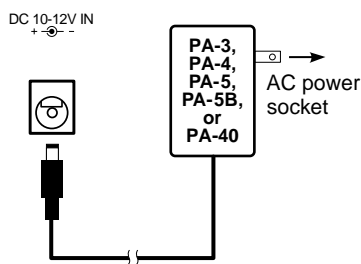

Plug the DC output cable from an optional Yamaha PA-3, PA-4, PA-5, PA-5B, or PA-40 AC Power Adaptor into the **DC IN** jack on the rear panel of the PSR-510, then plug the Power Adaptor (or the AC cable of the Power Adaptor) into a convenient wall AC power socket. The internal batteries are automatically disconnected when an AC Power Adaptor is used.



• **Use ONLY a Yamaha PA-3, PA-4, PA-5, PA-5B, or PA-40 AC Power Adaptor to power your instrument from the AC mains. The use of other adaptors may result in irreparable damage to both the adaptor and the PSR-510.**



• **Using the PA-5 with the PSR-510 will provide a slight increase in the overall volume.**

● Using Batteries

For battery operation the PSR-510 requires six 1.5V SUM-1, “D” size, R-20 or equivalent batteries.

When the batteries need to be replaced the volume may be reduced, the sound may be distorted, and other problems may occur. When this happens, turn the power off while either the batteries are replaced or an AC adaptor is connected.

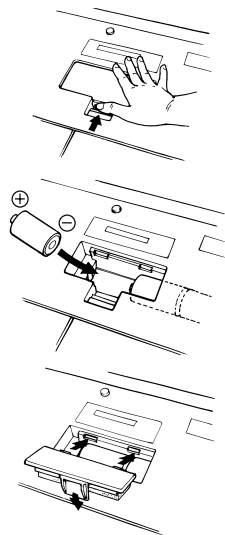

When the batteries fail, replace them as follows:

- 1 Open the battery compartment cover located on the instrument’s bottom panel.
- 2 Insert the six new batteries, being careful to follow the polarity markings on the inside of the compartment.
- 3 Replace the compartment cover, making sure that it locks firmly in place.



• **When the batteries run down, replace them with a complete set of six new batteries. NEVER mix old and new batteries.**

• **Do not use different kinds of batteries (e.g. alkaline and manganese) at the same time.**

• **To prevent possible damage due to battery leakage, remove the batteries from the instrument if it is not to be used for an extended period of time.**

Preparation

■ Using Headphones Or an External Sound System

HEADPHONES/
AUX OUT

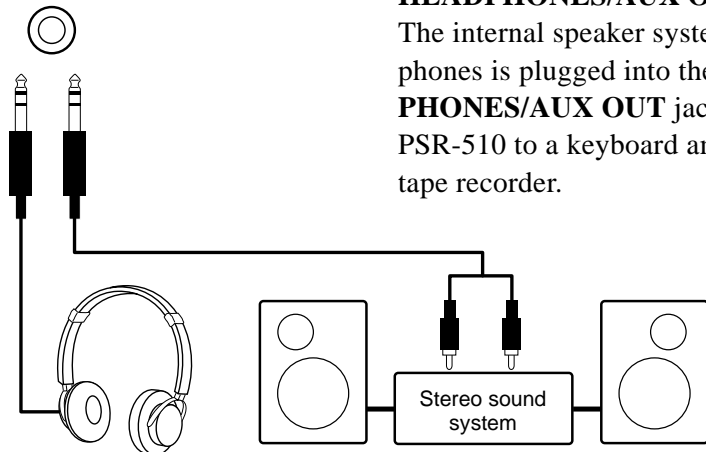

A standard pair of stereo headphones can be plugged into the rear-panel **HEADPHONES/AUX OUT** jack for private practice or late-night playing. The internal speaker system is automatically shut off when a pair of headphones is plugged into the **HEADPHONES/AUX OUT** jack. The **HEADPHONES/AUX OUT** jack can also be used to deliver the output of the PSR-510 to a keyboard amplifier, stereo sound system, mixing console or tape recorder.

■ The Sustain Pedal

SUSTAIN PEDAL

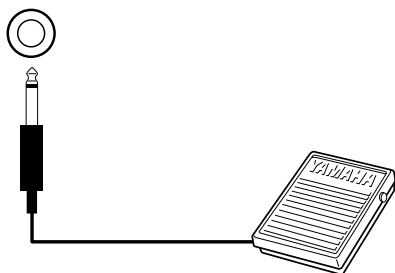

An optional Yamaha FC4 or FC5 footswitch can be plugged into the rear-panel **SUSTAIN PEDAL** jack. The sustain pedal functions as a damper pedal, controlling sustain. Press the pedal to sustain notes after the keys are released.



- ***Be sure that you do not press the pedal while inserting the plug into the SUSTAIN PEDAL jack or while turning the power on. If you do, the ON/OFF status of the footswitch will be reversed. This function has been implemented to allow either press-to-make or press-to-break contact type footswitches to be used with the PSR-510.***

■ The Music Stand

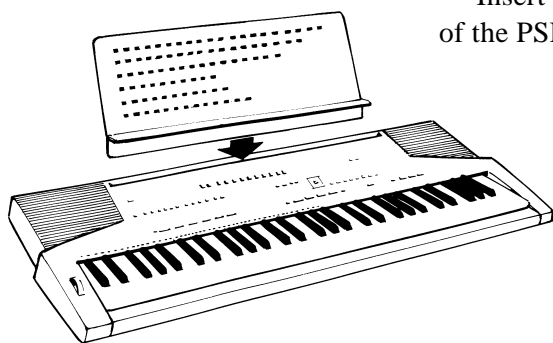

Insert the bottom edge of the music stand into the slot located at the rear of the PSR-510 control panel.

Listen to the Demo!

Once you've set up your PSR-510, try listening to the pre-programmed demonstration songs — they'll give you a good idea of what the PSR-510 can do!

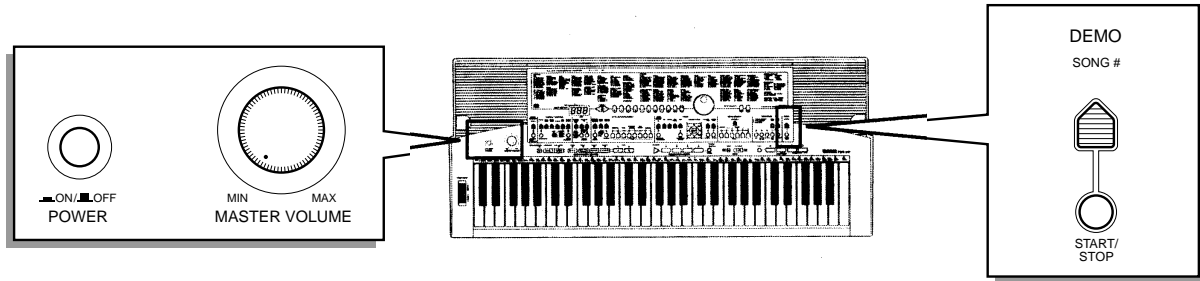

1 Turn the Power ON & Set the Volume

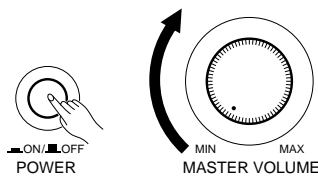

Before playing the demo turn the power ON by pressing the **POWER** switch (the panel indicators and MULTI DISPLAY will light), and turn the **MASTER VOLUME** control up (clockwise) about a quarter-turn from its minimum position.

2 Select a Song

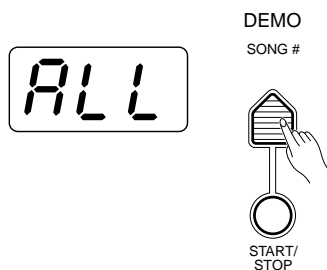

Press the DEMO [SONG #] button a few times until the number of the desired demo song appears on the MULTI DISPLAY.

ALL (0): Repeat playback of all demo songs in sequence.

1-6: Repeat playback of the selected demo song number.



• "ALL" is automatically selected whenever the power switch is turned on.

3 Press DEMO [START/STOP] to Start

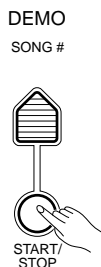

Press the DEMO [START/STOP] button to start playback, and use the MASTER VOLUME control to set the ideal listening level. The selected demonstration will play repeatedly.



• During demo playback you can select different voices and play along on the keyboard — see the "Selecting & Playing the Voices" section beginning on page 10.

4 Press DEMO [START/STOP] to Stop

Press the DEMO [START/STOP] button again to stop demo playback.

Basic Editing Procedure

The PSR-510 features a flexible-but-consistent interface that lets you edit just about all of its parameters using the same basic procedure. Once familiar with the system, you'll be able to edit any parameter quickly and easily. Here's the basic procedure:

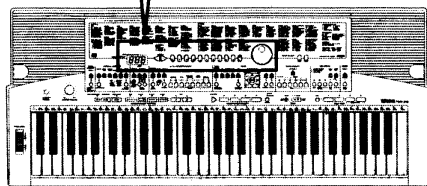
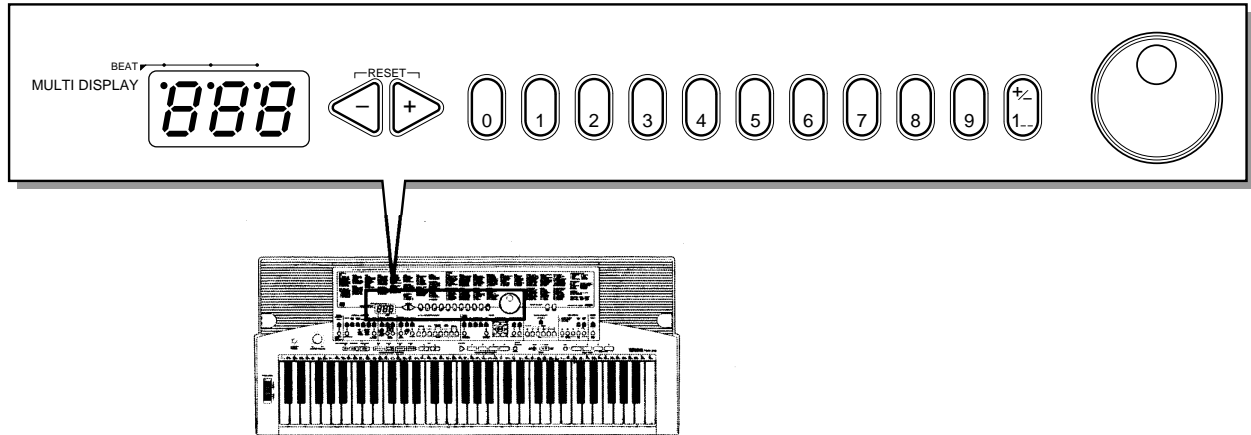

1 Press a Function Button

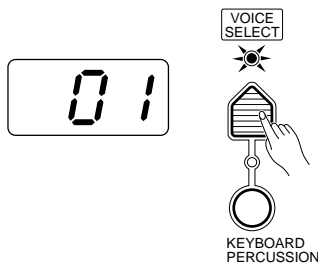

First press the button corresponding to the function or parameter you want to edit. To select voice numbers, for example, press the [VOICE SELECT] button (its indicator will light). The number shown on the MULTI DISPLAY will be the current value of the selected parameter.

2 Edit the Parameter

The PSR-510 lets you edit parameters using four different methods. Use the one that best suits the parameter you have selected:

2-1: The Function Button

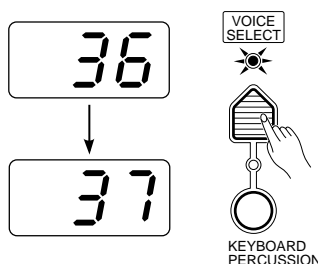

Each time you press a function button (except for the SPLIT POINT button) after initially selecting the function, the value of the corresponding parameter will be incremented (increased) by one. If you hold the function button for a few seconds, the parameter will begin to increment continuously as long as you hold the button.

If, for example, you press the [VOICE SELECT] button and MULTI DISPLAY shows that voice number 36 is currently selected, you can select voice number 37 simply by pressing the [VOICE SELECT] button again.

2-2: The [+] and [-] Buttons

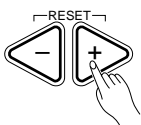

The [+] and [-] buttons immediately to the right of the MULTI DISPLAY can be used to increment (increase by one) or decrement (decrease by one) the currently selected parameter. Press the [+] button briefly to increment the parameter value, or the [-] button to decrement. If you hold the [+] or [-] button down, the value will increment or decrement continuously — simply release the button when the desired value has been reached.

2-3: The Number Buttons

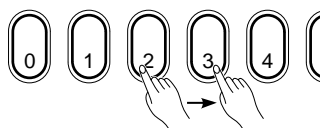

The number buttons — to the right of the [+] and [-] buttons — allow direct numeric entry of the desired value, and are therefore the fastest way to edit in many situations.

To select a voice, for example, choose one of the 128 voices — numbered “01” through “128” — shown on the panel VOICE list, then enter its number using the number buttons. To select “HARMONICA” (number 23), for example, first press [2] then [3]. The number “23” should then appear on the MULTI DISPLAY.

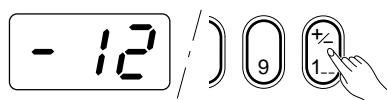

The [+/-] button is used to switch between positive and negative values with parameters that allow negative values (Transpose, Tuning, Octave, and Pan, for example). A “-” appears before negative values on the MULTI DISPLAY.

When selecting voice numbers the [+/-] button is used to enter the hundreds digit of the voice number (the button alternately selects no hundreds digit or “1”), as required, prior to entering the tens and ones digits. The [1] number button cannot be used to enter the hundreds digit when selecting voices.

Values outside the range of the selected parameter can not be entered.

2-4: The Data Dial



- After editing a parameter other than [VOICE SELECT], the [VOICE SELECT] parameter will automatically be re-selected after a brief delay.
- If you attempt to change a parameter that can not be edited in the current mode, “---” will appear on the MULTI DISPLAY.

● Yes/No Confirmation



Some operations that change important settings or erase data may require you to confirm your choice by pressing the [YES] or [NO] button. When a choice needs to be confirmed the ARE YOU SURE? indicator will flash and a digitally sampled voice will ask “Are you sure?”. Press the [YES] button to execute the specified operation or the [NO] button to cancel and leave the settings or data unaffected.

If you don't want to hear the “Are you sure?” confirmation sound, hold down the [NO] button while initially turning the power switch on. To restore the confirmation sound, turn the power switch off, then turn it back on again while holding down the [YES] button. The on/off status of the confirmation sound is retained in memory even when the power switch is turned off as long as batteries are installed on an AC adaptor is connected.

Selecting & Playing the Voices

The PSR-510 has 128 stunning voices plus 8 different drum and percussion kits that you can select and play in a number of ways.

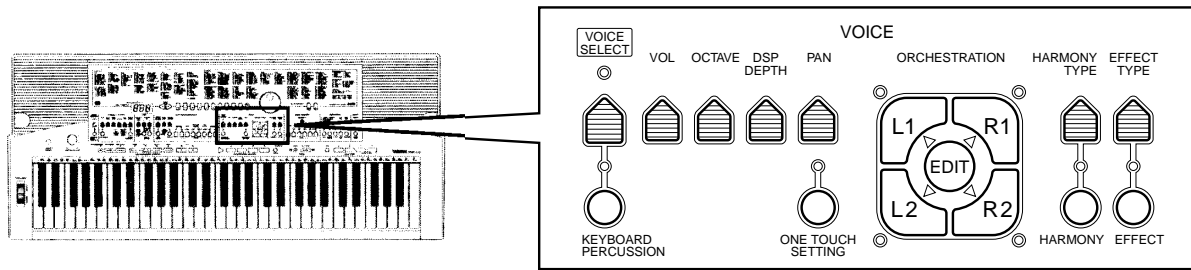

Orchestration

The unique ORCHESTRATION button group in the PSR-510's VOICE control section lets you select and play from one to four "parts" at the same time using a variety of "orchestrations". One of the PSR-510's 128 voices is assigned to each part.

- **Single:** One voice over the entire keyboard.
- **Dual:** Two voices simultaneously over the entire keyboard.
- **Split:** Different voices with the left and right hands.
- **Split & Dual:** Combinations of the Split and Dual modes.

There are actually a number of variations on each of the above orchestrations. The ORCHESTRATION buttons are used to choose the type of orchestration you want.

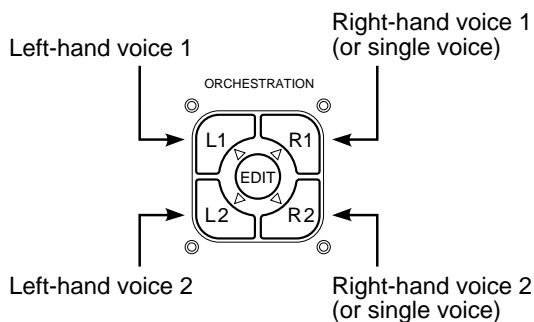

The four available parts are turned on and off by the [R1], [R2], [L1], and [L2] buttons. The indicators next to each of these buttons tell you which parts are on and which are off, and therefore indicate the current orchestration mode. The [EDIT] button determines which of the four orchestration parts is to be edited. You can, for example, assign any of the PSR-510's 128 voices to each of the orchestration parts. But before we discuss voice assignment and editing, let's take a look at the various orchestration modes:

Single Modes

In the "single" modes either the [R1] or [R2] part voice can be played over the entire keyboard. The R1 and R2 single-voice modes are selected simply by pressing either the [R1] or [R2] button if neither the [L1] or [L2] indicators are lit. If the [L1] and/or [L2] indicators are lit, press them so that both indicators go out.

Note that when you select the [R1] or [R2] single-voice mode, the triangular EDIT indicator for the selected voice also lights. This means you can select a different voice number or otherwise edit the current voice using the procedures described on page 12.



The R1 voice is played across the entire keyboard.

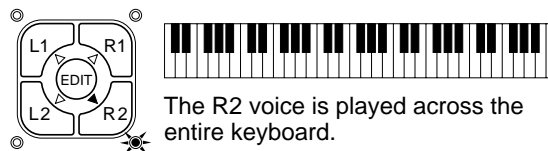

The R2 voice is played across the entire keyboard.

● Dual Mode

In the dual mode both the **[R1]** and **[R2]** part voices are selected so they can be played simultaneously across the entire keyboard. To select the dual mode, make sure that both the **[L1]** and **[L2]** indicators are out, then press both the **[R1]** and **[R2]** buttons simultaneously (or hold one while pressing the other).

You can switch back to either of the single modes from the dual mode simply by pressing the **[R1]** or **[R2]** button, as required.

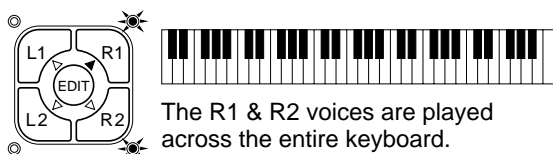

● Split Modes

The PSR-510 allows four different split modes, with one voice played on the left-hand section of the keyboard (**[L1]** or **[L2]**) and a different voice on the right-hand section of the keyboard (**[R1]** or **[R2]**). Selecting a split mode is simply a matter of pressing the buttons corresponding to the desired left- and right-hand parts.

The split point (i.e. the key at which the voices change over) can be set at any desired key by using the SPLIT POINT CHANGE function described on page 19.

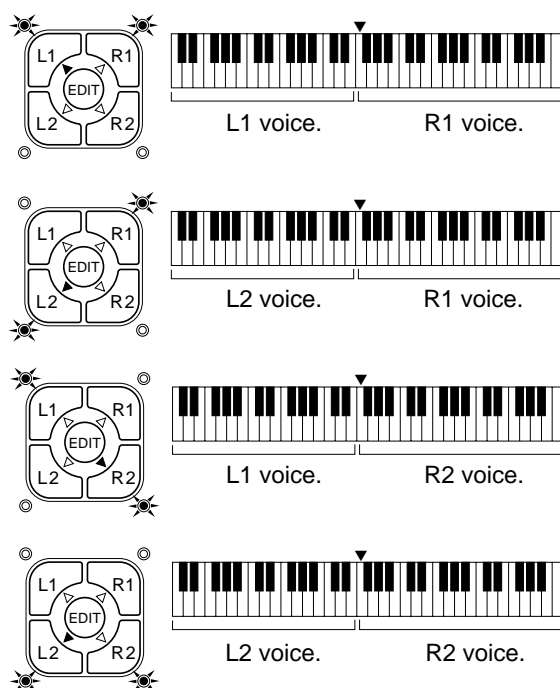

● Split & Dual Modes

There are five possible combinations of the split and dual modes, as shown below. The part for the single-voice side of the combination is selected simply by pressing the appropriate part button, while for the dual-voice side both buttons must be pressed simultaneously (or one while holding the other).

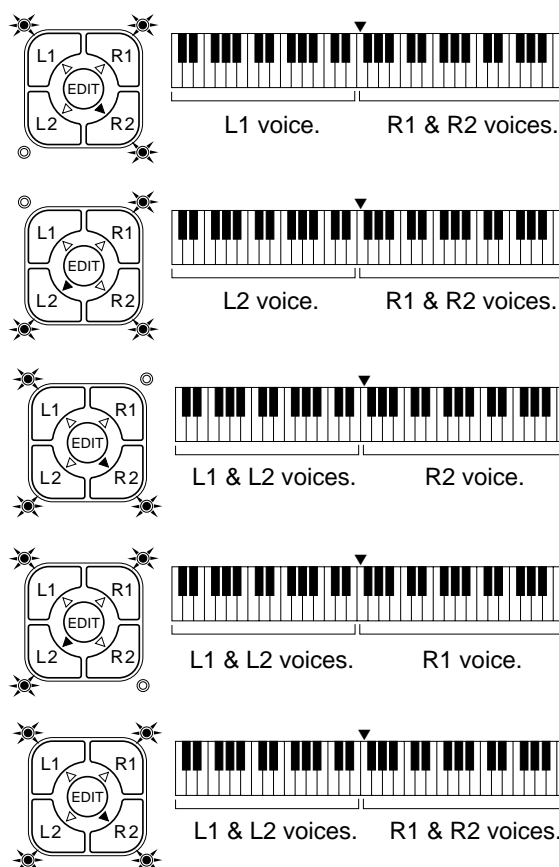

Selecting & Playing the Voices

Voice Assignment

You can assign any of the PSR-510's 128 voices to each of the ORCHESTRATION parts, whether the part is currently ON or OFF.

1 Press the [VOICE SELECT] Button

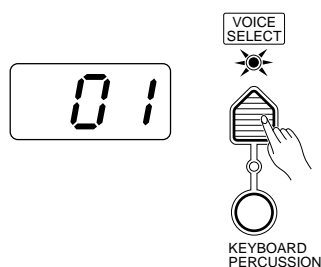

You don't need to do this if the [VOICE SELECT] indicator is already lit. Also make sure that the [KEYBOARD PERCUSSION] indicator is out.

2 Select the Part You Want to Edit



Use the ORCHESTRATION [EDIT] button to select the part to which you want to assign a new voice. The [EDIT] indicators light in sequence in the clockwise direction each time the [EDIT] button is pressed.

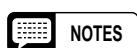

- You can edit the voice number of a part that is OFF while playing a different part.
- Actually, the [VOICE SELECT] mode is automatically selected whenever the [EDIT] button is pressed, so you don't really need to press [VOICE SELECT] as described in step 1 if you're going to use the [EDIT] button prior to selecting a voice number.

3 Select a Voice Number

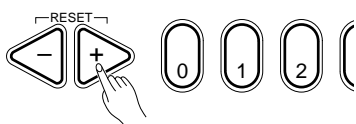

Referring to the VOICE list printed on the PSR-510 panel, use the [+] and [-] buttons, the number buttons, the data dial, or the [VOICE SELECT] button itself to select the required voice number (see page 8 for editing procedure details).

Example: Voice number "120"

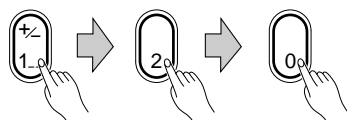

When entering voice numbers higher than 99, use the [+/-] button to enter the hundreds digit prior to entering the tens and ones digits: the button alternately selects no hundreds digit or "1".



- The optimum keyboard range is preset for each voice.

Volume

You can individually set the volume of each orchestration part to set up the ideal balance between parts.

1 Select the Part You Want to Edit

Use the ORCHESTRATION [EDIT] button to select the part you want to edit.

2 Press the [VOL] Button

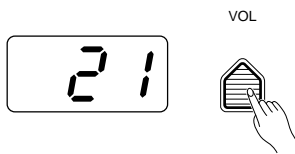

Press the VOICE control section [VOL] button. The current volume value of the selected part will appear on the MULTI DISPLAY.

3 Set the Volume

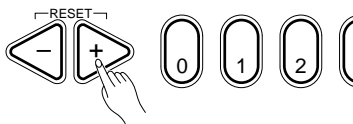

Use the [+] and [-] buttons, the number buttons, the data dial, or the [VOL] button itself to set the desired volume. The volume range is from 00 (no sound) to 24 (maximum volume). The default volume value (21) can be recalled instantly by pressing both the [+] and [-] buttons at the same time.

Octave

You can individually shift the octave of each orchestration part up or down by up to two octaves. This makes it easy, for example, to lower the pitch of a bass voice to an appropriate octave without affecting the other parts in your orchestration.

1 Select the Part You Want to Edit

Use the ORCHESTRATION [EDIT] button to select the part you want to edit.

2 Press the [OCTAVE] Button

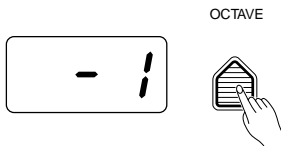

Press the VOICE control section [OCTAVE] button. The current octave value of the selected part will appear on the MULTI DISPLAY.

3 Set the Octave

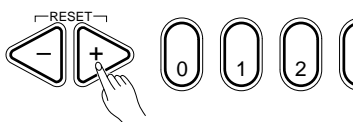

Use the [+] and [-] buttons, the number buttons, the data dial, or the [OCTAVE] button itself to set the desired octave. The octave range is from -2 (down two octaves) to +2 (up two octaves). The normal octave value for the selected voice can be recalled instantly by pressing both the [+] and [-] buttons at the same time.

Selecting & Playing the Voices

DSP Depth

The PSR-510 features a built-in digital signal processor (DSP) that can be used to apply a range of reverb and delay effects to the PSR-510 voices. The [DSP TYPE] button in the OVERALL CONTROL section (page 21) determines the type of effect to be applied, while the VOICE section [DSP DEPTH] button lets you individually set the amount of effect applied to each orchestration part.

1 Select the Part You Want to Edit

Use the ORCHESTRATION [EDIT] button to select the part you want to edit.

2 Press the [DSP DEPTH] Button



Press the VOICE control section [DSP DEPTH] button. The current DSP depth value of the selected part will appear on the MULTI DISPLAY.

3 Set the DSP Depth

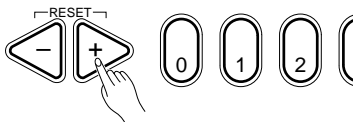

Use the [+] and [-] buttons, the number buttons, the data dial, or the [DSP DEPTH] button itself to set the desired DSP depth. The depth range is from **00** (no effect, direct sound only) to **15** (maximum effect).

The default DSP depth value (06) can be recalled instantly by pressing both the [+] and [-] buttons at the same time.

Pan

The PSR-510 delivers true stereo sound, and you can use this parameter to individually set the stereo (pan) position of each orchestration part to create a broad stereo image of your sound.

1 Select the Part You Want to Edit

Use the ORCHESTRATION [EDIT] button to select the part you want to edit.

2 Press the [PAN] Button

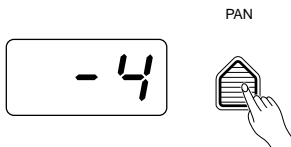

Press the VOICE control section [PAN] button. The current pan value of the selected part will appear on the MULTI DISPLAY.

3 Set the Pan Position

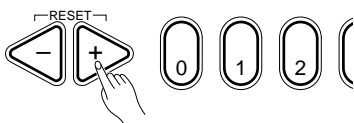

Use the [+] and [-] buttons, the number buttons, the data dial, or the [PAN] button itself to set the desired pan value. The pan range is from **-7** (full left) to **+7** (full right). A setting of “0” places the sound of the selected part in the center of the stereo sound field. Other settings produce in-between positions. “-4”, for example, would place the sound between center and full left.

The center pan position (0) can be recalled instantly by pressing both the [+] and [-] buttons at the same time.



• The new pan value will apply from the next note played — i.e. you can't pan the sound of a note while it is playing.

■ Auto Harmony

Auto Harmony is used with the PSR-510's Auto Accompaniment feature except for Full fingering mode (see page 23). It automatically adds appropriate harmony notes to a single-note melody line you play on the keyboard. You can choose from 10 different types of harmony that can be assigned to the right-hand orchestration parts.

1 Turn Auto Harmony ON

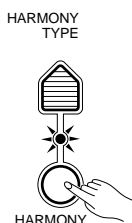

Press the **[HARMONY]** button so that its indicator lights. This turns Auto Harmony ON.



- The HARMONY can't be engaged when Keyboard Percussion is ON.

2 Press the [HARMONY TYPE] Button

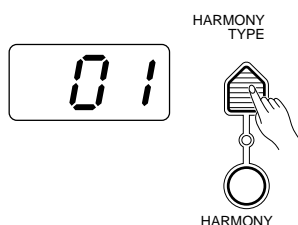

Press the VOICE control section **[HARMONY TYPE]** button. The number of the currently selected harmony type will appear on the MULTI DISPLAY.

3 Select a Harmony Type

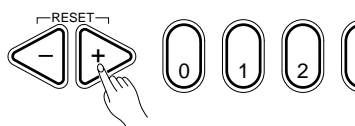

Use the **[+]** and **[-]** buttons, the number buttons, the data dial, or the **[HARMONY TYPE]** button itself to select the desired effect.

The Harmony Types

01	Duet	06	4-way close 1
02	1 + 5	07	4-way close 2
03	Country	08	4-way open
04	Trio	09	Octave
05	Block	10	Strum

4 Turn Auto Harmony ON or OFF as Required

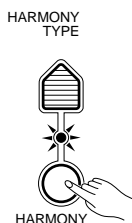

Use the **[HARMONY]** button to turn Auto Harmony ON or OFF. Auto Harmony is ON when the **[HARMONY]** button indicator is lit.



- When Auto Harmony is used in the dual mode, the R1 voice responds to notes played on the keyboard while the harmony notes are played by the R1 and R2 voices, depending on the selected harmony type.
- Only a single note can be played at a time on the keyboard (or the right-hand section of the keyboard) when the Auto Harmony feature is used.
- If you play more than one note at the same time while Auto Harmony is ON, only the highest note will sound.
- Auto Harmony will only function when the Auto Accompaniment function is being used (page 23).

Selecting & Playing the Voices

Effects

The PSR-510 has a range of 12 delay-based effects — in addition to the DSP effects (pages 14 and 21) — that can be selected and applied to the right-hand orchestration parts (the left-hand orchestration parts are not affected).

1 Turn the Effect ON

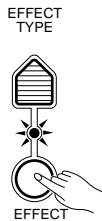

Press the [EFFECT] button so that its indicator lights. This turns ON the effect.



• The EFFECT can't be engaged when Keyboard Percussion is ON.

2 Press the [EFFECT TYPE] Button

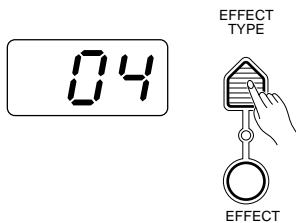

Press the VOICE control section [EFFECT TYPE] button. The number of the currently selected effect will appear on the MULTI DISPLAY.

3 Select an Effect

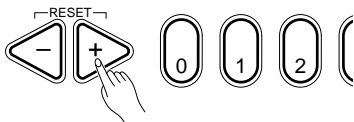

Use the [+] and [-] buttons, the number buttons, the data dial, or the [EFFECT TYPE] button itself to select the desired effect.

The Effects

01	Echo		05	Tremolo		09	Trill	
02	Echo		06	Tremolo		10	Trill	
03	Echo		07	Tremolo		11	Trill	
04	Echo		08	Tremolo		12	Trill	

4 Turn the Effect ON or OFF as Required

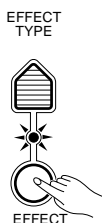

Use the [EFFECT] button to turn the effect ON or OFF. The selected effect is ON when the [EFFECT] button indicator is lit.



• You can change the effect type whether the effect is ON or OFF.

Keyboard Percussion

The PSR-510 has 8 different drum and percussion “kits” that can be played on the keyboard when the Keyboard Percussion function is turned ON. The types of drum and percussion instruments played by the various keys when Keyboard Percussion function is selected are marked by symbols above the keys.

1 Turn Keyboard Percussion ON

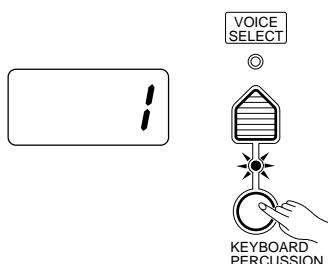

Press the **[KEYBOARD PERCUSSION]** button so that its indicator lights to turn Keyboard Percussion ON. The percussion kit number will appear on the MULTI DISPLAY.

2 Select a Percussion Kit

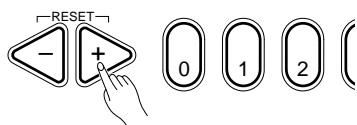

Use the [+] and [-] buttons, the number buttons, the data dial, or the **[VOICE SELECT]** button to select the desired percussion kit (1 through 8). See page 274 for a complete list of the percussion kit instruments.

The Percussion Kits

1	Standard
2	Room
3	Rock
4	Electronic
5	Analog
6	Jazz
7	Brush
8	Classic

NOTES

- The *HARMONY*, *EFFECT* and *TRANSPOSE* functions (pages 15, 16 and 20) do not affect the percussion sounds. The *HARMONY* and *EFFECT* functions will be canceled when Keyboard Percussion is turned ON.
- The *ORCHESTRATION [EDIT]* button does not function when Keyboard Percussion is turned ON.

Selecting & Playing the Voices

■ Pitch Bend



The **PITCH BEND** wheel to the left of the keyboard allows the note pitch to be bent up or down — roll the wheel away from you to bend up, and toward you to bend down (this situation can be reversed, as described below). When the **PITCH BEND** wheel is moved almost all the way in either direction, the current pitch bend range value will appear on the **MULTI DISPLAY** (see below).

● Setting the Pitch Bend Range

The maximum amount of pitch bend produced by the **PITCH BEND** wheel can be set anywhere from ± 1 semitone to ± 12 semitones (i.e. plus or minus one octave).

1 Call the Pitch Bend Range Parameter

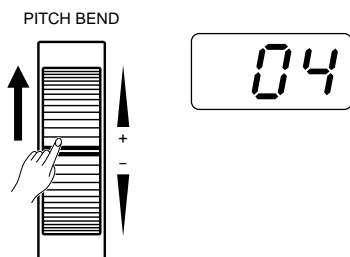

To set the pitch bend range, roll the **PITCH BEND** wheel all the way in either direction so that the current range value appears on the **MULTI DISPLAY**.

2 Set the Pitch Bend Range

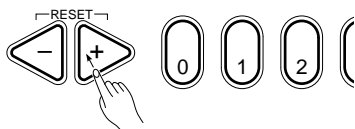

While holding the **PITCH BEND** wheel at its maximum position, use the **[+]** and **[-]** buttons, the number buttons, or the data dial to select the desired pitch bend range. The pitch bend range value is displayed in semitones (-12 through 12). If a minus setting is selected pitch bend wheel operation is reversed — i.e. roll the wheel away from you to lower pitch. The default pitch bend range (02) can be instantly recalled by pressing **[+]** and **[-]** buttons simultaneously.

3 Release the PITCH BEND Wheel

Release the **PITCH BEND** wheel when you've set the required pitch bend range.

■ Sustain

SUSTAIN PEDAL

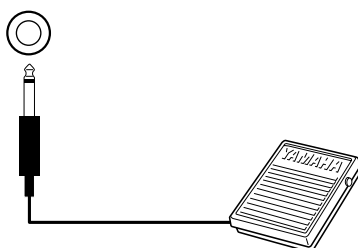

If you have plugged an optional Yamaha FC4 or FC5 footswitch into the PSR-510's rear-panel **SUSTAIN PEDAL** jack, the footswitch can be used as a damper pedal, controlling sustain. Press the pedal to sustain notes after the keys are released.

Overall Control

The OVERALL CONTROL section includes a range of parameters that, as their title suggests, apply to the overall sound of the PSR-510.

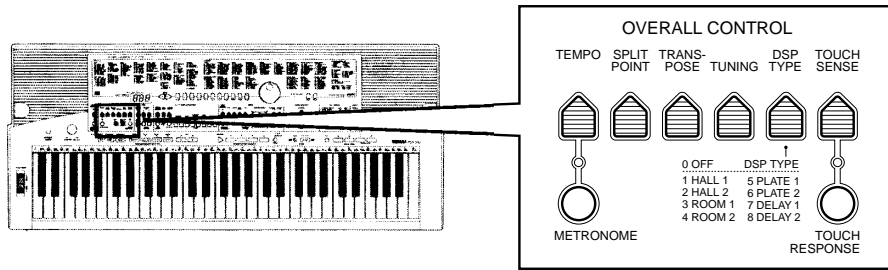

Split Point Change

This function lets you set the split point (the key that separates the left-hand and right-hand orchestration parts) to any key on the keyboard.

1 Turn Auto Accompaniment OFF

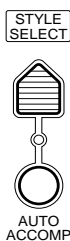

To set the split point for the left- and right-hand orchestration parts, make sure that the [AUTO ACCOMP] indicator is off before proceeding.



- The PSR-510 actually memorizes two separate split points: one for the left- and right-hand orchestration parts, and one for Auto Accompaniment mode. See page 24 for details on setting the Auto Accompaniment split point.

2 Press the [SPLIT POINT] Button



Press the OVERALL CONTROL section [SPLIT POINT] button. The key number of the current split point will appear on the MULTI DISPLAY.



- The key numbers for each note are listed above the keyboard. The C3 (middle C) key number, for example, is 60.

3 Set the Split Point

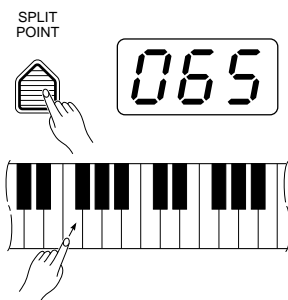

The easiest way to set the split point is to press the key you want to set as the split point while holding the [SPLIT POINT] button. The number of the selected key will appear on the MULTI DISPLAY.

As with all other parameters, you can also use the [+] and [-] buttons, the number buttons, or the data dial to select the desired split point. The default split point (69) can be recalled instantly by pressing both the [+] and [-] buttons at the same time.



- The split-point key becomes the lowest key in the right-hand section of the keyboard.

Overall Control

Transpose

The PSR-510 [TRANPOSE] button makes it possible to shift the pitch of the PSR-510 up or down in semitone intervals up to a maximum of 12 semitones (one octave). Transposing the pitch of the PSR-510 keyboard makes it easier to play in difficult key signatures, and you can easily match the pitch of the keyboard to the range of a singer or other instrumentalist.

1 Press the [TRANPOSE] Button

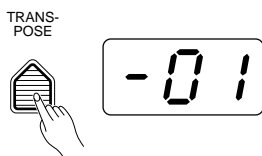

Press the OVERALL CONTROL section [TRANPOSE] button. The current transpose value will appear on the MULTI DISPLAY.

2 Set the Desired Degree of Transposition

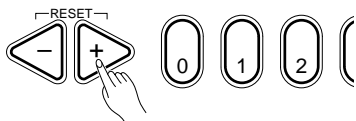

Use the [+] and [-] buttons, the number buttons, the data dial, or the [TRANPOSE] button itself to set the desired degree of transposition.

The transposition range is from **-12** to **+12**, with **-12** corresponding to downward transposition by 12 semitones (one octave), and **+12** corresponding to upward transposition by 12 semitones. **00** is the “normal” keyboard pitch value. The normal transpose value (**00**) can be recalled instantly by pressing both the [+] and [-] buttons at the same time.



• The new transpose value will apply from the next note played — i.e. you can't transpose the sound of a note while it is playing.

Tuning

The PSR-510 [TUNING] button makes it possible to tune the pitch of the PSR-510 to match other instruments. Tuning can be accomplished over a ± 50 -cent range (that's 100 cents total, or one semitone) in 33 steps.

1 Press the [TUNING] Button

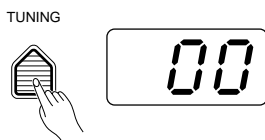

Press the OVERALL CONTROL section [TUNING] button. The current tuning value will appear on the MULTI DISPLAY.

2 Set the Tuning

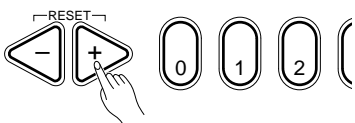

Use the [+] and [-] buttons, the number buttons, the data dial, or the [TUNING] button itself to set the desired tuning value.

The tuning range is from **-16** (-50 cents) to **+16** (+50 cents). “**00**” (± 0 cents) is the “normal” tuning value. The normal tuning value (**00**) can be recalled instantly by pressing both the [+] and [-] buttons at the same time.



• The tuning setting is retained in memory even when the power switch is turned off, as long as batteries are installed or an AC adaptor is connected.

DSP Type

The [DSP TYPE] button selects one of eight digital effects that you can use for extra depth and expressive power. This button determines the type of effect to be used, while the [DSP DEPTH] button in the VOICE section allow the depth of the effect to be individually set for each orchestration part.

1 Press the [DSP TYPE] Button

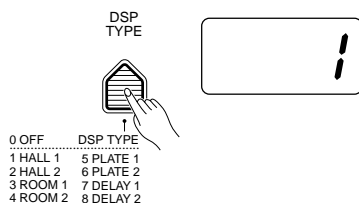

Press the OVERALL CONTROL section [DSP TYPE] button. The number of the current DSP type will appear on the MULTI DISPLAY.

2 Select a DSP Type

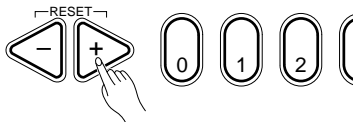

Use the [+] and [-] buttons, the number buttons, the data dial, or the [DSP TYPE] button itself to select the desired DSP type (0 for OFF, or 1 ... 8 as listed below). The default DSP type (1) can be recalled instantly by pressing both the [+] and [-] buttons at the same time.

The DSP Types

1	Hall 1	For a spacious reverb sound use one of the Hall settings. These effects simulate the natural reverberation of a concert hall. Hall 2 has a longer reverb time and therefore simulates a larger hall than Hall 1.
2	Hall 2	
3	Room 1	These settings add relatively short reverb effects to the sound that are similar to the type of acoustic reverberation you might hear in different rooms.
4	Room 2	
5	Plate 1	These are simulations of the large plate reverb devices traditionally used in professional recording studios.
6	Plate 2	
7	Delay 1	Delay 1 produces a distinct series of delay repeats, while Delay 2 produces a smoother multiple-delay sound.
8	Delay 2	

NOTES

- DSP effects may sound different with different voices.
- The DSP type setting is retained in memory even when the power switch is turned off, as long as batteries are installed or an AC adaptor is connected.

Overall Control

■ Touch Sensitivity

This function varies the touch sensitivity of the keyboard. Use this capability to adjust the PSR-510's touch sensitivity for the best results with your own particular playing style.

1 Press the [TOUCH SENSE] Button

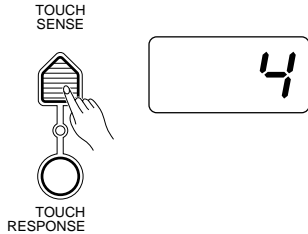

Press the OVERALL CONTROL section [TOUCH SENSE] button. The current sensitivity setting will appear on the MULTI DISPLAY.

2 Turn Touch Sensitivity ON

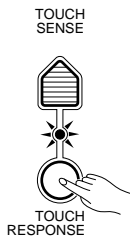

Press the [TOUCH RESPONSE] button so that its indicator lights. This turns touch sensitivity ON.

3 Set the Sensitivity

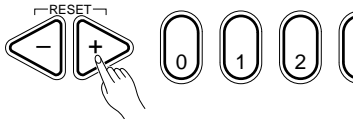

Use the [+] and [-] buttons, the number buttons, the data dial, or the [TOUCH SENSE] button itself to set the desired sensitivity value (1 ... 5).

A setting of “1” produces the least touch sensitivity, and therefore the smallest dynamic range. A setting of “5” produces the greatest sensitivity and broadest dynamic range. The default touch sensitivity value (4) can be recalled instantly by pressing both the [+] and [-] buttons at the same time.

4 Turn Touch Sensitivity ON or OFF as Required

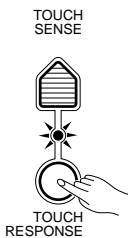

Use the [TOUCH RESPONSE] button to turn touch sensitivity ON or OFF as required. When OFF (i.e. when the indicator is off) the same volume is produced no matter how hard you play on the keyboard. Touch sensitivity can be turned OFF to produce a more realistic effect with voices that normally do not have touch response: e.g. organ and harpsichord.

Auto Accompaniment

The PSR-510 has 103 accompaniment styles that can be used to provide fully-orchestrated Auto Accompaniment.

When the Auto Accompaniment function is turned ON, the PSR-510 creates fully-orchestrated rhythm, bass, and chord accompaniment based on chords you play with the left hand in the Auto Accompaniment section of the keyboard (i.e. all keys to the left of the Auto Accompaniment split point). The right-hand section of the keyboard is available for normal playing.

The default Auto Accompaniment split point is the G2 (55) key. The Auto Accompaniment section of the keyboard consists of all keys to its left. The Auto Accompaniment split point can be set to any other key as described in "Setting the Auto Accompaniment Split Point" on page 24.

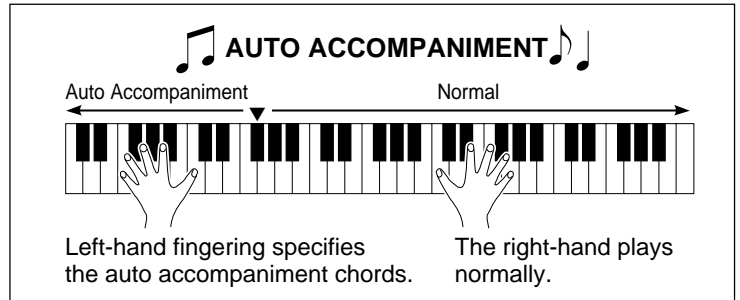

NOTES

- The PSR-510 also has a special "Full" Auto Accompaniment fingering mode in which chords played anywhere on the keyboard determine the Auto Accompaniment chords. See page 27 for details.

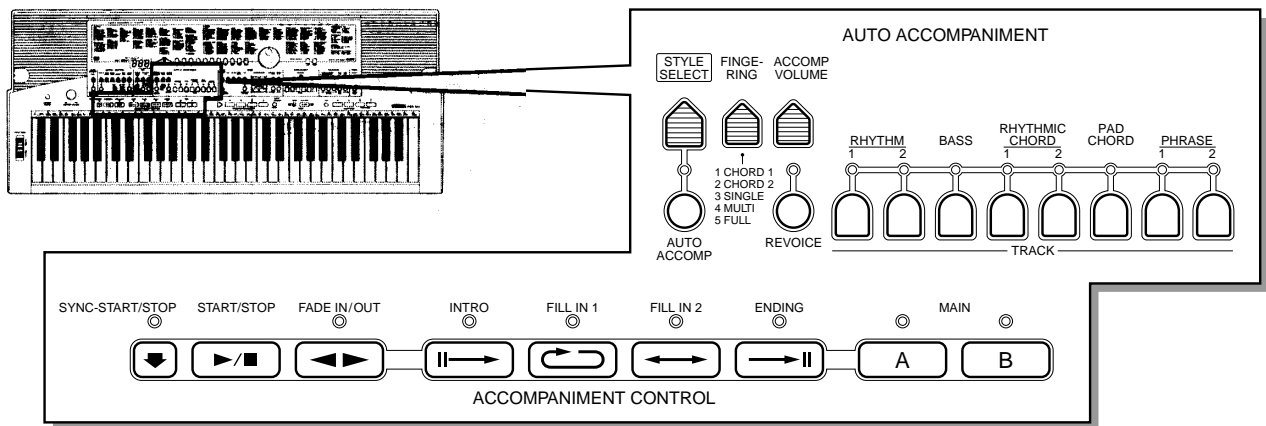

Selecting a Style

Any of the PSR-510's 103 accompaniment styles can be selected via the normal editing procedure. This can be done either before or during accompaniment playback. See page 62 for descriptions of all 103 styles.

1 Press the [STYLE SELECT] Button

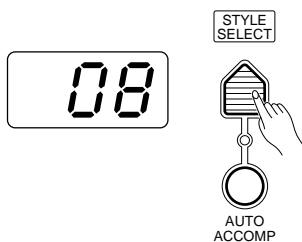

When you press the [STYLE SELECT] button the currently selected style number will appear on the MULTI DISPLAY.

2 Select a Style Number

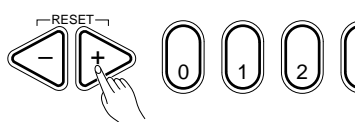

Referring to the STYLE list printed on the PSR-510 panel, use the [+] and [-] buttons, the number buttons, the data dial, or the [STYLE SELECT] button itself to select the required style number (see page 8 for editing procedure details).

Auto Accompaniment

■ Setting the Auto Accompaniment Split Point

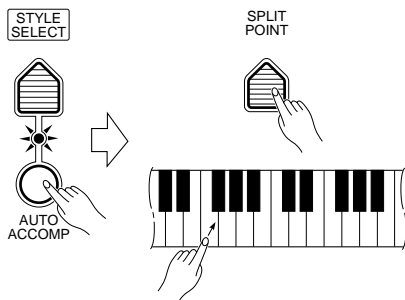

To set the Auto Accompaniment split point, first turn Auto Accompaniment ON — press the [AUTO ACCOMP] button so that its indicator lights — then proceed with steps 2 and 3 as described in “Split Point Change” on page 19. The default Auto Accompaniment split point (55) can be recalled instantly by pressing both the [+] and [-] buttons at the same time.

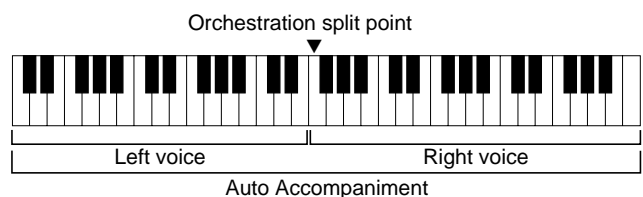
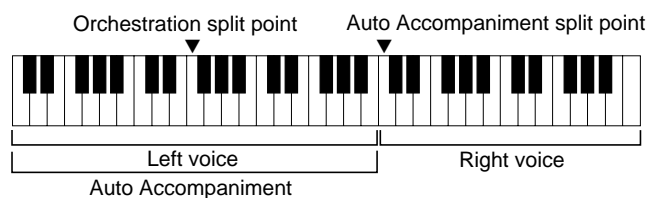
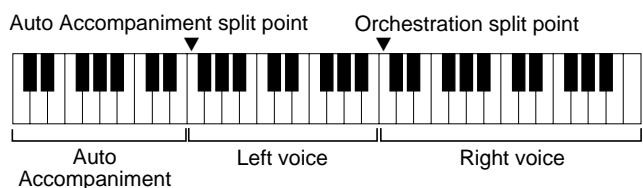

NOTES

- If the Auto Accompaniment split point is set at a lower key than the orchestration split point, the L1 and/or L2 voice will sound between the Auto Accompaniment and orchestration split points.
- If the Auto Accompaniment split point is set at a higher key than the orchestration split point, the L1 and/or L2 voice will sound throughout the entire Auto Accompaniment section.
- If the Auto Accompaniment “Full” fingering mode is selected, the L1 and/or L2 voice will sound to the left of the orchestration split point while the R1 and/or R2 voice will sound to the right of the orchestration split point.

■ Auto Accompaniment Fingering

The PSR-510 has 5 Auto Accompaniment fingering modes, selected via the [FINGERING] button.

1 Press the [FINGERING] Button



When you press the [FINGERING] button the currently selected Auto Accompaniment fingering number will appear on the MULTI DISPLAY.

2 Select a Fingering Mode

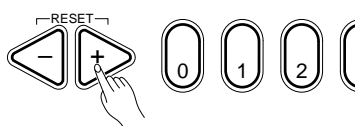

Use the [+] and [-] buttons, the number buttons, the data dial, or the [FINGERING] button itself to select the required fingering mode (see page 8 for editing procedure details).

● **Mode 1: Chord 1**



The Chord 1 mode is ideal if you already know how to play chords on a keyboard, since it allows you to supply your own chords for the Auto Accompaniment feature.

The PSR-510 will accept the following chord types:

Example for “C” chords

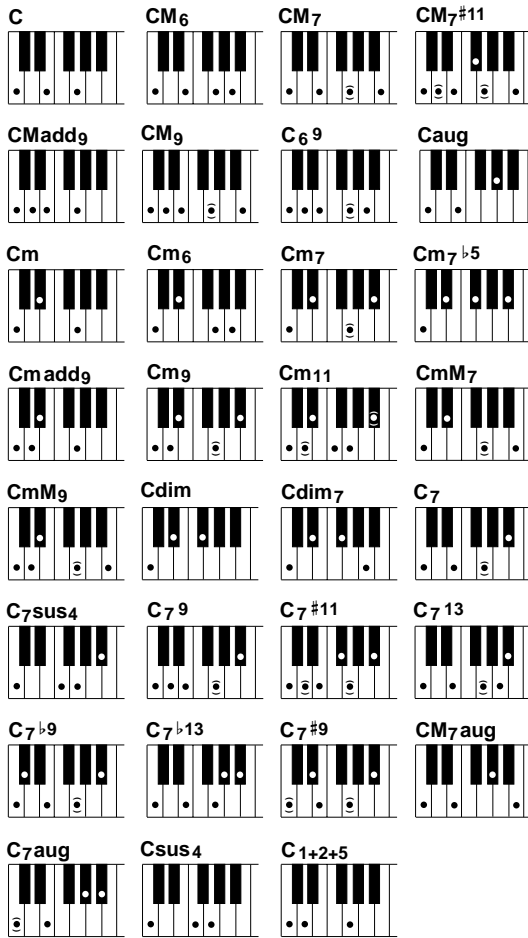

Major [M]	1 - 3 - 5
Major sixth [M6]	1 - 3 - 5 - 6
Major seventh [M7]	1 - 3 - (5) - 7
Major seventh sharp eleventh [M7#11]	..	1 - (2) - 3 - #4 - (5) - 7
Major add ninth [Madd9]	1 - 2 - 3 - 5
Major ninth [M9]	1 - 2 - 3 - (5) - 7
Major sixth add ninth [6 9]	1 - 2 - 3 - (5) - 6
Augmented [aug]	1 - 3 - #5
Minor [m]	1 - b3 - 5
Minor sixth [m6]	1 - b3 - 5 - 6
Minor seventh [m7]	1 - b3 - (5) - b7
Minor seventh flatted fifth [m7b5]	1 - b3 - b5 - b7
Minor add ninth [madd9]	1 - 2 - b3 - 5
Minor ninth [m9]	1 - 2 - b3 - (5) - b7
Minor eleventh [m11]	1 - (2) - b3 - 4 - 5 - (b7)
Minor major seventh [mM7]	1 - b3 - (5) - 7
Minor major ninth [mM9]	1 - 2 - b3 - (5) - 7
Diminished [dim]	1 - b3 - b5
Diminished seventh [dim7]	1 - b3 - b5 - 6
Seventh [7]	1 - 3 - (5) - b7
Seventh suspended fourth [7sus4]	1 - 4 - 5 - b7
Seventh ninth [7 9]	1 - 2 - 3 - (5) - b7
Seventh sharp eleventh [7#11]	1 - (2) - 3 - #4 - (5) - b7
Seventh thirteenth [7 13]	1 - 3 - (5) - 6 - b7 or 2 - 3 - 5 - 6 - b7
Seventh flatted ninth [7b9]	1 - b2 - 3 - (5) - b7
Seventh flatted thirteenth [7b13]	1 - 3 - 5 - b6 - b7
Seventh sharp ninth [7#9]	(1) - #2 - 3 - (5) - b7
Major seventh augmented [M7aug]	1 - 3 - #5 - 7
Seventh augmented [7aug]	(1) - 3 - #5 - b7
Suspended fourth [sus4]	1 - 4 - 5
One plus two plus five [1+2+5]	1 - 2 - 5

NOTES

- Notes in parentheses can be omitted.
- A perfect fifth produces accompaniment based only on the root and fifth which can be used with many major and minor chords.
- An octave produces accompaniment based only on the root.
- If three adjacent keys are played simultaneously (white and black keys), chord accompaniment will be cancelled and only the rhythm accompaniment will sound. (Chord 1/Chord 2 mode)
- The chord fingerings listed are all in “root position”, but other inversions can be used — with the following exceptions:
 - * M6 chords are only recognized in root position. All other inversions are interpreted as m7.

- * 6 9 chords are only recognized in root position. All other inversions are interpreted as m11.
- * m6 chords are only recognized in root position. All other inversions are interpreted as m7b5.
- * 1+2+5 chords are only recognized in root position. All other inversions are interpreted as sus4.
- * With aug and dim7 chords the lowest note played is assumed to be the root.
- * With 7#11 chords the lowest note played is assumed to be the root or b7.

Auto Accompaniment

● Mode 2: Chord 2

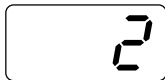

This is essentially the same as the Chord 1 mode, above, except that the lowest note played in the Auto Accompaniment section of the keyboard will be played by the bass part rather than the chord root.



● Mode 3: Single

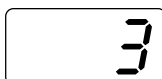

SINGLE mode fingering makes it simple to produce beautifully orchestrated accompaniment using major, seventh, minor and minor-seventh chords by pressing a minimum number of keys in the Auto Accompaniment section of the keyboard. The accompaniment produced is perfectly matched to the currently selected accompaniment style.



Major Chords:

If you press a “C” key in the left-hand section of the keyboard, for example, a C-major accompaniment will be played. Press another key in the left-hand section of the keyboard to select a new chord. The key you press will always determine the “root” of the chord played (i.e. “C” for a C chord).

Minor Chords:

Simultaneously press the root key and a black key to its left.

Seventh Chords:

Simultaneously press the root key and a white key to its left.

Minor-seventh Chords:

Simultaneously press the root key and both a white and black key to its left.



- The Auto Accompaniment will continue playing even if you lift your fingers from the Auto Accompaniment keys. You only need to press the Auto Accompaniment keys when changing chords.

● Mode 4: Multi

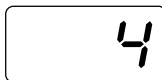

This is a combination of the Single and Chord 1 modes. In this mode the PSR-510 automatically discriminates between Single and Chord 1 mode fingerings and generates the appropriate accompaniment.



- If more than two keys are played and all but the highest key are black keys, and the chord is not recognized by the Chord 1 mode, the highest note will be interpreted as the root of a minor (m) chord.
- If more than three keys are played and, excluding the highest key, are a mixture of black and white keys, and the chord is not recognized by the Chord 1 mode, the highest note will be interpreted as the root of a minor-seventh (m7) chord.
- If more than two keys are played and all but the highest key are white keys, and the chord is not recognized by the Chord 1 mode, the highest note will be interpreted as the root of a seventh (7) chord.



● Mode 5: Full

In this mode chords played anywhere on the keyboard are detected and used for Auto Accompaniment. Otherwise the keyboard functions normally, and the entire range is available for playing. Chord recognition is the same as in the Chord 1 mode. Please note that in this mode all notes you play on the keyboard at any one time will be interpreted as the Auto Accompaniment chord.



- A single note one octave lower than the lowest note of the chord is recognized as a bass note, and a single note eleven notes upper is recognized as a melody note.

Stop Accompaniment function

Chords played in the Auto Accompaniment section of the keyboard are also detected and played by the PSR-510 Auto Accompaniment system when the accompaniment is stopped (except for Full fingering mode). In this case the bass note and chord voices are selected automatically.

■ Tempo Control

The [TEMPO] button can be used to control the tempo of AUTO ACCOMPANIMENT, SONG MEMORY, and MULTI PAD playback (see pages 41 and 44 respectively).

1 Press the [TEMPO] Button

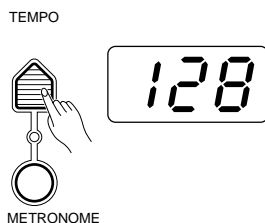

Press the OVERALL CONTROL section [TEMPO] button. The current tempo (beats per minute) will appear on the MULTI DISPLAY.

2 Set the Tempo

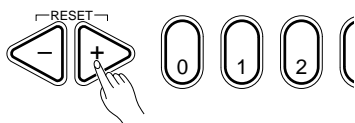

Use the [+] and [-] buttons, the number buttons, the data dial, or the [TEMPO] button itself to set the desired tempo.

The available tempo range is from **040** to **240** beats per minute. Each accompaniment style has a different “default” tempo which is automatically set whenever a new style is selected (but not when a new style is selected while the accompaniment is playing). The default tempo for the currently selected accompaniment style can be recalled instantly by pressing both the [+] and [-] buttons at the same time.

● The [METRONOME] Button

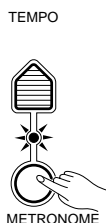

The PSR-510 includes a metronome function that you’ll use primarily with the recording functions described on page 37. If you press the [METRONOME] button so that its indicator lights when using Auto Accompaniment, the metronome will sound at the currently set tempo when the synchro-start mode is engaged, and while the accompaniment is playing.

Auto Accompaniment

Accompaniment Control

The PSR-510 provides a range of accompaniment “sections” — introduction, fill-ins, variations on the main pattern, ending — that you can select to control the “flow” of the accompaniment to achieve the desired musical results. Accompaniment start/stop and sections are controlled by the ACCOMPANIMENT CONTROL buttons.

● Straight Start



The [START/STOP] button starts the selected accompaniment style immediately.

Press the [AUTO ACCOMP] button so that its indicator lights before starting the accompaniment. The accompaniment will start with the rhythm sound only when the [START/STOP] button is pressed, then the bass and chord parts will begin playing as soon as the first note or chord is played on the Auto Accompaniment section of the keyboard.



- A different accompaniment style can be selected at any time while the accompaniment is playing. The style number on the MULTI DISPLAY will change as soon as the selection is made, but the new style will begin playback from the top of the next measure. The only exception is if you change styles while an intro is playing (see page 29), in which case the new style begins playing after the intro has finished. The tempo will not change when the new style begins playing.

4/4 time

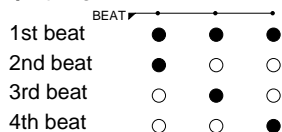

3/4 time

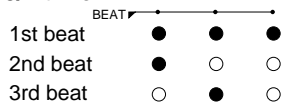

6/8 time

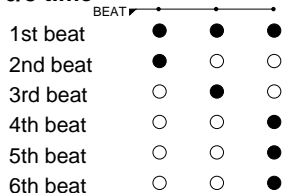

The Beat Indicator

The three BEAT indicator dots along the top of the MULTI DISPLAY flash to indicate the tempo and beat as the accompaniment plays. All three dots flash together on the first beat of each measure, then the dots flash individually in sequence on the remaining beats. In 4/4, 3/4, and 6/8 time, for example, the beat indicator dots will flash as shown to the left.



- Each accompaniment style has a preset “normal” tempo which is automatically selected whenever the style is selected while the accompaniment is stopped. The current tempo is maintained if you select a different style during accompaniment playback (excepting the playback by One Touch settings). You can change the tempo as required by using the TEMPO function described on page 27.

● Synchro Start

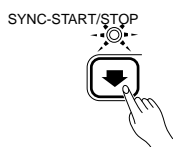

Press the [SYNC-START/STOP] button if you want the accompaniment to start when you play the first note or chord on the keyboard. In this case the accompaniment is started by playing in the left-hand section of the keyboard.



- If the AUTO ACCOMP mode is OFF, playing anywhere on the keyboard causes the rhythm-only accompaniment to start.

If you press the [SYNC-START/STOP] button, the BEAT indicator dots will flash at the current tempo. The synchro start mode can be disengaged by pressing the [SYNC-START/STOP] button again so that its indicator goes out.

● Starting the Accompaniment with an Introduction

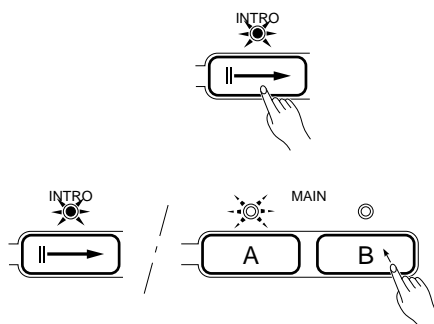

Any of the PSR-510 accompaniment patterns can be started with an appropriate introduction by pressing the [INTRO] button and then the [START/STOP] button.

Once the [INTRO] button is pressed, the [INTRO] indicator will be lit continuously and the MAIN [A] or [B] indicator will flash to indicate which section will play when the introduction has finished. You can change the “destination” section by pressing the MAIN [A] or [B] button while its indicator is flashing. When the introduction ends, the [INTRO] indicator will go out and the [A] or [B] indicator will light continuously.

NOTES

- It is possible to start the accompaniment from any section — even the ending — by pressing the corresponding button prior to pressing the [START/STOP] button. The destination MAIN [A] or [B] section can be selected as described above.
- The [INTRO] button can be used to select the introduction pattern even while the accompaniment is playing.
- If you press the [SYNC-START/STOP] button and then the [INTRO] button, the accompaniment will start from the introduction as soon as a chord is detected in the Auto Accompaniment section of the keyboard.

● The MAIN [A] and [B] Sections

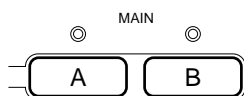

Each accompaniment style has two main sections — [A] and [B]. If the MAIN [A] or [B] button is pressed while the accompaniment is playing, the corresponding section will begin from the top of the next measure. You can also select [A] or [B] before starting the accompaniment.

NOTES

- The MAIN [A] section is automatically selected whenever the power switch is turned on.

● Adding Fill-ins

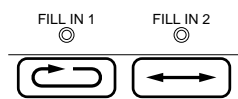

The PSR-510 provide two types of fill-ins (rhythmic variations) — one which plays and then returns to the current MAIN section, and one which leads to the other MAIN section. Press the [FILL IN 1] button at any time while the accompaniment is playing to add a one-measure fill-in and or return to the current MAIN section, or press the [FILL IN 2] button to add a one-measure fill-in and go to the other MAIN section.

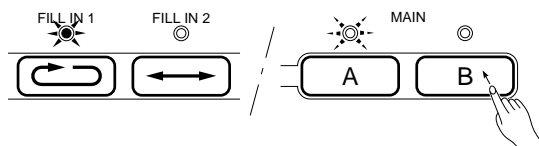

If the MAIN A section is playing, for example, the [A] indicator will flash while FILL IN 1 plays, and the [B] indicator will flash while FILL IN 2 plays. You can change the section that will begin playing after the fill-in by pressing the desired section button while the indicator is still flashing.

NOTES

- If you hold the [FILL IN 1] or [FILL IN 2] button, the fill-in pattern will repeat until the button is released, then the MAIN A or B section will play from the beginning of the next measure.
- If the [FILL IN 1] or [FILL IN 2] button is pressed after the last beat of a measure, the fill-in will begin from the first beat of the next measure. If pressed at any other time the fill-in will begin immediately.
- It is also possible to start the accompaniment with a fill-in by pressing the desired FILL IN button prior to pressing the [START/STOP] button. The destination MAIN [A] or [B] section can be selected in the normal way.

Auto Accompaniment

● Stopping the Accompaniment.....



An accompaniment in progress can be stopped immediately by pressing the **[START/STOP]** button or the **[SYNC-START/STOP]** button. In the latter case the synchro start mode will be engaged when the accompaniment stops. The accompaniment can also be stopped with an appropriate ending by pressing the **[ENDING]** button.



- The ending will begin from the first beat of the next measure.
- If the **[FILL IN 1]** or **[FILL IN 2]** button is pressed while the ending pattern is playing, a fill-in will be played, followed by a return to the **MAIN A** or **B** pattern.

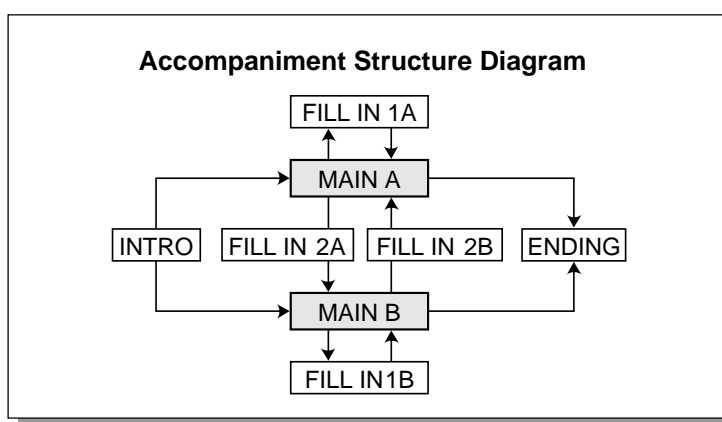

● Fade In & Fade Out.....

The **[FADE IN/OUT]** button can be used to produce smooth accompaniment and melody fade-ins or fade-outs.

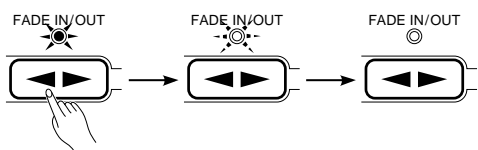

Start Playback with a Fade-in

You can start the accompaniment with a fade-in by pressing the **[FADE-IN/OUT]** button before starting playback. The **[FADE-IN/OUT]** button indicator will light continuously until the accompaniment is started. The fade-in will begin automatically as soon as the accompaniment is started. The **[FADE-IN/OUT]** button indicator will flash during the fade-in, and will go out when the fade-in is complete.

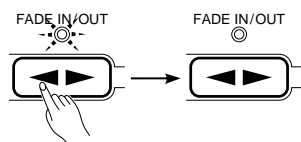

Fade-out to stop the accompaniment during Playback

Press the **[FADE-IN/OUT]** button during accompaniment playback to fade out the accompaniment and melody sound. The **[FADE-IN/OUT]** button indicator will flash during the fade-out, and will go out when the fade-out is complete.

■ Accompaniment Volume

While the VOICE control section [VOL] button can be used to set the volume levels of the orchestration parts, the [ACCOMP VOLUME] button can be used to adjust the volume of the selected accompaniment in relation to the voices.

1 Press the [ACCOMP VOLUME] Button

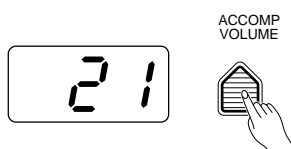

Press the AUTO ACCOMPANIMENT control section [ACCOMP VOLUME] button. The current accompaniment volume value will appear on the MULTI DISPLAY.

2 Set the Volume

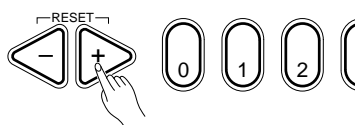

Use the [+] and [-] buttons, the number buttons, the data dial, or the [ACCOMP VOLUME] button itself to set the desired volume. The volume range is from 00 (no sound) to 24 (maximum volume). The default volume value (21) can be recalled instantly by pressing both the [+] and [-] buttons at the same time.

■ The Track Buttons

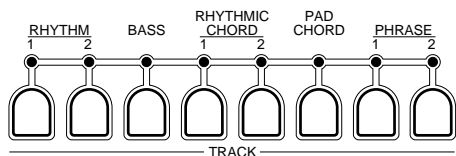

The PSR-510 Auto Accompaniment system includes eight TRACK buttons which allow you to control the accompaniment arrangement in real time. You can turn tracks on or off while playing for extra accompaniment variety.

The various tracks are turned on or off by pressing the corresponding TRACK button. When a part is turned off the corresponding indicator will go out. To silence the bass part, for example, press the TRACK [BASS] button so that its indicator goes out. Press the button again to turn that part back on.

NOTES

- The indicators for all tracks that contain data in any section will light whenever an accompaniment style is selected. (Depending on the selected accompaniment style, some tracks may not contain any data.)

● What's In the Tracks

Here's how the tracks are normally used:

- RHYTHM 1:** This is the main rhythm track, and usually plays a drum kit.
- RHYTHM 2:** Additional rhythm. Turning the RHYTHM 2 track ON will usually increase the “energy” of the rhythm. In many styles this track plays percussion instruments such as congas, bongos, etc. This means you can turn off the RHYTHM 1 track and use only RHYTHM 2 for a “light” rhythm sound.

Auto Accompaniment

BASS: The BASS track always plays a bass line, but the voice will change to fit the selected style ... acoustic bass, synth bass, tuba, etc.

RHYTHMIC CHORD 1 & 2: Both these tracks provide the rhythmic chordal accompaniment required by each style. You'll find guitar, piano, and other chordal instruments here.

PAD CHORD: This track plays long chords where necessary, using sustained instruments such as strings, organ, choir.

PHRASE 1 & 2: This is where the musical embellishments reside. The PHRASE tracks are used for punchy brass stabs, arpeggiated chords, and other extras that make the accompaniment more interesting.

Try different combinations of tracks with each style. Some styles will sound best with the full arrangement (all tracks ON), while others might suit your needs better if a smaller arrangement is used. To "thin out" an arrangement, the PHRASE 1 and PHRASE 2 tracks are the first ones you'll want to turn OFF.

Another way to use the tracks is to gradually build up the arrangement during the course of a song. Start with a small arrangement — e.g. RHYTHM 1, BASS, and RHYTHMIC CHORD 1 — then add tracks one by one as you want to thicken the musical texture.

Some styles will actually sound quite different depending on the combination of tracks you choose. Try, for example, just RHYTHM 1, BASS, and PAD CHORD.

Re-voicing the Tracks

To make the TRACK buttons even more versatile, the PSR-510 features a REVOICE function that lets you individually change the voices and several related VOICE section parameters assigned to each track. The parameters that can be changed using the REVOICE function are as follows:

- Voice Number (Percussion Kit Number)
- Volume
- Pan
- DSP Depth
- Octave

1 Select a Track to Re-voice

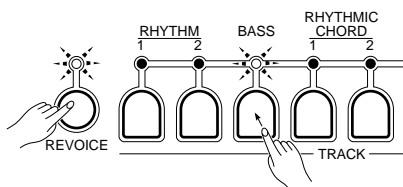

Press the TRACK button corresponding to the track you want to re-voice while holding the [REVOICE] button. Both the selected TRACK and [REVOICE] button indicators will flash. At the same time, the number of the voice currently assigned to the selected track will appear on the MULTI DISPLAY.

NOTES

- At this point you can play the selected track's voice on the keyboard.
- Keyboard percussion is automatically turned on if the RHYTHM 1 or 2 track is selected.

2 Make the Required Voice Settings

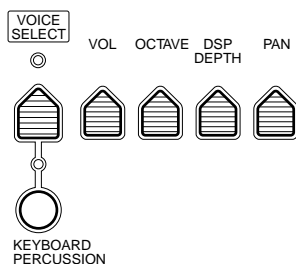

Use the [+] and [-] buttons, the number buttons, the data dial, or the [VOICE SELECT] button itself to select a new voice for the selected track. You can also use the [VOL], [OCTAVE], [DSP DEPTH], and [PAN] buttons to change the corresponding parameters for the selected voice.

NOTES

- You can use the REVOICE function either while the accompaniment is playing or stopped.
- You cannot edit the orchestration parts while the REVOICE indicator is flashing.
- You can play the keyboard and hear the re-voiced voice except for OCTAVE changes.

3 Repeat For All Tracks To Be Re-voiced

Repeat steps 1 and 2 to re-voice all the tracks you want to change.

4 Confirm the Re-voiced Data

Press the [REVOICE] button when you've finished re-voicing the desired tracks to confirm the re-voiced data. The [REVOICE] button and selected track indicators will light.

5 Turn REVOICE OFF to Restore the Original Voices

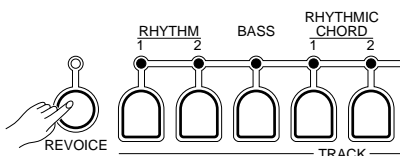

Press the [REVOICE] button so that its indicator goes out to disengage the REVOICE function when done. The re-voiced settings will be cancelled and the original voices for the selected accompaniment style will be re-stored.

NOTES

- **ALL REVOICE settings are reset to their default values if you changes styles while the REVOICE function is OFF. If you want to keep a re-voiced setup so that it can be easily recalled later, store it in the PSR-510 REGISTRATION MEMORY, described on page 35.**
- As long as you don't change styles while the REVOICE function is OFF, the re-voiced settings are maintained and can be recalled at any time simply by turning the REVOICE function ON.
- If you change styles while the REVOICE function is engaged, the re-voiced settings will be maintained.
- In some cases it may not be possible to re-voice a Custom Accompaniment during accompaniment playback. If this problem occurs, try re-voicing the style while the accompaniment is stopped.

One Touch Setting

Each PSR-510 accompaniment style has a suitable preset voice and other settings that can be instantly recalled by pressing the [ONE TOUCH SETTING] button in the VOICE control section. This makes it simple to recall the optimum settings for each style in one quick operation. To use the One Touch Setting function: select a style, press the [ONE TOUCH SETTING] button so that its indicator lights, then play. As long as the [ONE TOUCH SETTING] indicator is lit the ideal voice and other settings (see list below) will be automatically recalled whenever you select a new style.

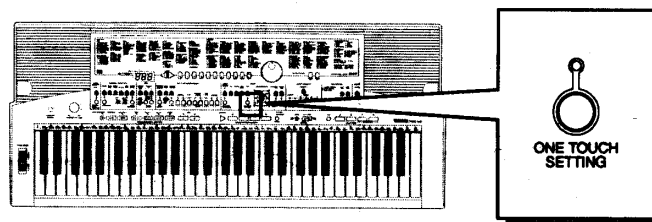

The One Touch Setting function recalls the following settings:



- The preset voice settings for the currently selected style — including orchestration, voice assignments, volume, octave, DSP depth, pan, harmony, and effect settings.
- The ACCOMP VOLUME level (21).
- AUTO ACCOMP is turned ON.
- The default tempo for the currently selected style.
- The track ON/OFF status for the currently selected style.
- [REVOICE] is turned OFF.
- KEYBOARD PERCUSSION is turned OFF.
- The Auto Accompaniment split point (55) is selected.
- The orchestration split point is set to 69.

You can, of course, create your original setting by editing the One Touch Setting data, and store it into the Registration Memory. (See page 35 for more information on the Registration Memory.)

Pressing the [ONE TOUCH SETTING] button again turns OFF the One Touch Setting function.



- If you press [ONE TOUCH SETTING] while rhythm-only accompaniment is playing, AUTO ACCOMP will be turned ON.
- The synchro start mode will be engaged if the [ONE TOUCH SETTING] button is turned on while the accompaniment is stopped.
- The [ONE TOUCH SETTING] button cannot be turned on when style number "00" is selected. This applied to all PAGE MEMORY numbers.

Registration Memory

The PSR-510 REGISTRATION MEMORY can be used to store four complete sets of VOICE and AUTO ACCOMPANIMENT settings that can be recalled anytime at the touch of a button. The REGISTRATION MEMORY stores the following parameters:

VOICE

- | | |
|---|-----------------------------------|
| 1. Voice numbers for all four orchestration parts. | 7. Harmony ON/OFF & Harmony type. |
| 2. Keyboard percussion ON/OFF & percussion kit number. | 8. Effect ON/OFF & Effect type. |
| 3. Volume (all four orchestration parts and percussion). | 9. Orchestration & Edit ON/OFF. |
| 4. Pan (all four orchestration parts and percussion). | 10. Split point. |
| 5. DSP Depth (all four orchestration parts and percussion). | 11. Touch sense & Touch response. |
| 6. Octave (all four orchestration parts and percussion). | 12. Pitch bend range. |
| | 13. Local ON/OFF status (L & R) |
| | 14. MIDI OUT ON/OFF (L & R) |

AUTO ACCOMPANIMENT

1. Style number.
2. Accompaniment volume.
3. Track button settings.
4. Tempo.
5. REVOICE ON/OFF and settings.
6. Split point.
7. Transpose.
8. Accomp. ON/OFF.
9. Fingering mode.

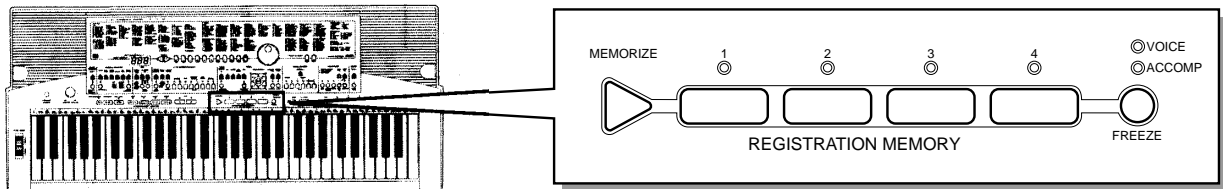

● Memorizing the Settings

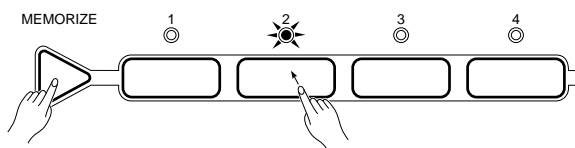

The panel settings listed above can be stored to any one of the four REGISTRATION MEMORY buttons by pressing the button — [1], [2], [3], or [4] — while holding the [MEMORIZE] button. The indicator of the selected button will light continuously indicating that the data has been stored.

NOTES

- Please note that anytime you store to a REGISTRATION MEMORY button, all settings previously stored in that button will be erased and replaced by the new settings.
- The indicator of the selected REGISTRATION MEMORY will flash as soon as any change is made to the panel settings. In other words, if the REGISTRATION MEMORY indicator is flashing, the current panel settings are different from those stored in the memory.

Registration Memory

● Recalling the Settings

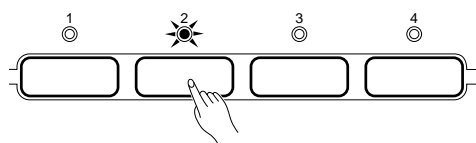

The settings stored to a REGISTRATION MEMORY button can be recalled at any time simply by pressing the appropriate button. The indicator of the selected button will light continuously when initially recalled, but will flash as soon as any change is made to the panel settings. A flashing REGISTRATION MEMORY indicator therefore indicates that the current panel settings do not correspond to those stored in the REGISTRATION MEMORY.

● The FREEZE Function

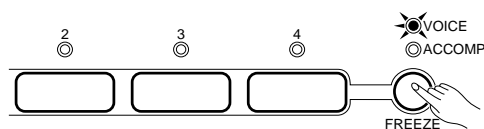

The [FREEZE] button can be used to “freeze” the VOICE or AUTO ACCOMPANIMENT settings so that they are not recalled when a REGISTRATION MEMORY button is pressed. If you press the [FREEZE] button so that only the VOICE indicator is lit, for example, then only the stored AUTO ACCOMPANIMENT settings will be recalled when a REGISTRATION MEMORY button is pressed.

To use the [FREEZE] button, simply press it as many times as necessary to cause the appropriate indicators to light. When an indicator is lit, then the corresponding group of settings is “frozen”.

NOTES

- The FREEZE ON/OFF status is retained in memory even when the power switch is turned off, as long as batteries are installed or an AC adaptor is connected.

Record Functions

The PSR-510 RECORDING section controls three recording functions:

- **The SONG MEMORY:**

Record complete songs including an accompaniment track and up to five melody tracks. Each PAGE MEMORY holds a different song.

- **MULTI PADS:**

Record short chord, melody, or rhythm sequences that can be played back anytime by simply pressing a button. Each PAGE MEMORY holds different MULTI PAD data.

- **CUSTOM ACCOMPANIMENT:**

Create your own accompaniment style for use with the PSR-510 Auto Accompaniment feature. Each PAGE MEMORY holds a different custom accompaniment.

Operation of all three functions is essentially the same, so once you're familiar with the basic procedure, recording songs, multi-pad phrases, or custom accompaniments should be easy. We'll start with the SONG MEMORY.



• *Turning the PSR-510 power OFF during recording or record-ready mode can result in a loss of recording data.*

Song Memory

The PSR-510 SONG MEMORY allows you to record and play back complete songs including chord sequences created using the Auto Accompaniment feature and melody lines you play on the keyboard. The SONG MEMORY has one ACCOMP track and five MELODY tracks. You also have a choice of realtime and step recording modes: the realtime mode records what you play as you play it; the step mode lets you record one step at a time.

Each PAGE MEMORY holds a different song, so the PSR-510 can retain up to 4 complete songs in memory, and these can be selected and played back simply by selecting the appropriate PAGE MEMORY.



• *Material recorded using the SONG MEMORY is retained in memory even when the POWER switch is turned OFF if batteries are present or an AC adaptor is connected (see "PAGE MEMORY" on page 54 for more details).*

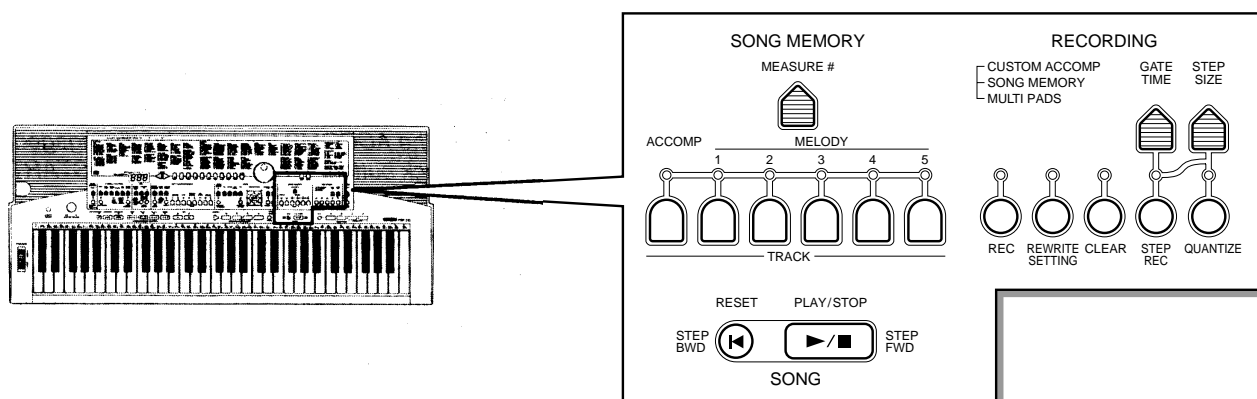

Record Functions

Realtime Accompaniment Track Recording

The SONG MEMORY ACCOMP track records the following operations and data:

- Chord changes.
- Intro, Main, Fill in, & Ending sections.
- Accompaniment volume.
- Fade-in/out.
- Auto accompaniment TRACK button operations.
- Tempo.
- Style number.
- Revoice.

1 Select a PAGE MEMORY

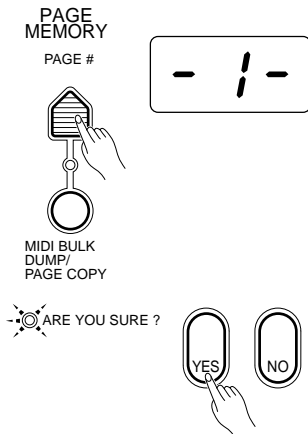

If necessary, press the **[PAGE #]** button to select the PAGE MEMORY number to which you want to record. When a new PAGE MEMORY number is selected the ARE YOU SURE? indicator will flash and the “Are you sure?” prompt will sound. Press the **[YES]** button to select the specified page number or the **[NO]** button to cancel (see page 54 for more details).



- After the “Are you sure?” prompt, the PortaTone will wait until you press **[YES]** or **[NO]**.

2 Select a Style

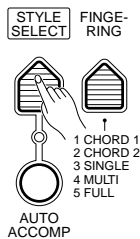

Select an accompaniment style that is appropriate for the type of music you want to record. Also select the fingering mode you want to use, if necessary.

3 Engage the Accompaniment Track Record Ready Mode

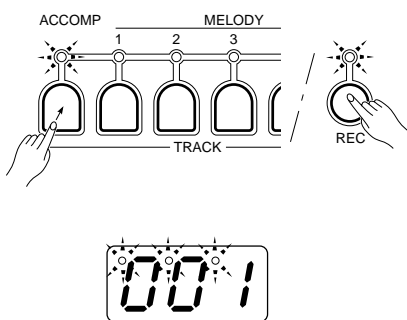

Press the SONG MEMORY section **[ACCOMP]** track button while holding the RECORDING section **[REC]** button. This engages the record ready mode for the accompaniment track. If **[AUTO ACCOMP]** is not already turned on, it will be automatically engaged. The **[REC]**, **[ACCOMP]**, and **[SYNC-START/STOP]** button indicators will flash, and the MULTI DISPLAY BEAT indicator dots will flash at the currently selected tempo. If the OVERALL CONTROL section **[METRONOME]** button indicator is lit, the metronome will sound at the currently selected tempo. The current measure number – in this case “001” – will be shown on the MULTI DISPLAY.



- Accompaniment track recording is carried out using the currently selected Auto Accompaniment fingering mode (page 24).
- The record-ready mode of the ACCOMP track can be disengaged by pressing the **[ACCOMP]** track button. Pressing the **[SYNC-START/STOP]** button does not cancel the record-ready mode.
- It is also possible to record one MELODY track at the same time as you record the ACCOMP track. Hold the **[REC]** button and press the MELODY track button on which you want to record after engaging the ACCOMP track record ready mode. Refer to “Realtime Melody Track Recording” on page 40.
- Turning the power OFF during record-ready mode of the Song Memory erases the song data in the currently selected page.

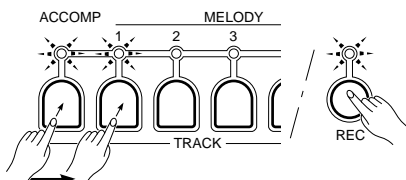

4 Record

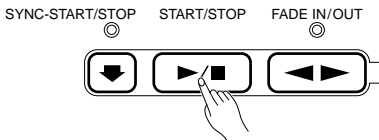
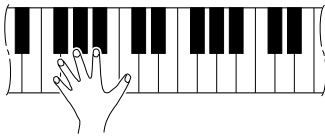

Recording will begin as soon as you play a chord on the Auto Accompaniment section of the keyboard. If you've selected a MELODY track to record with the ACCOMP track, a right-hand note will also start the recording process. The [REC] indicator lights continuously once recording has started, and the current measure number will appear on the MULTI DISPLAY.

Recording can also be started by pressing the ACCOMPANIMENT CONTROL [START/STOP] button. In this case only the rhythm will begin without bass and chord accompaniment until you play the first chord on the Auto Accompaniment section of the keyboard.

Play the required chords in the Auto Accompaniment section of the keyboard. If you've also selected a MELODY track to be recorded, play the melody on the right-hand section of the keyboard.



NOTES

- **Whenever you record using the SONG MEMORY, any previously recorded material in the same track will be erased and replaced by the new material.**
- You can also start recording from any specified measure number — see page 42.
- If the SONG MEMORY becomes full while recording, "End" will appear on the MULTI DISPLAY and recording will stop. Up to approximately 1,600 notes can be recorded in all MELODY tracks in each PAGE MEMORY. Up to approximately 1,600 chords can be recorded in each PAGE MEMORY. These figures only apply, however, if only chords or notes are recorded. The total is reduced when notes and chords are recorded together.
- If you start recording by pressing the [PLAY/STOP] button, nothing will be recorded until you begin playing on the keyboard.
- Previously-recorded SONG MEMORY tracks that are turned ON (their indicators are lit) can be monitored while recording. If you don't want to hear any of the previous tracks while recording, simply press the corresponding SONG MEMORY TRACK buttons so their indicators go out.
- If you use a function button during recording the corresponding value will appear on the MULTI DISPLAY when the button is pressed. The measure number display will resume a few seconds after the button is released.
- The SONG MEMORY ACCOMP track can also be recorded using the Step Record mode (page 48).

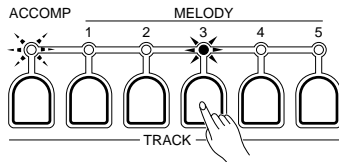

5 Stop Recording

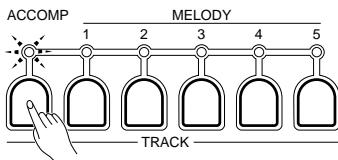

ENDING

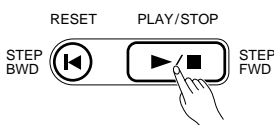
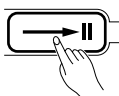

Stop recording by pressing the [ACCOMP] track button. Recording can also be stopped by pressing the [ENDING] button, [FADE IN/OUT] button, or the SONG [PLAY/STOP] button. The [REC] indicator will go out and the voice number will be shown on the MULTI DISPLAY a few seconds after recording is stopped. Song memory will return to the measure at which recording was started.



NOTES

- "..." will appear on the MULTI DISPLAY while the PSR-510 is processing recorded data.

Record Functions

■ Realtime Melody Track Recording

The SONG MEMORY MELODY tracks record the following operations and data:

- Key on/off (i.e. notes played on the keyboard).
- Key velocity.
- Voice number (Percussion Kit Number).
- Volume.
- Pan.
- DSP depth.
- Harmony on/off & harmony type.
- Effect on/off & effect type.
- Sustain (footswitch) on/off.
- Pitch bend.
- Octave.

* MULTI PAD data cannot be recorded to SONG MEMORY.

1 Select a Voice and Set the Voice Parameters

Select the voice you want to record with (the R1 and R2 voices can be used), and set the voice effects and other parameters as required.

2 Select a Track and Engage the Record Ready Mode

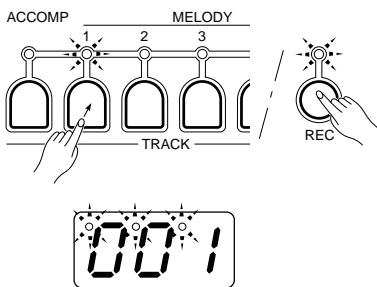

Press one of the MELODY track buttons — [1] through [5] — while holding the RECORDING section [REC] button. Both the [REC] button indicator and the selected MELODY track indicator will flash, indicating that the SONG MEMORY is ready to record. If the OVERALL CONTROL section [METRONOME] button indicator is lit the metronome will also begin to sound at the currently selected tempo, while the MULTI DISPLAY BEAT indicator dots flash at the current tempo. The current measure number – in this case “001” – will be shown on the MULTI DISPLAY.



NOTES

- Previously-recorded SONG MEMORY tracks that are turned ON (their indicators are lit) can be monitored while recording. If you don't want to hear any of the previous tracks while recording, simply press the corresponding SONG MEMORY TRACK buttons so their indicators go out.
- Only one melody track can be recorded at a time.
- If the MELODY track record ready mode is engaged, Auto Accompaniment is automatically turned off.

3 Record

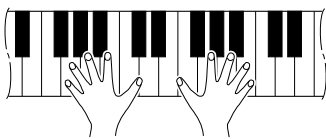

Recording will begin as soon as you play a note on the keyboard or press the SONG [PLAY/STOP] button, and the BEAT indicator dots will begin to indicate the current beat as in the Auto Accompaniment mode, and the current measure number will appear on the MULTI DISPLAY.

Play the melody using the entire keyboard if you are recording only a MELODY track, or on the right-hand section of the keyboard if you are recording a MELODY track at the same time as the ACCOMP track.



NOTES

- The SONG MEMORY MELODY tracks can also be recorded using the Step Record mode — see page 48.

4 Stop Recording

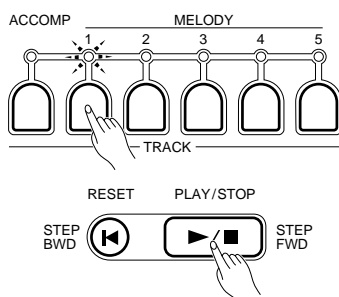

Stop recording by pressing the TRACK button of the melody track being recorded, or the SONG [PLAY/STOP] button. The [REC] indicator will go out and the voice number will be shown on the MULTI DISPLAY a few seconds after recording is stopped. Song memory will return to the measure at which recording was started.



NOTES

- “---” will appear on the MULTI DISPLAY while the PSR-510 is processing recorded data.

■ Accompaniment And Melody Playback

1 Select a PAGE MEMORY

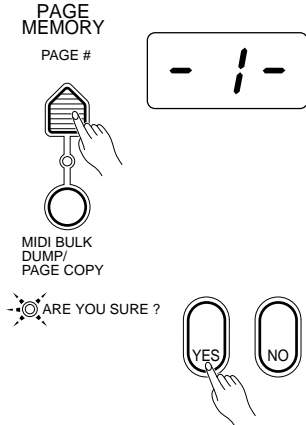

If necessary, press the **[PAGE #]** button to select the PAGE MEMORY number containing the song you want to play back. When a new PAGE MEMORY number is selected the ARE YOU SURE? indicator will flash and the “Are you sure?” prompt will sound. Press the **[YES]** button to select the specified page number or the **[NO]** button to cancel (see page 54 for more details).

NOTES

- After the “Are you sure?” prompt, the PortaTone will wait until you press **[YES]** or **[NO]**.

2 Select the Tracks to Play Back

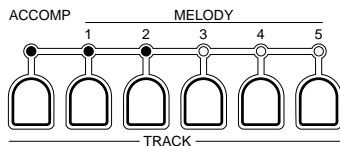

Any number of MELODY tracks and/or the ACCOMP track can be played back at the same time. Press the SONG MEMORY TRACK buttons corresponding to the tracks you want to play back — the indicators of the selected tracks will light.

NOTES

- All SONG MEMORY tracks that contain recorded data are automatically turned ON when a PAGE MEMORY is selected.

3 Start Playback

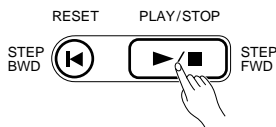

Playback will begin as soon as the SONG **[PLAY/STOP]** button is pressed. You can turn the ACCOMP and MELODY tracks on and off during playback by pressing the appropriate TRACK buttons. During playback the current measure number will appear on the MULTI DISPLAY.

NOTES

- Use the **[RESET]** button to return to the first measure of the song at any time (see page 42).
- You can also start playback from any specified measure by using the **[MEASURE #]** button (see page 42).

4 Play Along If You Like

Play along on the keyboard if you like. You can also change the tempo during playback.

NOTES

- The maximum polyphony is 28. If more than 28 notes are played at the same time, some notes may be truncated.

5 Stop Playback

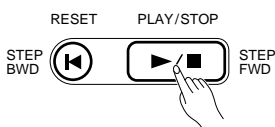

Accompaniment and melody playback will stop automatically when all recorded data has been played back. You can also stop playback at any time by pressing the SONG **[PLAY/STOP]** button.

Record Functions

■ The [RESET] Button

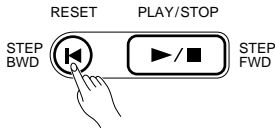

Press the SONG [RESET] button to go directly to the first measure of the song and turn ON all tracks that contain data. Measure number “001” will appear on the MULTI DISPLAY. The [RESET] button also functions during playback or realtime recording.

■ Record Or Play from a Specified Measure

You can start SONG MEMORY recording or playback from any specified measure, as long as the specified measure is within the range of measures that has already been recorded:

1 Press the [MEASURE #] Button If Necessary



If the measure number is not currently shown on the MULTI DISPLAY, press the [MEASURE #] button. If the measure number is already showing, go directly to step 2.

2 Enter the Desired Measure Number

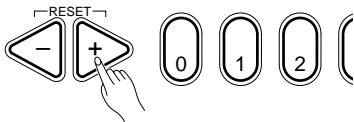

Use the [+] and [-] buttons, the number buttons, the data dial, or the [MEASURE #] button itself to enter the desired measure number.

3 Start Playback or Recording

Start playback or recording. You can now start playback or recording from the specified measure number.



• This function allows you to “punch-in” and “punch-out” at any measure to re-record a section of a previously-recorded track.

Example:

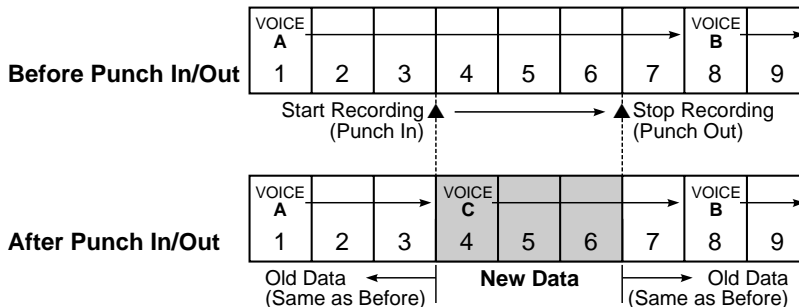

• Voice, volume, pan, pitch bend, tempo, harmony on/off, DSP depth, effect on/off, dual on/off, and revoice data changes made during the punch-in remain in effect even after the punch-in point, until further parameter changes are encountered in the old data.



• Recording is carried out in 1-measure units, so if you punch out in the middle of measure rests will be recorded for the remainder of that measure.

The Multi Pads

The PSR-510 MULTI PADS can be used to record short rhythmic or melodic sequences, percussion fill-ins, or single percussion sounds that can be played at any time simply by pressing the appropriate pad. Pads [1] and [2] play back exactly as recorded, while pads [3] and [4] are “CHORD MATCH” types which are automatically transposed to match chords played using the PSR-510 Auto-accompaniment feature.

Each PAGE MEMORY holds a different set of MULTI PAD data, and these can be selected and played back simply by selecting the appropriate PAGE MEMORY.

The MULTI PADS record the following operations and data:

- Key on/off (i.e. notes played on the keyboard).
- Key velocity.
- Voice number (Percussion Kit Number).
- Volume.
- Pan.
- DSP depth.
- Octave.
- Harmony on/off & harmony type.
- Effect on/off & effect type.
- Sustain on/off.
- Pitch bend.

NOTES

• Before recording, each PAGE MEMORY contains a preset set of MULTI PAD data — 16 phrases in all — that will be erased when new MULTI PAD data is recorded. The original preset data can be restored by using the “Page Reset” function described on page 65.

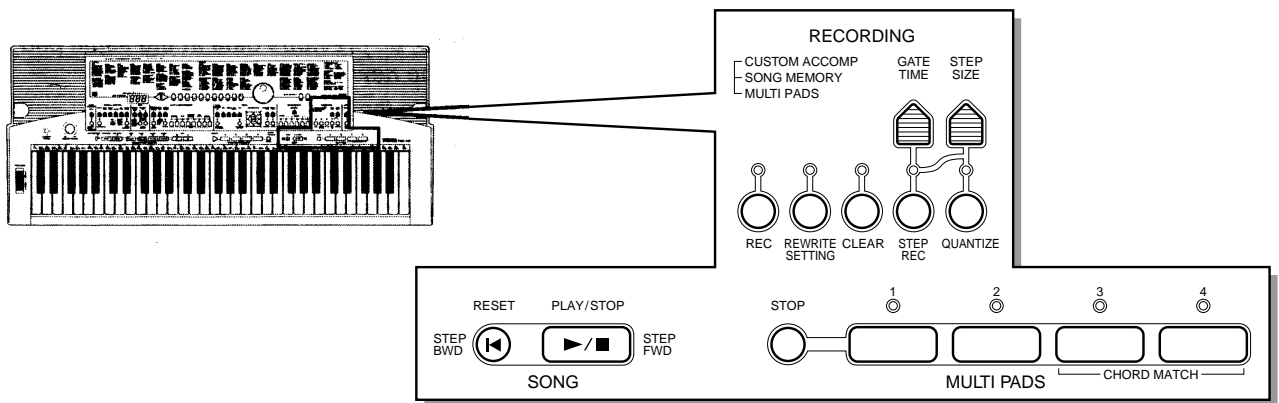

Realtime Recording

1 Select a PAGE MEMORY

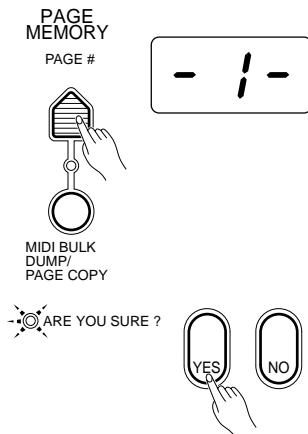

If necessary, press the [PAGE #] button to select the PAGE MEMORY number to which you want to record. When a new PAGE MEMORY number is selected the ARE YOU SURE? indicator will flash and the “Are you sure?” prompt will sound. Press the [YES] button to select the specified page number or the [NO] button to cancel (see page 54 for more details).

NOTES

• After the “Are you sure?” prompt, the PortaTone will wait until you press [YES] or [NO].

2 Select a Voice to Record and an Appropriate Tempo

Select the voice you want to record on the MULTI PADS. Only the [R1] and [R2] voices can be used. You might also want to set a tempo that will be easy to record at.

Record Functions

3 Engage the MULTI PAD Record Ready Mode

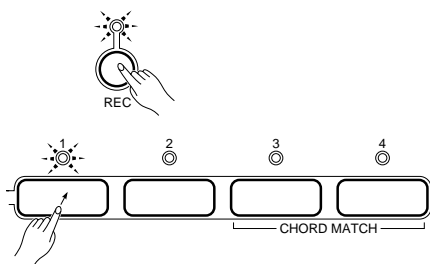

Press one of the MULTI PAD buttons — [1] through [4] — while holding the [REC] button. The [REC] button indicator and the selected MULTI PAD indicator will flash to indicate that the record ready mode is engaged, and the metronome will begin to sound at the currently selected tempo if the OVER-ALL CONTROL section [METRONOME] button indicator is lit.

NOTES

- Only the R1 and R2 orchestration parts can be recorded to the MULTI PADS.
- If the MULTI PAD record ready mode is engaged, Auto Accompaniment is automatically turned off.
- Turning the power OFF during record-ready mode of the Multi Pad erases the Multi Pad data in the currently selected page and restores its default data.

4 Record

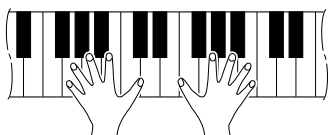

NOTES

Play a short sequence. The MULTI PADS can record up to approximately 450 quarter notes in each PAGE MEMORY. The [REC] button indicator will light during recording, and the BEAT indicator will indicate the current beat as in the Auto Accompaniment mode.

- Whenever you record to a MULTI PAD, all previous data in the same pad will be completely erased and replaced by the new material.
- Recording can also be started by pressing the [PLAY/STOP] button.
- The MULTI PADS can also be recorded using the Step Record mode — see page 48.
- When recording the CHORD MATCH pads — [3] and [4] — base all melodic and chordal phrases on a CM7 chord so that the sound will be properly transposed when used with the Auto Accompaniment feature (see “Playback” below).

5 Stop Recording

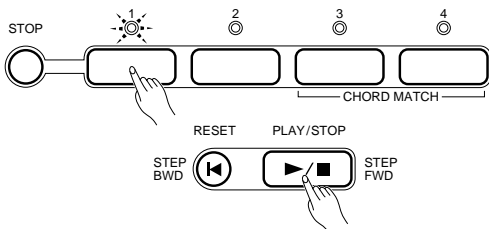

Press the MULTI PAD button being recorded, the MULTI PADS [STOP] button or the [PLAY/STOP] button to stop recording. Recording will also stop automatically and “End” will appear on the MULTI DISPLAY when the pad memory becomes full.

Playback

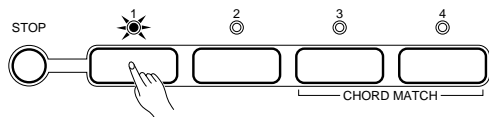

Simply tap any of the MULTI PADS at any time to play back the data they contain. MULTI PAD playback begins as soon as the button is pressed. You can even play two, three, or four MULTI PADS at the same time. Also, you can create “retriggered sample” effects by repeatedly pressing a pad before its contents are completely played back.

The MULTI PAD voices are independent from the voices you have currently selected for keyboard performance. You could, for example, play piano on the keyboard while a MULTI PAD plays a brass chord stab.

MULTI PADS [3] and [4] are “CHORD MATCH” types, and the data they contain will be automatically transposed to match chords played using the PSR-510 Auto Accompaniment feature.

MULTI PAD playback can be terminated by pressing the MULTI PADS [STOP] button.

NOTES

- MULTI PAD playback speed is determined by the current TEMPO setting.
- The contents of the MULTI PAD memory are retained in memory even when the power is turned off as long as batteries are present or an AC adapter is connected to the PSR-510 (see “PAGE MEMORY” on page 54 for details).
- Percussion data recorded to either of the CHORD MATCH pads will play back in the same way as the normal pads.

Custom Accompaniment

Style number “00” in each PAGE MEMORY is a “custom accompaniment” that you can record yourself and use with the PSR-510’s Auto Accompaniment feature. Custom accompaniments can be created only using the tracks which have the preset accompaniment style data.

The CUSTOM ACCOMPANIMENT records the following operations and data:

- Key on/off (i.e. notes played on the keyboard).
- Key velocity.
- Voice number (Percussion Kit Number).
- Volume.
- Pan.
- DSP depth.
- Sustain (footswitch) on/off.
- Pitch Bend

NOTES

• Before recording, each PAGE MEMORY contains a preset accompaniment in style number “00” that will be erased when a custom accompaniment is recorded. The original preset accompaniment can be restored by using the “Page Reset” function described on page 65.

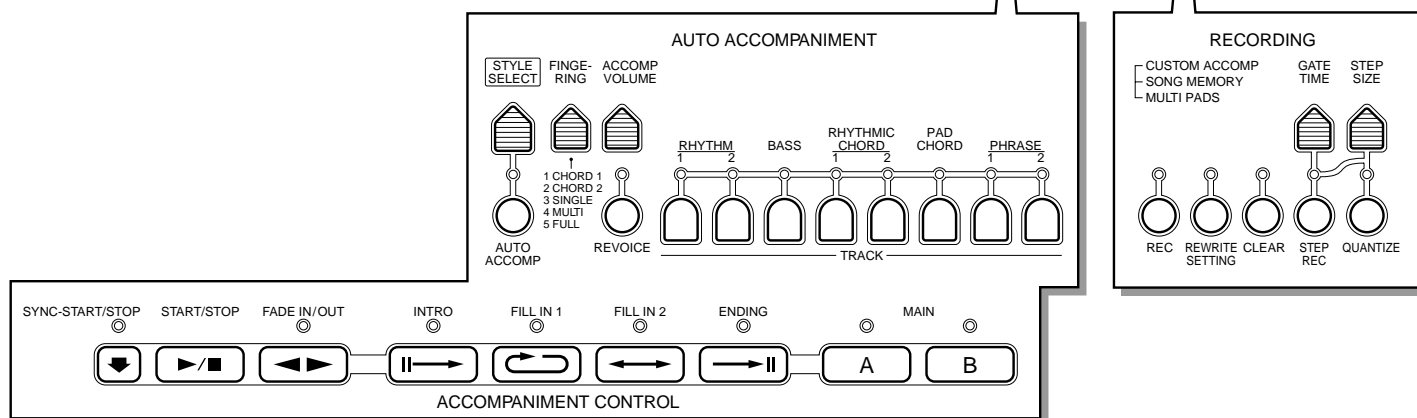
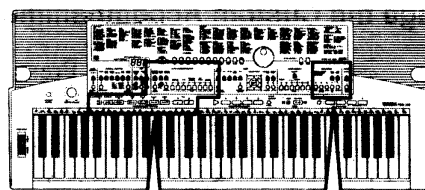

Realtime Custom Accompaniment Recording

1 Select a PAGE MEMORY

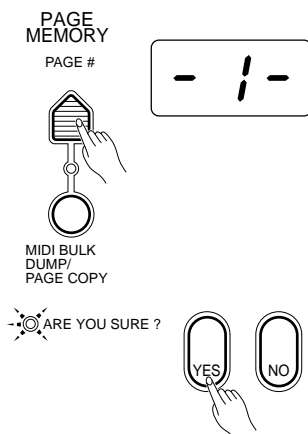

If necessary, press the [PAGE #] button to select the PAGE MEMORY number to which you want to record. When a new PAGE MEMORY number is selected the ARE YOU SURE? indicator will flash and the “Are you sure?” prompt will sound. Press the [YES] button to select the specified page number or the [NO] button to cancel (see page 54 for more details).

NOTES

• After the “Are you sure?” prompt, the PortaTone will wait until you press [YES] or [NO].

Record Functions

2 Select a Style & Section

Select an accompaniment style that will serve as an appropriate foundation for the type of accompaniment you want to record. Also use the ACCOMPANIMENT CONTROL buttons to select the particular section you want to record: INTRO, MAIN A, MAIN B, FILL 1 (for MAIN A or B), FILL 2 (for MAIN A or B), ENDING. When selecting a fill in, be sure to also select the main A or main B section.

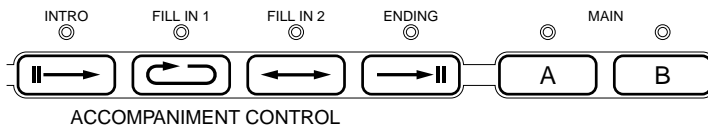

3 Engage the Custom Accompaniment Record Ready Mode

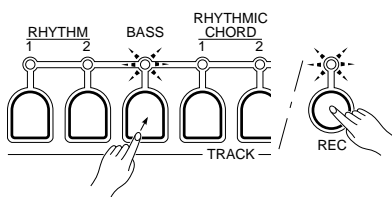

Press the AUTO ACCOMPANIMENT section TRACK button corresponding to the accompaniment track you want to record while holding the RECORDING section [REC] button. (If the selected section's track contains no preset data, "---" will appear on the MULTI DISPLAY and the custom accompaniment record-ready mode can not be engaged.) Both the [REC] and track indicators will flash and, if you've selected a preset accompaniment style on which to base your custom accompaniment (not number "00"), the ARE YOU SURE? indicator will light and the PSR-510 will ask "Are you sure?" (see NOTES, below). Press the [YES] button if you want to go ahead with the record procedure, thus erasing the previous contents of the custom accompaniment. This engages the record ready mode for the specified track. If the OVERALL CONTROL section [METRONOME] button indicator is lit, the metronome will sound at the currently selected tempo. Press [NO] to cancel the operation and preserve the contents.

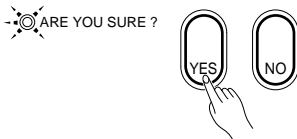

NOTES

- If you select a style number other than "00" on which to base your custom accompaniment, the selected style is copied to the custom accompaniment being recorded as soon as the [YES] button is pressed and the record ready mode is engaged, thus erasing all previous custom accompaniment data in the current page.
- Auto Accompaniment, Auto Harmony, and Effect are turned OFF, the R1 orchestration part is selected, and the [EDIT] button is disabled when the custom accompaniment record ready mode is engaged.
- If a track containing rhythm data is specified for recording, Keyboard Percussion is automatically turned on.
- When the record-ready mode for the selected track is engaged, other track(s) of the corresponding section having no accompaniment style data will automatically be turned off.
- A track that does not contain data in any section (the track indicator is off), cannot be used for custom accompaniment recording.
- Turning the power OFF while the custom accompaniment record-ready mode is engaged erases the custom accompaniment data in the currently selected page.

4 Select a Voice & Set the Tempo as Required

If necessary, select the voice you want to record with, and set a comfortable recording tempo.

NOTES

- The specified voice parameters can be changed later by using the REWRITE SETTING and REVOICE functions (pages 52 and 32).

5 Record

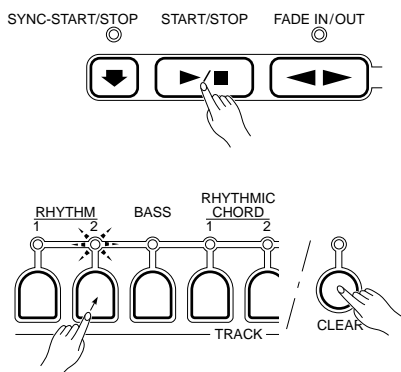

Recording will begin as soon as you press the ACCOMPANIMENT CONTROL section [START/STOP] button or play a chord or note on the keyboard. The preset accompaniment style data in the track being recorded will be entirely erased (except the data you have entered). The accompaniment will play repeatedly, and you can add new material to the selected track by playing on the keyboard.

During recording, you can clear a track if you want to record new material from scratch: press the TRACK button corresponding to the track you want to clear while holding the [CLEAR] button. Individual notes, including Keyboard Percussion instruments, can be cleared by pressing the corresponding key while holding the [CLEAR] button.

NOTES

- Be sure to record your CUSTOM ACCOMPANIMENT based on a CM7 chord. The parts will be automatically transposed to match the chord played when the CUSTOM ACCOMPANIMENT is played back.
- When you clear recorded data while recording, the PSR-510 will not ask you “Are you sure?”.
- Custom accompaniments can also be recorded using the Step Record mode — see page 48.
- With some styles there may be a slight delay between the end of the section and beginning of the next cycle when recording.

6 Repeat to Complete the Accompaniment

Repeat steps 3, 4, and 5, selecting and recording the various tracks as required until your custom accompaniment is complete. You can also switch sections while recording, so you can record an entire custom accompaniment without having to stop recording.

NOTES

- If you change the sections while recording and the current track contains no preset data, “---” will appear on the MULTI DISPLAY to indicate that recording is not possible.

7 Stop Recording



Stop recording by pressing the TRACK button being recorded or the ACCOMPANIMENT CONTROL section [START/STOP] button. The [REC] indicator will go out, and the recorded accompaniment data will automatically be stored in the CUSTOM ACCOMPANIMENT (style number “00”) of the currently selected PAGE MEMORY.

Pressing the [SYNC-START/STOP] button while recording stops recording and returns to step 3 above (record ready mode).

NOTES

- “---” will appear on the MULTI DISPLAY while the PSR-510 is processing recorded data.

Using a Custom Accompaniment

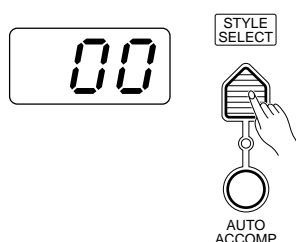

To use a custom accompaniment, simply select the PAGE MEMORY in which it is stored, select style number “00”, and use the Auto Accompaniment feature in the normal way (page 23).

Step Recording

In addition to the realtime-recording procedures described above, the PSR-510 has a “step recording” mode in which notes can be entered one at a time with precise timing and length.



- Only chord sequences can be step-recorded to Song Memory Accomp track. The REWRITE SETTING function (page 52) can be used after step recording to change other parameters as required.
- You can specify the measure from which you want to start song memory step-recording as described on page 42.
- Metronome does not function while recording in step-record mode.
- The following parameters cannot be changed during song memory ACCOMP track step recording: style number, section, track on/off, revoice on/off, registration memory, fade in/out.

1 Engage the Step Record Ready Mode

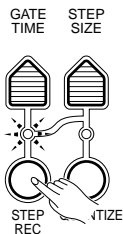

Press the track or pad button corresponding to the track or pad you want to record (see NOTES below) while holding the RECORDING section [STEP REC] button. This engages the record ready mode for the specified track or pad. Both the [STEP REC] and track/pad button indicators will flash.



- When the step record-ready mode for Song Memory Accomp track is engaged, the indicator of MAIN A section will light.
- To step record a SONG MEMORY track press the appropriate SONG MEMORY track button; to step record a CUSTOM ACCOMPANIMENT track press the appropriate AUTO ACCOMPANIMENT track button; to step record a MULTI PAD press the appropriate pad.

2 Specify the Required Step Size

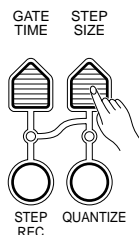

“Step Size” refers to the length of the note to be entered. To enter an eighth note and advance to the next eighth note, for example, the step size should be set to “8”, which corresponds to “1/8” as shown in the list below.

Press the [STEP SIZE] button and the current step size will appear on the MULTI DISPLAY. Then use the [+] and [-] buttons, the data dial, or the [STEP SIZE] button itself to select the required step size (4 ... 32). The “16” step size can be instantly selected by pressing the [+] and [-] buttons simultaneously.

Step Size Settings

MULTI DISPLAY	STEP SIZE	
4	1/4-note	
6	1/6-note	
8	1/8-note	
12	1/12-note	
16	1/16-note	
24	1/24-note	
32	1/32-note	



- The currently selected step size is retained in memory even when the power switch is turned off, as long as batteries are installed or an AC adaptor is connected.

3 Specify the Required Gate Time

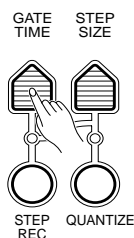

“Gate Time” refers to the actual length of the note to be entered in relation to the note’s step size — i.e. whether the note is staccato, legato, etc. Gate times are specified as percentages of the total note length, as shown in the list below.

Press the [GATE TIME] button and the current gate time will appear on the MULTI DISPLAY. Then use the [+] and [-] buttons, the number buttons, the data dial, or the [GATE TIME] button itself to select the required gate time (00 ... 10). The “08” gate time can be instantly selected by pressing the [+] and [-] buttons simultaneously.

Gate Time Settings

MULTI DISPLAY	GATE TIME		MULTI DISPLAY	GATE TIME	
00	MIN.	(Most staccato)	06	60%	} Normal
01	10%		07	70%	
02	20%		08	80%	
03	30%		09	90%	
04	40%		10	MAX.	
05	50%				



- The current gate time setting is retained in memory even when the power switch is turned off, as long as batteries are installed or an AC adaptor is connected.

4 Play a Note or Chord

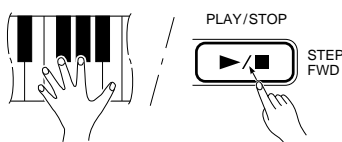

Play the note on the keyboard corresponding to the pitch of the note you want to enter, or a chord if you want to enter a chord. You can then press the [STEP FWD (PLAY/STOP)] button while still holding the note or chord as many times as necessary to extend the length of the note or chord by the specified step size.



- When several notes are played simultaneously, all the notes will be recorded at one time as a chord after the last key pressed is released. This is a handy technique for the chord progression recording.

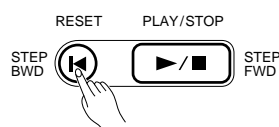
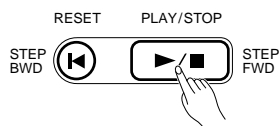

To Enter a Rest ...

Rests can be entered by pressing only the [STEP FWD (PLAY/STOP)] button immediately after specifying the required step size for the rest.

The MULTI DISPLAY During Step Record

During step recording the leftmost digit on the MULTI DISPLAY represents the current beat, and the rightmost two digits represent the current clock within the current beat (each beat consists of 96 clocks). The BEAT indicator dots function in the same way as they do in the Auto Accompaniment mode.

Stepping Backward

In the STEP RECORD mode the [RESET] button functions as the [STEP BWD] (step backward) button. You can use this button to step backward through the recording by the currently specified step size while erasing the data.

Editing Functions

The following functions make it possible to “edit” recorded data to polish and refine your sound.



- When using any of the editing functions on a custom style, be sure to select style number 00 before engaging the editing function.

■ Quantization

It is possible to “quantize” recorded data to straighten out the timing of a track or pad.

1 Set the Quantize Step Size

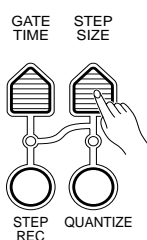

Set the required quantize step size in the same way as the step-record step size (see page 48).

2 Select the Track or Pad to Be Quantized

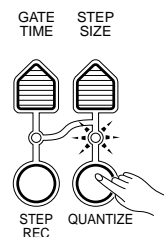

Press the track or pad button corresponding to the track or pad you want to quantize while holding the RECORDING section [QUANTIZE] button. Both the [QUANTIZE] and track/pad button indicators will flash. The ARE YOU SURE? indicator will light and the PSR-510 will ask “Are you sure?”



- You can quantize several Song Memory or Custom Accompaniment tracks at the same time. Press the required track buttons one after another while holding the [QUANTIZE] button.



3 Confirm or Cancel the Quantize Operation

Press the [YES] button if you want to go ahead with the quantize operation, thus irreversibly altering the selected track or pad. Press [NO] to cancel the operation and preserve the contents of the track or pad. “---” will appear on the MULTI DISPLAY while the data is being quantized.



- Your recorded data can be quantized. The preset accompaniment track data can not be quantized.

Record Functions

■ Clearing Tracks

The [CLEAR] button can be used to completely erase the following data:

- All data after the current measure in the specified SONG MEMORY track.
- All data from the specified CUSTOM ACCOMPANIMENT track.
- All data from the specified MULTI PAD.

1 For a SONG MEMORY Track, Set the Start Measure

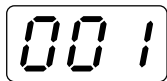

MEASURE #



Use the [MEASURE #] button to set the first measure to be cleared (page 42). All subsequent measures up to the end of the song will be cleared.

2 Specify the Track or Pad to Be Cleared



Press the appropriate track or pad button while holding the [CLEAR] button. The ARE YOU SURE? indicator will light and the PSR-510 will ask “Are you sure?”



- **Turning the power OFF in the clear-ready mode can result in a loss of recorded data.**



- *You can clear several Song Memory or Custom Accompaniment tracks at the same time. Press the required track buttons one after another while holding the [CLEAR] button.*

3 Confirm or Cancel the Clear Operation

ARE YOU SURE?

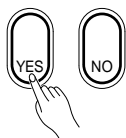

Press the [YES] button if you want to go ahead with the clear operation, thus erasing the selected track or pad. Press [NO] to cancel the operation and preserve the contents of the track or pad. “---” will appear on the MULTI DISPLAY while the data is being cleared.



- *Track indicators in the custom accompaniment clear mode will light when the tracks contain data in any section. A track indicator may remain lit even though the custom accompaniment data for that track has been cleared if the track contain data in other sections.*

■ Changing the Recorded Settings

The [REWRITE SETTING] button can be used to change the settings of all recordable parameters for any specified track or pad. You could, for example, use this function to change the voice or effect used in a SONG MEMORY track.

Rewritable Data

All recorded data in the following tracks and pads except note on/off, octave, sustain, pitch bend, and chord changes:

- Song Memory Accompaniment Track
- Song Memory Melody Tracks
- Custom Accompaniment
- Multi Pad

1 For Song Memory Settings Set the Start Measure



MEASURE #



Only if you will be rewriting Song Memory settings, use the [MEASURE #] button in conjunction with the [+] and [-] buttons, the number buttons, or the data dial to specify the measure at which you want the settings to be rewritten. The specified measure number will appear on the MULTI DISPLAY.

2 Select the Track or Pad to be Altered



Press the track or pad button corresponding to the track or pad you want to alter while holding the RECORDING section [REWRITE SETTING] button (for a Custom Accompaniment, first select the section you want to edit). Both the [REWRITE SETTING] and track/pad button indicators will flash.

3 Change the Settings as Required

■ SONG MEMORY/MULTI PADS

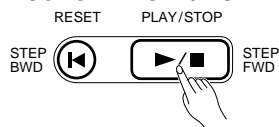

For the Song Memory or Multi Pads use the [PLAY/STOP] button to start playback. Make the required setting changes to the recordable parameters at the appropriate point during playback.

If you make any changes during rewrite standby — i.e. after engaging the Rewrite Setting function but before starting playback — the specified changes will be at the very beginning of the track/pad data (at the beginning of the specified measure for the Song Memory).

■ CUSTOM ACCOMPANIMENT

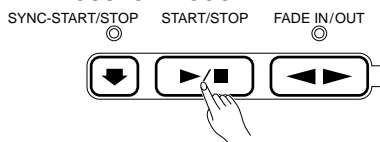

For a Custom Accompaniment, use the ACCOMPANIMENT CONTROL section [START/STOP] button or play a note on the keyboard to start playback and then make the required setting changes to the recordable parameters. Rewriting data in the middle of a Custom Accompaniment pattern affects the entire track.



- Song memory (Accomp track) section and track on/off changes can be rewritten after chord progression recording.
- Your recorded data can be rewritten. The preset accompaniment track data can not be rewritten.

4 Stop

Press the track or pad button for which the settings have been rewritten.



Page Memory

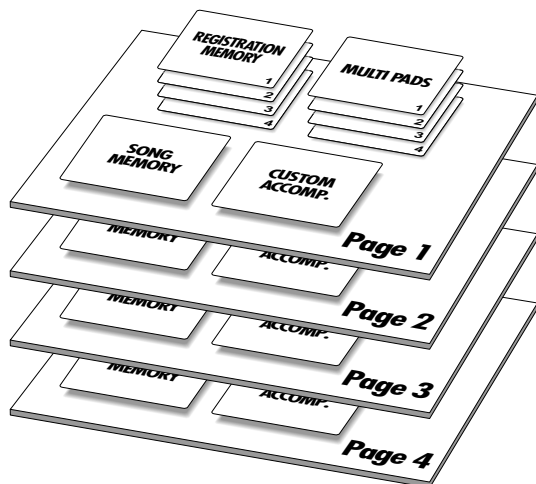

In addition to the REGISTRATION MEMORY described on page 35, the PSR-510 has a PAGE MEMORY that stores panel control and parameter settings plus the contents of the SONG MEMORY, CUSTOM ACCOMPANIMENT, and MULTI PADS. There are four PAGE MEMORY locations, each holding a complete set of parameters and recorded data. The PAGE MEMORY locations are selected as follows:

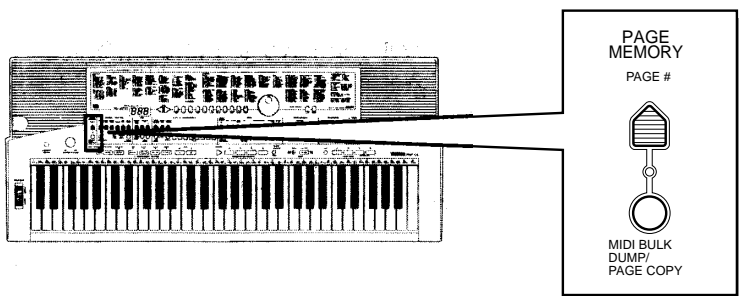

PAGE MEMORY Data

- Registration Memory contents.
- Song Memory contents.
- Custom Accompaniment contents.
- Multi Pad contents.

1 Press the [PAGE #] Button

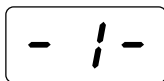

Press the [PAGE #] button once and the current page number will appear on the MULTI DISPLAY.



- Page 1 is automatically selected whenever the power switch is turned on.
- The Page Memory settings are retained in memory even when the power is turned OFF as long as batteries are installed or an AC adaptor is connected to the PSR-510.

2 Select a Page Number

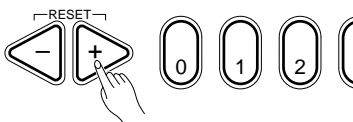

Use the [+/-] and [-] buttons, the number buttons, the data dial, or the [PAGE #] button itself to select the required page number (1 ... 4). When a new PAGE MEMORY number is selected the ARE YOU SURE? indicator will flash and the "Are you sure?" prompt will sound.



- The PAGE MEMORY page number cannot be changed while Auto Accompaniment or DEMO function is engaged.

3 Confirm the Selection

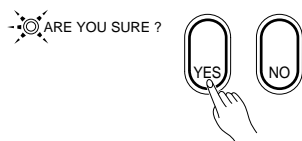

Press the [YES] button to select the specified page number or the [NO] button to cancel.



- The panel settings remain the same unless you press the [YES] button.
- All Registration Memory and recorded data changes are automatically stored in the currently selected PAGE MEMORY, so there's no particular PAGE MEMORY recording procedure.
- Data can be copied from one PAGE MEMORY location to another by using the MIDI BULK DUMP/PAGE COPY function described on page 57.

MIDI, the Musical Instrument Digital Interface, is a world-standard communication interface that allows MIDI-compatible musical instruments and equipment to share musical information and control one another. This makes it possible to create “systems” of MIDI instruments and equipment that offer far greater versatility and control than is available with isolated instruments.

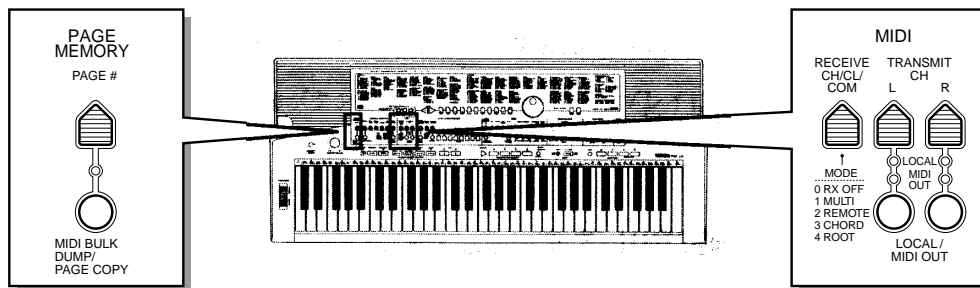

● The PSR-510 MIDI Connectors

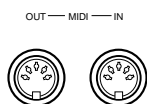

The PSR-510 MIDI IN connector receives MIDI data from an external MIDI device which can be used to control the PSR-510. The MIDI OUT connector transmits MIDI data generated by the PSR-510 (e.g. note and velocity data produced by playing the keyboard).

● Simple MIDI Control

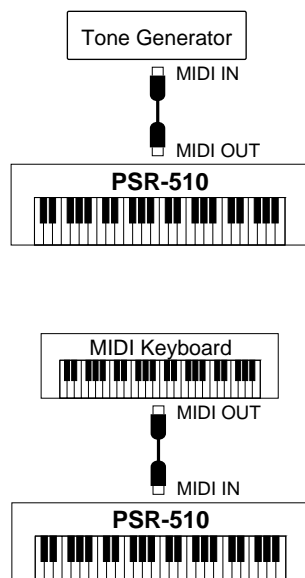

Most MIDI keyboards (including the PSR-510, of course) transmit note and velocity (touch response) information via the MIDI OUT connector whenever a note is played on the keyboard. If the MIDI OUT connector is connected to the MIDI IN connector of a second keyboard (synthesizer, etc.) or a tone generator (essentially a synthesizer with no keyboard), the second keyboard or tone generator will respond precisely to notes played on the original transmitting keyboard. The result is that you can effectively play two instruments at once, providing thick multi-instrument sounds. The PSR-510 also transmits “program change” data when one of its voices is selected. Depending on how the receiving device is set up, the corresponding voice will be automatically selected on the receiving keyboard or tone generator whenever a voice is selected on the PSR-510.

The PSR-510 is capable of receiving the same MIDI data, so a second MIDI keyboard connected to the PSR-510 MIDI IN connector can be used to remotely play the PSR-510 and select voices as required.

● MIDI Sequence Recording

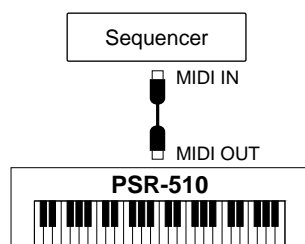

Although the PSR-510 features a built-in “sequencer” (the SONG MEMORY is a type of sequencer), the same type of musical information transfer described above can be used for more sophisticated MIDI sequence recording using an external sequencer or music computer. A MIDI sequence recorder or music computer can be used to “record” MIDI data received from a PSR-510, for example. When the recorded data is played back, the PSR-510 automatically “plays” the recorded performance in precise detail.



• Never use MIDI cables longer than about 15 meters, since cables longer than this can pick up noise which can cause data errors.

MIDI Bulk Dump

MIDI bulk dump operations allow large amounts of MIDI data to be transmitted from one device to another. The entire contents of the currently selected PSR-510 PAGE MEMORY (CUSTOM ACCOMP, MULTI PADS, SONG MEMORY, REGISTRATION MEMORY) can be dumped to a second PSR-510 or to a bulk storage device such as a MIDI data recorder or MIDI computer.

1 Make the Required MIDI Connections

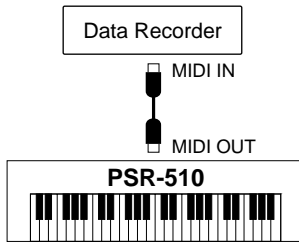

Connect the PSR-510 MIDI OUT terminal to the MIDI IN terminal of the device which is to receive the bulk data.



- You may also have to set up the receiving device to receive the bulk data. Refer to the receiving device's operation manual for MIDI bulk dump reception details.

2 Select a PAGE MEMORY

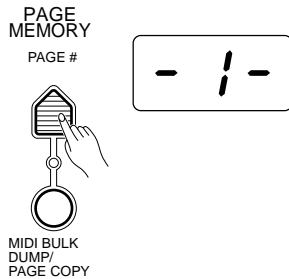

Select the PAGE MEMORY number you want to transmit (page 54).

3 Press the [MIDI BULK DUMP/PAGE COPY] Button

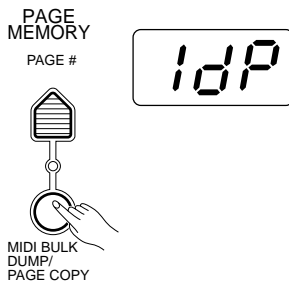

Press the [MIDI BULK DUMP/PAGE COPY] button. The "ARE YOU SURE?" indicator will flash and the PSR-510 will ask "Are you sure?". At the same time "1dP", "2dP", "3dP", or "4dP" will appear on the MULTI DISPLAY, depending on the selected PAGE MEMORY number.

4 Press [YES] to Transmit

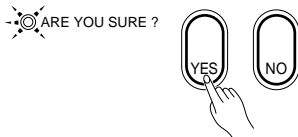

Press the [YES] button to execute the bulk dump operation, or the [NO] button to cancel and return to the VOICE SELECT mode.

The [MIDI BULK DUMP/PAGE COPY] button indicator will light during bulk dump transmission, and will go out when the transmission has finished. The progress of the bulk dump transmission ([-A-]→[-S-]→[-n-]→[-r-]) will also be indicated on the MULTI DISPLAY. When all the data has been transmitted the PSR-510 will automatically return to the VOICE SELECT mode.



- All of the PSR-510 panel controls are disabled during bulk dump transmission.
- Each letter, appears in order on the MULTI DISPLAY, indicates that the following data is sent: [-A-] for Custom Accompaniment data, [-S-] for Song Memory data, [-n-] for Multi Pad data, [-r-] for Registration Memory data.

● Bulk Dump Reception

The PSR-510 will automatically receive bulk dump data from another PSR-510 or MIDI data storage device as long as the MIDI OUT terminal of the external device is properly connected to the MIDI IN connector of the PSR-510, and PSR-510 MIDI reception is enabled.

When this occurs the [MIDI BULK DUMP/PAGE COPY] indicator will light and all panel controls will be disabled during reception. The progress of the bulk dump reception ([-A-]→[-S-]→[-n-]→[-r-]) will be indicated on the MULTI DISPLAY in the same as for bulk dump transmission. When all the data has been received, the [MIDI BULK DUMP/PAGE COPY] indicator will go out and all panel settings will correspond with the received bulk dump data (the received data is saved to the currently selected PAGE MEMORY).



- If an error occurs during bulk dump reception, “Err” will appear on the MULTI DISPLAY and all data in the block in which the error occurred will be initialized (i.e. the corresponding settings will be reset to their power-on values).
- When a bulk dump is received, the contents of the currently selected PAGE MEMORY are erased and replaced by the received data.
- A bulk dump from an external device cannot be received during recording or Auto Accompaniment playback.
- “-A-”, “-S-”, “-n-”, or “-r-” will remain on the MULTI DISPLAY for a short time while after bulk dump reception has finished while the received data is being processed.

■ Page Copy

The [MIDI BULK DUMP/PAGE COPY] button can also be used to copy the entire contents of one PAGE MEMORY number to any other, rather than transmitting the data via the MIDI OUT terminal.

1 Select the PAGE MEMORY Number You Want to Copy

Select the PAGE MEMORY number you want to copy to a different number (page 54).

2 Press the [MIDI BULK DUMP/PAGE COPY] Button

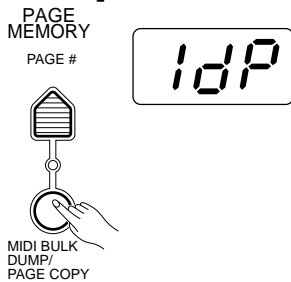

Press the [MIDI BULK DUMP/PAGE COPY] button. The “ARE YOU SURE?” indicator will flash and the PSR-510 will ask “Are you sure?”. At the same time “1dP”, “2dP”, “3dP”, or “4dP” will appear on the MULTI DISPLAY, depending on the selected PAGE MEMORY number.

3 Select the Destination PAGE MEMORY Number

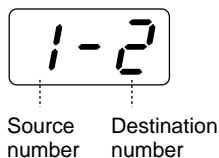

Use the [+] and [-] buttons or the data dial to select the PAGE MEMORY number to which you want to copy the data. The source PAGE MEMORY number appears on the left digit of the MULTI DISPLAY while the destination PAGE MEMORY number appears on the right digit.

The Page Reset Function

When “cL” appears to the right of the page number on the MULTI DISPLAY the page reset function is selected. If you press [YES] to execute the operation as described in the next step, all settings in the selected page will be reset to their initial values.

4 Press [YES] to Copy

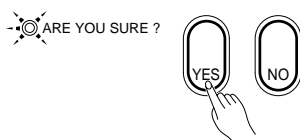

Press the [YES] button to execute the page copy operation, or the [NO] button to cancel and return to the VOICE SELECT mode.

When the data has been copied (this only takes about a second) the PSR-510 will automatically return to the VOICE SELECT mode.

MIDI Reception Modes

The [RECEIVE CH/CL/COM] button is used to specify the reception mode for each of the 16 MIDI channels, the internal or external clock mode, and MIDI start/stop command reception mode.

Channel Reception Modes

The PSR-510 allows any of five reception modes to be individually assigned to MIDI channels 1 through 16. The five modes are:

Mode “0” RX OFF: Reception disabled.

Mode “1” MULTI: Received MIDI note data directly controls the PSR-510 tone generator. Different voices can be played on different channels.

Mode “2” REMOTE: Received MIDI note data is handled in the same way as data from the PSR-510’s own keyboard.

Mode “3” CHORD: Received MIDI note data is interpreted as Auto Accompaniment chord commands.

Mode “4” ROOT: Received MIDI note data is interpreted as Auto Accompaniment bass note commands.



- The send channel must correspond to the channel set for the modes 2-4.
- If the PSR-510 receives more than one note at the same time while mode “4” (ROOT) is selected, the last note will be interpreted as the Auto Accompaniment bass note.

1 Press the [RECEIVE CH/CL/COM] Button & Select a Channel

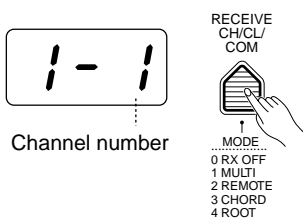

Press the [RECEIVE CH/CL/COM] button, then use the [+] and [-] buttons, the number buttons, the data dial, or the [RECEIVE CH/CL/COM] button itself to select the MIDI channel (1 ... 16) for which you want to specify a new reception mode. The channel number appears on the right of the MULTI DISPLAY.



- “cL” and “cd” will appear on the right of the display if you increment above channel number 16 or below channel number 1. These selections are used for the Clock Mode and Start/Stop Mode functions described below.

2 Select the Desired Mode

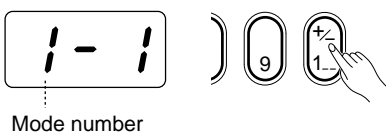

Use the [+/-] button in the number-button row to select the desired reception mode for the selected channel. The modes are selected in sequence each time the [+/-] button is pressed, and the mode number appears on the left digit of the MULTI DISPLAY.



- The currently selected reception mode is retained in memory even when the power switch is turned off, as long as batteries are installed or an AC adaptor is connected.

■ Clock Mode

Reception of an external MIDI clock signal can be enabled or disabled as required. When disabled, all of the PSR-510's time-based functions (Auto Accompaniment, SONG MEMORY, etc.) are controlled by its own internal clock, the speed of which is set by the PSR-510 [TEMPO] button. When MIDI clock reception is enabled, however, all timing is controlled by an external MIDI clock signal received via the PSR-510 MIDI IN terminal (the PSR-510 [TEMPO] setting has no effect).

NOTES

- If clock reception is enabled but no MIDI clock signal is received for more than 400 milliseconds, external clock reception is automatically disabled and normal internal clock operation resumes.
- If you attempt to change the tempo setting when MIDI clock reception is enabled, "EC" will appear on the MULTI DISPLAY.

1 Press the [RECEIVE CH/CL/COM] Button & Select "cL"

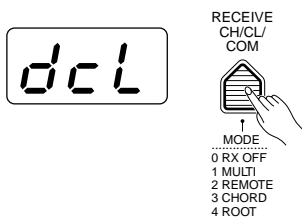

Press the [RECEIVE CH/CL/COM] button, then use the [+] and [-] buttons, the number buttons, the data dial, or the [RECEIVE CH/CL/COM] button itself to select "cL" on the MULTI DISPLAY ("cL" is the next step above MIDI channel 16).

2 Select the Desired Mode



Use the [+/-] button in the number-button row to select the desired clock mode. The disable and enable modes are selected alternately each time the [+/-] button is pressed, and the selected mode appears on the left digit of the MULTI DISPLAY ("d" for disable; "E" for enable).

■ Start/Stop Mode

This function determines the effect of external MIDI start and stop signals. There are three start/stop modes, as follows:

Mode "0" Start/stop reception disabled.

Mode "1" MIDI start and stop commands start and stop the PSR-510 Auto Accompaniment feature.

Mode "2" MIDI start and stop commands start and stop the PSR-510 SONG MEMORY feature.

1 Press the [RECEIVE CH/CL/COM] Button & Select "cd"

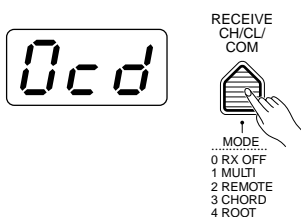

Press the [RECEIVE CH/CL/COM] button, then use the [+] and [-] buttons, the number buttons, the data dial, or the [RECEIVE CH/CL/COM] button itself to select "cd" on the MULTI DISPLAY ("cd" is the next step above "cL" — or the next step below MIDI channel 1).

2 Select the Desired Mode

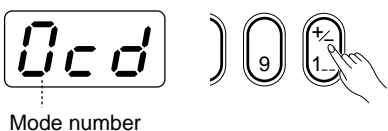

Use the [+/-] button in the number-button row to select the desired start mode. The start/stop modes are selected in sequence each time the [+/-] button is pressed, and the selected mode number appears on the left digit of the MULTI DISPLAY.

MIDI Transmission

The PSR-510 allows independent MIDI transmit channels to be assigned to the L and R ORCHESTRATION voices. It is also possible to independently turn local control and MIDI output on or off for the L and R voices.

MIDI Transmit Channels

The L and R ORCHESTRATION voices can be independently set to transmit on any of the 16 MIDI channels as follows:

1 Press the [L] or [R] TRANSMIT CH

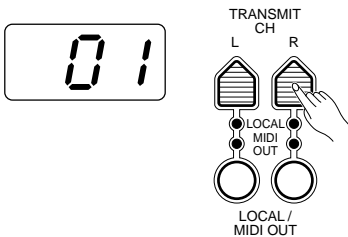

Press the [L] button if you want to set the L voice transmit channel, or the [R] to set the R voice transmit channel. The currently selected channel for the selected voice will appear on the MULTI DISPLAY.



- After selecting L or R, as described above, the default transmit channel can be recalled by simultaneously pressing the [+] and [-] buttons. The default “L” channel number is “2”, and the default “R” channel is “1”.

2 Select the Desired Transmit Channel

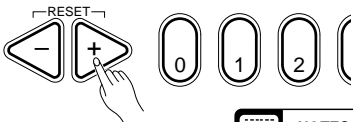

Use the [+] and [-] buttons, the number buttons, the data dial, or the [L] or [R] button itself to select the desired transmit channel.



- The currently selected transmit channel is retained in memory even when the power switch is turned off, as long as batteries are installed or an AC adaptor is connected.
- To record the Song Memory data to an external sequencer, start the sequencer running in the record mode, press the [RESET] button, and then press the [PLAY/STOP] button.
- To record the Auto Accompaniment data to an external sequencer, start the sequencer running in the record mode, select the style you want to record, then start Auto Accompaniment playback.
- Notes played on the keyboard are transmitted on channel 1 or 2 (selectable), Auto Accompaniment data is transmitted on channels 10 - 16, and Song Memory melody data is transmitted on channel 3-7. Normally the Auto Accompaniment Rhythm 1 and Rhythm 2 data are both transmitted on channel 10. To transmit these tracks separately, hold the C1 key while turning the power on. When this is done the Rhythm 1 data will be transmitted on channel 9 while the Rhythm 2 data will be transmitted on channel 10.

Local & MIDI Output ON/OFF

The [LOCAL/MIDI OUT] buttons and indicators below the TRANSMIT CH [L] and [R] buttons can be used to turn local control and MIDI output ON or OFF as required. The status of the LOCAL and MIDI OUT indicators changes as shown below each time the corresponding [LOCAL/MIDI OUT] button is pressed:

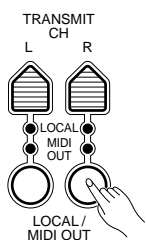

- When “LOCAL” control is turned ON (indicator lit), the PSR-510 is controlled by its own keyboard. When “LOCAL” control is off, playing the PSR-510 keyboard produces no sound — it can only be played by MIDI data received via the MIDI IN terminal.
- When MIDI OUT is turned ON (indicator lit), operating the PSR-510 produces MIDI output. When MIDI OUT is turned OFF (indicator out) no MIDI output is produced by the PSR-510.
- LOCAL & MIDI OUT ON/OFF controls note on/off only. All other data is always output automatically.
- Since LOCAL & MIDI OUT ON/OFF status is memorized in the Registration Memory, you can select the tone generator to be used (PSR-510 or an external tone generator) by changing the registration memory.
- Auto accompaniment will not function when Left LOCAL OFF is selected. Auto accompaniment note on/off data will not be output when Left MIDI OUT OFF is selected.

Appendix

Voice & Polyphony List

The PSR-510 can play up to 28 individual notes at the same time (i.e. it has a maximum “polyphony” of 28). This number includes all voices used: dual, split, auto accompaniment, song memory, and multi pads. If the maximum polyphony of the PSR-510 is exceeded, the excess notes will be truncated (they will not sound).

Another feature affecting polyphony is the fact that some PSR-510 voices actually use two voices at once, as shown in the voice list below. The effective maximum polyphony of the PSR-510 is correspondingly reduced when these voices are used.



• The voice list includes the MIDI program numbers that control each voice when the PSR-510 is played from an external MIDI device.

Voice Number	MIDI Program Number	Voice Name	Number of Voices Used	Voice Number	MIDI Program Number	Voice Name	Number of Voices Used	Voice Number	MIDI Program Number	Voice Name	Number of Voices Used
Piano				45	44	Tremolo Strings	2	Synth Pad			
01	0	Acoustic Grand Piano	1	46	45	Pizzicato Strings	2	89	88	Pad 1 (new age)	2
02	1	Bright Acoustic Piano	1	47	46	Orchestral Harp	1	90	89	Pad 2 (warm)	2
03	2	Electric Grand Piano	2	48	47	Timpani	1	91	90	Pad 3 (polysynth)	2
04	3	Honky-tonk Piano	2	Ensemble				92	91	Pad 4 (choir)	2
05	4	Electric Piano 1	2	49	48	Strings Ensemble 1	1	93	92	Pad 5 (bowed)	2
06	5	Electric Piano 2	2	50	49	Strings Ensemble 2	1	94	93	Pad 6 (metallic)	2
07	6	Harpsichord	1	51	50	Synth Strings 1	2	95	94	Pad 7 (halo)	2
08	7	Clavi	1	52	51	Synth Strings 2	2	96	95	Pad 8 (sweep)	2
Chromatic Percussion				53	52	Choir Aahs	2	Synth Effects			
09	8	Celesta	1	54	53	Voice Oohs	1	97	96	FX 1 (rain)	2
10	9	Glockenspiel	1	55	54	Synth Voice	1	98	97	FX 2 (soundtrack)	2
11	10	Music Box	2	56	55	Orchestra Hit	1	99	98	FX 3 (crystal)	2
12	11	Vibraphone	1	Brass				100	99	FX 4 (atmosphere)	2
13	12	Marimba	1	57	56	Trumpet	1	101	100	FX 5 (brightness)	2
14	13	Xylophone	1	58	57	Trombone	1	102	101	FX 6 (goblins)	2
15	14	Tubular Bells	1	59	58	Tuba	1	103	102	FX 7 (echoes)	2
16	15	Dulcimer	2	60	59	Muted Trumpet	1	104	103	FX 8 (sci-fi)	2
Organ				61	60	French Horn	1	Ethnic			
17	16	Drawbar Organ	2	62	61	Brass Section	1	105	104	Sitar	1
18	17	Percussive Organ	2	63	62	Synth Brass 1	2	106	105	Banjo	1
19	18	Rock Organ	2	64	63	Synth Brass 2	2	107	106	Shamisen	1
20	19	Church Organ	2	Reed				108	107	Koto	1
21	20	Reed Organ	1	65	64	Soprano Sax	1	109	108	Kalimba	1
22	21	Accordion	2	66	65	Alto Sax	1	110	109	Bagpipe	2
23	22	Harmonica	1	67	66	Tenor Sax	1	111	110	Fiddle	1
24	23	Tango Accordion	2	68	67	Baritone Sax	1	112	111	Shanai	1
Guitar				69	68	Oboe	1	Percussive			
25	24	Acoustic Guitar (nylon)	1	70	69	English Horn	1	113	112	Tinkle Bell	2
26	25	Acoustic Guitar (steel)	1	71	70	Bassoon	1	114	113	Agogo	1
27	26	Electric Guitar (jazz)	1	72	71	Clarinet	1	115	114	Steel Drums	2
28	27	Electric Guitar (clean)	2	Pipe				116	115	Woodblock	1
29	28	Electric Guitar (muted)	1	73	72	Piccolo	1	117	116	Taiko Drum	1
30	29	Overdriven Guitar	1	74	73	Flute	1	118	117	Melodic Tom	1
31	30	Distortion Guitar	1	75	74	Recorder	1	119	118	Synth Drum	1
32	31	Guitar Harmonics	1	76	75	Pan Flute	1	120	119	Reverse Cymbal	1
Bass				77	76	Blown Bottle	2	Sound Effects			
33	32	Acoustic Bass	1	78	77	Shakuhachi	1	121	120	Guitar Fret Noise	1
34	33	Electric Bass (finger)	1	79	78	Whistle	1	122	121	Breath Noise	1
35	34	Electric Bass (pick)	1	80	79	Ocarina	1	123	122	Seashore	2
36	35	Fretless Bass	1	Synth Lead				124	123	Bird Tweet	2
37	36	Slap Bass 1	1	81	80	Lead 1 (square)	2	125	124	Telephone Ring	1
38	37	Slap Bass 2	1	82	81	Lead 2 (sawtooth)	2	126	125	Helicopter	2
39	38	Synth Bass 1	1	83	82	Lead 3 (calliope)	2	127	126	Applause	2
40	39	Synth Bass 2	1	84	83	Lead 4 (chiff)	2	128	127	Gunshot	1
Strings				85	84	Lead 5 (charang)	2	<i>* The following voices use only one voice in the indicated ranges: 46 (Pizzicato Strings): all notes below C#2 and above F5. 110 (Bagpipe): all notes above A#2.</i>			
41	40	Violin	1	86	85	Lead 6 (voice)	2				
42	41	Viola	1	87	86	Lead 7 (fifth)	2				
43	42	Cello	1	88	87	Lead 8 (bass+Lead)	2				
44	43	Contrabass	1								

Appendix

Style List

#	Name	Panel Name	Rhythm	Comments
Pop				
01	16-Beat Pop	16BEAT POP	16-Beat	Contemporary 16-beat pop.
02	8-Beat Pop	8BEAT POP	8-Beat	Bright piano/guitar-based '70s pop.
03	8-Beat Light	8BEAT LIGHT	8-Beat	Eight-beat easy-listening style with arpeggiated piano part.
04	FolkRock	FOLKROCK	16-Beat	Guitar-based folk-rock.
05	Detroit Pop	DETROIT POP	12-Beat	Motown-style rhythm, with modern touches.
06	Pop Shuffle	POP SHUFFLE	12-Beat	'70s European pop-shuffle.
07	Pop Rock	POP ROCK	12-Beat	Upbeat, fast pop-rock. Try using your own chords in the intro and ending.
08	Showtune	SHOWTUNE	8-Beat	Bouncy, fully orchestrated style from '40s/'50s musicals. Use SYNC-START and press desired starting key for elaborate intro.
Pop Ballad				
09	16-Beat Ballad	16BT BALLAD	16-Beat	Warm, romantic American soul ballad style.
10	Pop Ballad	POP BALLAD	8-Beat	Romantic pop ballad
11	Big Ballad	BIG BALLAD	8-Beat	Slow ballad with full arpeggios and fancy organ fills.
12	Piano Ballad	PNO BALLAD	8-Beat	Piano-based ballad with slow arpeggios. Huge drum fills in Intro and Fill In 2.
13	Epic Ballad	EPIC BALLAD	8-Beat	Pop ballad style from the '60s and '70s, featuring gentle strings accompaniment in MAIN A and full orchestra in MAIN B.
14	6/8 Ballad	6/8 BALLAD	Six-Eight	Slow rock ballad with triplet feel and classical overtones.
Dance				
15	Eurobeat	EUROBEAT	16-Beat	Fast, 16-beat Eurobeat sound, for disco and house music.
16	Dance Pop	DANCE POP	16-Beat	80s English disco sound.
17	Casa	CASA	16-Beat	Italian house music.
18	Dance Shuffle	DANCE SHFL	24-Beat	Rap/dance feel, especially for one-chord songs. Try playing with CHORD 1 & 2 off.
19	Groundbeat	GROUNDBEAT	24-Beat	Contemporary soul ballad with funky bass. PHRASE 1 adds high string lines and PHRASE 2 adds bass.
20	Synth Boogie	SY BOOGIE	Six-Eight	Fast, machine-like 6/8 computer groove with synth bass.
Disco				
21	Disco Party	DISCO PARTY	16-Beat	Big band disco party style, hugely popular in Europe.
22	Disco Soul	DISCO SOUL	16-Beat	Philadelphia disco style from the '70s.
23	Disco Tropical	DISCO TROP	16-Beat	Disco sound with a Latin feel — echoes of American TV themes from the '80s.
24	Disco Funk	DISCO FUNK	16-Beat	Late '70s New York disco style.
25	Disco Pop	DISCO POP	16-Beat	The world-famous (and recently revived) '70s Swedish disco sound.
26	Polka Pop	POLKA POP	8-Beat	Updated Polka style. Latin percussion in Rhythm 2.
Rhythm & Blues				
27	R&B	R&B	8-Beat	Eight-beat rhythm and blues from the '60s .
28	R&B Ballad	R&B BALLAD	16-Beat	Upbeat West Coast soul ballad.
29	Fast Gospel	FAST GOSPEL	8-Beat	Bright and brassy '60s Chicago Rhythm & Blues style.
30	Gospel	GOSPEL	Six-Eight	Gospel ballad groove for slow tempo songs.
31	6/8 Blues	6/8 BLUES	Six-Eight	New Orleans R&B from the '50s.
32	Blues Shuffle	BLUES	12-Beat	Chicago-type blues shuffle.
33	Soul	SOUL	8-Beat	Simple-but-effective Memphis R&B groove.
34	Funk	FUNK	16-Beat	Oakland's East Bay funk style, with fat horn section and big finale for ending.
35	Funk Shuffle	FUNK SHFL	24-Beat	Funky guitar and funky brass stabs in a funky organ-driven shuffle. Funky!
Rock				
36	Hard Rock	HARD ROCK	8-Beat	Fast, hard-driving rock. P2 brings in cymbal crashes with every chord change.
37	Rock Boogie	RK BOOGIE	12-Beat	Hard-driving boogie with distorted guitar.
38	Rock Pop	ROCK POP	8-Beat	Mid-tempo guitar-based rock.
39	Rock Shuffle	RK SHUFFLE	12-Beat	Smooth pop-rock style. Try bringing in the instrument parts one by one.
40	6/8 Rock	6/8 ROCK	Six-Eight	Slow rock pattern with triplet feel and "House of the Rising Sun"-style arpeggios.
41	Rock Ballad	RK BALLAD	8-Beat	Slow rock ballad. Use RHYTHM 2 to add crash cymbal at chord changes. Take out PHRASE 1 & 2 (guitars) for smoother sound.
42	Rock Classical	RK CLASSIC	16-Beat	Classical instruments like harpsichord and strings over a pop music rhythm section.

#	Name	Panel Name	Rhythm	Comments
Rock & Roll				
43	Rock & Roll	ROCK&ROLL	12-Beat	Old-time '60s Rock&Roll.
44	Boogie Woogie	BOOGIE	12-Beat	Late '50s piano-based rock 'n' roll, with boogie woogie bass. Brass in PHRASE 1 & 2, piano bass in PAD.
45	Twist	TWIST	8-Beat	Straight-eight boogie, with a "Twist."
46	Rockabilly	ROCKABILLY	12-Beat	Simple, updated version of the Memphis "Sun" sound.
47	16-beat Rock & Roll	16RK&ROLL	16-Beat	Hard rock & roll — bringing the "Bo Beat" into the '90s. Bring in more complex guitar, brass comping by playing more complex chords.
Traditional Jazz				
48	Ragtime	RAGTIME	8-Beat	Turn-of-the-century piano style. Piano fills at PHRASE 1, piano bass at PHRASE 2.
49	Dixieland	DIXIELAND	12-Beat	Old-time New Orleans jazz. Trumpet at PHRASE 1, Trombone at PHRASE 2, and Clarinets at PAD.
50	Big Band	BIG BAND	12-Beat	Big Band orchestra style and instrumentation. Piano at CHORD 1, guitar at CHORD 2, trumpets at PHRASE 1, trombones at PHRASE 2, and saxes at PAD.
51	Big Band Ballad	B B BALLAD	12-Beat	Slowly swaying Big Band sound. Use in medley with Jazz Ballad to switch to piano/guitar quartet.
52	Swing	SWING	12-Beat	European big-band swing style. Good for all mid-tempo swing tunes.
53	Swing Waltz	SWING WALTZ	Nine-Eight	Mid-tempo 9/8 waltz.
Contemporary Jazz				
54	BeBop	BEBOP	12-Beat	'40s New York fast Bepop style. Good also for instantly adding a double-time feel to any style!
55	Jazz Ballad	JAZZ BALLAD	12-Beat	Slow jazz style with piano, guitar, bass and brush drums. Turn off PHRASE 1 & 2 when playing piano melody. Use in medley with Big Band Ballad to change orchestration.
56	Jazz Waltz	JAZZ WALTZ	Nine-Eight	Swing style in 3/4 time for playing jazz waltz standards.
57	Fusion	FUSION	16-Beat	Latin flavored 16-beat fusion.
58	Fusion Shuffle	FUSION SHFL	24-Beat	West Coast type funk shuffle.
Latin				
59	Mambo	MAMBO	8-Beat	Contemporary Latin dance music. If playing the melody with a piano sound, turn off CHORD 2.
60	Merengue	MERENGUE	8-Beat	High-energy Latin style with lots of percussion and punchy brass.
61	Beguine	BEGUINE	8-Beat	Slow rumba rhythm, a la "Begin the Beguine."
62	Bomba	BOMBA	16-Beat	Puerto Rican dance rhythm, cousin to the Merengue.
63	Guaguanco	GUAGUANCO	16-Beat	Another high-powered Latin dance style, usually played with drums/percussion only. Use RHYTHM 1 & 2, PHRASE 1 & 2 to bring individual percussion in and out.
Latin Pop				
64	Pop Bossa	POP BOSSA	8-Beat	Soft, electric-piano based Latin pop sound.
65	Bossa Nova Slow	SLOW BOSSA	8-Beat	Mellow and jazzy Bossa Nova style, good for mid to slow tempos.
66	Jazz Samba	JAZZ SAMBA	16-Beat	Traditional Brazilian samba with an added drum set.
67	Modern Cha Cha	MOD CHA CHA	16-Beat	Afro-Cuban dance style for medium slow tempos.
68	Latin Rock	LATIN ROCK	16-Beat	Contemporary Cha Cha with electric bass and drum kit.
Caribbean				
69	Ska	SKA	8-Beat	Ska rhythm. Minor keys add doubled "skank."
70	Calypso	CALYPSO	16-Beat	Traditional Jamaican Calypso music from the '60s.
71	Reggae 16	REGGAE 16	16-Beat	Modern Jamaican Reggae rhythm with fat synth bass.
72	Reggae 12	REGGAE 12	12-Beat	Reggae shuffle.
Country & Western				
73	Bluegrass	BLUEGRASS	16-Beat	Try this one with just CHORD 1 and RHYTHM 1 at first, then build up the arrangement by adding different instruments.
74	Country Pop	C POP	8-Beat	Contemporary country style.
75	Country Rock	C ROCK	8-Beat	Soft country style with pedal steel sound. Guitar voicings are most authentic for simple chords, like major, minor, 7th, etc.
76	Country Ballad	C BALLAD	8-Beat	Especially suited to slow tempos. Also, try playing with CHORD 1 only.
77	Country Waltz	C WALTZ	Nine-Eight	Simple, versatile country style with acoustic guitar. Guitar voicings are most authentic for simple chords, like major, minor, 7th, etc.
78	Country Shuffle	C SHUFFLE	12-Beat	Traditional country style using acoustic guitar. Guitar voicings are most authentic for simple chords, like major, minor, 7th, etc.
79	Western Shuffle	W SHUFFLE	12-Beat	Down-home Country and Western shuffle, with a modern touch.

Appendix

■ Style List

#	Name	Panel Name	Rhythm	Comments
World Music				
80	Polka	POLKA	8-Beat	Traditional Polka style with acoustic instruments. Try altering the arrangement by bringing the accordion and the horn parts in and out.
81	Traditional Waltz	TRAD WALTZ	Three-Four	European waltz with guitar, accordion, clarinet, bass, drums and a string pad. Use CHORD 1 & 2 and PHRASE 1 for guitar/accordion arrangement.
82	Sevillianas	SEVILLIANAS	Three-Four	Fast waltz time — almost flamenco style.
83	Bolero Lento	BOLEROLENTO	8-Beat	Guitar-based style, quite romantic. Bolero Lento is related to Rumba and can be used as a slower variation.
84	Rumba Espagnole	ESPAGNOLE	16-Beat	Spanish guitar style, with relatively full orchestration.
85	Dangdut	DANGDUT	8-Beat	Contemporary Indonesian pop sound.
March				
86	Military March	MARCH	8-Beat	Traditional march style. Trombones at CHORD 1, trumpets at CHORD 2, french horn at PHRASE 1, piccolo at PHRASE 2, xylophone at PAD.
87	6/8 March	6/8 MARCH	Six-Eight	Marching brass band. Change chords during the drum intro to add brass accents.
88	Tarantella	TARANTELLA	Six-Eight	Named after the Tarantula spider, whose bite might cause one to dance in this style, this rhythm is used in the popular song "Funiculi Funicula."
Ballroom Standard				
89	Slow Waltz	SLOW WALTZ	Three-Four	This slow waltz (or English waltz) style has been arranged in the style of a small band.
90	Tango Argentina	TANGO ARGN	8-Beat	Traditional ballroom style Tango.
91	Tango Habanera	TANGO HABA	8-Beat	Latin rhythm best known from the opera "Carmen."
92	Slowfox	SLOWFOX	12-Beat	A standard ballroom dance. This style is suitable for many ballads and slow mellow jazz or swing tunes.
93	Viennese Waltz	VIEN WALTZ	Three-Four	Relaxed, ballroom waltz. Guitar is at CHORD 1, accordion at CHORD 2, pizzicato strings at PHRASE 1, clarinets at PHRASE 2 and mid-register strings at PAD.
94	Foxtrot	FOXTROT	12-Beat	Strict tempo Foxtrot for ballroom dancing.
95	Jive	JIVE	12-Beat	Jive (or Boogie) is a fast ballroom dance.
Ballroom Latin				
96	Rumba	RUMBA	8-Beat	Rumba played in the style of a ballroom orchestra. Related to Beguine and Bolero Lento.
97	Samba	SAMBA	16-Beat	Standard ballroom Samba. Guitar is at CHORD 1 & 2, with 2 playing the lower strings. Turning RHYTHM 2 on/off provides additional variation.
98	Cha Cha	CHA CHA	8-Beat	Strict tempo ChaCha style for ballroom dancing. Try starting only with RHYTHM 2, BASS and CHORD, then bring in other instruments one by one.
99	Pasodoble	PASODOBLE	8-Beat	Flamenco-style rhythm, featuring Spanish guitar. Turning RHYTHM 2 on/off provides additional variation.
Custom Accomp				
00 (Page1)	Rap	RAP	16-Beat	Modern rap/hip-hop rhythm with turntable scratching and other effects. RHYTHM 1 & 2 can stand on their own as basic rhythm tracks.
00 (Page2)	Rave	RAVE	16-Beat	Hard-driving synth bass and "space bleep" synth percussion.
00 (Page3)	Enka	ENKA	8-Beat	Modern arrangement of old Japanese pop style.
00 (Page4)	Zouk	ZOUK	16-Beat	Upbeat Afro-Caribbean dance rhythm with kalimba at PHRASE 1 and xylophone at PHRASE 2.

■ Reset Procedures & Page Memory Default Settings

All PSR-510 page memory settings are retained in memory even when the power switch is turned OFF as long as the PSR-510 is powered by batteries or an AC adapter. You can, however, restore the factory default settings for all four page memories or a single specified page memory by following the procedures outlined below.

● System Reset

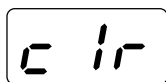
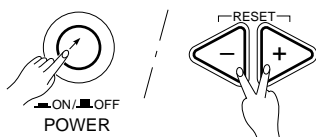

1 Press the POWER switch to turn the PSR-510 power OFF.

2 Turn the power back ON while holding both the [+] and [-] buttons. “clr” will appear on the MULTI DISPLAY while the data is being reset.



• Executing the System Reset function will erase any existing settings all page memory locations!

● Page Reset

1 Select the PAGE MEMORY Number You Want to Reset

Select the PAGE MEMORY number you want to reset (page 54).

2 Press the [MIDI BULK DUMP/PAGE COPY] Button

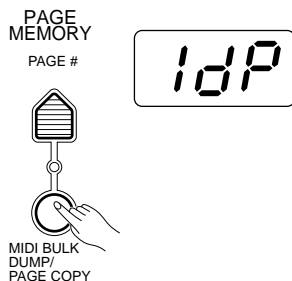

Press the [MIDI BULK DUMP/PAGE COPY] button. The “ARE YOU SURE?” indicator will flash and the PSR-510 will ask “Are you sure?”. At the same time “1dP”, “2dP”, “3dP”, or “4dP” will appear on the MULTI DISPLAY, depending on the selected PAGE MEMORY number.

3 Select a “cL” Display

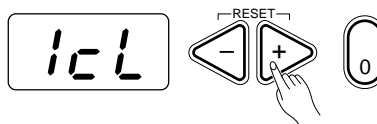

Use the [+] and [-] buttons or the data dial to select “1cL”, “2cL”, “3cL”, or “4cL” (the number corresponds to the selected page number).

4 Press [YES] to Reset

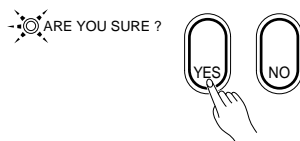

Press the [YES] button to execute the page reset function, or the [NO] button to cancel and return to the PAGE MEMORY number selection mode (step 1, above). All settings in the selected page will be reset to their initial values.

When the data has been reset the PSR-510 will automatically return to the VOICE SELECT mode.



• Executing the Page Reset function will erase any existing settings all selected page memory location!

Appendix

● Page Memory Default Settings

		ORCHESTRATION		VOICE							AUTO ACCOMPANIMENT		OVERALL CONTROL					MULTI PADS	CUSTOM ACCOMP			
		On/Off	VOICE No.	VOL	PAN	OCTAVE	DSP DEPTH	HARMONY		EFFECT		STYLE No.	VOL	TEMPO	SPLIT POINT		P.B. Range	TOUCH		1/2/3/4	style00	
								On/Off	TYPE	On/Off	TYPE				Split mode	Accomp.		On/Off	SENSE			
PAGE1	REGIST1	R1	○	01	21	0	0	6	Off	01	Off	04	08	21	128	61	55	2	On	4	preset x4	Rap
		R2	×	52	21	0	0	6														
		L1	×	33	21	0	-1	6														
		L2	×	06	21	0	0	6														
	PERCUSS.	Off	1	21	0	-1	6															
	REGIST2	R1	○	06	21	0	0	8	Off	01	Off	04	19	21	94	63	55	2	On	4		
		R2	○	53	21	0	-1	8														
		L1	○	37	21	0	-1	6														
		L2	×	35	21	0	-1	6														
	PERCUSS.	Off	1	21	0	-1	6															
	REGIST3	R1	○	19	21	0	0	6	Off	01	Off	01	22	21	120	61	55	2	On	4		
		R2	○	18	21	0	-1	6														
		L1	○	35	21	0	-1	6														
		L2	×	33	21	0	-1	6														
	PERCUSS.	Off	1	21	0	-1	6															
	REGIST4	R1	○	57	21	2	0	12	Off	04	Off	04	87	21	126	61	55	2	On	4		
R2		○	89	21	-2	-1	8															
L1		○	51	21	2	0	8															
L2		○	48	21	-2	-1	8															
PERCUSS.	Off	1	21	0	-1	6																
PAGE2	REGIST1	R1	○	63	21	3	-1	10	Off	01	Off	04	17	21	120	61	55	2	On	4	preset x4	Rave
		R2	○	96	21	-3	-1	12														
		L1	○	88	21	0	-1	6														
		L2	○	64	21	0	0	6														
	PERCUSS.	Off	1	21	0	-1	6															
	REGIST2	R1	○	30	21	0	0	10	Off	01	Off	04	36	21	180	61	55	2	On	4		
		R2	○	85	21	0	0	12														
		L1	×	86	21	0	1	12														
		L2	○	102	21	0	0	12														
	PERCUSS.	Off	1	21	0	-1	6															
	REGIST3	R1	○	83	21	0	0	15	Off	01	Off	04	13	21	78	61	55	2	On	4		
		R2	○	123	21	0	0	12														
		L1	○	26	21	0	0	12														
		L2	○	89	21	0	0	12														
	PERCUSS.	Off	1	21	0	-1	6															
	REGIST4	R1	○	13	21	-3	-1	10	Off	01	On	12	97	21	108	61	55	2	On	4		
R2		○	115	21	3	0	10															
L1		×	12	21	0	1	12															
L2		○	33	21	0	-1	6															
PERCUSS.	Off	1	21	0	-1	6																
PAGE3	REGIST1	R1	○	23	21	0	0	10	Off	01	Off	04	75	21	130	61	55	2	On	4	preset x4	Enka
		R2	×	106	21	0	-1	8														
		L1	○	26	21	0	0	8														
		L2	×	04	21	0	0	6														
	PERCUSS.	Off	1	21	0	-1	6															
	REGIST2	R1	○	62	21	3	-1	10	Off	01	Off	04	50	21	155	61	55	2	On	4		
		R2	○	67	21	-3	-1	10														
		L1	○	33	21	0	-1	8														
		L2	×	01	21	0	0	6														
	PERCUSS.	Off	1	21	0	-1	6															
	REGIST3	R1	○	25	21	2	-1	10	Off	01	Off	04	83	21	102	61	55	2	On	4		
		R2	○	53	10	-2	-1	15														
		L1	○	25	21	-2	-1	8														
		L2	○	52	14	2	-1	15														
	PERCUSS.	Off	1	21	0	-1	6															
	REGIST4	R1	○	06	21	3	0	9	Off	01	Off	04	18	21	112	69	55	2	On	4		
R2		○	05	21	2	0	9															
L1		○	06	21	-3	0	7															
L2		○	51	13	0	0	6															
PERCUSS.	Off	1	21	0	-1	6																
PAGE4	REGIST1	R1	○	20	21	4	0	15	Off	01	Off	01	42	21	114	69	55	2	On	4	preset x4	Zouk
		R2	○	53	21	-4	-1	15														
		L1	×	21	21	0	0	15														
		L2	×	54	21	0	1	15														
	PERCUSS.	Off	1	21	0	-1	6															
	REGIST2	R1	○	04	21	1	0	6	Off	01	Off	01	49	21	180	69	55	2	On	4		
		R2	×	01	21	1	0	6														
		L1	×	02	21	0	0	7														
		L2	×	03	21	0	0	6														
	PERCUSS.	Off	1	21	0	-1	6															
	REGIST3	R1	○	62	21	3	0	10	Off	02	Off	03	81	21	180	61	55	2	On	4		
		R2	○	57	21	-2	0	12														
		L1	○	48	21	-2	-1	10														
		L2	○	59	21	2	-1	12														
	PERCUSS.	Off	1	21	0	-1	6															
	REGIST4	R1	○	54	21	4	0	12	Off	02	Off	03	29	21	128	61	55	2	On	4		
R2		○	92	10	1	-1	10															
L1		○	53	21	-4	0	12															
L2		○	92	10	0	-1	10															
PERCUSS.	Off	1	21	0	-1	6																

* The song memory has no default data, so all data it contains will be erased when a reset operation is executed.

* The MIDI local on/off default settings are R=ON, L=ON.

* The MIDI OUT default settings are R=ON, L=ON.

* The default [EDIT] button indicator setting is R1.

■ Troubleshooting

Something not working as it should? In many cases what appears to be a malfunction can be traced to a simple error that can be remedied immediately. Before assuming that your PSR-510 is faulty, please check the following points.

PROBLEM	POSSIBLE CAUSE/SOLUTION
<ul style="list-style-type: none"> • The PSR-510 speakers produce a “pop” sound whenever the power is turned ON or OFF. 	<ul style="list-style-type: none"> • This is normal and is no cause for alarm.
<ul style="list-style-type: none"> • Reduced volume • Poor sound quality. • Improper demo or song memory playback. • MULTI DISPLAY has gone out and the panel setting has been set to default. 	<ul style="list-style-type: none"> • The batteries probably need to be replaced. Replace all six batteries with new ones of the same type, as described on page 5.
<ul style="list-style-type: none"> • Not all simultaneously-played notes sound. 	<ul style="list-style-type: none"> • You are probably exceeding the maximum polyphony of the PSR-510. The PSR-510 can play up to 28 notes at the same time — including split, dual, auto-accompaniment, and multi pad notes. Notes exceeding this limit will not sound.
<ul style="list-style-type: none"> • Auto accompaniment won't function properly. No lower keyboard sound. 	<ul style="list-style-type: none"> • Auto accompaniment won't sound right if you're using SINGLE type fingering when the SINGLE mode is not selected (page 26). • Are you sure you're playing in the Auto-Accompaniment section of the keyboard? • Are you playing chords that the PSR-510 can recognize (see chord types on pages 25, 26, and 27)?
<ul style="list-style-type: none"> • The selected voice does not sound when the keyboard is played. 	<ul style="list-style-type: none"> • The orchestration part to which the voice is assigned must be turned ON (page 10). • Make sure that the voice volume parameter for the orchestration part to which the voice is assigned is set to an appropriate level (page 13).
<ul style="list-style-type: none"> • Voice parameter changes do not affect the desired voice. 	<ul style="list-style-type: none"> • The edit mode for the voice to which the changes are to be applied must be turned ON (page 12).
<ul style="list-style-type: none"> • No sound when rhythm started. 	<ul style="list-style-type: none"> • Some sections of some styles have no data in the rhythm track. Try turning Auto Accompaniment on and fingering an appropriate chord. The Auto Accompaniment should begin to play.
<ul style="list-style-type: none"> • Sustain ON/OFF status has been reversed. 	<ul style="list-style-type: none"> • Sustain ON/OFF status will be reversed when POWER is turned on with the Footswitch pressed or the footswitch is plugged in while it is being pressed. Turn POWER OFF and turn it back ON to return to normal status.
<ul style="list-style-type: none"> • Song Memory track indicator does not go out when the track is cleared. 	<ul style="list-style-type: none"> • You may have executed the clear function from a point in the middle of the track, thus only clearing the data after that point. Press the [RESET] button to go to the beginning of the track, then clear.
<ul style="list-style-type: none"> • MIDI bulk reception of separate data blocks fails. 	<ul style="list-style-type: none"> • When sending Custom Accompaniment, Song Memory, Multi Pad, and/or Registration Memory data to the PSR-510 as separate blocks from a sequencer or other MIDI device, either send all blocks in succession leaving no more than a 2-second break between blocks, or wait until the voice display appears on the PSR-510 after each block and send the blocks separately.

Index

+ and – buttons 9

A

AC power adaptor 5
Accompaniment control 28
Accompaniment track recording 38
Are you sure? 9, 46, 51, 52, 54
Auto accompaniment 23
Auto harmony 15

B

Batteries 5
Beat indicator 28
Bulk dump, MIDI 56

C

Cleaning 4
Clearing tracks 52
Connectors, MIDI 55
Custom accompaniment 45

D

Data dial 9
Demo song 7
DSP depth 14
DSP type 21
Dual mode 11

E

Edit part selection 12
Editing procedures 8
Effect types 16
Effects 16
Electrical interference 4
Ending 30

F

Fade-in & fade-out 30
Fill-ins 29
Fingering modes 24-27
Freeze function 36
Function button 8

G

Gate time 49

H

Harmony types 15
Headphones 6

I

Introduction (Intro) 29

K

Keyboard percussion 17

L

Local & MIDI output 60

M

Main A & B sections 29
Measure number 42
Melody track recording 40
Metronome 27
MIDI 55-60
MIDI implementation chart 276
Multi pads 43
Music stand 6

N

Note & chord entry, step 49
Number buttons 9

O

Octave 13
One touch setting 34
Orchestration 10
Overall control 19

P

Page number 54
Page copy 57
Page memory 54
Page memory default settings 66
Pan 14
Panel controls (control names) 2-3
Percussion kits 17
Percussion kit list 274
Pitch bend range 18
Pitch bend wheel 18
Playback, accompaniment & melody 41
Playback, custom accompaniment 47
Playback, multi pad 44
Power supply 4, 5

Q

Quantization 51

R

Re-voice 32
Reception modes, MIDI 58
Record functions 37-52
Registration memory 35
Reset button 42
Reset procedures 65
Rest entry, step 49
Rewrite settings 52

S

Service & modification 4
Single modes 10
Song memory 37
Sound system, external 6
Split & dual modes 11
Split modes 11
Split point, orchestration 19
Split point, auto accompaniment 24
Start/stop mode, MIDI 59
Step recording 48
Step size 48
Stopping accompaniment 30
Straight start 28
Style list 62-64
Style selection 23
Sustain 6, 18
Synchro start 28

T

Tempo control 27
Touch sensitivity 22
Tracks (Auto Accompaniment) 31
Transmission, MIDI 60
Transpose 20
Troubleshooting 67
Tuning 20

V

Voice & polyphony list 61
Voice assignment (Voice select) 12
Volume, accompaniment 31
Volume, master 7
Volume, voice 13

Percussion Kit List / Verzeichnis der Schlagzeug- und Percussion-Sets

- * "←" indicates the content is the same as that of Standard Kit.
- * Only 1 note can be played at a time when Keyboard Percussion is engaged.
- * The number in parentheses () after the percussion kit name is the MIDI program number.
- * The corresponding MIDI note numbers for the notes listed in the chart below are actually one octave lower. For example, the MIDI note number for note #36 (C1) in the chart is note #24 (C0).

- * "←" zeigt an, daß der Inhalt identisch mit dem Standardset ist.
- * Bei aktivierter Keyboard Percussion-Funktion kann zu einem Zeitpunkt jeweils nur eine Note gespielt werden.
- * Bei der neben dem Namen des Percussion-Sets in Klammern () gesetzten Nummer handelt es sich um die Programmnummer.
- * Die entsprechenden MIDI-Notennummern für die in der unteren Tabelle aufgeführten Noten liegen tatsächlich eine Oktave tiefer. So ist beispielsweise die MIDI-Notennummer von Note #36 (C1) in der Tabelle die Note #24 (C0).

Note#	Note	1: Standard (0)	2: Room (8)	3: Rock (16)	4: Electronic (24)
36	C1	Click (Square wave)	←	←	←
37	C#1	Brush Tap	←	←	←
38	D1	Brush Swirl	←	←	←
39	D#1	Brush Slap	←	←	←
40	E1	Brush Swirl W/Attack	←	←	Reverse Cymbal
41	F1	Snare Roll	←	←	←
42	F#1	Castanet	←	←	Hi-Q
43	G1	Snare H Soft	Snare Room L	Snare Rock L	Snare Gate L
44	G#1	Sticks	←	←	←
45	A1	Bass Drum H Soft	Bass Drum Room L	Bass Drum Rock L	Bass Drum Gate L
46	A#1	Open Rim Shot	←	←	←
47	B1	Bass Drum L	Bass Drum Room M	Bass Drum Rock M	Bass Drum Gate M
48	C2	Bass Drum H Hard	Bass Drum Room H	Bass Drum Rock H	Bass Drum Gate H
49	C#2	Closed Rim Shot	←	←	←
50	D2	Snare L	Snare Room M	Snare Rock M	Snare Gate M
51	D#2	Hand Clap	←	←	←
52	E2	Snare H Hard	Snare Room H	Snare Rock H	Snare Gate H
53	F2	Floor Tom L	Room Tom 1	Rock Tom 1	Electronic Tom 1
54	F#2	Hi-Hat Closed	←	←	←
55	G2	Floor Tom H	Room Tom 2	Rock Tom 2	Electronic Tom 2
56	G#2	Hi-Hat Pedal	←	←	←
57	A2	Low Tom	Room Tom 3	Rock Tom 3	Electronic Tom 3
58	A#2	Hi-Hat Open	←	←	←
59	B2	Mid Tom L	Room Tom 4	Rock Tom 4	Electronic Tom 4
60	C3	Mid Tom H	Room Tom 5	Rock Tom 5	Electronic Tom 5
61	C#3	Crash Cymbal 1	←	←	←
62	D3	High Tom	Room Tom 6	Rock Tom 6	Electronic Tom 6
63	D#3	Ride Cymbal 1	←	←	←
64	E3	Chinese Cymbal	←	←	←
65	F3	Ride Cymbal Cup	←	←	←
66	F#3	Tambourine	←	←	←
67	G3	Splash Cymbal	←	←	←
68	G#3	Cowbell	←	←	←
69	A3	Crash Cymbal 2	←	←	←
70	A#3	Vibraslap	←	←	←
71	B3	Ride Cymbal 2	←	←	←
72	C4	Bongo H	←	←	←
73	C#4	Bongo L	←	←	←
74	D4	Conga H Mute	←	←	←
75	D#4	Conga H Open	←	←	←
76	E4	Conga L	←	←	←
77	F4	Timbale H	←	←	←
78	F#4	Timbale L	←	←	←
79	G4	Agogo H	←	←	←
80	G#4	Agogo L	←	←	←
81	A4	Cabasa	←	←	←
82	A#4	Maracas	←	←	←
83	B4	Samba Whistle H	←	←	←
84	C5	Samba Whistle L	←	←	←
85	C#5	Guiro Short	←	←	←
86	D5	Guiro Long	←	←	←
87	D#5	Claves	←	←	←
88	E5	Wood Block H	←	←	←
89	F5	Wood Block L	←	←	←
90	F#5	Cuica Mute	←	←	Scratch H
91	G5	Cuica Open	←	←	Scratch L
92	G#5	Triangle Mute	←	←	←
93	A5	Triangle Open	←	←	←
94	A#5	Shaker	←	←	←
95	B5	Jingle Bell	←	←	←
96	C6	Bell Tree	←	←	←
97	C#6	Voice 'One'	←	←	←
98	D6	Voice 'Two'	←	←	←
99	D#6	Voice 'Three'	←	←	←
100	E6	Voice 'Four'	←	←	←
101	F6	Voice 'Are You Sure?'	←	←	←

Liste des kits de percussion / Lista de juegos de percusión

- * “<—” indique que le contenu est le même que celui du kit standard.
- * Une seule note peut être jouée à la fois lorsque le mode de percussion au clavier est activé.
- * Le nombre entre parenthèses () indiqué après le nom du kit de percussion est le numéro de programme MIDI.
- * Les numéros de note MIDI correspondant aux notes indiquées dans le tableau suivant sont en réalité une octave plus basse. Par exemple, le numéro de note MIDI de la note #36 (C1) indiquée dans le tableau est la note #24 (C0).

- * “<—” indica que el contenido es el mismo que el del juego estándar.
- * Sólo puede reproducirse 1 nota al mismo tiempo cuando la percusión del teclado está activada.
- * El número entre paréntesis () después del nombre del juego de percusión es el número de programa MIDI.
- * Los números de nota MIDI correspondientes para las notas listadas en la gráfica de abajo son en realidad una octava más bajas. Por ejemplo, el número de nota MIDI para la nota #36 (C1) en la gráfica es #24(C0).

Note#	Note	5: Analog (25)	6: Jazz (32)	7: Brush (40)	8: Classic (48)
36	C1	<—	<—	<—	<—
37	C#1	<—	<—	<—	<—
38	D1	<—	<—	<—	<—
39	D#1	<—	<—	<—	<—
40	E1	Reverse Cymbal	<—	<—	<—
41	F1	<—	<—	<—	<—
42	F#1	Hi-Q	<—	<—	<—
43	G1	Snare Analog L	<—	Brush Slap L	Snare Classic L
44	G#1	<—	<—	<—	<—
45	A1	Bass Drum Analog L	<—	<—	Gran Casa L
46	A#1	<—	<—	<—	<—
47	B1	Bass Drum Analog M	<—	<—	Gran Casa M
48	C2	Bass Drum Analog H	<—	<—	Gran Casa H
49	C#2	Closed Rim Shot Analog	<—	<—	<—
50	D2	Snare Analog M	<—	Brush Slap H	Snare Classic M
51	D#2	<—	<—	<—	<—
52	E2	Snare Analog H	<—	Brush Tap	Snare Classic H
53	F2	Analog Tom 1	Natural Tom 1	Brush Tom 1	Natural Tom 1
54	F#2	Analog Hi-hat Closed 1	Dark Hi-Hat Closed	Dark Hi-Hat Closed	Dark Hi-Hat Closed
55	G2	Analog Tom 2	Natural Tom 2	Brush Tom 2	Natural Tom 2
56	G#2	Analog Hi-hat Closed 2	Dark Hi-Hat Pedal	Dark Hi-Hat Pedal	Dark Hi-Hat Pedal
57	A2	Analog Tom 3	Natural Tom 3	Brush Tom 3	Natural Tom 3
58	A#2	Analog Hi-hat Open	Dark Hit Hat Open	Dark Hit Hat Open	Dark Hit Hat Open
59	B2	Analog Tom 4	Natural Tom 4	Brush Tom 4	Natural Tom 4
60	C3	Analog Tom 5	Natural Tom 5	Brush Tom 5	Natural Tom 5
61	C#3	<—	<—	<—	Hand Cymbal Long L
62	D3	Analog Tom 6	Natural Tom 6	Brush Tom 6	Natural Tom 6
63	D#3	<—	<—	<—	Hand Cymbal Short L
64	E3	<—	<—	<—	<—
65	F3	<—	<—	<—	<—
66	F#3	<—	<—	<—	<—
67	G3	<—	<—	<—	<—
68	G#3	<—	<—	<—	<—
69	A3	<—	<—	<—	Hand Cymbal Long H
70	A#3	<—	<—	<—	<—
71	B3	<—	<—	<—	Hand Cymbal Short H
72	C4	<—	<—	<—	<—
73	C#4	<—	<—	<—	<—
74	D4	<—	<—	<—	<—
75	D#4	<—	<—	<—	<—
76	E4	<—	<—	<—	<—
77	F4	<—	<—	<—	<—
78	F#4	<—	<—	<—	<—
79	G4	<—	<—	<—	<—
80	G#4	<—	<—	<—	<—
81	A4	<—	<—	<—	<—
82	A#4	<—	<—	<—	<—
83	B4	<—	<—	<—	<—
84	C5	<—	<—	<—	<—
85	C#5	<—	<—	<—	<—
86	D5	<—	<—	<—	<—
87	D#5	<—	<—	<—	<—
88	E5	<—	<—	<—	<—
89	F5	<—	<—	<—	<—
90	F#5	Scratch H	<—	<—	<—
91	G5	Scratch L	<—	<—	<—
92	G#5	<—	<—	<—	<—
93	A5	<—	<—	<—	<—
94	A#5	<—	<—	<—	<—
95	B5	<—	<—	<—	<—
96	C6	<—	<—	<—	<—
97	C#6	<—	<—	<—	<—
98	D6	<—	<—	<—	<—
99	D#6	<—	<—	<—	<—
100	E6	<—	<—	<—	<—
101	F6	<—	<—	<—	<—

MIDI Implementation Chart / Implementierungstabelle / Table

[Portable Keyboard]
Model: PSR-510

MIDI Implementation Chart

Date: 1993. 6. 15
Version: 1.00

Function	Transmitted	Recognized	Remarks
Basic Default Channel Changed	1~16 CH 1~16 CH	1~16 CH (*1) 1~16 CH (*1)	
Mode Default Messages Altered	Mode 3 × *****	(*1) × ×	
Note Number : True voice	0~127 *****	0~127 0~127	
Velocity Note on Note off	○ 9nH, v=1~127 × 9nH, v=0	○ 9nH, v=1~127 × 9nH, v=0 or 8nH	
After key's Touch Ch's	× ×	× ○ (*2)	
Pitch Bender	○	○	
Control Change 0, 32 1 6, 38 7 10 11 64 66 84 90 91 96 97 100, 101 120 121	○ (*3) × ○ ○ ○ ○ ○ ○ × ○ ○ × × × ○ (*6) ○ ×	○ (*4) ○ ○ ○ ○ ○ ○ ○ ○ ○ ○ ○ (*5) ○ ○ ○ ○ (*7) ○ ○ (*8)	Bank select MSB, LSB Modulation depth Data entry MSB, LSB Volume Pan Expression Sustain Sostenuto Portamento control Reverb send level RPN data increment RPN data decrement RPN MSB, LSB All sound off Reset all controllers
Program Change : True #	○ 0~127 *****	○ 0~127 0~127 (*9)	
System Exclusive	○ (*10)	○ (*10)	
System : Song Position : Song Select Common : Tune	× × ×	× × ×	
System : Clock Real Time : Commands	○ ○ (*12)	○ (*11) ○ (*12)	
Aux : Local ON/OFF : All Notes Off Messages : Active Sense : Reset	× ○ ○ ×	× ○ ○ ×	

Mode 1: OMNI ON, POLY
Mode 3: OMNI OFF, POLY

Mode 2: OMNI ON, MONO
Mode 4: OMNI OFF, MONO

○: Yes
×: No

*1. The following modes can be set individually for each channel via the panel control:

- Mode 00: Reception OFF.
- Mode 01: Direct tone generator control.
- Mode 02: Same as keyboard note on/off operation.
- Mode 03: Same as auto-accompaniment chord fingering.
- Mode 04: Same as the lowest-note (bass note) played in the auto-accompaniment chord fingerings.

*2. Channel pressure handled as vibrato.

*3. For bank selection transmission only the MSB changes. The LSB is fixed at 00H.

*4. Bank select reception.

The bank select MSB is used for melody voice and rhythm voice switching.

The bank select LSB is ignored.

- MSB 00H: GM melody voice.
- MSB 7FH: GM rhythm voice.

The default for all the channels excepting channel 10 is 00H. Bank select reception with channel 10 is not possible since channel 10 is assigned to the rhythm accompaniment. However, bank select reception with channel 10 will be possible when you do the following operation: turning the POWER back on while holding the C1 key down.

When the bank select MSB is 01H ... 7EH, all subsequent key-ons received will be ignored.

No voice change will occur when only a bank select is received.

When a program change is received the latest bank select value is used.

*5. Portamento control is effective only when Reception is set in the Multi mode.

*6. A pitch bend sensitivity message is transmitted when a panel pitch bend range setting is made.

Pitch bend sensitivity: BnH, 64H, 00H, 65H, 00H

*7. RPN receives the following data:

Pitch bend sensitivity: BnH, 64H, 00H, 65H, 00H

Default: 02H, 00H

Fine tuning: BnH, 64H, 01H, 65H, 00H

Default: 40H, 00H

Coarse tuning: BnH, 64H, 02H, 65H, 00H

Default: 40H, 00H

Null: BnH, 64H, 7FH, 65H, 7FH

*8. Reset all controllers.

Pitch bend, channel pressure, modulation, expression, sustain, and sostenuto are returned to their default values.

All RPN data is set to NULL.

Portamento is reset.

*9. GM melody voices 0 through 127 become panel voices 1 through 128.

Rhythm voices 0, 8, 16, 24, 25, 32, 40, and 48 become panel voices 1 through 8.

*10. Exclusive.

<GM1 System ON> F0H, 7EH, 7FH, 09H, 01H, F7H

All parameters except MIDI Master Tuning are reset to their default values.

<MIDI Master Volume> F0H, 7FH, 7FH, 04H, 01H, ll, mm, F7H

Allows the volume of all channels to be changed simultaneously (universal system exclusive).

mm is used as the MIDI Master Volume value (ll is ignored).

The default value for mm is 7FH.

This message is receive-only.

<MIDI Master Tuning>

F0H, 43H, 1nH, 27H, 30H, 00H, 00H, mm, ll, cc, F7H

Allows the pitch of all channels to be changed simultaneously (panel tuning).

mmll is used as the MIDI Master Tuning value, and the actual tuning is shown by the expression:

$T = M \times 200 / 256 - 100$

Where T is the actual tuning value in cents. M is decimal value represented by 1-byte using bits 0...3 of mm as the MSB and bits 0...3 of ll as the LSB.

The default values of mm and ll are 07H and 0FH, respectively. n and cc are also recognized.

This value is not reset by a GM System ON or Reset All Controllers message.

This message is transmitted and received.

<Bulk Dump>

bl and bh represent the total byte count as bl+bh*128.

CS: Checksum.

Custom accompaniment: F0H, 43H, 76H, 11H, bl, bh, <Data>, cs, F7H

Multi pad: F0H, 43H, 76H, 12H, bl, bh, <Data>, cs, F7H

Song memory: F0H, 43H, 76H, 13H, bl, bh, <Data>, cs, F7H

Registration memory: F0H, 43H, 76H, 14H, bl, bh, <Data>, cs, F7H

<Panel Control>

Dual data change: F0H, 43H, 76H, 17H, 04H, <Data>, F7H

Dual ON/OFF: F0H, 43H, 76H, 17H, 05H, <Data>, F7H

Harmony/Effect: F0H, 43H, 76H, 17H, 0EH, <Data>, F7H

DSP type: F0H, 43H, 76H, 17H, 0EH, 00H, 01H, <Data>, F7H

Chord/Bass: F0H, 43H, 76H, 17H, 0BH, <Data>, F7H

*11. Internal/external clock selectable.

*12. Operation when a start/stop command is received is determined by the RECEIVE CHANNEL, CLOCK, AND COMMAND panel settings.

0. Start/stop command ignored.

1. Auto-accompaniment start/stop.

2. Song memory start/stop.

Continue neither transmitted nor received.

■ GM System Level 1

The existing MIDI protocol allows performance and other data to be transferred between different instruments, even if they are from different manufacturers. This means, for example, that sequence data that was originally created to control a tone generator from manufacturer A can also be used to control a different tone generator from manufacturer B. Since the voice allocation in different devices from different manufacturers is usually different, however, appropriate program change data must be transmitted to select the right voices.

The General MIDI protocol was developed to minimize confusion and the need for re-programming when playing software created by one MIDI device on another. This has been achieved by defining a standard voice allocation in which the same or similar voices are accessed by the same program change numbers or MIDI channels. The current standard recognized by the International MIDI Association is known as "GM System Level 1." The PSR-510 voice allocation complies with the GM System Level 1 standard.

Das Kommunikationsprotokoll des MIDI-Standards garantiert problemlosen Austausch von Spieldaten und allgemeinen Daten zwischen kompatiblen Instrumenten und Geräten, auch wenn sie von unterschiedlichen Herstellern stammen. Dies wiederum bedeutet, daß beispielsweise Sequenzdaten, die ursprünglich zur Steuerung eines Tongenerators von Hersteller A aufgezeichnet wurden, auch zur Steuerung eines Tongenerators von Hersteller B verwendet werden können. Da jedoch die Stimmen-Programmwechselzuordnung geräte- und herstellerspezifisch unterschiedlich ist, müssen Programmwechseldaten bei der Übertragung in Werte umgesetzt werden, die vom Zielgerät verstanden und zur Wahl der richtigen Stimme genutzt werden können.

Das "General MIDI"-Protokoll wurde ins Leben gerufen, um beim Einsatz von Software, die mit einem Gerät eines anderen Herstellers erstellt wurde, eine größere Verwirrung zu vermeiden und erforderliche Umprogrammierarbeiten auf ein Minimum zu beschränken. Als Grundlage dient eine Standard-Stimmenzuordnung, gemäß der über allgemein definierte Programmwechselnummern bzw. MIDI-Kanäle auf identische bzw. ähnliche Stimmen zugegriffen werden kann. Der gegenwärtig vom internationalen MIDI-Verband anerkannte Standard trägt die englische Bezeichnung "GM System Level 1". Die Stimmenzuordnung im PSR-510 entspricht diesem Standard.

Le protocole MIDI existant permet le transfert des données d'exécution et autres entre plusieurs instruments, même s'ils ne sont pas de la même marque. Ceci signifie, par exemple, qu'un générateur de marque A peut être utilisé pour commander un générateur de sons de marque B. Du fait que l'assignation des voix est généralement différente d'une marque à l'autre, il est nécessaire de transmettre des données de changement de programme appropriées pour sélectionner la voix qui convient.

Le protocole "General MIDI" a été mis au point pour éliminer la confusion et la nécessité de reprogrammer en cas de reproduction sur un appareil MIDI d'un logiciel créé sur un autre appareil. Ceci a été réalisé en définissant une assignation de voix standard dans laquelle des voix identiques ou similaires sont accédées par les mêmes numéros de changement de programme ou de canal MIDI. La norme actuelle, reconnue par l'association MIDI internationale, est appelée "GM System Level 1". L'assignation des voix du PSR-510 est conforme à la norme "GM System Level 1".

El protocolo existente de MIDI permite la transferencia de los datos de interpretación y otros entre instrumentos distintos, aunque sean de marcas diferentes. Esto significa que, por ejemplo, los datos de secuencia que se crearon originalmente para controlar un generador de tonos del fabricante A pueden también usarse para controlar otro generador de tonos del fabricante B. Puesto que normalmente la asignación de voces es distinta en cada aparato de distintas marcas diferentes, deben transmitirse los datos de cambio de programa para seleccionar las voces correctas.

El protocolo MIDI General fue desarrollado para minimizar la confusión y la necesidad de reprogramar cuando se reproducen los programas creados por un aparato MIDI en otro aparato. Esto se ha logrado definiendo una asignación estándar de voces en la que las mismas voces o voces similares se acceden por los mismos números de cambio de programa o canales MIDI. La norma actual reconocida por la asociación MIDI internacional se conoce como "GM System Level 1". La asignación de voces del PSR-510 satisface la norma del "GM System Level 1".

Specifications / Technische Daten / Spécifications / Especificaciones

Keyboards:

61 standard-size keys (C1~C6) with touch response.

VOICE:

AWM128 voices: 01~128

Polyphony: 28

KEYBOARD PERCUSSION: 1~8

VOL: 00~24

OCTAVE: -2~2

DSP DEPTH: 00~15

PAN: -7~7

ONE TOUCH SETTING

ORCHESTRATION: R1/R2/L1/L2

HARMONY: TYPE 01~10, ON/OFF

EFFECT: TYPE 01~12, ON/OFF

Setup:

POWER: ON/OFF

MASTER VOLUME: MIN~MAX

PAGE MEMORY:

PAGE #: 1~4

MIDI BULK DUMP/PAGE COPY

OVERALL CONTROL:

TEMPO: 040~240

METRONOME: ON/OFF

SPLIT POINT

TRANSPOSE: -12~12

TUNING: -16~16

DSP TYPE: 1~8

TOUCH: SENSE 1~5, TOUCH RESPONSE ON/OFF

PITCH BEND: -12~12

AUTO ACCOMPANIMENT:

103 styles: 01~99, 00 in pages 1~4. (00: Custom)

AUTO ACCOMP: ON/OFF

FINGERING: 1~5

ACCOMP VOLUME: 00~24

REVOICE

TRACK: RHYTHM 1/2, BASS, RHYTHMIC CHORD 1/2,

PAD CHORD, PHRASE 1/2

ACCOMPANIMENT CONTROL: SYNC-START/STOP,

START/STOP, FADE IN/OUT, INTRO, FILL IN 1, FILL IN 2,

ENDING, MAIN A/B

REGISTRATION MEMORY:

MEMORIZE

1~4

FREEZE

MULTI PADS:

STOP

1~4 (including 2 chord-match types).

DEMO:

SONG #: ALL, 1~6

START/STOP

SONG MEMORY:

MEASURE #

TRACK: ACCOMP, MELODY 1~5

SONG:

RESET (STEP BWD), PLAY/STOP (STEP FWD)

RECORDING:

REC, REWRITE SETTING, CLEAR, STEP REC,
QUANTIZE, GATE TIME, STEP SIZE

ARE YOU SURE ?:

YES, NO

MULTI DISPLAY:

Number Buttons: [+], [-], [0]~[9], [+/-]

Data Dial

MIDI:

RECEIVE CH/CL/COM, TRANSMIT CH L/R (LOCAL/MIDI
OUT)

Auxiliary Jacks:

DC IN, HEADPHONES/AUX OUT, SUSTAIN PEDAL,
MIDI IN/OUT

Main Amplifiers:

4.5W x 2 (when using PA-5 AC power adaptor)

1.5W x 2 (when using batteries)

HEADPHONES/AUX OUT output: 75Ω impedance.

Speakers:

12cm (4-3/4") x 2

Batteries:

Six SUM-1, "D" size, R-20 or equivalent batteries

Rated Voltage:

DC 10-12V

Dimensions (W x D x H):

939mm x 397mm x 113mm (37" x 15-5/8" x 4-1/2")

Weight:

6.0kg (13.2 lbs.) excluding batteries

Supplied Accessories:

- Music Stand
- Owner's Manual

Optional Accessories:

- Headphones HPE-3, HPE-150
- Keyboard Stand L-2C
- AC Power Adaptor PA-3, PA-4, PA-5, PA-5B, PA-40
- Foot switch FC4, FC5

* Specifications subject to change without notice.

YAMAHA
YAMAHA CORPORATION