

YAMAHA

RHYTHM PROGRAMMER

RY8

OWNER'S MANUAL

SPECIAL MESSAGE SECTION (USA)

This product utilizes batteries or an external power supply (adapter). DO NOT connect this product to any power supply or adapter other than one described in the manual, on the name plate, or specifically recommended by Yamaha.

WARNING: Do not place this product in a position where anyone could walk on, trip over, or roll anything over power or connecting cords of any kind. The use of an extension cord is not recommended! IF you must use an extension cord, the minimum wire size for a 25' cord (or less) is 18 AWG. NOTE: The smaller the AWG number, the larger the current handling capacity. For longer extension cords, consult a local electrician.

This Product should be used only with the components supplied or; a cart, rack, or stand that is recommended by Yamaha. If a cart, etc., is used, please observe all safety markings and instructions that accompany the accessory product.

SPECIFICATIONS SUBJECT TO CHANGE: The information contained in this manual is believed to be correct at the time of printing. However, Yamaha reserves the right to change or modify any of the specifications without notice or obligation to update existing units.

This product, either alone or in combination with an amplifier and headphones or speaker/s, may be capable of producing sound levels that could cause permanent hearing loss. DO NOT operate for long periods of time at a high volume level or at a level that is uncomfortable. If you experience any hearing loss or ringing in the ears, you should consult an audiologist. **IMPORTANT:** The louder the sound, the shorter the time period before damage occurs.

Some Yamaha products may have benches and/or accessory mounting fixtures that are either supplied with the product or as optional accessories. Some of these items are designed to be dealer assembled or installed. Please make sure that benches are stable and

any optional fixtures (where applicable) are well secured BEFORE using. Benches supplied by Yamaha are designed for seating only. No other uses are recommended.

NOTICE: Service charges incurred due to lack of knowledge relating to how a function or effect works (when the unit is operating as designed) are not covered by the manufacturer's warranty, and are therefore the owners responsibility. Please study this manual carefully and consult your dealer before requesting service.

ENVIRONMENTAL ISSUES: Yamaha strives to produce products that are both user safe and environmentally friendly. We sincerely believe that our products and the production methods used to produce them, meet these goals. In keeping with both the letter and the spirit of the law, we want you to be aware of the following:

Battery Notice:

This product MAY contain a small non-rechargeable battery which (if applicable) is soldered in place. The average life span of this type of battery is approximately five years. When replacement becomes necessary, contact a qualified service representative to perform the replacement.

This Product may also use "household" type batteries. Some of these may be rechargeable. Make sure that the battery being charged is a rechargeable type and that the charger is intended for the battery being charged.

When installing batteries, do not mix old batteries with new, or with batteries of a different type. Batteries MUST be installed correctly. Mismatches or incorrect installation may result in overheating and battery case rupture.

Warning: Do not attempt to disassemble, or incinerate any battery. Keep all batteries away from children. Dispose of used batteries promptly and as regulated by the laws in your area.

Note: Check with any retailer of household type batteries in your area for battery disposal information.

Disposal Notice: Should this Product become damaged beyond repair, or for some reason its useful life is considered to be at an end, please observe all local, state, and federal regulations that relate to the disposal of products that contain lead, batteries, plastics, etc. If your dealer is unable to assist you, please contact Yamaha directly.

NAME PLATE LOCATION: The name plate is located on the bottom of the product. The model number, serial number, power requirements, etc., are located on this plate. You

should record the model number, serial number, and the date of purchase in the spaces provided below and retain this manual as a permanent record of your purchase.

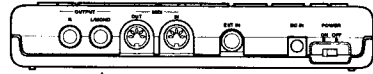

Model _____

Serial No. _____

Purchase Date _____

PLEASE KEEP THIS MANUAL

92-BP

FCC INFORMATION (U.S.A)

1. IMPORTANT NOTICE: DO NOT MODIFY THIS UNIT!

This product, when installed as indicated in the instructions contained in this manual, meets FCC requirements. Modifications not expressly approved by Yamaha may void your authority, granted by the FCC, to use the product.

2. IMPORTANT: When connecting this product to accessories and/or another product use only high quality shielded cables. Cable/s supplied with this product **MUST** be used. Follow all installation instructions. Failure to follow instructions could void your FCC authorization to use this product in the USA.

3. NOTE: This product has been tested and found to comply with the requirements listed in FCC Regulations, Part 15 for Class "B" digital devices. Compliance with these requirements provides a reasonable level of assurance that your use of this product in a residential environment will not result in harmful interference with other electronic devices. This equipment generates/uses radio frequencies and, if not installed and used according to the instructions found in the user's manual, may cause interference harmful to the operation of other electronic devices. Compliance with FCC regulations does not guarantee that interference will not occur in all installations. If this product is found to be the source of interference, which can be determined by turning the unit "OFF" and "ON", please try to eliminate the problem by using one of the following measures:

Relocate either this product or the device that is being affected by the interference.

Utilize power outlets that are on different branch (circuit breaker or fuse) circuits or install AC line filter/s.

In the case of radio or TV interference, relocate/reorient the antenna. If the antenna lead-in is 300 ohm ribbon lead, change the lead-in to co-axial type cable.

If these corrective measures do not produce satisfactory results, please contact the your local retailer authorized to distribute this type of product.

If you can not locate the appropriate retailer, please contact Yamaha Corporation of America, Electronic Service Division, 6600 Orangethorpe Ave, Buena Park, CA 90620

The above statements apply **ONLY** to those products distributed by Yamaha Corporation of America or its subsidiaries.

PRECAUTIONS

IMPORTANT ! PLEASE READ BEFORE PROCEEDING !

The RY8 is a powerful electronic music device featuring sensitive high technology. To ensure many years of trouble-free use, please take the important precautions below seriously.

LOCATION

- In order to avoid causing serious damage to the RY8, do not expose the instrument to direct sunlight, high temperatures, excessive humidity, excessive dust or strong vibration.

POWER SUPPLY

- Turn the power switch off when the RY8 is not in use.
- The AC power adaptor should be unplugged from the AC outlet if the RY8 is not to be used for an extended period of time.
- Unplug the RY8 during electrical storms.
- Avoid plugging the RY8 into the same AC outlet as appliances with high power consumption such as electric heaters or ovens. Also, avoid using multiple-plug adaptors, since these can result in reduced sound quality and possibly even damage to the RY8.

TURN OFF POWER WHEN MAKING CONNECTIONS

- To avoid causing damage to the RY8 and other devices to which it is connected (such as a sound system or MIDI instruments), turn off the power of all related devices prior to connecting or disconnecting audio and MIDI cables.

ELECTRICAL INTERFERENCE

- Avoid using the RY8 near televisions, radios or other devices which generate electromagnetic fields, since this may cause the RY8 to malfunction, and may possibly generate interference noise in the other devices.

HANDLING AND TRANSPORT

■ Handle the RY8 with care. Physical shocks caused by dropping or jostling the instrument, or placing heavy objects upon it, can result in serious damage to the RY8.

■ Never apply excessive force to the controls, pads, or connectors of the instrument.

■ Disconnect all cables before moving the instrument. Always unplug cables by gripping the plug firmly, and not by pulling on the cable itself.

CLEANING

■ Never use chemical solvents or thinners to clean the RY8, since these will damage the finish or the rubber pads. Wipe the instrument clean with a soft, dry cloth. If necessary, use a soft, clean cloth slightly moistened with a diluted, mild detergent. Then wipe the instrument thoroughly with a dry cloth. Avoid placing vinyl objects on the top of the instrument. Vinyl can stick to and discolor the surface.

DATA BACK-UP AND STORAGE

■ Yamaha recommends that you regularly save your music data using an external MIDI data storage device (such as the Yamaha MDF2 MIDI Data Filer), and storing the floppy disks in a safe, cool, dry place. YAMAHA CANNOT BE HELD RESPONSIBLE FOR THE ACCIDENTAL LOSS OF IMPORTANT MUSIC DATA! Regarding the User memory, as long as fresh batteries are inserted in (or an AC power adaptor is connected to) the RY8, the User pattern, song and drum kit data will be retained, even when the power is turned off. It will also be retained long enough to exchange an old set of batteries for a new set. If you have important data in the RY8 which you don't want to lose, please take care to keep fresh batteries inserted in (or keep an AC power adaptor connected to) the RY8, and to regularly save it to an external MIDI data storage device.

SERVICE AND MODIFICATION

■ The RY8 contains no user serviceable parts, so never open the case or tamper with the internal circuitry in any way. Doing so may result in electrical shock or damage to the instrument. Refer all servicing to qualified Yamaha service personnel.

YAMAHA CANNOT BE HELD RESPONSIBLE FOR DAMAGE TO THE RY8 RESULTING FROM IMPROPER HANDLING OR OPERATION !

THANK YOU FOR PURCHASING THE YAMAHA RY8 RHYTHM PROGRAMMER.

The Yamaha RY8 is a full-featured, high quality, low-priced, hand-held stereo rhythm programmer with accompaniment backing and guitar input that's the perfect "pocket pal" for the guitarist on the go.

With its compact size, friendly user interface, wide variety of preprogrammed patterns and songs, user programming capabilities, versatile MIDI features and more, the handy RY8—which easily slips into a guitar case or gig bag—is ready to plug and play anytime and anywhere. It's the ideal music practicing companion and composing sketch pad.

Whether you're a professional or amateur guitarist, a serious songwriter or simply a music hobbyist, you'll find the RY8 a unique and powerful addition to your arsenal of music tools. You'll be surprised by its full, dynamic stereo sound quality when played through a high quality audio monitoring system. You'll also appreciate being able to plug in a guitar and headphones and work in privacy without disturbing others—or better yet, without others disturbing you!

To take full advantage of the RY8's many features and music making capabilities, please read this owner's manual carefully to familiarize yourself with the proper operating procedures. Also, keep this manual in a safe place for future reference.

CONVENTIONS USED IN THIS MANUAL.

In order to keep confusion to a minimum, there are a few basic conventions used in the feature explanations in this manual, as follows:

- Names of key features are written in the cap-low style; e.g., Pattern Mode, Song Record Mode, System Mode Sync function, User patterns, etc.
- Names of controls and connectors are written in all-caps within brackets; e.g., [EXT IN] jack, [VOLUME] slider, [DELETE] button, etc.
- Special prompts or words which appear on the LCD screen during operation are written in quotes; e.g., "NEXT", "CHAIN", "acct", "COPY SURE?", etc.
- Everything else will be written in the lower case style.

PLEASE KEEP THIS MANUAL IN A SAFE PLACE FOR FUTURE

HOW TO USE THIS MANUAL.

The RY8 Owner's Manual is designed to travel alongside the RY8 itself. It includes information about all the RY8's features and operation procedures, organized in such a way as to permit quick and easy access to any feature you need to locate. The main sections of the Owner's Manual are as follows:

BEFORE YOU BEGIN

A brief overview of the RY8's capabilities and system structure, as well as descriptions of all panel features—everything you need to know before you begin using the RY8 in order to put its many features and capabilities into proper context.

GETTING STARTED

A step-by-step guide through setting up the RY8, turning on the power, playing the demo songs and performing basic pattern, song and drum kit operations—everything you need to get started enjoying the RY8 right away.

MODES & FUNCTIONS

An extensive feature reference of the various modes and functions of the RY8—everything you need to know about all operating procedures.

APPENDIX

A collection of technical charts and lists including display messages, troubleshooting, drum voice and pattern lists, MIDI implementation chart and more.

INDEX

An alphabetical list of topics which gives you quick and easy access to any subject in the manual you want to locate.

TABLE OF CONTENTS

BEFORE YOU BEGIN

.....	2
1. THE RY8.....	2
2. RY8 SYSTEM STRUCTURE.....	4
3. TOP PANEL.....	7
4. SIDE & REAR PANELS.....	10

GETTING STARTED

.....	12
5. SETUP & POWER-ON.....	12
6. PLAYING THE DEMO SONG.....	18
7. PLAYING THE DRUM PADS.....	19
8. PLAYING THE PRESET PATTERNS.....	21
9. PLAYING THE PRESET SONGS.....	26

MODES & FUNCTIONS

.....	30
10. PATTERN MODE.....	30
11. SONG MODE.....	41
12. DRUM KIT MODE.....	54
13. EXTERNAL IN MODE.....	61
14. SYSTEM MODE.....	67
15. TEMPO MODE.....	73
16. MUTE MODE.....	74
17. BALANCE MODE.....	75
18. TRANSPOSE MODE.....	76

APPENDIX

.....	77
19. RECALLING THE FACTORY DEFAULT SETTINGS.....	77
20. DISPLAY MESSAGES.....	78
21. TROUBLESHOOTING.....	79
22. SPECIFICATIONS.....	81
23. LISTS & CHARTS.....	82

INDEX

.....	94
-------	----

BEFORE YOU BEGIN

GETTING STARTED

MODES & FUNCTIONS

APPENDIX

INDEX

BEFORE YOU BEGIN

1. THE RY8

The RY8 is an easy-to-use yet powerful rhythm programmer with automatic bass and chord accompaniment backing, an external input for playing along using a guitar, versatile MIDI capabilities and much more.

Featuring Yamaha's exclusive AWM (Advanced Wave Memory) tone generation technology—where voices are high quality digital samples of actual instruments—the RY8 has a large capacity waveform ROM filled with 128 “drum” voices for the rhythms, and 50 “normal” voices for the backings, plus 200 Preset rhythm patterns with matching accompaniment backing encompassing many different popular music styles, and 50 Preset songs and 12 Preset drum kits suitable for any type of music situation. The RY8 also features powerful programming capabilities that let you do the following:

Create Your Own Rhythm Patterns

Record your own one-measure User patterns in step-time or real-time. You can assign any of the preprogrammed backing accompaniments—consisting of Bass, Chord 1 and Chord 2 tracks—to your rhythm.

Create Your Own Songs

String together a series of Preset and User patterns to create your own User song—complete with chord progressions as you specify.

Create Your Own Drum Kits

Assign drum voice sounds to the pads to create your own User drum kits—complete with drum voice pan positioning, pitch tuning and more.



The RY8's many other features include song chaining and loop repeating, rhythm "swing" function for a realistic human feeling, guitar tuner and guitar synthesizer, 28-note polyphony, stereo outputs, headphone jack, and a large LCD screen which always lets you know what mode and status you're currently in. Hence, the RY8 is the ideal music tool that's useful in practically any music situation. You can use it as:

A Practicing Companion

Plug a guitar directly into the RY8 and play along with the patterns and songs. Mute one or more of the accompaniment tracks, or turn the backing off entirely and play along with the rhythm only. The RY8 provides just the music you need for a hot practice session.

A Music Sketch Pad

String together a series of Preset and User rhythm patterns, designate a backing accompaniment, and specify the chord progressions for a song idea. Creating your own songs is quick and easy with the RY8's user-friendly interface.

A Powerful Drum Machine

Program professional sounding rhythm patterns by Step or Realtime recording, complete with accent dynamics and "swing" factor for a realistic human feel. Whether you modify a preset or create your own rhythm pattern from scratch, the RY8's auto-quantizing makes sure your rhythms are always on the beat.

A Guitar Synthesizer

Plug a guitar directly into the RY8 and "trigger" AWM normal voices (including acoustic piano, strings, brass, synth pad sounds and more) in real-time with the notes you play on the guitar. You can specify the RY8 to "synthesize" any of the 50 normal voices as single notes, octaves, harmonies and more—in order to create interesting and unique sound textures.

A MIDI Tone Generator

Connect an external MIDI keyboard or sequencer in order to play the RY8's AWM drum voices. You can specify the note table by which the different voices will be sounded.

2. RY8 SYSTEM STRUCTURE

The RY8 is primarily a powerful rhythm programmer, but with the added dimension of automatic backing accompaniment, song programming capability and a guitar synthesizer.

The key components that make up the RY8's operating system are the AWM voices, the drum kits, the patterns, and the songs. The main operating modes are Pattern Mode and Song Mode, each of which are made up of several "functions". Additional modes include Drum Kit Mode, External In Mode, System Mode, Tempo Mode, Mute Mode, Balance Mode and Transpose Mode.

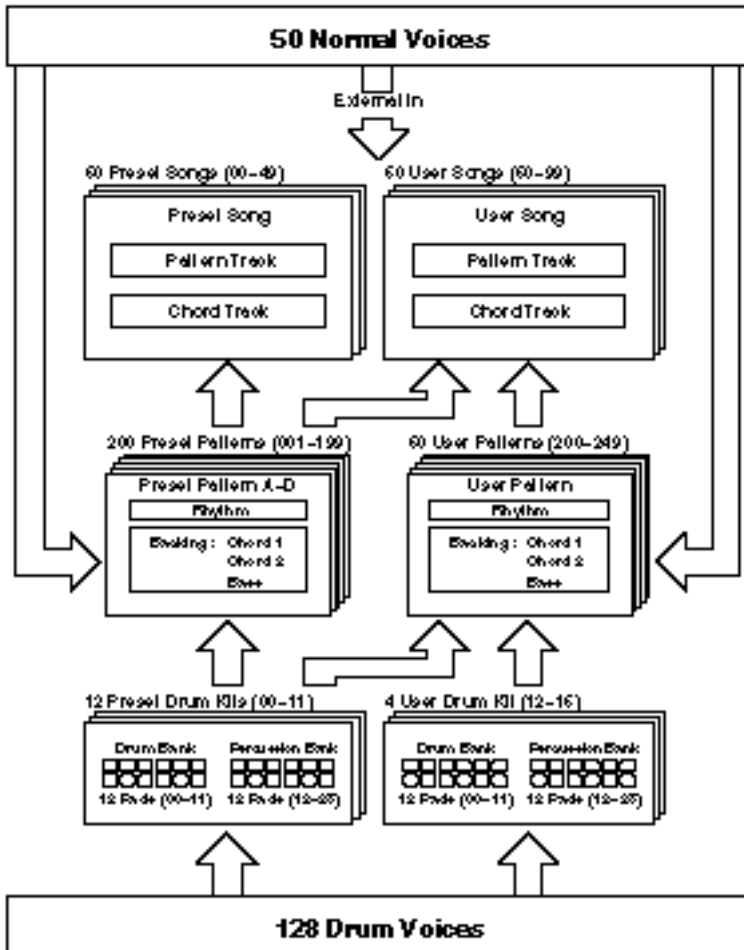



THE AWM VOICES.

There are 128 “drum” voices and 50 “normal” AWM voices. The drum voices are assigned to the drum kits. The normal voices are assigned to the backing accompaniments and to the guitar synthesizer.

THE DRUM KITS.

There are 12 Preset drum kits and 4 User drum kits. Although there are only 12 pads on the top panel of the RY8, each drum kit is made up of 24 drum voices, organized in two “Pad Banks”—a “Drum Pad Bank” and a “Percussion Pad Bank”—with 12 drum voices assigned to each Pad Bank. (You can switch freely back and forth between Pad Banks by pressing the [PAD BANK] button.)

The various Preset drum kits are designed for different styles of music. You can create your own User drum kits by assigning any drum voice you want to the pads, and specifying output and accent levels, as well as pan positioning and pitch tuning, for each pad.

THE PATTERNS.

There are 200 Preset patterns and 50 User patterns, each comprised of a one-measure rhythm pattern. The Preset patterns are organized in 50 music styles with “A”, “B”, “C” and “D” Sections for each style—representing both “main” and “fill-in” type Sections.

The Preset rhythm patterns also have special Bass, Chord 1 and Chord 2 backing accompaniment tracks—matched to the music style of each respective pattern—assigned to them. Each backing track can be turned off, or “muted”, at will, and you can adjust the volume balance of each. If you want, you can switch the backing off entirely.

You can create your own User rhythm patterns, and assign one of the backing accompaniments to it.

THE SONGS.

There are 50 Preset songs and 50 User songs. The Preset songs are made up of the Preset patterns, complete with preprogrammed chord progressions, and are intended as music style ideas to get you started or to play along with as they are.

You can create your own songs using Preset and/or User patterns, complete with chord progressions that you can record in the “chord track”.

THE MODES AND FUNCTIONS.

The RY8's features are for the most part organized into nine modes accessible by holding [MODE] and pressing one of the drum pads (the names of the modes are printed on the various pads).

All modes except Tempo Mode and Transpose Mode contain several pages of functions which you can select by holding [MODE] and pressing [PAGE-] and [PAGE+].

Most routine operations can be performed from either within Pattern Mode or Song Mode.

- To enter Pattern Mode, hold [MODE] and press [PATTERN].

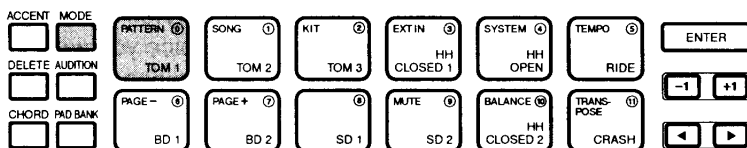

- To enter Song Mode, hold [MODE] and press [SONG].

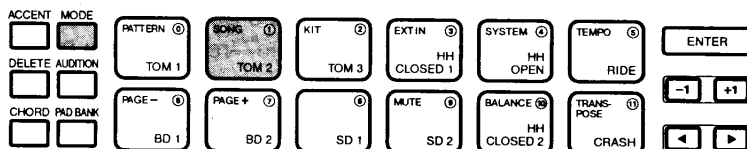

3. TOP PANEL

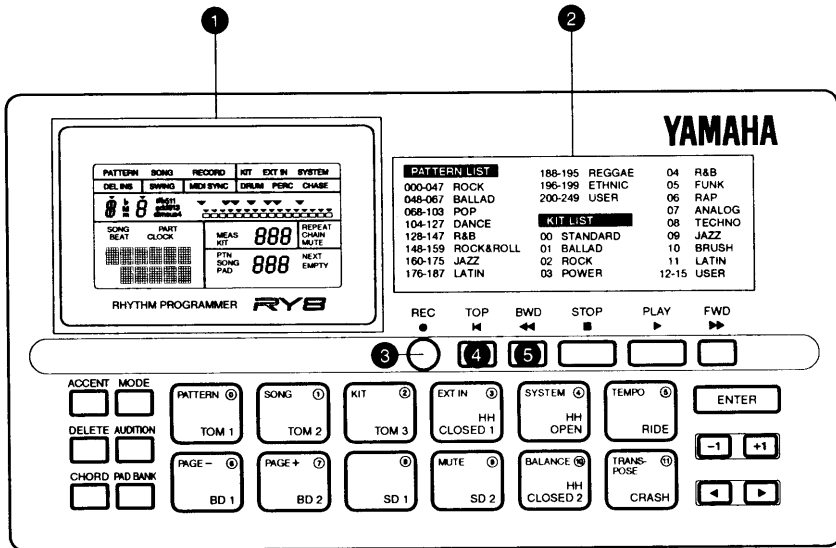

1 LCD SCREEN

High contrast, easy-to-read Liquid Crystal Display (LCD) provides large-content visual feedback to always let you know exactly what mode and status you're currently in.

2 PATTERN AND KIT LISTS

List of rhythm pattern and drum kit types arranged logically for quick reference and easy access.

3 [REC] BUTTON

For entering and exiting Pattern Record Mode and Song Record Mode. Both Step and Realtime recording are possible.

4 [TOP] BUTTON

For returning the song or pattern location to the top, or the first measure, when the playback is stopped.

5 [BWD] BUTTON

For rewinding the song through a series of measures when the song playback is stopped. Pressing [BWD] in Pattern Play Mode returns the pattern measure location to the top, or the first measure. Pressing [BWD] in Pattern Record Mode lets you select the clock position.

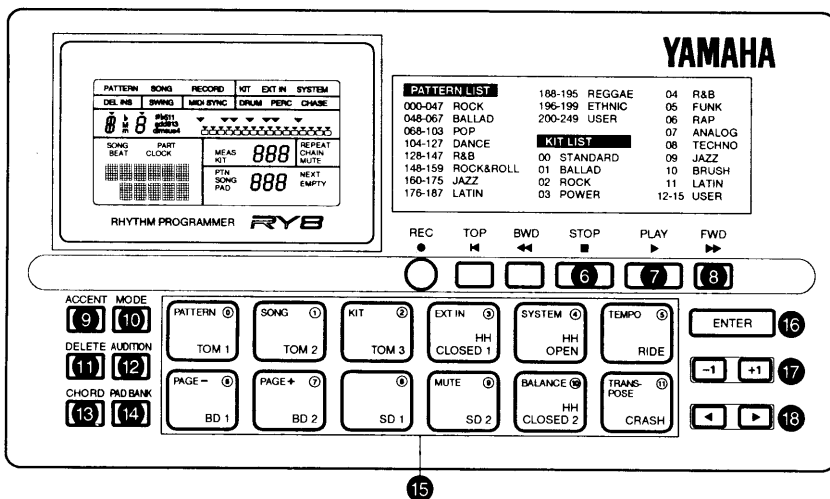

6 [STOP] BUTTON

For stopping the song or pattern playback or realtime recording.

7 [PLAY] BUTTON

For starting song or pattern playback or realtime recording from the current measure location. Pressing [PLAY] immediately after pressing [STOP] will continue the song or pattern playback from the stop location. To start the song or pattern from the beginning, or the top, press [TOP] before pressing [PLAY].

8 [FWD] BUTTON

For fast-forwarding the song through a series of measures when the song playback is stopped. Pressing [FWD] in Pattern Play Mode returns the pattern measure location to the top, or the first measure. Pressing [FWD] in Pattern Record Mode lets you select the clock position.

9 [ACCENT] BUTTON

For adding an accent to a drum beat, by pressing and holding [ACCENT] while hitting a drum pad. In Pattern Step Record Mode, you can record an accent by simply pressing [ACCENT] at the desired drum beat clock location. You can assign the accent level for each drum pad of a User drum kit in Drum Kit Mode.

10 [MODE] BUTTON

For accessing the various modes, by pressing and holding down [MODE] while pressing a mode button, and for accessing the various functions within each mode, by holding down [MODE] while pressing [PAGE-] and [PAGE+].

11 [DELETE] BUTTON

For deleting individual drum beats in Pattern Record Mode. Simply hold [DELETE] and press [ENTER] or the appropriate drum pad to delete the drum voice at the current cursor location. When Chord Assign is active, holding [DELETE] and pressing [ENTER] will delete the chord at the current cursor location.

12 [AUDITION] BUTTON

For “auditioning”, or checking, drum sounds in Pattern Step Record Mode before you record a drum beat. While pressing and holding [AUDITION], press the drum pad you want to audition and the drum voice will sound but data will not be input.

13 [CHORD] BUTTON

For accessing Chord Assign, which lets you specify the chord root and chord type for the backing.

14 [PAD BANK] BUTTON

Although there are only 12 drum pads on the top panel, each drum kit has 24 sounds, organized in two Pad Banks of 12 voices per bank. Pressing [PAD BANK] toggles between each bank of 12 “Drum” and 12 “Percussion” voices.

15 DRUM PADS/MODE BUTTONS

Double-function controls which act as drum pads for playing the drum voices during playback or recording, and act as mode and function select buttons when the [MODE] button is pressed and held. The names of the various modes are printed on the pads. The [PAGE+] and [PAGE-] buttons let you access the various functions within each mode. Although the drum pads are not touch sensitive, you can apply accents to drum beats using the [ACCENT] button.

16 [ENTER] BUTTON

For “confirming” or executing certain data entry operations.

17 [-1] AND [+1] BUTTONS

For specifying data, or modifying the currently selected parameters.

18 [◀] AND [▶] BUTTONS

For moving the “flashing cursor” around the LCD screen to select the various parameters.

4. SIDE & REAR PANELS

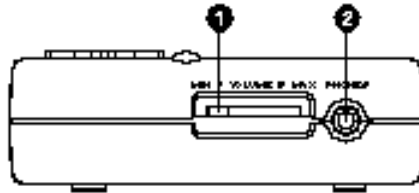

1 [VOLUME] SLIDER

For setting the master volume output level from the [OUTPUT] and [PHONES] jacks.

2 [PHONES] MINI JACK

For plugging in a pair of headphones with a mini stereo plug for private listening.

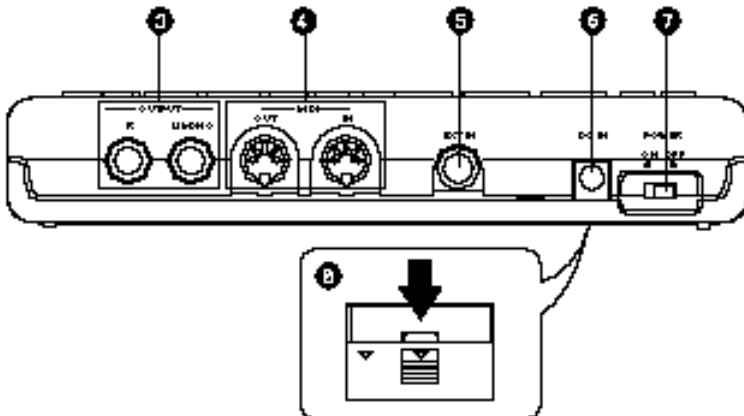

3 [OUTPUT] JACKS

For connecting the RY8 to a mixer, or a stereo amplifier, or amplified speakers. In the case of mono output, use the [L/MONO] jack.

4 [MIDI] JACKS

For connecting the RY8 to other MIDI devices such as a synthesizer or music sequencer, or to a MIDI data storage device (or another RY8) for bulk dumping of User song, pattern and kit data.



⑤ [EXT IN] JACK

For plugging in a guitar to play along with the song or pattern playback, or for using the guitar tuner feature, or for “triggering” any of the 50 AWM backing instrument voices in various ways.

⑥ [DC IN] JACK

For connecting an AC power adaptor to supply power to the RY8.

⑦ [POWER] SWITCH

For switching the RY8 on and off. Be sure to switch the power off when the RY8 is not in use.

⑧ BATTERY COMPARTMENT

For inserting six 1.5 volt AA-size (SUM-3 or R6P) batteries to supply power to the RY8. Be sure to remove the batteries when the RY8 is not to be used for an extended period of time.

GETTING STARTED

5. SETUP & POWER-ON

The RY8 can be powered by either an optional AC adaptor or six batteries. Follow the instructions below based on the power source you intend to use.

USING A POWER ADAPTOR.

Plug the DC output cable from an optional Yamaha PA-3 or PA-1B AC Adaptor (available from your Yamaha dealer) snugly into the [DC IN] jack on the rear panel, then plug the adaptor into a convenient wall AC power outlet.

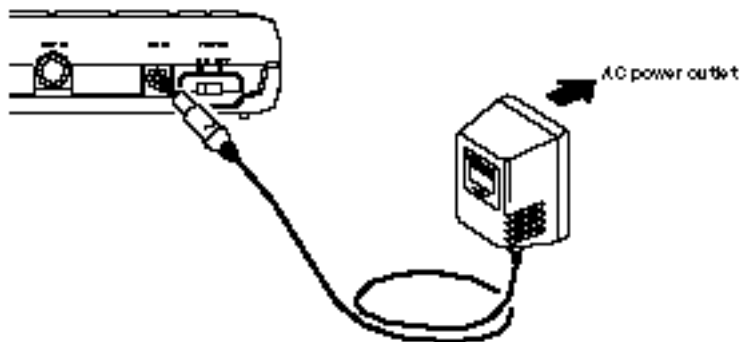

Do not attempt to use an AC adaptor other than the Yamaha PA-3 or PA-1B. The use of an incompatible adaptor may cause irreparable damage to the RY8, and may even pose a serious shock hazard! ALWAYS UNPLUG THE AC ADAPTOR FROM THE AC POWER OUTLET WHEN THE RY8 IS NOT IN USE.



When the AC adaptor plug is inserted into the RY8's [DC IN] jack, the batteries are automatically disconnected.

USING BATTERIES

Install six 1.5 volt AA-size (SUM-3 or R6P) or equivalent manganese or alkaline batteries into the battery compartment.

1. Open the battery compartment cover. Open the battery compartment cover—located on the bottom panel of the RY8—by carefully pressing down on the grooved area of the cover and sliding it outward, in the direction of the arrow as indicated on the cover itself, and as shown below.

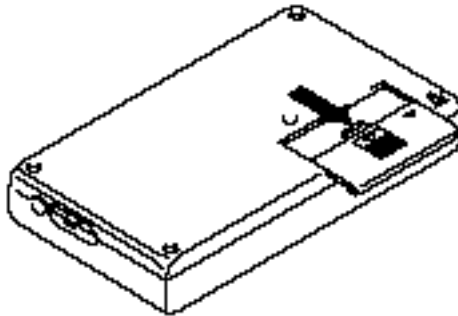

2. Insert the batteries. Insert the six batteries, being careful to position them according to the polarity markings as indicated on the bottom panel of the RY8.

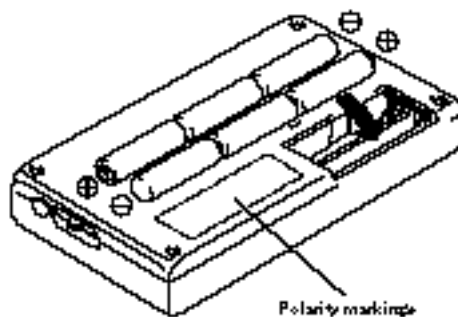

3. Replace the cover. Carefully replace the compartment cover, making sure that it locks snugly into place.

WHEN TO REPLACE THE BATTERIES.

When the batteries run down and are no longer able to operate the RY8, the sound may become distorted, the output volume level will decrease automatically, and the words "BATT LOW" will appear in the LCD.

When this happens, replace the batteries with a complete set of six new batteries **WARNING!** NEVER MIX OLD AND NEW BATTERIES, AND NEVER MIX DIFFERENT TYPES OF BATTERIES (SUCH AS ALKALINE AND MANGANESE)!



To prevent possible damage due to battery leakage, remove the batteries from the RY8 if the instrument is not to be used for an extended period of time.

CONNECTING EXTERNAL DEVICES.

Depending on your individual requirements, there are a variety of ways to connect external devices to the RY8.

Monitoring by Headphones

The simplest way to monitor the RY8's sound is to plug a set of headphones with a miniature stereo phone plug into the RY8's [PHONES] jack, and adjust the [VOLUME] slider.

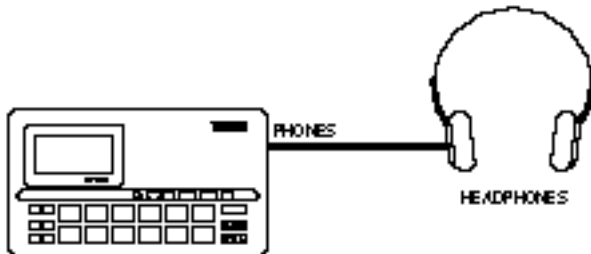

Monitoring by an Audio System

Another simple setup for monitoring the RY8's sound is to plug a pair of audio cables from the RY8's [OUTPUT] jacks to the inputs of either a mixer, or a stereo amplifier, or a pair of amplified keyboard speakers. Carefully adjust the RY8's [VOLUME] slider in relation to the input and output levels on the mixer and volume level on the amplifier.

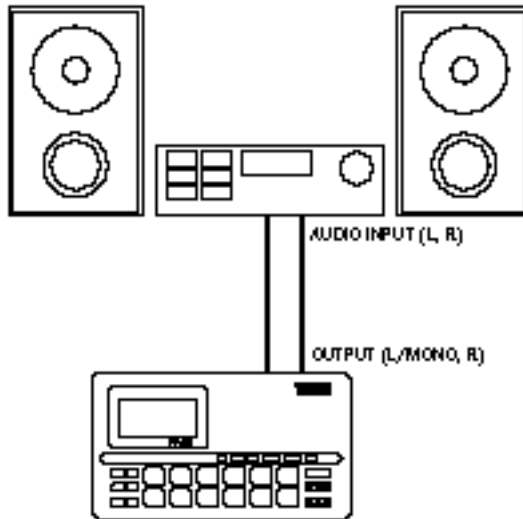

MAKE SURE BOTH THE RY8 AND YOUR SOUND SYSTEM ARE TURNED OFF WHEN MAKING CONNECTIONS !

Connecting a MIDI Device

The RY8 has a variety of MIDI capabilities, and the type of external MIDI device you connect to it depends on your particular requirements. For example, you may want to connect a MIDI data storage device (such as the Yamaha MDF2 MIDI Data Filer) to save User patterns, songs and drum kits, or you may want to connect an external MIDI keyboard to use the RY8 as a “slave” tone generator and play its AWM drum voices, or you may want to connect a music sequencer and control the RY8's sync clock. In general, you should plug a MIDI cable from the RY8's [MIDI OUT] jack to the MIDI IN jack of the external device, and plug another MIDI cable from the RY8's [MIDI IN] jack to the MIDI OUT jack of the external device. Depending on your required application, you may need to make specific MIDI settings on both devices. (For details about MIDI and sync clock settings, see “System Mode”, page 67.)

MIDI settings

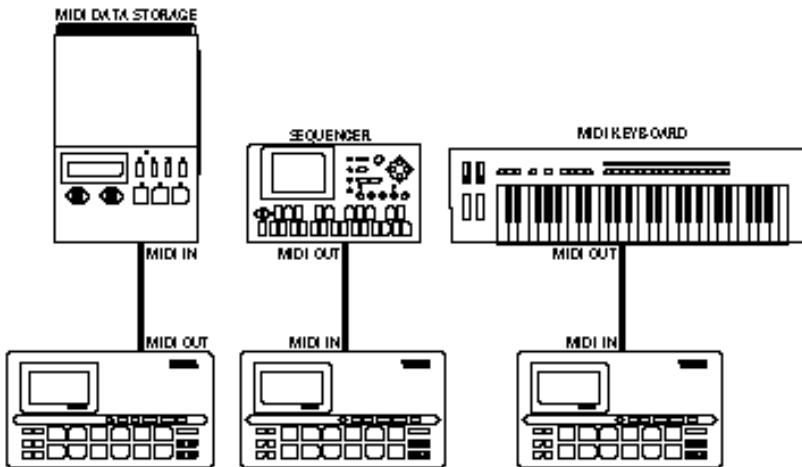

Connecting a Guitar

One of the RY8's most unique features is its [EXT IN] jack, which lets you plug a guitar directly into the RY8 and play along with the patterns and songs, or use the RY8 as a guitar tuner, or even use the RY8 as a guitar synthesizer to "trigger" one of the 50 AWM normal voices by the notes you play on the guitar. Turn down the volume of both the guitar and RY8, then plug a guitar cable from the guitar's output jack to the RY8's [EXT IN] jack. Next, raise the RY8's volume level, then turn up the guitar's volume knob. (For details about the EXT IN features, see "External In Mode", page 61.)

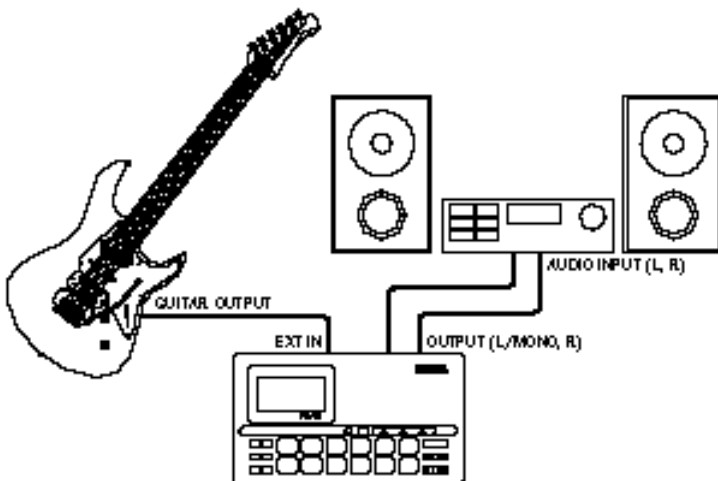

POWER-ON PROCEDURE.

There is actually a correct process for switching the various components in an electronic music system on and off. The rules are simple but important.

BEFORE TURNING ANYTHING ON:

- Be sure that all components are actually plugged in, and check to make sure that all volume controls are turned down to their zero positions.

- Always turn the RY8 on first (followed by any additional devices which may be connected).

- Always turn the sound system on last.

- Raise the sound system volume to a reasonable level.

- Gradually raise the RY8 volume while playing the drum pads to set the desired listening level.

When turning the various components off, simply reverse the process. The reason for turning the RY8 on first and off last is to avoid the possibility of sending a power surge through the sound system which could damage the amplifier or speakers.



6. PLAYING THE DEMO SONG

Before you begin using the RY8 or diving into its many features, you might want to hear the preprogrammed demo song which will give you an idea of just how powerful the RY8 is. To select the demo song, first you must enter Song Mode.

- To enter Song Mode, press and hold the [MODE] button, then press [SONG].

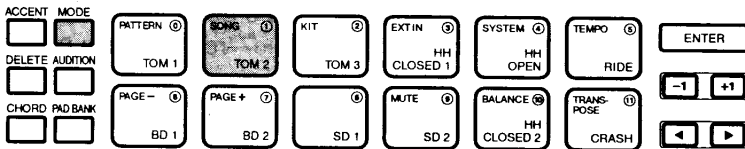

- To select the demo song, in the Song Select function, press and hold [+1] to scroll the song numbers all the way to the end—until the word “DEMO” appears in the lower left area of the LCD.

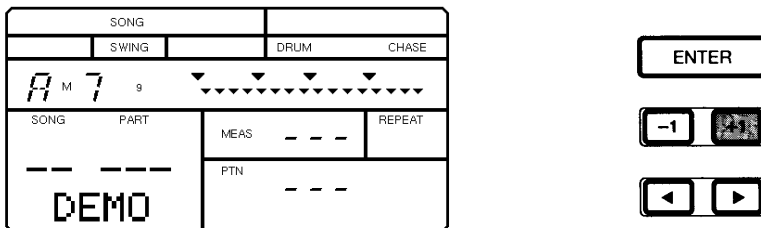

- To start the demo song playback, press [PLAY].
- To stop the demo song playback, press [STOP]. Pressing [PLAY] again will continue the demo song from the song stop location.

7. PLAYING THE DRUM PADS

At power-on, you can start hitting the drum pads right away. Try listening to the sounds of the currently selected drum kit.

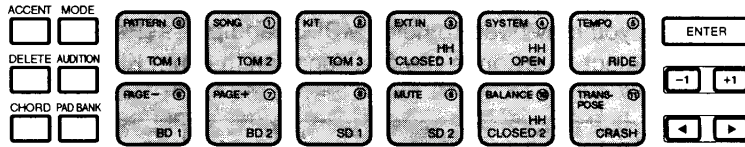

The Drum Voice List and Drum Kit List are provided on page 82 and 84.

SELECTING THE PAD BANKS.

Each of the twelve drum pads has two drum voices assigned to it. These are organized in “Drum” and “Percussion” Pad Banks.

- To switch back and forth between the two Pad Banks, press [PAD BANK].
- Either the word “DRUM” (for Drum Pad Bank) or the word “PERC” (for Percussion Pad Bank) will appear in the LCD screen as you switch back and forth between each.

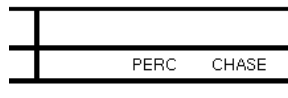
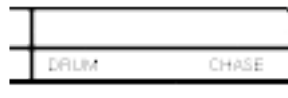
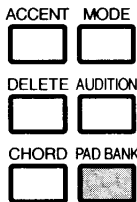

SELECTING THE DRUM KITS.

When the Chase function is on, the currently selected drum kit will depend on which pattern is selected. There are 16 drum kits—12 Preset drum kits and 4 User drum kits. To select a different kit, you must first enter Drum Kit Mode.

- To enter Drum Kit Mode, hold [MODE] and press [KIT]. (To access the Kit Select function, you may need to hold [MODE] and press [PAGE-] several times; the Kit Select function is the first function in Drum Kit Mode.)

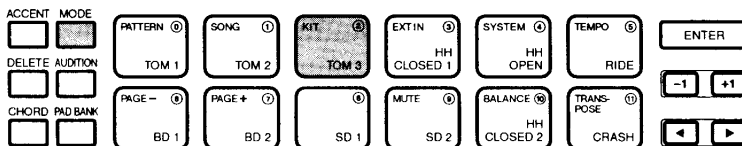

- The word “SELECT” will appear on the LCD, as will the name of the currently selected drum kit. The kit number (00 ~ 15) will also display in the LCD.
- To select a different drum kit, press [-1] and [+1]. Kits #00 ~ #11 are Preset drum kits, and kits #12 ~ #15 are User drum kits.

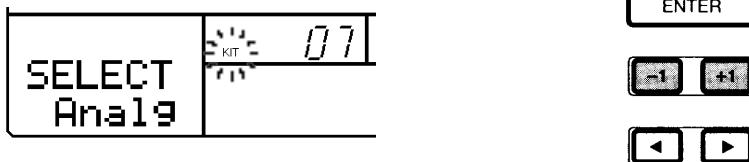

When shipped, the Preset drum kits #00 ~ #03 are assigned to User drum kits #12 ~ #15, respectively. For a listing of the 16 drum kits and respective drum pad voice assignments, see page 84.

8. PLAYING THE PRESET PATTERNS

The RY8 comes filled with 200 Preset one-measure rhythm patterns (#000 ~ #199). Each Preset pattern is accompanied by a special backing part, preprogrammed in a specific music style. The automatic backing consists of Bass, Chord 1 and Chord 2 tracks. There are 200 backings, covering many different popular styles of music. (For a list of the RY8's pattern, see page 86.)

The Preset rhythm patterns are organized in 50 music styles with four Sections for each style. A Section is simply a "Main A" or "Main B" part, or a "Fill AB" part (a fill-in that leads the Main A part naturally into the Main B part), or a "Fill BA" part (a fill-in that leads the Main B part naturally into the Main A part).

You can change the backings independently of the rhythm (see page 32), as well as change the chord (see page 32). You can mute the various backing tracks (see page 74), or turn the backing off entirely and just hear the rhythm (see page 32).



All changes made to Preset patterns, except for the Swing setting, are temporary. When you select a different pattern or switch to another mode and then return to Pattern Mode, the default settings will be reinstated.

- To select a Preset pattern, first enter Pattern Mode by holding [MODE] and pressing [PATTERN].

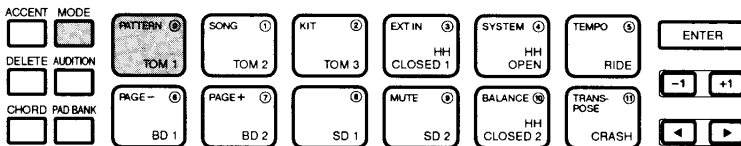

(It may be necessary to hold [MODE] and press [PAGE-] several times to access the Pattern Select function; Pattern Select is the first function in Pattern Mode.)

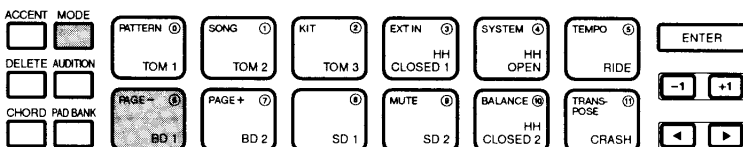

ORIGINAL DESIGN

■ The word “PTN” (located next to the number of the currently selected pattern) will be flashing, indicating that you can change the pattern number.

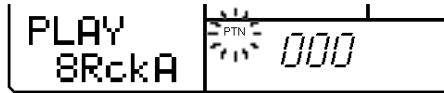

■ Press [-1] and [+1] to select a Preset pattern (between #000 ~ #199). (The pattern numbers between #200 ~ #249 are for User patterns, i.e., patterns you create yourself; the User patterns for a new RY8 will contain no data.)

■ To play the selected Preset pattern, press [PLAY]. The selected pattern will play repeatedly until you press [STOP]. To continue the pattern playback from the stop position, press [PLAY] again. To start the pattern again from the beginning, or top, before pressing [PLAY], you must press [TOP], [BWD] or [FWD] to return the pattern to the top.



SELECTING “NEXT” PATTERNS.

While a pattern plays back, you can designate the “Next” pattern to play immediately after the current pattern finishes.

■ To select the Next pattern, while the current pattern is playing, simply press [-1] and [+1] to designate the Next pattern. (This is a good opportunity to step through each Preset pattern and hear each one!)

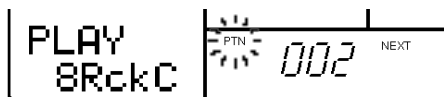

CHANGING THE TEMPO.

You can change the tempo whether the pattern is playing or stopped. Each Preset pattern is programmed with an “initial tempo”. When you select a pattern, the pattern’s initial tempo will be loaded.

- To change the current tempo setting, hold [MODE] and press [TEMPO] to enter Tempo Mode.

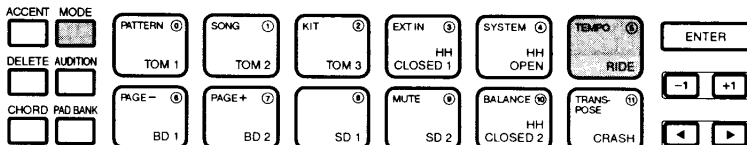

The word “TEMPO” will display in the lower left area of the LCD, and the current tempo value will be flashing. Press [-1] and [+1] to specify a new tempo value. The playback tempo can be set to any value from 40 to 250 beats per minute.

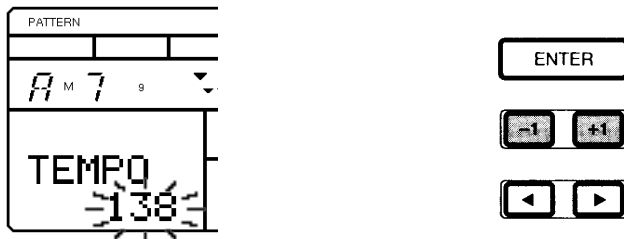

- To exit Tempo mode hold [MODE] and press [PATTERN].

CHANGING THE BACKING CHORD.

You can change the chord root and chord type for the backing while the pattern is stopped or while it is playing. All backing tracks will automatically change to play in the designated chord.

- To change the backing chord, you must first select Chord Assign by pressing [CHORD]. A small, flashing black inverted triangle indicator will appear above the Chord Root in the upper left area of the LCD.

ORIGINAL DESIGN

- To select Chord Root or Chord Type, press [◀] and [▶]. The flashing indicator will be positioned above the currently selected one.
- To change the backing Chord Root or Chord Type, press [+1] and [-1], followed by [ENTER] to lock in the new chord.

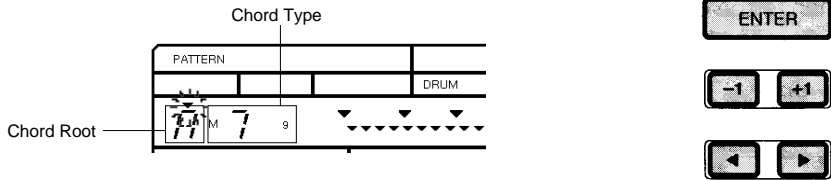

- To exit Chord Assign, press [CHORD] again.

SELECTING THE BACKING ACCOMPANIMENT.

The backing accompaniments consist of Bass, Chord 1 and Chord 2 tracks, preprogrammed to match the relevant Preset patterns. You cannot modify a backing, but you can select a different backing to temporarily play with the currently selected pattern.

- To select a backing accompaniment, within the Pattern Mode Pattern Select function, press [◀] to move the flashing cursor over the backing name in the LCD; the backing name will begin flashing, indicating that you can select a different backing accompaniment to play with the currently selected rhythm. (This is a good opportunity to hear how the different backings sound with different rhythms!)

- When the backing name is flashing, press and hold [-1] or [+1] to scroll through all the backings; the very last backing selection will be the “Backing Off” status.

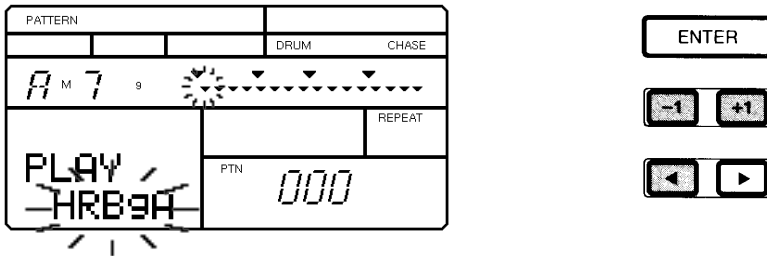

- To turn the backing accompaniment off, choose the very last backing selection, indicated by the words “BKOFF” in the LCD. (To turn the backing on again, press [-1] and specify a desired backing.)

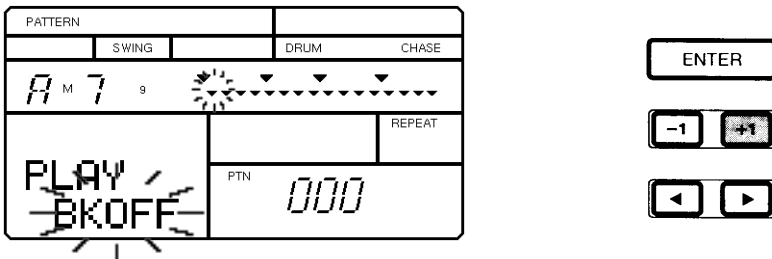

MUTING THE BACKING TRACKS.

You can mute (i.e., switch off) any or all of the backing tracks. You must first enter Mute Mode by holding [MODE] and pressing [MUTE].

- To select and mute the Bass, Chord 1 or Chord 2 track, hold [MODE] and press [PAGE-] or [PAGE+].

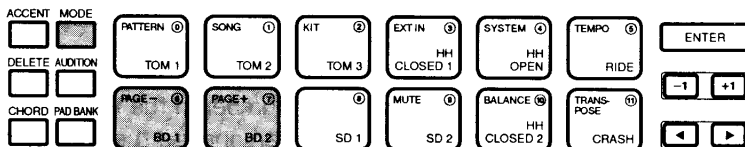

ORIGINAL DESIGN

Bass Track Mute (“B”) is the first function, Chord 1 Track Mute (“C1”) is the second function, and Chord 2 Track Mute (“C2”) is the third function in Mute Mode. The words “MUTE B (or C1 or C2) OF” will appear on the LCD to indicate that you have accessed the desired Track Mute function, and that it is turned off. To turn it on, press [+1]. The word “ON” will appear in the LCD, and the track will stop playing. (To turn the track Mute function off again, press [-1].)



■ To exit Mute mode, hold [MODE] and press [PATTERN].

9. PLAYING THE PRESET SONGS

The Preset songs are intended as music style ideas to get you started, or to play along with as is. There are 50 Preset songs (#00 ~ #49), covering many different popular styles of music.

■ To select a Preset song, first enter Song Mode by holding [MODE] and pressing [SONG]. Next, hold [MODE] and press [PAGE-] once or more to access the Song Select function; Song Select is the first function in Song Mode.

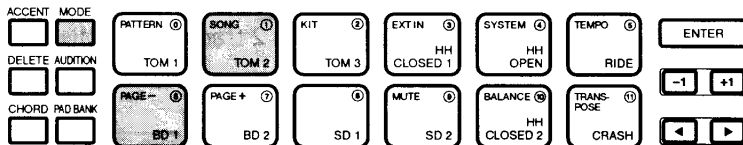

■ The word “SONG” (located above a two-digit number in the lower left area of the LCD) will be flashing, indicating that you can change the song number.

- Press [-1] and [+1] to select a Preset song (between #00 ~ #49). (The song numbers between #50 and #99 are for User songs, i.e., songs you create yourself; the User songs for a new RY8 will contain no data.)

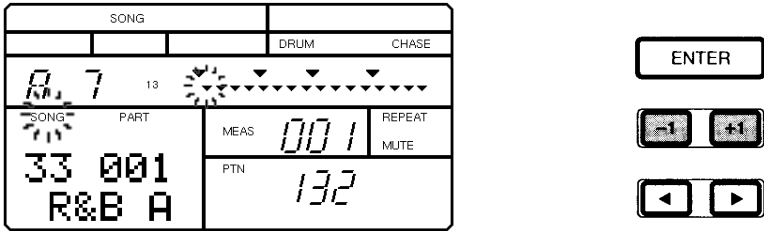

- To play the selected Preset song, press [PLAY]. (If the Repeat function is on; see page 43), the song will continuously play until you press [STOP].
- To stop the playback in the middle of a song, press [STOP]. To continue the song playback from the stop position, press [PLAY] again. To start the song playback from the top, press [TOP] before pressing [PLAY].



- To specify a starting measure, before pressing [PLAY], press [BWD] or [FWD] to designate a specific measure to start the song from.



The RY8 has 28-note polyphony, which means the maximum number of notes that can sound at one time is 28. In some cases, some of the voices may be "truncated", or cut off, or may not sound at all.

ORIGINAL DESIGN

CHANGING THE PATTERNS AND BACKING ACCOMPANIMENT.

You can easily change the patterns and backing accompaniment of the selected song—either while the song is stopped or while it is playing.

After you've switched into the Song Mode Song Select function and selected a song, when you press [PLAY] to start the song playback, the flashing cursor position will change from "SONG" (in the lower left area of the LCD) to "PTN" (Pattern; in the lower right area of the LCD). This indicates that you can change the pattern.

When you change the pattern number, the pattern will change, and the accompaniment backing will change accordingly.

- To change the pattern, either start the playback or press [▶] once or more to position the flashing cursor over the word "PTN" (Pattern). Then press [-1] and [+1] to select a rhythm pattern.

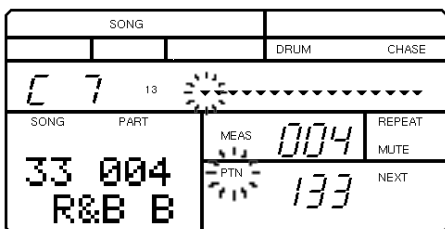

- To change the backing accompaniment, press [◀] or [▶] to position the flashing cursor over the name of the backing accompaniment. The backing name will begin flashing, indicating that you can select a different accompaniment backing to play with the currently selected rhythm. Then press [-1] and [+1] to select a backing accompaniment.

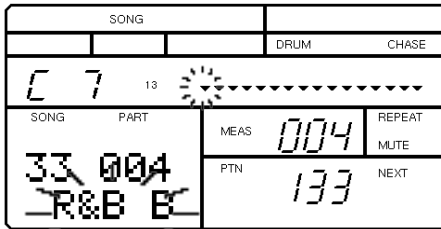

The pattern and backing changes you make in the Preset song will only remain active as long as the current Preset song is selected, or until you select a different measure by pressing [TOP], [BWD] or [FWD]. When you select another song, the Preset default patterns will be reinstated.

CUSTOMER SERVICE

MODES & FUNCTIONS

10. PATTERN MODE

Pattern Mode is one of the two main operating modes of the RY8 (the other being Song Mode). It consists of both Pattern Play and Pattern Record Modes.

The Preset Pattern List is provided on page 86.

PATTERN PLAY MODE.

In Pattern Play Mode, you can select and play Preset and User patterns, as well as assign a Swing factor to a pattern, clear a User pattern, copy a Preset or User pattern into a User pattern location, and assign a backing to a User pattern.

- **ENTERING PATTERN PLAY MODE** - Hold [MODE] and press [PATTERN] to enter Pattern Play Mode.

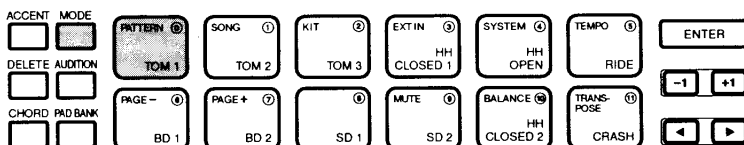

- **SELECTING A FUNCTION** - Hold [MODE] and press [PAGE+] and [PAGE-] to step through the various functions. The LCD will display information about the status of each function as you step through them.

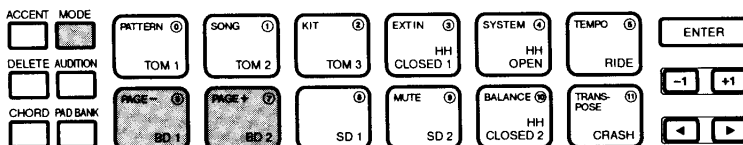

THE BEAT/CLOCK POSITION INDICATORS

The pattern beat/clock position indicators appear in the upper right area of the LCD, where large inverted triangles represent each beat in the measure, and small inverted triangles represent each clock where rhythm data may exist. (The number of beat and clock position triangles in the measure depends on the designated meter of the pattern.)

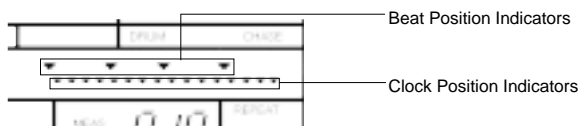

During playback, each beat position indicator flashes according to the current beat location, with all beat positions flashing on the first beat of the measure. Each clock position indicator flashes according to the current clock location.

■ **SELECTING A PATTERN** - Position the flashing cursor over the word "PTN", then press [+1] and [-1] to select a Preset (#000 ~ #199) or User (#200 ~ #249) pattern.

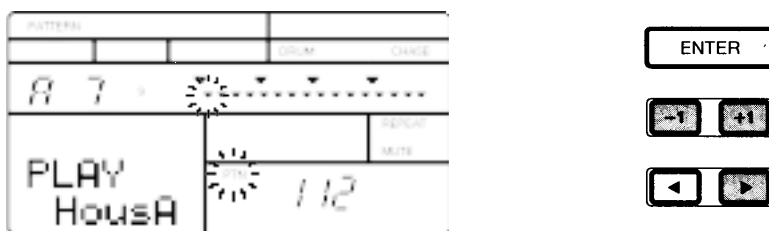

■ **STARTING AND STOPPING THE PATTERN PLAYBACK** - Press [PLAY] to start the pattern playback. Press [STOP] to stop the pattern playback. Pressing [PLAY] again will continue the pattern playback from the stop position.

■ **DESIGNATING THE TOP OF THE PATTERN** - When the playback is stopped, press [TOP], [BWD] or [FWD] to designate the top of the measure. Then, pressing [PLAY] will start the pattern playback from the top.

■ **SELECTING A “NEXT” PATTERN** - To specify the “Next” pattern to play immediately after the current pattern finishes, press [+1] and [-1] while the current pattern is playing to specify the Next pattern number. The word “NEXT” will display in the LCD until the Next pattern is engaged.

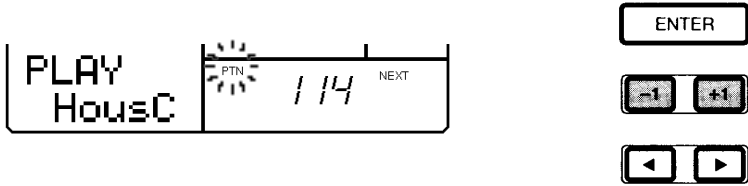

■ **CHANGING THE BACKING** - To temporarily select a different backing to hear how it sounds with the current rhythm pattern (either while the pattern is playing or is stopped), press [◀] once to position the flashing cursor over the backing name. Then press [+1] and [-1] to select one of the 200 backing accompaniments. The very last selection on the list is “BKOFF”, which lets you turn the backing off.

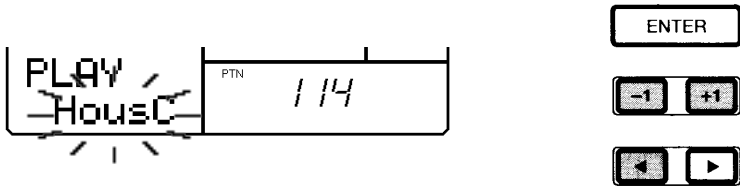

■ **CHANGING THE CHORD** - To temporarily specify a different chord for the backing, press [CHORD] to activate Chord Assign. Press [◀] to place the cursor over the Chord Root display, and press [+1] and [-1] to specify the chord root. Press [▶] to place the cursor over the Chord Type display, and press [+1] and [-1] to specify the chord type. Then, press [ENTER] to register the chord type change. Press [CHORD] again to exit Chord Assign. (For a list of the Chord types, see page 51.)

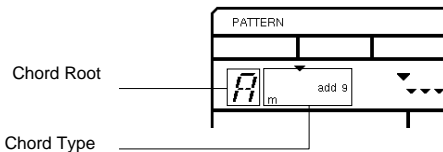

■ ASSIGNING A SWING FACTOR TO THE PATTERN - Hold [MODE] and press [PAGE-] or [PAGE+] once or more to access the Swing function. The word "SWING" will appear in the LCD, as will the current Swing setting (OFF, E1 ~ E9, S1 ~ S5). To assign a Swing factor to the currently selected pattern, press [-1] or [+1]. The Swing setting also affects the backing accompaniment. When a Swing setting is assigned to a pattern, whenever the pattern is selected, the word "SWING" will appear in the upper area of the LCD.

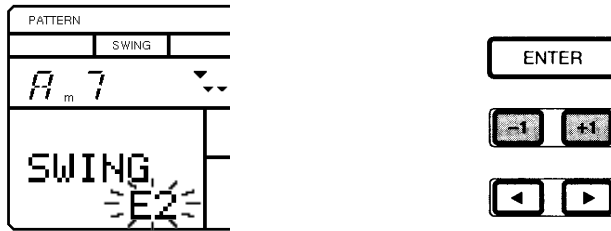

There are two types of Swing factors. "E" factors represent 8-beat, and "S" factors represent 16-beat. Depending on the selected Swing type or selected patterns, the Swing function may not produce an apparent effect.

■ CLEARING A USER PATTERN - When the pattern is stopped, hold [MODE] and press [PAGE-] or [PAGE+] to access the Pattern Clear function. The words "CLEAR SURE?" will appear in the LCD. Press [-1] and [+1] to select a User pattern number (#200 ~ #249). Then, press [ENTER] to clear the data from the pattern. The word "EMPTY" will appear beside the pattern number in the LCD. (To exit the Clear function, hold [MODE] and press [PAGE-].) If the word "PRESET" temporarily appears in the LCD when you press [ENTER], this means

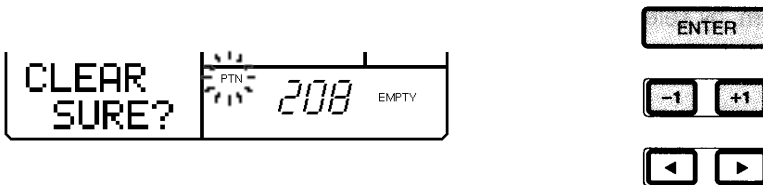

you are attempting to clear a Preset pattern. If this happens, simply select a User pattern number (#200 ~ #249) and try again.

MODEL & FUNCTION KEY

■ **COPYING THE CURRENTLY SELECTED PATTERN** - When the pattern is stopped, first select a source pattern to copy from. Then, hold [MODE] and press [PAGE+] once or more to access the Pattern Copy function. The words "COPY SURE?" will appear in the LCD. Press [-1] and [+1] to select a destination User pattern number (#200 ~ #249) where the currently selected Preset or User pattern will be copied to. Then, press [ENTER] to copy the pattern. (To exit the Copy function, hold [MODE] and press [PAGE-].)

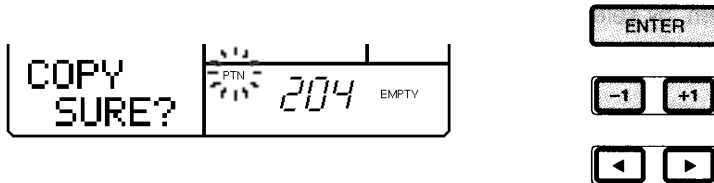

The data which is copied into the destination User pattern includes the initial tempo, the Swing setting, the drum kit, and the backing. If there is a pattern in the destination User pattern location which has a different meter than the pattern you are copying to, you cannot copy, and the words "TS NOT MATCH" will briefly appear in the LCD when you press [ENTER]. If this happens, clear the destination User pattern and then try the copy operation again.



If the LCD displays the words "MEMORY FULL", you must free up memory by clearing any unwanted User patterns or songs. (Be sure to save any important User data first, offloading it to an external storage device such as the Yamaha MDF2 MIDI Data Filer.)

■ **ASSIGNING A BACKING TO A USER PATTERN** - You can assign any of the 200 backing accompaniments to play with a User pattern. Hold [MODE] and press [PAGE-] once or more to access the Pattern Select function. Press [◀] to position the cursor over the backing name, then press [-1] and [+1] to select the backing you want. (You may also turn the backing off for the User pattern, by selecting "BKOFF").

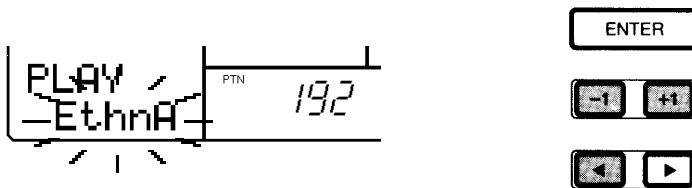

PATTERN RECORD MODE.

In Pattern Record Mode, you can select and record a User pattern in either step-time or real-time, as well as designate the meter (time signature) for the pattern before recording, and record accents to achieve realistic playing dynamics. You may copy a Preset pattern to a User pattern location and modify it, or you may clear a User pattern (or select an empty User pattern) and create your own pattern from scratch.



If the LCD displays the words “MEMORY FULL”, you cannot record a User pattern. To free up memory, clear any unwanted User patterns or songs. (Be sure to save any important User data first, offloading it to an external storage device such as the Yamaha MDF2 MIDI Data File.)

■ **ENTERING PATTERN RECORD MODE** - First hold [MODE] and press [PATTERN] to enter Pattern Mode. Then press [REC] to enter Pattern Record Standby Mode, which means the RY8 will be standing by ready to record—by either the Step or Realtime recording process—with the pattern beat/clock location conveniently cued up at the first beat of the measure. The LCD will display the current chord, the current beat, the current clock, the drum voice name of the currently selected drum pad, and the currently selected pad number. (To exit Pattern Record Mode, press [REC] again.)

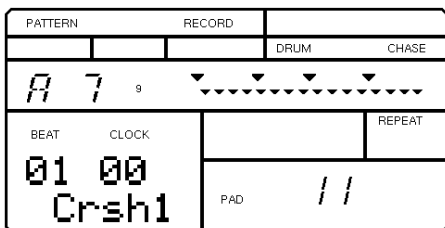

You cannot enter Pattern Record Mode when a Preset pattern (#000 ~ #199) is selected. If you press [REC] when a Preset pattern is selected, the word “PRESET” will appear briefly in the LCD to remind you to select a User pattern and then try again.

■ **DESIGNATING THE METER** - If you want to create a pattern from scratch with a specific time signature, you must first designate the meter for an empty User pattern while still in Pattern Record Standby Mode—i.e., before initiating the Step or Realtime recording operation. Hold [MODE] and press [PAGE+]. The default meter setting will be flashing. To designate a different meter, press [-1] and [+1]. To return to Record Standby Mode, hold [MODE] and press [PAGE-].

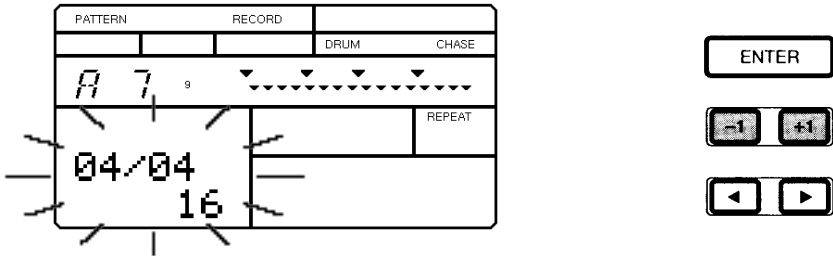

ASSIGNING THE TIME SIGNATURE

You cannot change the time signature for an existing pattern. You can only assign a time signature to an empty User pattern. You can designate both time signature and quantization factors according to the following table:

Time Signature	Quantization Factors
01/04	12, 16, 24, 32
02/04	12, 16, 24, 32
03/04	12, 16
04/04	12, 16
05/04	12
01/08	16, 24, 32
03/08	16, 24, 32
05/08	16, 24
07/08	16
01/16	16, 32
03/16	16, 32
05/16	16, 32
07/16	16, 32
09/16	16
11/16	16
13/16	16
15/16	16

EXAMPLE DRUM SCORE: 8 BEAT PATTERN

When an 8 beat pattern is recorded, the LCD will display as follows.

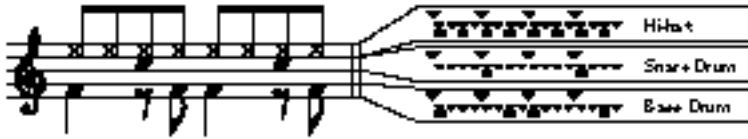

■ **ENTERING STEP RECORD MODE** - From within Pattern Record Standby Mode, simply pressing one of the drum pads or the [ACCENT] button will initiate the step recording operation. (To exit Step Record Mode, press [REC] again.)

■ **RECORDING IN STEP-TIME** - Step recording is simply locating the clock position indicator at a specific clock by pressing [FWD], [BWD] or [TOP], and then entering a drum beat in that location by pressing the desired drum pad. When you enter pad data, a small black square will display beneath the clock position to indicate data exists in that location for the currently selected pad, and the location of the clock position indicator will advance by one clock.

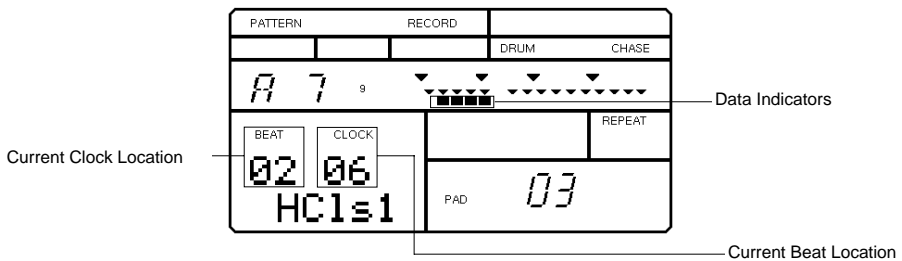

The RY8 automatically prevents the sounding of illogical drum notes—such as a closed and open high-hat playing at the same time. The drum voice assigned to the higher pad number will always take precedence.

■ **ENTERING REALTIME RECORD MODE** - From within Pattern Record Standby

Mode, simply pressing [PLAY] will initiate the realtime recording operation. A count-in metronome click will begin (the number of count-in beats will appear on the screen, and will depend on the designated meter), after which realtime recording will commence. (To exit Record Mode, press [STOP], then press [REC] again.)

■ **RECORDING IN REALTIME** - Realtime recording is simply hitting the desired drum pads after the count-in, in time with the metronome click. You can keep adding drum beats as the measure loops continuously. As you play, a small black square will display beneath the clock position indicator to indicate that data exists in that location for the currently selected pad. To stop the realtime recording procedure, press [STOP].

■ **AUDITIONING DRUM PADS** - In either Step or Realtime Record Mode, you can “audition” the drum pads without entering data. Hold [AUDITION] and press a drum pad to “select” it, or hear it.



The small black squares under the clock position indicators will not appear unless you have selected a drum pad with pattern data in it.



When pressing [FWD] and [BWD] to step through the clock positions, all data existing in each clock position will sound.

■ **DELETING PAD DATA** - In either Step or Realtime Record Mode, you can delete an unwanted drum beat. Hold [DELETE] and press the relevant drum pad at the desired clock location.



In Step Record Mode, there's also another way to delete an unwanted drum beat. First, audition the desired pad so that the black data squares for the pad appear beneath the clock position indicators in the LCD. Next, place the clock position indicator at the desired location. Then, hold [DELETE] and press [ENTER].

ADDING ACCENTS TO THE RHYTHM

You can record and delete accents the same way as recording and deleting drum beats—by using the [ACCENT] button. (You can assign accent levels to the pads for User drum kits. For details, see page 59.)

■ **ADDING AN ACCENT** - In Pattern Play Mode, you can add an accent as you play the pads in realtime, by holding [ACCENT] and pressing a drum pad. In Record Mode, pressing [ACCENT] will record an accent at the current clock position. The word “accnt” will appear on the LCD, indicating that you have accessed Accent Assign. (To exit Accent Assign, hold [AUDITION] and press any drum pad.)

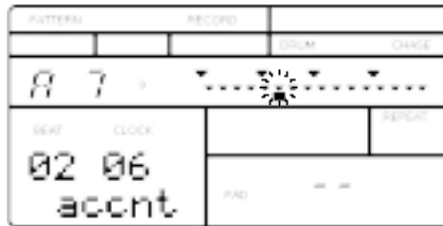

■ **AUDITIONING ACCENTS** - In either Step or Realtime Record Mode, you can audition the accents without entering accent data. Hold [AUDITION] and press [ACCENT] to visibly confirm the accentuated voices.

■ **DELETING ACCENT DATA** - In either Step or Realtime Record Mode, you can delete an unwanted accent by holding [DELETE] and pressing [ACCENT] at the desired clock location.



In Step Record Mode, there's also another way to delete an unwanted accent. First, audition the accent by holding [AUDITION] and pressing [ACCENT]. The black data squares representing the accent locations will appear beneath the clock position indicators in the LCD. Next, place the clock position indicator at the desired location. Then, hold [DELETE] and press [ENTER].

■ **ASSIGNING A BACKING** - You can assign any of the 200 backing accompaniments to play with a User pattern. (For details, see page 34.)

■ **EXCEEDING THE MAXIMUM NOTE POLYPHONY** - The RY8 has 28-note polyphony, which means the maximum number of notes that can sound at one time is 28. Depending on the pattern you have created, several drum beats may fall on a specific location where many bass and chord notes exist. Any drum beats that would exceed the 28-note capacity will be “truncated”, or cut off, or will not play.



Turning the power off while Pattern Record Mode is active, or while the pattern Copy or Clear function is being executed, may cause the irretrievable loss of all User data.

11. SONG MODE

Song Mode is one of the two main operating modes of the RY8 (the other being Pattern Mode). It consists of both Song Play and Song Record Modes.

SONG PLAY MODE.

In Song Play Mode, you can select and play Preset and User songs, as well as turn the Repeat and Chain functions on and off, clear a User song, and copy a Preset or User song to a User song location.

■ **ENTERING SONG PLAY MODE** - Hold [MODE] and press [SONG] to enter Song Play Mode.

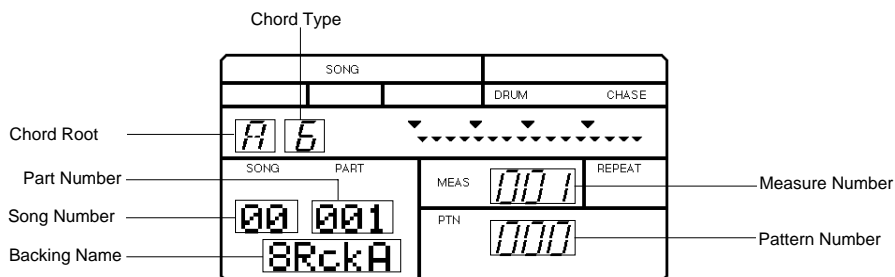
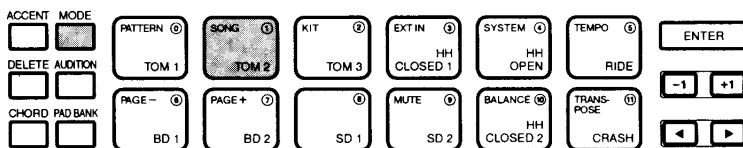

The LCD will display information about the Song Select function, including current song and part number, the backing name, pattern number, measure number and Chord.



When a User song is empty, dashes (---) will be displayed in the LCD areas for the current backing name and pattern number.

RHYTHM & PERFORMANCE

■ **SELECTING A FUNCTION** - Hold [MODE] and press [PAGE+] and [PAGE-] to step through the various functions. The LCD will display information about the status of each function as you step through them.

■ **SELECTING A SONG** - When you enter Song Play Mode, you can go ahead and select a song. Otherwise, you must position the flashing cursor over the word "SONG" by pressing [◀]. Then, press [+1] and [-1] to select a Preset (#00 ~ #49) or User (#50 ~ #99) song, or the Demo song. (While the song is stopped, you can press [◀] and [▶] to position the flashing cursor over the song number, backing name or pattern number.)

■ **STARTING AND STOPPING THE SONG PLAYBACK** - Press [PLAY] to start the song playback. Press [STOP] to stop the song playback. Pressing [PLAY] again will continue the song playback from the stop position.

■ **DESIGNATING THE SONG START MEASURE** - When the song playback is stopped, press [TOP] to designate the top of the song, or press [BWD] or [FWD] to designate a particular measure. Then, pressing [PLAY] will start the song playback from the designated measure.



To step through each measure one-by-one, press [BWD] or [FWD] once or more. To scroll through a series of measures, press and hold [FWD] or [BWD], respectively.

■ **CHANGING THE BACKING** - To temporarily select a different backing to hear how it sounds with the current rhythm pattern (even while the song is playing), press [◀] or [▶] to position the flashing cursor over the backing name. Then press [+1] and [-1] to select one of the 200 backing accompaniments. The very last selection on the list is "BKOFF", which lets you turn the backing off.

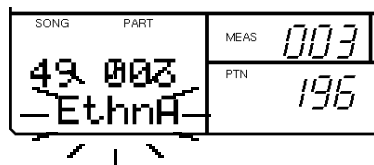

■ **CHANGING THE PATTERN** - To temporarily specify a different pattern to hear how it sounds with the song, press [◀] or [▶] to position the flashing cursor over the abbreviation “PTN” (Pattern). Then press [+1] and [-1] to specify the pattern number.

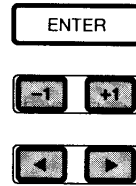
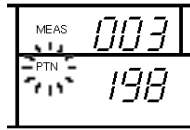

Any changes made to the pattern or backing in Song Play Mode will only be effective temporarily. When you press [TOP] to locate the top of the song, or press [FWD] or [BWD] to select a starting measure, the original patterns and backings for the song will be reinstated. Likewise, if you exit Pattern Mode, when you return to Pattern Mode or select another song, the original patterns and backings for the particular song will be reinstated.

■ **TURNING THE REPEAT FUNCTION ON AND OFF** - When the Repeat function is turned on, the currently selected song will play continuously until you press [STOP]. Hold [MODE] and press [PAGE-] or [PAGE+] to access the Repeat function. The word “REPEAT” will appear in the lower left area of the LCD, along with the current Repeat status—“ON” or “OFF”. Press [+1] to turn the Repeat function on. Press [-1] to turn it off.

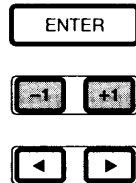
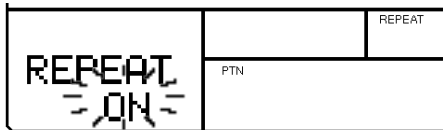

■ **TURNING THE CHAIN FUNCTION ON AND OFF** - The Chain function is handy for setting up a series of User songs to play one after another. When the currently selected User song reaches the end, the subsequent User songs will automatically play—one after the other, in numeric order—until an empty User song is encountered, or until the last song is finished, or until you press [STOP]. Hold [MODE] and press [PAGE-] or [PAGE+] to access the Chain function. The word “CHAIN” will appear in the lower left area of the LCD, along with the current Chain status—“ON” or “OFF”. Press [+1] to turn the Chain function on. Press [-1] to turn it off.



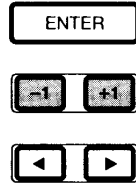
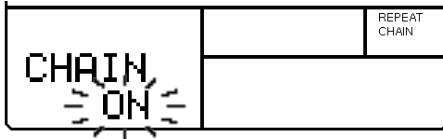

If you turn both the Repeat and Chain functions on and then press [PLAY], the User songs will play from the top to the end repeatedly, until you press [STOP].

■ **CLEARING A USER SONG** - When the song is stopped, hold [MODE] and press [PAGE-] or [PAGE+] to access the Song Clear function. The words "CLEAR SURE?" will appear in the LCD. Press [-1] and [+1] to select a User song number (#50 ~ #99). Then, press [ENTER] to clear the data from the song. When the song is cleared, the word "EMPTY" will appear beside the song number in the LCD. (To exit the Clear function, hold [MODE] and press [PAGE-].)

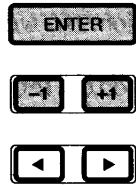
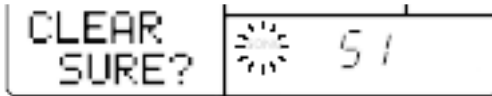

If the word "PRESET" temporarily appears on the LCD when you press [ENTER], this means you are attempting to clear a Preset song. If this happens, simply select a User song number (#50 ~ #99) and try again.

■ **COPYING THE CURRENTLY SELECTED SONG** - You can copy the currently selected song to a User song location. While the song is stopped, first select a source song to copy from. Then, hold [MODE] and press [PAGE+] once or more to access the Song Copy function. The words “COPY SURE?” will appear in the LCD. Press [-1] and [+1] to select a destination User song number (#50 ~ #99) where the currently selected Preset or User song will be copied to. Then, press [ENTER] to copy the song. (To exit the Copy function, hold [MODE] and press [PAGE-].)



The initial tempo will also be copied to the destination User song.



If the LCD displays the words “MEMORY FULL”, you must free up memory by clearing any unwanted User patterns or songs. (Be sure to save any important User data first, offloading it to an external storage device such as the Yamaha MDF2 MIDI Data Filer.)

SONG RECORD MODE.

In Song Record Mode, you can select and record a User song in step-time or real-time, by designating Preset or User patterns (complete with backings) as one-measure song “parts”, and then recording chord changes at specific clock locations in the song.

There are two distinct “tracks” in a song—the pattern track (for the Preset and User patterns that make up the song) and the chord track (for the backing chord changes throughout the song). Each track is independent, and any changes you make in one track will not affect the other. For example, you can insert or delete a pattern without affecting the chord track. Likewise, you can insert or delete a chord without affecting the pattern track.

When constructing a song, you can take advantage of the RY8’s song Sections to create a professional sounding tune that flows naturally from part to part. For example, the Preset patterns are organized in 50 music styles with “Main A”, “Main B”, “Fill AB” and “Fill D” Sections for each style. The Main A and/or Main B Sections would be used for the verse and chorus parts of the song. The Fill AB Section would be used as a bridge to lead the Main A part naturally into the Main B part. The Fill BA Section would be used as a bridge to lead the Main B part naturally into the Main A part.



If the LCD displays the words “MEMORY FULL”, you cannot record a User song. To free up memory, clear any unwanted User patterns or songs. (Be sure to save any important User data first, offloading it to an external storage device such as the Yamaha MDF2 MIDI Data Filer.)

■ **ENTERING SONG RECORD MODE** - First, enter Song Mode and select a User song location. Then, press [REC] to enter Song Record Standby Mode, which means the RY8 will be standing by ready to record—by either the Step or Realtime recording process. (To exit Song Record Mode, press [REC] again.)

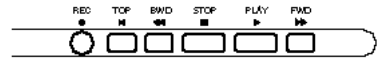
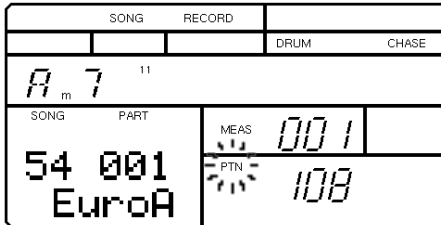

You cannot enter Song Record Mode when a Preset song (#00 ~ #49) is selected. If you press [REC] when a Preset song is selected, the word “PRESET” will appear briefly in the LCD to remind you to select a User song and then try again.

■ **ENTERING STEP RECORD MODE** - From within Song Record Standby Mode, you can go ahead and start entering data. (To exit Step Record Mode, press [REC] again.)

■ **RECORDING IN STEP-TIME** - Step recording is comprised of two distinct operations:

1. Entering one-measure song “parts” in the pattern track by selecting a Preset or User pattern number with [-1] and [+1].
2. Recording chord changes in the chord track with the Chord Assign feature.



In Step Record Mode, pressing [ENTER] after selecting a pattern number will advance the clock position location by one measure—ready for you to select the next part. This is especially useful when you want to enter the same pattern as a series of parts—just press [ENTER] several times.

■ **ENTERING REALTIME RECORD MODE** - From within Song Record Standby Mode, first, press [-1] or [+1] to select the pattern number that you want to be the first part in the song. Then, simply pressing [PLAY] will initiate the realtime recording operation. A count-in metronome click will begin (the number of count-in beats will appear on the screen, and will depend on the meter of the specified pattern), after which realtime recording will commence. (To exit Realtime Record Mode, press [STOP], then press [REC] again.)

■ **RECORDING IN REALTIME** - Realtime recording is also comprised of two distinct operations:

1. Selecting “Next” patterns with [-1] and [+1] which will record as one-measure song parts in the pattern track as the song plays—reaching the end when you press [STOP].
2. Recording chord changes in the chord track with the Chord Assign feature.



After recording the patterns that make up the song, the beat/clock position indicators (i.e., the inverted triangles in the upper right area of the LCD) will appear, which indicates that the song contains pattern data.



Pressing [PLAY] to engage realtime recording will erase any existing data.

■ **DELETING A PATTERN** - After recording a song, you can go back and delete a pattern at any time. First, in Song Record Mode, locate the measure of the pattern you want to delete, by pressing [FWD] and [BWD]. Next, hold [MODE] and press [PAGE+] once. The word “DEL” (Delete) will appear in the upper left area of the LCD, and the word “SURE?” will appear in the lower left area of the LCD. Then, press [ENTER] to delete the pattern. (All parts which succeed the deleted part will be brought forward by one part each, thus automatically filling the gap created by the deleted part.)

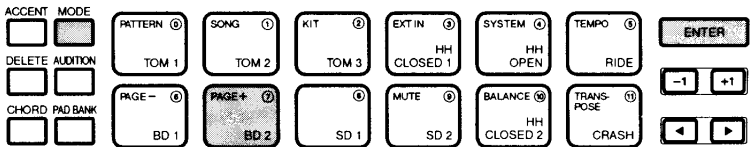
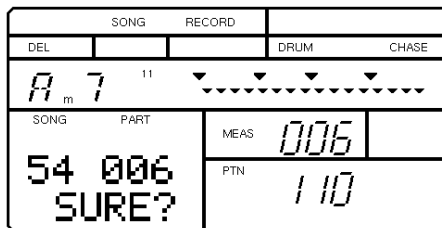



The pattern and chord tracks are independent! When deleting a pattern, the succeeding parts will be moved up by one part. Therefore, take care that your pattern deletions don't alter your song structure in relation to the chord track.

■ **INSERTING A PATTERN** - After recording a song, you can go back and insert a pattern at any time. First, in Song Record Mode, locate the measure of the pattern that you want to play after the inserted pattern, by pressing [FWD] and [BWD]. Next, hold [MODE] and press [PAGE+] twice. The word "INS" (Insert) will appear in the upper left area of the LCD, and the word "SURE?" will appear in the lower left area of the LCD. Next, select the new pattern by pressing [-1] and [+1]. Then, press [ENTER] to insert the selected pattern. (The inserted pattern will become a new song part, and all parts which succeed it will automatically be pushed back by one part each, thus lengthening the song by one part.)

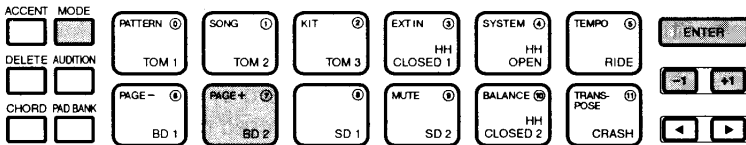
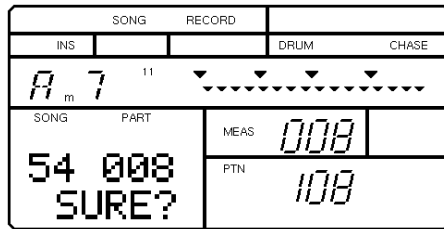

The pattern and chord tracks are independent! When inserting a pattern, the succeeding parts will be moved back by one part. Therefore, take care that your pattern insertions don't alter your song structure in relation to the chord track.

RECORDING CHORD CHANGES

To record chord changes in the chord track at specific clock locations in the song, first you must access the Chord Assign feature.

■ **ACCESSING CHORD ASSIGN** - From within Step Record Mode, press [CHORD]. The words “BEAT” and “CLOCK”—which display the current beat and clock location of the currently selected measure—will appear in the lower left area of the LCD, and a small inverted triangle will appear over the Chord Root in the upper left area of the LCD. (You can press [◀] and [▶] to position the flashing cursor over the Chord Root, Chord Type or beat/clock position.)

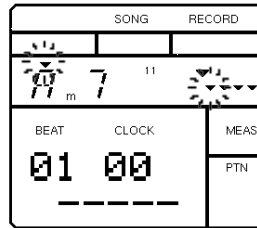

■ **SPECIFYING A CLOCK** - After pressing [CHORD], press [BWD] and [FWD] to select a measure. If you want to enter the chord change at a clock position other than at the top of each measure, press [-1] and [+1] to specify a particular clock in the measure. You can select the precise clock position in a measure to change the chord by pressing [▶] twice to position the flashing cursor over the beat/clock.

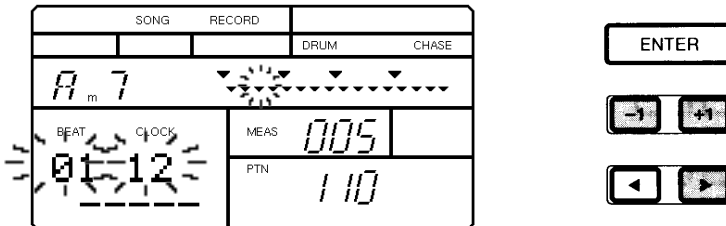

■ **DESIGNATING A CHORD ROOT AND TYPE** - After selecting the measure and specifying the clock, press [◀] twice to position the flashing cursor over the Chord Root, and press [-1] and [+1] to select the Chord Root. Next, press [▶] once to position the flashing cursor over the Chord Type, and press [-1] and [+1] to select the Chord Type. Then press [ENTER]. Recorded chord data will be displayed as a black square at the specified location.

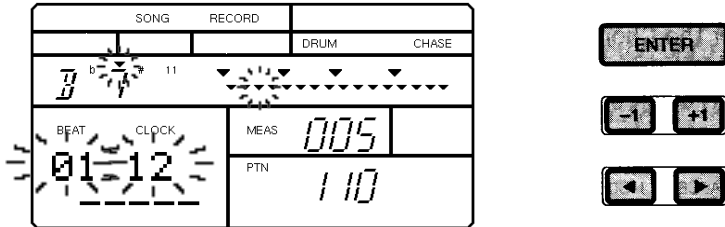



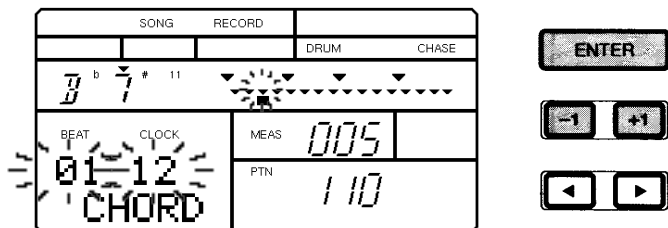
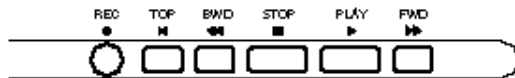





















■ **DELETING A CHORD BY EVENT** - Even after recording a song, you can go back and delete an unwanted chord at any time at a specific event location, or clock position. First, in Song Record Mode, press [CHORD] to access Chord Assign. Next, locate the measure containing the chord you want to delete, by pressing [FWD] and [BWD]. Then, move the cursor to the beat/clock position and press [+1] or [-1] to locate a specific beat/clock position. (A small black square will display beneath a clock position where chord change data exists.) Finally, hold [DELETE] and press [ENTER] to delete the chord data.

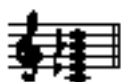

CHORD TYPES (Key of C)

LCD DISPLAY

DEFINITION

<p>(Blank) Major</p> 	<p>m Minor</p> 	<p>7 Dominant</p> 	<p>m7 Minor dominant</p> 	<p>M7 Major dominant</p> 
<p>mM7 Minor Major dominant</p> 	<p>sus4 Suspended Fourth</p> 	<p>7sus4 Dominant Suspended Fourth</p> 	<p>m7 b5 Minor dominant Flatted Fifth</p> 	<p>dim Diminished</p> 
<p>6 Sixth</p> 	<p>m6 Minor sixth</p> 	<p>#5 Augmented</p> 	<p>7#5 Dominant Augmented</p> 	<p>add9 Added Ninth</p> 
<p>m add9 Minor Added Ninth</p> 	<p>7 9 Dominant Ninth</p> 	<p>7 b9 Dominant Flatted Ninth</p> 	<p>7#9 Dominant Sharp Ninth</p> 	<p>M7 9 Major dominant Ninth</p> 
<p>m7 9 Minor dominant Ninth</p> 	<p>7#11 Dominant Sharp Eleventh</p> 	<p>m7 11 Minor dominant Eleventh</p> 	<p>7 13 Dominant Thirteenth</p> 	

■ **DELETING A CHORD BY PART** - After recording a song, you can go back and delete an unwanted chord at any time at a specific part, or measure location. First, in Song Record Mode, press [CHORD] to access Chord Assign. Next, locate the measure containing the chord you want to delete, by pressing [FWD] and [BWD]. Then, hold [MODE] and press [PAGE+] once. The abbreviation “DEL” (Delete) will appear in the upper left area of the LCD, and the word “SURE?” will appear in the lower left area of the LCD. Finally, press [ENTER] to delete the chord data.



The pattern and chord tracks are independent! When deleting a chord by part, the succeeding parts will be moved up by one part. Therefore, take care that your chord deletions don't alter your song structure in relation to the pattern track.

■ **INSERTING A CHORD** - After recording a song, you can go back and insert a chord at any time. First, in Song Record Mode, press [CHORD] to access Chord Assign. Next, locate the measure in which you want to insert the new chord, by pressing [FWD] and [BWD]. Then, hold [MODE] and press [PAGE+] twice. The abbreviation “INS” (Insert) will appear in the upper left area of the LCD, and the word “SURE?” will appear in the lower left area of the LCD. Finally, press [ENTER] to insert the chord data.

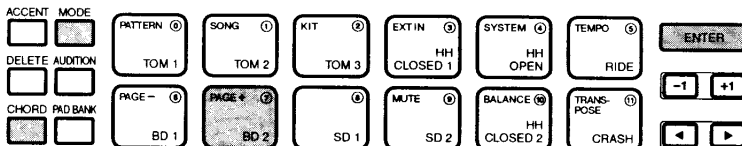
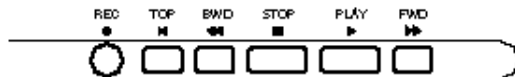
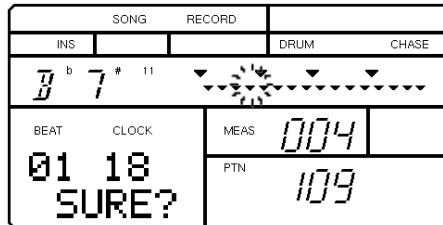



The pattern and chord tracks are independent! You can only insert a chord by part, and not event. When inserting a chord, the succeeding parts will be moved back by one part. Therefore, take care that your chord insertions don't alter your song structure in relation to the pattern track.

■ **EXITING CHORD ASSIGN** - To exit the Chord Assign feature, press [CHORD] again.



If you attempt to enter a chord change and the message "PART EMPTY" appears in the LCD, this means that there is no pattern data in the track.

■ **CHANGING A PATTERN** - After recording a song, you can go back and change a pattern at any time. First, in Song Record Mode, locate the measure of the pattern you want to change, by pressing [FWD] and [BWD]. Next, select the new pattern by pressing [-1] and [+1].

■ **CHANGING A BACKING** - As you record song parts by selecting and entering patterns, the backings which are assigned to the various patterns will also be recorded in the song. Although you cannot change a backing in Song Record Mode, there is in fact an easy way to change the backing. First, enter Pattern Mode and access the pattern Copy function and copy the pattern to a User pattern location. Next, assign the different backing to it (see "ASSIGNING A BACKING TO A USER PATTERN", page 34). Then, return to Song Record Mode and follow the procedure outlined above in "CHANGING A PATTERN".

■ **EXCEEDING THE MAXIMUM NOTE POLYPHONY** - The RY8 has 28-note polyphony, which means the maximum number of notes that can sound at one time is 28. Depending on the song you have created, several drum beats may fall on a specific location where many bass and chord notes exist. Any drum beats that would exceed the 28-note capacity will be "truncated", or cut off, or will not play.



Turning the power off while Song Record Mode is active, or while the song Copy or Clear function is being executed, may cause the irretrievable loss of all User data.



12. DRUM KIT MODE

In Drum Kit Mode you can select a Preset or User drum kit, assign voices to the pads in a User kit, and designate various settings for the pads in a User kit, including specifying output and accent levels and setting the stereo pan positioning and pitch tuning for each drum pad. You can also copy a Preset or User drum kit to a User drum kit, and activate the Chase feature.

■ **ENTERING DRUM KIT MODE** - Hold [MODE] and press [KIT] to enter Drum Kit Mode.

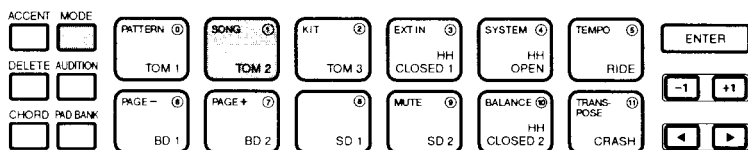

■ **SELECTING A FUNCTION** - Hold [MODE] and press [PAGE+] and [PAGE-] to step through the various functions. The LCD will display information about the status of each function as you step through them.

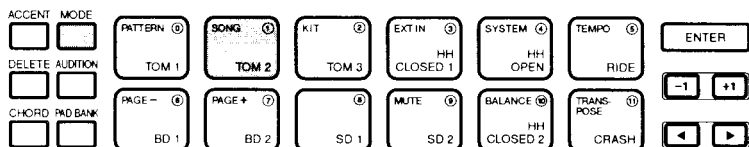

PLAYING THE PADS AND SELECTING KITS.

You can generally play the drum pads in real-time regardless of the mode you're in. From within some of the Drum Kit Mode functions, pressing the pad buttons will also display information about the various settings for each pad.

■ **SELECTING THE PAD BANKS** - Each of the twelve drum pads has two drum voices assigned to it. These are organized in "Drum" and "Percussion" Pad Banks. To switch back and forth between the two Pad Banks, press [PAD BANK]. Either the word "DRUM" (Drum Pad Bank) or the abbreviation "PERC" (Percussion Pad Bank) will appear in the upper right area of the LCD as you switch back and forth between each bank.

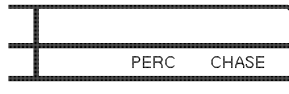
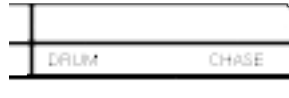
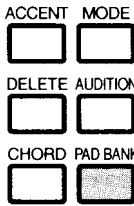

■ **ADDING ACCENTS AS YOU PLAY** - Each drum voice in a kit has a designated "accent level" assigned to it which permits you to apply playing dynamics to the drum beats as you play in real-time, as well as record accents in User patterns. To add accents while playing the various drum pads, hold [ACCENT] to apply the accent level to the desired drum hits. The accent level for each drum voice in the Preset drum kits cannot be modified; however, you can specify the accent level (for softer or louder dynamics) for each drum voice in a User drum kit.

■ **SELECTING THE DRUM KITS** - The currently selected drum kit will depend on which pattern is chosen, since each Preset pattern uses a specific drum kit. There are 16 drum kits in all—12 Preset kits (#00 ~ #11) and 4 User drum kits (#12 ~ #15). When you enter Drum Kit Mode, the word “SELECT”, along with the name of the currently selected drum kit, displays in the lower left area of the LCD. The flashing cursor will be positioned over the word “KIT”, and next to it the number of the currently selected drum kit (00 ~ 15) will be displayed. To select a different drum kit, press [-1] and [+1].

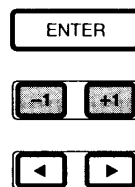

When shipped, the Preset drum kits #00 ~ #03 are assigned to User drum kits #12 ~ #15, respectively. For a listing of the 16 drum kits and their respective drum pad voice assignments, see page 84. For a listing of the 128 drum voices, see page 82.

■ **COPYING THE CURRENTLY SELECTED DRUM KIT** - You can make modifications to User drum kits only, so if you want to change a Preset drum kit, you must first copy it to a User drum kit location. To do so, first, select the Preset drum kit you want to copy. Then, hold [MODE] and press [PAGE+] several times to access the Kit Copy function. The words “COPY SURE?” will appear in the lower left area of the LCD. Press [-1] and [+1] to select the destination User kit (#12 ~ #15). Then, press [ENTER] to copy the currently selected kit to the designated User drum kit location.

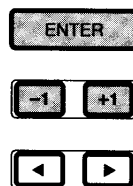
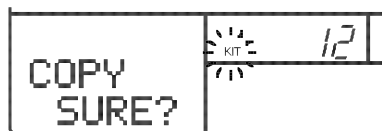

CREATING A USER DRUM KIT.

One of the keys to the RY8's flexibility is that you can create up to four of your own User drum kits by assigning any of the 128 AWM drum voices to the 12 Drum Pad Bank pads and 12 Percussion Pad Bank pads, as well as specify output level, accent level, pan position and pitch tuning for each drum voice.

When creating your own User drum kit, you can start by either copying an existing Preset kit to a User kit location, or selecting a User kit memory and begin assigning voices to the pads and designating other Kit Mode function settings at will.

As you create a User drum kit and make modifications to the various function settings, the assignments and settings you make will only affect the pads, and not the drum voices themselves. For example, if you set a stereo pan position for a particular drum sound, the setting is only designated for the currently selected drum pad—i.e., you can still assign a different voice to the pad and the pan position will remain the same.



If the word "PRESET" temporarily appears on the LCD when you try to modify a Drum Kit function setting, this means you are attempting to modify a Preset drum kit. If this happens, simply select a User drum kit (#12 ~ #15), or copy the currently selected Preset drum kit to a User drum kit, and try again.

■ **ASSIGNING DRUM VOICES TO THE PADS** - You can assign any of the 128 AWM drum voices to the pads in a User drum kit. Hold [MODE] and press [PAGE+] or [PAGE-] to access the voice Assign function. The word "ASSIGN" will display in the lower left area of the LCD, and the name of the drum voice which is assigned to the currently selected pad will be flashing. Press any drum pad (within either the Drum or Percussion Pad Bank)— the name of the drum voice assigned to the pad you select will appear in the LCD. Press [-1] and [+1] to select one of the 128 drum voices and assign it to the pad. (As you step through each drum voice, you can hit the pad in order to hear how the voice sounds.) After you've assigned a drum voice to the first pad, simply select a different pad and repeat the procedure until you have created your own User drum kit.

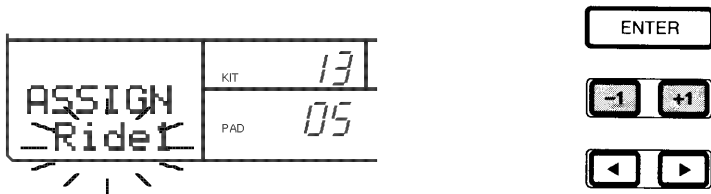

PAD NUMBERS

Each of the 24 pads in the Drum and Percussion Pad Banks has a specific pad number assigned to it, between 0 ~ 23, as shown below.

DRUM PAD BANK = Pad numbers 0 ~ 11

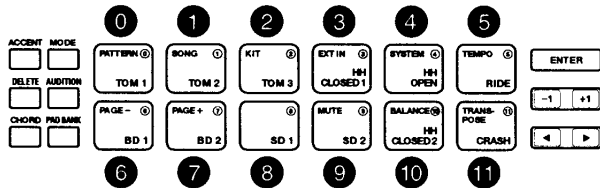

PERCUSSION PAD BANK = Pad numbers 12 ~ 23

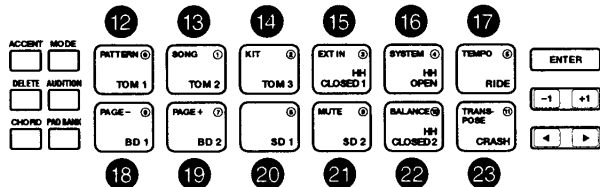

■ SETTING THE OUTPUT LEVELS - You can designate the output level for each pad in a User drum kit. Hold [MODE] and press [PAGE+] or [PAGE-] to access the output Level function. The word "LEVEL" will appear in the lower left area of the LCD, and the level setting of the currently selected pad will be flashing. Press any drum pad (within either the Drum or Percussion Pad Bank) to select it. Press [-1] and [+1] to change the level setting from between "01" and "16". (As you change the level value, you can hit the pad in order to hear the effect of the level change.) After you've set the level for the first pad, simply select a different pad and repeat the procedure until you have set the levels for all voices in your User drum kit.

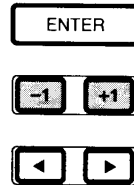
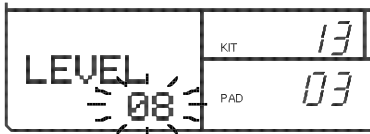

■ SETTING THE ACCENT LEVELS - You can designate the accent level for each pad in a User drum kit. Hold [MODE] and press [PAGE+] or [PAGE-] to access the Accent level function. The word "ACCENT" will appear in the lower left area of the LCD, and the level setting of the currently selected pad will be flashing. Press any drum pad (within either the Drum or Percussion Pad Bank) to select it. Press [-1] and [+1] to change the accent level setting from between "-7" and "+7". (As you change the accent level value, you can hold [ACCENT] and hit the pad in order to hear the effect of the accent level change.) After you've set the accent level for the first pad, simply select a different pad and repeat the procedure until you have set the accent levels for all voices in your User drum kit.

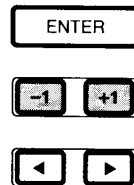
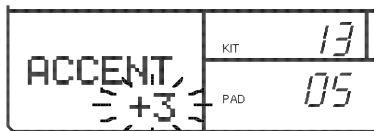

The output volume of each pad will depend on its output Level setting, plus the Accent level value when an accent is applied.

■ SETTING THE STEREO PAN POSITIONS - You can designate the stereo pan position for each pad in a User drum kit. Hold [MODE] and press [PAGE+] or [PAGE-] to access the Pan function. The word "PAN" will appear in the lower left area of the LCD, and the pan setting of the currently selected pad will be flashing. Press any drum pad (within either the Drum or Percussion Pad Bank) to select it. Press [-1] and [+1] to change the pan setting from between "-7" and "+7", or "OFF". If you select "OFF", then the default pan position for the drum voice will be designated. (As you change the pan settings, you can hit the pad in order to hear the effect of the pan change.) After you've set the pan position for the first pad, simply select a different pad and repeat the procedure until you have set the pan positions for all voices in your User drum kit.

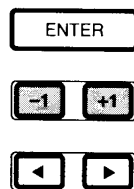
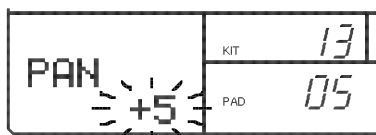

■ TUNING THE PITCH OF THE DRUMS - You can designate the pitch tune setting for each pad in a User drum kit. Hold [MODE] and press [PAGE+] or [PAGE-] to access the Tune function. The word "TUNE" will appear in the lower left area of the LCD, and the tune setting of the currently selected pad will be flashing. Press any drum pad (within either the Drum or Percussion Pad Bank) to select it. Press [-1] and [+1] to change the pitch tune setting from between "-7" and "+7", where "0" represents the normal pitch of the drum sound. (As you change the tune settings, hit the pad in order to hear the effect of the pitch change.) After you've set the pitch tuning for the first pad, simply select a different pad and repeat the procedure until you have set the tuning for all voices in your User drum kit.

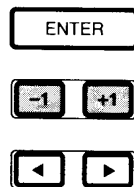
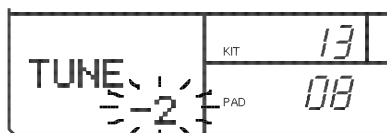

■ TURNING THE CHASE FUNCTION ON AND OFF - The Chase function determines which drum kit will play a pattern. When the Chase function is on, the drum kit used to record the pattern will automatically be selected for the pattern playback. When the Chase function is off, the currently selected drum kit will be used for playback of all patterns. The Chase setting, which is set to "ON" when the RY8 is shipped, affects the entire system. Hold [MODE] and press [PAGE+] once or more to access the Chase function. The word "CHASE" will appear in the lower left area of the LCD. Press [+1] to turn the Chase function on. When Chase is turned on, the word "CHASE" will appear in the upper right area of the LCD. Press [-1] to turn the Chase function off.

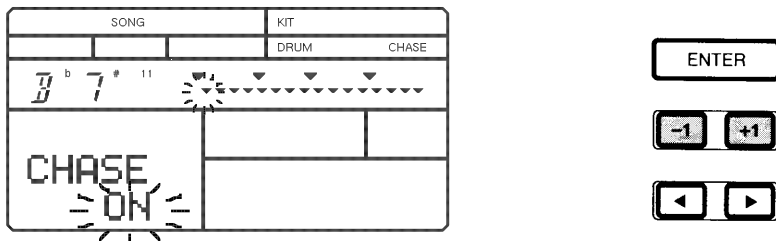

13. EXTERNAL IN MODE

The RY8 features a special [EXT IN] input jack that lets you connect a guitar directly to the RY8 and play along with the patterns and songs, use the RY8 as a guitar tuner, or use the RY8 as a guitar synthesizer by "triggering" any of the 50 AWM normal voices (including acoustic piano, strings, brass, synth pad sounds, etc.), and more. (For details about connecting a guitar, see page 16.) So the amount of music that can come from the RY8 at one time is the drums, bass and two chord parts from the patterns/songs, plus a guitar signal and the synthesized External In voice.

In External In Mode you can turn the Mix function on and off, specify the External In voice and guitar synthesizer status, activate the guitar tuner, assign the trigger sensitivity level for the External In voice, and turn the remote Start function on and off.

■ **ENTERING EXTERNAL IN MODE** - Hold [MODE] and press [EXT IN] to enter External In Mode.

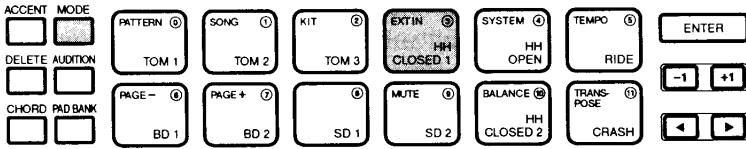

■ **SELECTING A FUNCTION** - Hold [MODE] and press [PAGE+] and [PAGE-] to step through the various functions. The LCD will display information about the status of each function as you step through them.

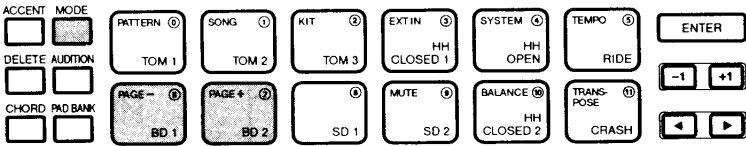

■ **TURNING THE MIX FUNCTION ON AND OFF** - When the Mix function is turned on, the guitar signal you play will be mixed with the patterns/songs, and both will be output via the stereo [OUTPUT] jacks and [PHONES] jack. Hold [MODE] and press [PAGE-] once or more, if necessary, to access the Mix function. The word "MIX" will appear in the lower left area of the LCD, along with the current Mix function status— "ON" or "OFF". Press [+1] to turn the Mix function on. Press [-1] to turn the Mix function off.



To determine the volume level of the guitar, adjust the guitar's volume knob.

■ **USING THE RY8 AS A GUITAR SYNTHESIZER** - When a guitar (not an Electric Bass) is plugged into the [EXT IN] jack, you can use the guitar to trigger an External In voice in a variety of ways. There are two steps to setting up the RY8 as a guitar synthesizer:

1. Designating the guitar synthesizer status.
2. Selecting an external in voice (see below).

1. DESIGNATING THE EXTERNAL IN GUITAR SYNTHESIZER STATUS -

The status of the guitar synthesizer determines how the External In voice triggered by the notes you play on the guitar will sound—e.g., you can turn the External In voice off, or synthesize the guitar signal with a single voice, or octaves, harmonies or a chord. Hold [MODE] and press [PAGE+] or [PAGE-] to access the External In Select function. Then, press [-1] and [+1] to designate the synthesizer status, as explained below.

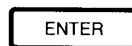

- OFF** - The External In voice will not play.
- SINGLE** - A single note of the External In voice will play in the same pitch as the notes you play on the guitar.
- OCTAVE** - Two notes of the External In voice will play—one note in the same pitch as the notes you play on the guitar, plus one note an octave lower.
- HARM 1, 2, 3** - Two notes of the External In voice will play—one in the same pitch as the notes you play on the guitar, plus a harmony, matched to the current chord as displayed in the upper left area of the LCD.
- CHORD** - Any note you play on the guitar will trigger the current chord as displayed in the upper left area of the LCD.

2. SELECTING AN EXTERNAL IN VOICE - You can select any of the 50

AWM normal voices to be triggered by the notes you play on the guitar. Hold [MODE] and press [PAGE+] or [PAGE-] to access the External In Select function. Two lines of information will be displayed in the lower left area of the LCD. The current synthesizer status (see above) will be displayed in the top line, and the name of the currently selected External In voice will be displayed in the bottom line. Press [▶] once to position the flashing cursor over the voice name, then press [-1] and [+1] to select a different voice.

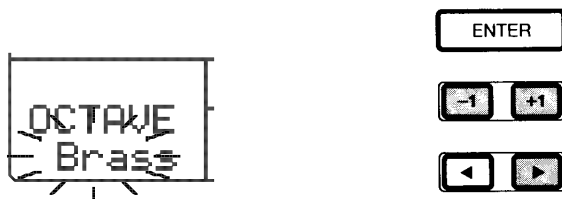

For a list of the AWM normal voices, see page 89.



The RY8 can only recognize single notes that you play on the guitar; i.e., it cannot recognize block chords. Recognizing the specific notes you play on the guitar and in turn triggering a voice to play in the same pitch is a rather sophisticated technological feat. The quality of the results you get will depend on a combination of factors, including the type of guitar you use, guitar volume level, tone and pickup settings, and the External In Mode Sensitivity function setting (see below). Achieving a satisfactory result may require some experimentation with playing style and the various settings. Your playing style may also cause a different pitch than the one you desired, or note truncation.

■ **SETTING THE EXTERNAL IN SENSITIVITY LEVEL** - You can specify the sensitivity setting for the External In voice to be triggered by the guitar signal. Hold [MODE] and press [PAGE+] or [PAGE-] to access the Sensitivity function. The abbreviation "SENS" (Sensitivity) will appear in the lower left area of the LCD, along with the current sensitivity setting. Press [-1] and [+1] to specify the Sensitivity function setting between "00" and "19", where lower values represent less sensitivity, and higher values represent more sensitivity.

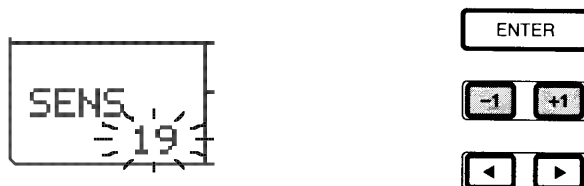

The RY8 cannot record the External In part as played by the guitar signal.

■ **TURNING THE EXTERNAL IN START FUNCTION ON AND OFF** - When the External In Start function is turned on, the pattern or song playback will begin automatically with the first note you play on the guitar. Hold [MODE] and press [PAGE+] once or more to access the Start function. The word “START” will appear in the lower left area of the LCD, along with the current Start function status—“ON” or “OFF”. Press [+1] to turn the Start function on. Press [-1] to turn it off. (To stop the playback, press [STOP].)

Press



USING THE RY8 AS A GUITAR TUNER

The RY8 has a built-in guitar tuner which is extremely easy to use. Simply plug a guitar into the [EXT IN] jack, turn up the volume, access the External In Mode Tuner function, and play a string. The RY8 will sense the pitch of the string you play, and will display the pitch in the upper left area of the screen. It will also sense if the pitch is sharp or flat, and will indicate this by small black squares that appear on a horizontal “scale” in the upper right area of the screen.

■ **USING THE GUITAR TUNER** - Hold [MODE] and press [PAGE+] or [PAGE-] to access the Tuner function. Then, play an open string on the guitar and begin tuning the string.

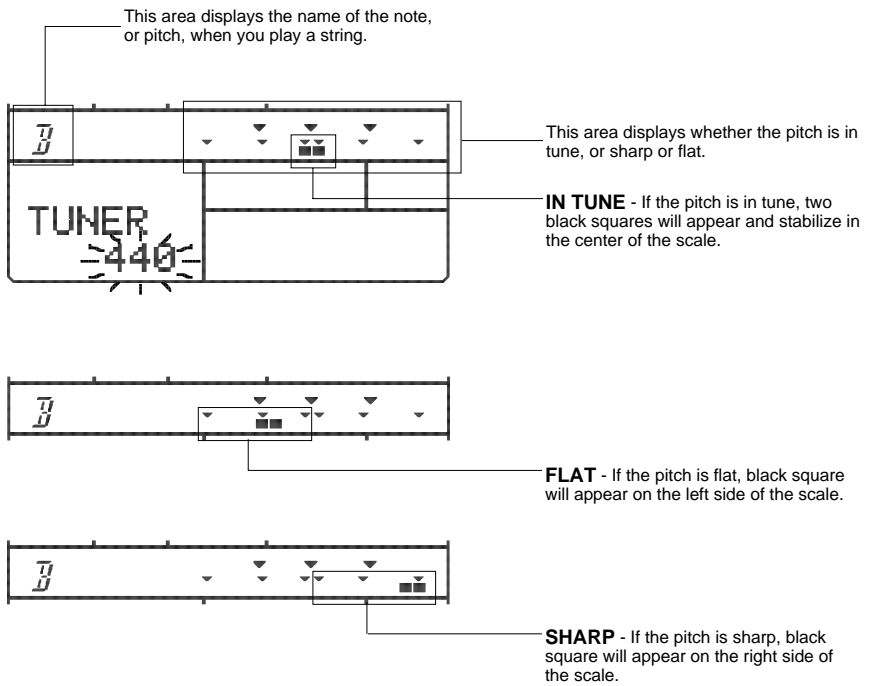

■ **SETTING THE BASIC PITCH** - You can set the basic pitch of the guitar tuner between “440” and “445”. From within the Tuner function, press [+1] and [-1] to set the basic pitch.

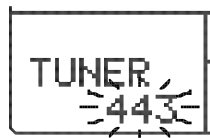

The basic pitch setting determines the overall system tuning for the RY8.

14. SYSTEM MODE

In System Mode you can designate Internal or MIDI sync clock, assign the MIDI transmit and receive channel for the drum voices, assign the MIDI channel for receiving program change messages, assign the MIDI transmit channel for the External In voice and the Harmony voice, activate bulk dump operations, and designate the note table and assign the note numbers for the drum kit.

■ **ENTERING SYSTEM MODE** - Hold [MODE] and press [SYSTEM] to enter System Mode.

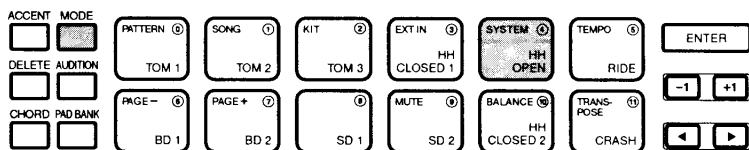

■ **SELECTING A FUNCTION** - Hold [MODE] and press [PAGE+] and [PAGE-] to step through the various functions. The LCD will display information about the status of each function as you step through them.

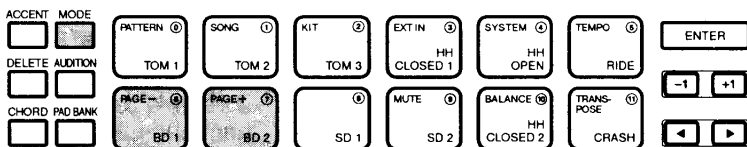

■ **DESIGNATING THE SYNC CLOCK** - You can connect an external sequencer to the RY8 and synchronize, or “sync” the two devices together so that their clocks will play in perfect time with each other. The RY8 may be designated as the “master” device, which means you should set its sync clock to Internal, and the external sequencer’s clock to MIDI. Or the RY8 may be designated as the “slave” device, which means you should set its sync clock to MIDI, and set the external sequencer’s clock to Internal. Hold [MODE] and press [PAGE-] once or more, if necessary, to access the Sync function. The word “SYNC” will appear in the lower area of the LCD, along with the current sync clock status—“INT” (Internal) or “MIDI”. Press [-1] to set the sync clock to “INT” status. Press [+1] to set the sync clock to MIDI status.



■ **ASSIGNING THE MIDI TRANSMIT/RECEIVE CHANNEL** - You can connect a MIDI keyboard and play the RY8’s drum voices from its keyboard. Likewise, you can play the RY8’s drum voices from an external sequencer. To do so, you must assign the RY8’s MIDI channel to the same channel number as the external device. Hold [MODE] and press [PAGE-] or [PAGE+] to access the MIDI Channel function. The abbreviation “CH” (Channel) will appear in the lower left area of the LCD, along with the current channel assignment (“01 ~ 16”, “OFF”). Press [-1] and [+1] to assign the RY8’s MIDI channel number.

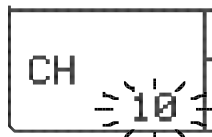

■ **ASSIGNING THE PROGRAM CHANGE RECEIVE CHANNEL** - You can have the

RY8 respond to program change messages from an external MIDI keyboard or sequencer. For example, by pressing the voice selectors on your keyboard, you can select the RY8's drum kits. To do so, you must assign the RY8's program change receive channel to the same program change channel number as the transmitting device. Hold [MODE] and press [PAGE-] or [PAGE+] to access the Program Change function. The abbreviation "PC" (Program Change) will appear in the lower left area of the LCD, along with the current channel assignment ("01 ~ 16", "OFF"). Press [-1] and [+1] to assign the RY8's MIDI Program Change receive channel number.

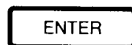
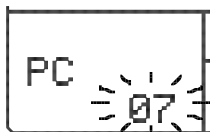

Refer to the Drum Kit List on page 84 for the program change numbers exclusive to each drum kit.



■ **ASSIGNING THE EXTERNAL IN VOICE TRANSMIT CHANNEL** - The RY8 can

transmit MIDI signals generated by the External In voice (as played from the guitar) in order to play an external tone generator. To do so, you must assign the RY8's External In voice channel to the same MIDI receive channel number as the tone generator. Hold [MODE] and press [PAGE-] or [PAGE+] to access the External In Channel function. The abbreviation "EXT CH" (External In Channel) will appear in the lower left area of the LCD, along with the current channel assignment ("01 ~ 16", "OFF"). Press [-1] and [+1] to assign the RY8's External In voice channel number.

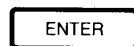

■ **ASSIGNING THE HARMONY VOICE TRANSMIT CHANNEL** - The RY8 can transmit MIDI signals generated by the Harmony voice (see “HARM 1, 2, 3”, page 63) in order to play an external tone generator. To do so, you must assign the RY8’s Harmony voice channel to the same MIDI receive channel number as the tone generator. Hold [MODE] and press [PAGE+] once or more to access the Harmony Channel function. The abbreviation “HRM CH” (Harmony Channel) will appear in the lower left area of the LCD, along with the current channel assignment (“01 ~ 16”, “OFF”). Press [-1] and [+1] to assign the RY8’s Harmony voice channel number.

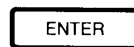
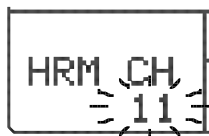

Some MIDI keyboards and synthesizers have built-in sequencers, as well as floppy disk drives which can send and receive bulk data, program change messages, etc. Consult the owner’s manual of your keyboard or synthesizer to determine the extent of its MIDI capabilities.



The pitch bend range for the External In voice and Harmony voice is 12 (± one octave). Assign the same setting for the pitch bend range of the external device.



MIDI DATA BULK DUMP OPERATIONS

You can “dump” User pattern, song and drum kit data in bulk to and from another RY8 or an external MIDI data storage device (such as the Yamaha MDF2 MIDI Data Filer).

■ **BULK DUMP TRANSMIT** - First, set up the storage device to receive a bulk dump transmission (refer to the owner’s manual of the storage device for the proper procedure). Hold [MODE] and press [PAGE+] or [PAGE-] to access the Bulk Dump function. The words “BULK SURE?” will appear in the lower left area of the LCD. Press [ENTER] to initiate the bulk dump transmission operation. When the operation is finished, the word “END” will appear briefly on the LCD.



■ **BULK DUMP RECEIVE** - As long as the RY8 is in the Select function of Song Play Mode or Pattern Play Mode, and the song or pattern is not playing, it can automatically receive a bulk dump initiated from an external storage device. (Refer to the owner’s manual of the storage device for the proper procedure for initiating a bulk dump transmit operation.)

■ **DESIGNATING THE PRESET OR USER NOTE TABLE** - The MIDI note table consists of a list of the drum pads and a corresponding MIDI note number for each pad. When playing the RY8's drum voices from an external keyboard or sequencer, the drum voices will play according to the RY8's note table assignments. The RY8 has both a Preset note table, which you cannot modify, and a User note table, which you can modify using the Note Number function (see below). To designate the Preset or User note table, hold [MODE] and press [PAGE+] or [PAGE-] to access the Note Table function. The abbreviation "NT TBL" (Note Table) will appear in the lower left area of the LCD, along with the current Note Table status—"PRE" (Preset) or "USER". Press [-1] to designate the Preset note table. Press [+1] to designate the User note table.

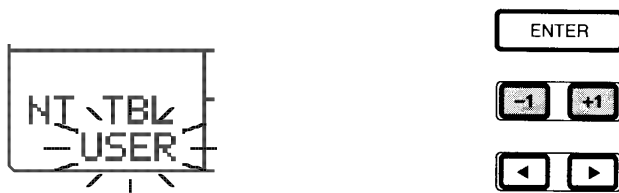

■ **ASSIGNING THE NOTE NUMBERS TO THE PADS** - When the Note Table function is set to USER (see above), you can freely assign note numbers to the pads. Hold [MODE] and press [PAGE-] or [PAGE+] to access the Note Number function. The abbreviation "NT" (Note) will appear in the lower left area of the LCD, and just to the right of it, the note number of the currently selected pad will be flashing. The name of the drum voice currently assigned to the drum pad (based on the selected drum kit) will also be displayed. Press any drum pad (within either the Drum or Percussion Pad Bank) to select it. Then, press [-1] and [+1] to assign the new note number to the pad, between "000" and "127", and "OFF". After you've set the note number for the first pad, simply select a different pad and repeat the procedure until you have set the note numbers for all pads.

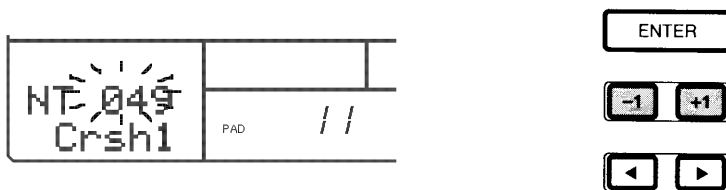

If the word "PRESET" temporarily appears on the LCD when you try to change a note number, this means you are attempting to modify the Preset note table. If this happens, access the Note Table function (see above) and set it to "USER" status.

15. TEMPO MODE

In Tempo Mode you can set the tempo for the song or pattern playback or recording. You can switch into Tempo Mode and change the playback tempo as the pattern or song is playing.

Each Preset pattern and song has an “initial tempo” assigned to it. Whenever you select a Preset pattern and press [PLAY], the initial tempo will be activated.

■ **ENTERING TEMPO MODE** - Hold [MODE] and press [TEMPO] to enter Tempo Mode. The word “TEMPO” will appear in the lower left area of the LCD, along with the current tempo value.

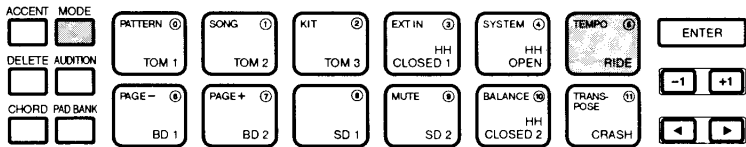

■ **CHANGING THE TEMPO** - Press [-1] and [+1] to set the tempo between 40 and 250 beats per minute.



Any changes you make to the initial tempo of a Preset pattern or song will be temporary, but the tempo change made to a User pattern or song will be retained.



When the sync clock is set to “MIDI”, dashes (“--”) will display in the LCD and you will not be able to change the tempo. (For information about the sync clock, see page 68.)

16. MUTE MODE

In Mute Mode you can mute (i.e., switch off) any or all of the backing accompaniments, even while the song or pattern is playing.

■ **ENTERING MUTE MODE** - Hold [MODE] and press [MUTE] to enter Mute Mode. The word “MUTE” will appear in the lower left area of the LCD, along with the currently selected backing track and its present status—“ON” or “OFF”.

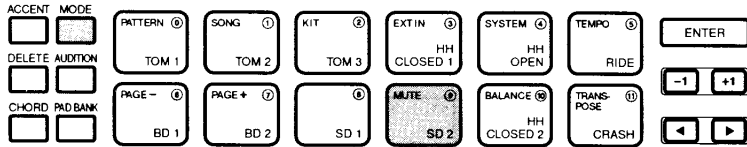

■ **SELECTING A BACKING TRACK** - Hold [MODE] and press [PAGE+] and [PAGE-] to select the Bass Track Mute (“B”), Chord 1 Track Mute (“C1”), or Chord 2 Track Mute (“C2”) function. The LCD will display the mute on/off status of each as you step through them.

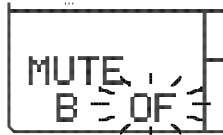

■ **MUTING THE BACKING TRACK** - Select either the Bass, Chord 1 or Chord 2 track and press [+1] to turn the Mute on for the selected backing track. The word “ON” will appear in the LCD. Press [-1] to turn the Mute off for the selected backing track. The abbreviation “OF” (Off) will appear in the LCD.

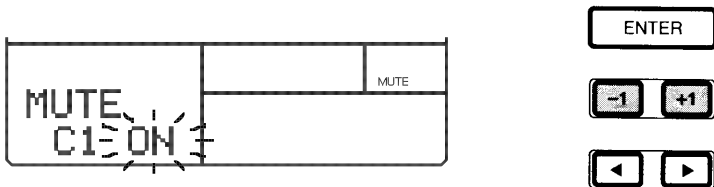

Whenever any or all backing tracks are muted, the word “MUTE” will appear in the middle right area of the LCD.

17. BALANCE MODE

Balance Mode is in effect an on-board “sound mixer” that lets you balance the relative levels of the normal voices. In Balance Mode you can balance the volume output levels for the Bass, Chord 1, and Chord 2 backing voices, as well as the output of the External In and Harmony voices, even while the pattern or song is playing.

■ **ENTERING BALANCE MODE** - Hold [MODE] and press [BALANCE] to enter Balance Mode. The abbreviation “BALANC” (Balance) will appear in the lower left area of the LCD, along with the currently selected normal voice and its present value—between “-7” and “+7”.

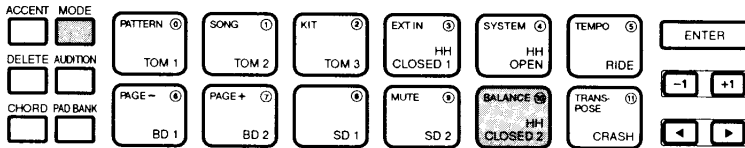

■ **SELECTING A VOICE** - Hold [MODE] and press [PAGE+] and [PAGE-] to select the Bass (“B”), Chord 1 (“C1”), Chord 2 (“C2”), External In (“EXT”) or Harmony (“HRM”) voice Balance function. The LCD will display the balance levels of each as you step through them.

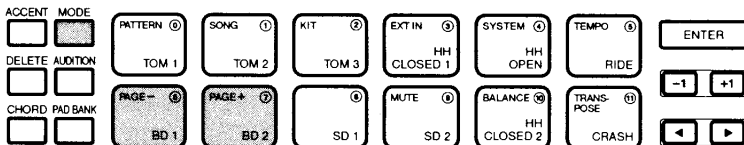

- **SETTING A BALANCE LEVEL** - Select either the Bass, Chord 1, Chord 2, External In or Harmony voice and press [-1] and [+1] to set the balance level for the selected voice.



The volume level of the guitar itself can only be determined by the setting of the guitar's volume knob.

18. TRANSPOSE MODE

In Transpose Mode you can specify the transposition pitch in half-steps for a song or pattern, even during playback.

- **ENTERING TRANSPOSE MODE** - Hold [MODE] and press [TRANSPOSE] to enter Transpose Mode. The abbreviation "TRANS" will appear in the lower left area of the LCD, along with the current transposition value.

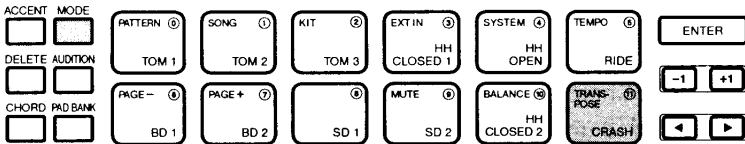

- **CHANGING THE TRANSPOSE VALUE** - Press [-1] and [+1] to change the transposition value in half-steps between "-12" and "+12" (within ± one octave), with "0" representing normal pitch.

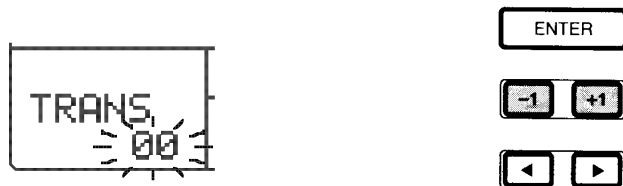

APPENDIX

19. RECALLING THE FACTORY DEFAULT SETTINGS

You can reset all RY8 settings to their initial default settings at any time. Doing so will clear all the User patterns, songs and drum kits you have created.



Before initiating the factory default setting operation, be sure to save any important User data using an external MIDI data storage device (such as the Yamaha MDF2 MIDI Data Filer).

■ **RECALLING THE FACTORY DEFAULT SETTINGS** - First, switch the [POWER] to the [OFF] position. Next, hold both [-1] and [+1] buttons down simultaneously, then switch the [POWER] back to [ON].

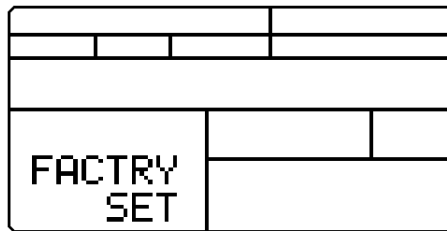

The words “FACTRY SET” will momentarily appear on the LCD screen, the RY8 will be in Pattern Select Mode.

20. DISPLAY MESSAGES

During operation the RY8 will display various error and other messages in the LCD. Below is a list and description of each display message.

DISPLAY	COMMENTS
BACKUP ERROR	If the batteries are dead (or are not installed), when you turn the RY8 on, this message will appear, the factory default settings will be reinstated, and the User data will have been lost.
BATT LOW	The batteries are running low on power. Insert a new set of six batteries. (Do not mix and match old and new batteries or batteries of a different type, such as alkaline and manganese!)
BUFFER FULL	MIDI receive buffer memory is too full to receive any more data. Reduce the amount of data being sent to the RY8.
BULK SEND	Bulk data is being transmitted to a MIDI data storage device or another RY8.
DATA ERROR	An error occurred during the bulk data receive operation due to unrecognizable MIDI data. Make sure that all bulk data sent to the RY8 conforms with the RY8 MIDI specification.
END	The current operation is completed.
MEMORY FULL	Memory is too full to hold any more data, and the specified operation cannot be performed. Delete unwanted songs or patterns to make more memory available.
MIDI ERR 1	A MIDI overrun error was detected in the incoming data during MIDI receive. Check all relevant settings, as well as cables and connections, then try transmitting the data again.
MIDI ERR 2	A MIDI framing error was detected in the incoming data during MIDI receive. Check all relevant settings, as well as cables and connections, then try transmitting the data again.
NOT EMPTY	The pattern which you are trying to change the meter for the pattern already contains data. Clear the pattern and try again.
PART EMPTY	The part which you are trying to insert or delete in the song is empty, i.e., the part does not contain any data.
PRESET	The pattern, song or drum kit which you are trying to edit is a factory-programmed Preset, and therefore cannot be modified. Copy the pattern, song or drum kit to a User memory and try again.

DISPLAY	COMMENTS
RECEIV BULK	Bulk data is being received from a MIDI data storage device or another RY8.
TIME OVER	MIDI bulk data transfer failed to complete within a reasonable period of time, and therefore the operation was terminated.
TS NOT MATCH	Meter of the destination pattern is different from the meter of the source pattern. Clear the destination pattern memory location and try again.

21. TROUBLESHOOTING

If you encounter one of the problems listed below, please check the possible causes and solutions before you assume that your RY8 is faulty.

PROBLEM	POSSIBLE CAUSES AND SOLUTIONS
No power	Check if the batteries are dead.
	Check if the AC adaptor is properly plugged into the AC power outlet, and snugly connected to the RY8's [DC IN] jack.
No sound selected is	Check if the [VOLUME] slider is set to a reasonable level. The [VOLUME] slider affects the level of both the [OUTPUT] jacks and the [PHONES] jack.
	Check the input and output levels of the external mixer or monitor system.
	Check the levels of the drum pads (see Drum Kit Mode, page 54) and backing tracks (see Balance Mode, page 75), or check to see if any backing tracks are muted (see Mute Mode, page 74).
	Check if the User pattern or User song that you empty.
Distorted sound	Check for any bad connections or faulty cables.
	Check the input and output levels of external mixer or amp, and adjust the balance of each accordingly, in conjunction with the output level of the RY8.

PROBLEM	POSSIBLE CAUSES AND SOLUTIONS
Song or pattern will not play	Check if you are in System Mode. The RY8 will not play in System Mode.
	Check if the RY8 System Mode Sync function is set to MIDI clock. The RY8 will not play when the sync is set to MIDI clock, since it is designated to act as a “slave” to an external clock source. You must set the Sync function to INT (“Internal”). (See page 68.)
Cannot enter System Mode	You cannot enter System Mode if the RY8 is in Pattern Record Mode or Song Record Mode. Press [REC] to exit Record Mode and try again.
Cannot change the meter	You cannot change the meter for a pattern which has already been recorded. You can only designate a meter for an empty User pattern. Clear the User pattern and try again.
Wrong pitch	Check if the Transpose value is set to normal pitch, or “0” value. (See page 76.)
Some notes will not play	The maximum polyphony of 28 notes is being exceeded. The RY8 AWM tone generator cannot play more than 28 notes at once.
Cannot hear the EXT IN signal	Check if the volume level of the guitar (i.e., the External In source signal) is turned down too low. The level of the External In source signal can only be adjusted by the source itself.
	Check if the External In Mode Mix function is turned off. (See page 62.)
Cannot trigger a voice by the EXT IN signal	Check the Sensitivity function setting in the External In Mode. (See page 64.) Also, make adjustments to guitar volume, tone and pickup settings, and make sure you’re playing only single notes.
	Check if the External In synthesizer status (i.e., Single, Octave, Harm 1, Harm 2, Harm 3, Chord) is set properly, or turned off. (See page 63.)
Will not respond to MIDI control	Check if the RY8 MIDI channel is set to match the channel of the controlling MIDI device. The RY8 has four MIDI channel settings: drum voice transmit/receive channel; program change receive channel; External In transmit channel; and Harmony transmit channel. Check if these respective channels are set properly for the type of MIDI control you are attempting.

22. SPECIFICATIONS

TONE GENERATOR	AWM - Advanced Wave Memory digital samples
	POLYPHONY - 28 notes
	VOICES - 128 drum voices and 50 normal voices
PATTERN	Pattern Play (Patterns: 200 Presets, 50 Users; 200 Backings; Swing, Clear, Copy), Pattern Record (Meter), Note Resolution (Record: 8 clocks per quarter note; Play: 24 clocks per quarter note)
SONG	Song Play (Songs: 50 Presets, 50 Users; Repeat, Chain, Clear, Copy), Song Record (Part, Measure, Pattern, Delete, Insert, Chord Select)
DRUM KIT	Drum Kit (12 Presets, 4 Users), Kit Select, Pad Assign, Pad Level, Accent, Pan, Tune, Copy, Chase; 12 Drum Pads, Pad Banks (Drum, Percussion)
EXT IN	Mix, Type/Voice (6 Voice Types and 50 Voices), Tuner, Sensitivity, Start
SYSTEM	Sync Clock, MIDI Channel, MIDI Program Change Receive Channel, Note Table/Note Number, Bulk Transmit/Receive, External In Voice Transmit Channel, Harmony Voice Transmit Channel
TEMPO	40 ~ 250
MUTE	Bass, Chord 1, Chord 2
BALANCE	Bass, Chord 1, Chord 2, External In, Harmony
TRANSPOSE	Half-steps (-12 ~ +12)
CONTROLS AND CONNECTORS	REC, TOP, BWD, STOP, PLAY, FWD, ACCENT, MODE, DELETE, AUDITION, CHORD, PAD BANK, DRUM PADS × 12, ENTER, -1, +1, ◀, ▶, VOLUME, POWER, LCD screen; OUTPUT (L/MONO, R), MIDI (IN, OUT), EXT IN, DC IN, PHONES
POWER SUPPLY AND CHARACTERISTICS	BATTERY - Six 1.5 volt AA-size (SUM-3 or R6P) or equivalent batteries
	AC ADAPTOR - Yamaha PA-3 or PA-1B
	CONSUMPTION - 3.5 watts
	OUTPUT IMPEDANCE - Line: 1kΩ; Phones: 47Ω
DIMENSIONS	188 (W) x 104 (D) x 33 (H) mm (7-1/2" × 4-1/8" × 1- 1/3")
WEIGHT	360 grams (13 oz.; without batteries)

Specifications and descriptions in this Owner's Manual are for information purposes only. Yamaha Corp. reserves the right to change or modify products or specifications at any time without prior notice. Since specifications, equipment or options may not be the same in every locale, please check with your Yamaha dealer.

23. LISTS & CHARTS

DRUM VOICE LIST

NO.	LCD DISPLAY	DRUM VOICE NAME
1	KLite	BD Light
2	KDry	BD Dry
3	KTite	BD Tight
4	KJaz1	BD Jazz 1
5	KJaz2	BD Jazz 2
6	KRock	BD Rock
7	KGate	BD Gate
8	KAna1	BD Analog 1
9	KAna2	BD Analog 2
10	KAna3	BD Analog 3
11	SDeep	SD Deep
12	STite	SD Tight
13	SRom1	SD Room 1
14	SRom2	SD Room 2
15	SORim	SD Open Rim
16	SPicl	SD Piccolo
17	SHRim	SD High Rim
18	SLite	SD Light
19	SDry	SD Dry
20	SRock	SD Rock
21	SPRim	SD Power Rim
22	SPwr1	SD Power 1
23	SPwr2	SD Power 2
24	SAmb1	SD Ambient 1
25	SAmb2	SD Ambient 2
26	SSfx1	SD SFX 1
27	SSfx2	SD SFX 2
28	SAna1	SD Analog1
29	SAna2	SD Analog2
30	BrTap	Brush Tap
31	BrSlp	Brush Slap
32	BrSw1	Brush Swirl 1
33	BrSw2	Brush Swirl 2
34	Rim	Side Stick Rim
35	RimAn	Analog Rim
36	HCl1s	Hi-Hat Closed 1
37	HCl2s	Hi-Hat Closed 2
38	HQtrO	Hi-Hat Quarter Open
39	HOpen	Hi-Hat Open
40	HPedl	Hi-Hat Pedal

NO.	LCD DISPLAY	DRUM VOICE NAME
41	HCA1	HH Analog Closed 1
42	HCA2	HH Analog Closed 2
43	HOAna	HH Analog Open
44	Ride1	Ride Cymbal 1
45	Ride2	Ride Cymbal 2
46	RdCup	Ride Cymbal Cup
47	Crsh1	Crash Cymbal 1
48	Crsh2	Crash Cymbal 2
49	Splsh	Splash Cymbal
50	Chins	Chinese Cymbal
51	CymFx	Cymbal SFX
52	Revrs	Reverse Cymbal
53	TDry1	Tom Dry 1
54	TDry2	Tom Dry 2
55	TDry3	Tom Dry 3
56	TDry4	Tom Dry 4
57	TDry5	Tom Dry 5
58	TDry6	Tom Dry 6
59	TPwr1	Tom Power 1
60	TPwr2	Tom Power 2
61	TPwr3	Tom Power 3
62	TPwr4	Tom Power 4
63	TPwr5	Tom Power 5
64	TPwr6	Tom Power 6
65	TJaz1	Tom Jazz 1
66	TJaz2	Tom Jazz 2
67	TJaz3	Tom Jazz 3
68	TJaz4	Tom Jazz 4
69	TJaz5	Tom Jazz 5
70	TJaz6	Tom Jazz 6
71	TBrs1	Tom Jazz 1
72	TBrs2	Tom Jazz 2
73	TBrs3	Tom Jazz 3
74	TBrs4	Tom Jazz 4
75	TBrs5	Tom Jazz 5
76	TBrs6	Tom Jazz 6
77	TAna1	Tom Analog 1
78	TAna2	Tom Analog 2
79	TAna3	Tom Analog 3
80	TAna4	Tom Analog 4

NO.	LCD DISPLAY	DRUM VOICE NAME
81	TAna5	Tom Analog 5
82	TAna6	Tom Analog 6
83	TElc1	Tom Electronic 1
84	TElc2	Tom Electronic 2
85	TElc3	Tom Electronic 3
86	TElc4	Tom Electronic 4
87	TElc5	Tom Electronic 5
88	TElc6	Tom Electronic 6
89	Clap	Hand Clap
90	Tmbrn	Tambourine
91	Cowbl	Cowbell
92	Vibra	Vibraslap
93	BongH	Bongo High
94	BongL	Bongo Low
95	CongM	Conga High Mute
96	CongH	Conga High Open
97	CongL	Conga Low
98	TmbIH	Timbale High
99	TmbIL	Timbale Low
100	AgogH	Agogo High
101	AgogL	Agogo Low
102	Cabas	Cabasa
103	Marac	Maracas
104	WhslS	Samba Whistle Short
105	WhslL	Samba Whistle Long
106	GuirS	Guiro Short
107	GuirL	Guiro Long
108	Clave	Claves
109	WdBIH	Wood Block High
110	WdBIL	Wood Block Low
111	CuicM	Cuica Mute
112	CuicO	Cuica Open
113	TriM	Triangle Mute
114	TriO	Triangle Open
115	Shakr	Shaker
116	Casta	Castanet
117	Stick	Sticks
118	AnCow	Analog Cowbell
119	AnCgH	Analog Conga High
120	AnCgM	Analog Conga Mid

NO.	LCD DISPLAY	DRUM VOICE NAME
121	AnCgL	Analog Conga Low
122	AnClv	Analog Claves
123	HighQ	High Q
124	ScrH	Scratch High
125	ScrL	Scratch Low
126	Fingr	Finger Snap
127	ClckH	Click High
128	ClckL	Click Low

DRUM KIT LIST

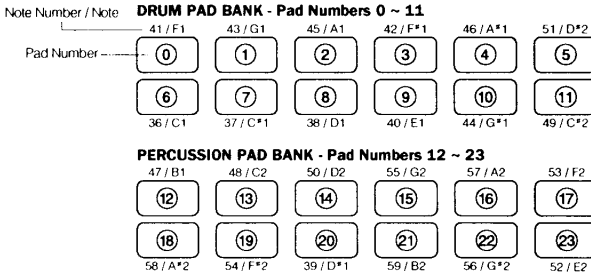
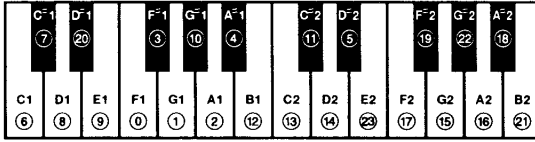

Preset Kit Number / Drum Kit Name

└ Drum Kit Number / Program Change Number

0. Stand(ard)

DRUM PAD BANK

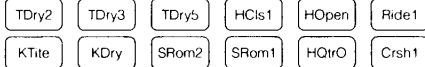

PERCUSSION PAD BANK

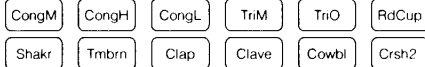

1. Bal(l)ad

DRUM PAD BANK

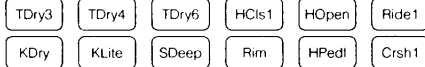

PERCUSSION PAD BANK

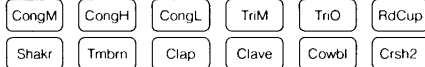

2. Rock

DRUM PAD BANK



PERCUSSION PAD BANK

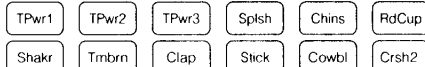

3. Power

DRUM PAD BANK

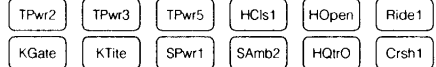

PERCUSSION PAD BANK

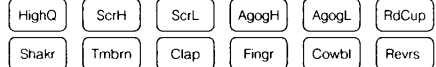

4. R&B

DRUM PAD BANK

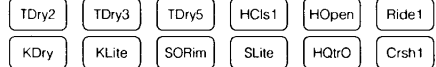

PERCUSSION PAD BANK

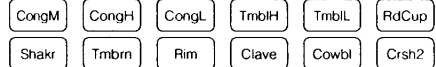

5. Funk

DRUM PAD BANK

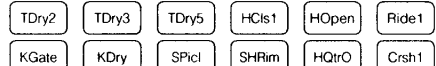

PERCUSSION PAD BANK

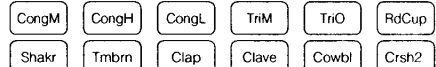

6. Rap

DRUM PAD BANK

TPwr2	TPwr3	TPwr5	HCIs2	HOpen	Ride1
KAna3	KAna2	SDry	SSfx1	HQtrO	Crsh1

PERCUSSION PAD BANK

HighQ	ScrH	ScrL	TriM	TriO	RdCup
Shakr	Tmbrn	Clap	Fingr	Cowbl	Crsh2

7. Anal(o)g

DRUM PAD BANK

TAna1	TAna3	TAna4	HCA1	HOAna	Ride2
KAna1	KAna3	SAna1	SAna2	HCA2	Splsh

PERCUSSION PAD BANK

AnCgH	AnCgM	AnCgL	ScrH	ScrL	RimAn
Shakr	Tmbrn	Clap	AnClv	AnCow	Fingr

8. Tech(no)

DRUM PAD BANK

TElc2	TElc3	TElc4	HCIs1	HOpen	Ride2
KAna3	KDry	SAna2	SSfx2	HQtrO	Crsh1

PERCUSSION PAD BANK

CongM	CongH	CongL	AgogH	AgogL	CymFx
Shakr	Tmbrn	Clap	HighQ	Cowbl	Revs

9. Jazz

DRUM PAD BANK

TJaz2	TJaz3	TJaz4	HCIs1	HOpen	Ride1
KJaz2	KJaz1	SRom2	Rim	HPedl	Crsh1

PERCUSSION PAD BANK

CongM	CongH	CongL	TriM	TriO	RdCup
Shakr	Tmbrn	SRom1	Clave	Cowbl	Crsh2

10. Brush

DRUM PAD BANK

TBrS2	TBrS3	TBrS4	HCIs1	HOpen	Ride2
KJaz2	KJaz1	BrTap	BrSw1	HPedl	Crsh1

PERCUSSION PAD BANK

CongM	CongH	CongL	GuiS	GuiL	RdCup
Shakr	Tmbrn	BrSlp	BrSw2	Clave	Crsh2

11. Latin

DRUM PAD BANK

BongH	BongL	Cabas	AgogH	AgogL	Vibra
CuicM	CuicO	TmbIH	TmbL	Marac	Crsh2

PERCUSSION PAD BANK

CongM	CongH	CongL	GuiS	GuiL	WhsS
Shakr	Tmbrn	Rim	Clave	Cowbl	WhsL

User Kit Number / Drum Kit Name

12. User00

DRUM PAD BANK

PERCUSSION PAD BANK

13. User01

DRUM PAD BANK

PERCUSSION PAD BANK

14. User02

DRUM PAD BANK

PERCUSSION PAD BANK

15. User03

DRUM PAD BANK

PERCUSSION PAD BANK

PRESET PATTERN LIST

■ Rock

PATTERN NO.	LCD DISPLAY	STYLE NAME	SECTION
0	8RckA	8-Beat Rock	Main A
1	8RckB		Main B
2	8RckC		Fill AB
3	8RckD		Fill BA
4	GlamA	Glam Rock	Main A
5	GlamB		Main B
6	GlamC		Fill AB
7	GlamD		Fill BA
8	RkMdA	Rock Middle	Main A
9	RkMdB		Main B
10	RkMdC		Fill AB
11	RkMdD		Fill BA
12	MetlA	Heavy Metal	Main A
13	MetlB		Main B
14	MetlC		Fill AB
15	MetlD		Fill BA
16	PsycA	Psychedelic	Main A
17	PsycB		Main B
18	PsycC		Fill AB
19	PsycD		Fill BA
20	T-BmA	T-Beam	Main A
21	T-BmB		Main B
22	T-BmC		Fill AB
23	T-BmD		Fill BA
24	BmbrA	Bomber	Main A
25	BmbrB		Main B
26	BmbrC		Fill AB
27	BmbrD		Fill BA
28	SlshA	Slash Metal	Main A
29	SlshB		Main B
30	SlshC		Fill AB
31	SlshD		Fill BA
32	RkShA	Rock Shuffle	Main A
33	RkShB		Main B
34	RkShC		Fill AB
35	RkShD		Fill BA
36	HRBgA	Hard Rock Boogie	Main A
37	HRBgB		Main B
38	HRBgC		Fill AB
39	HRBgD		Fill BA

PATTERN NO.	LCD DISPLAY	STYLE NAME	SECTION
40	LA-mA	LA Metal Shuffle	Main A
41	LA-mB		Main B
42	LA-mC		Fill AB
43	LA-mD		Fill BA
44	ProgA	Progressive Rock	Main A
45	ProgB		Main B
46	ProgC		Fill AB
47	ProgD		Fill BA

■ Ballad

PATTERN NO.	LCD DISPLAY	STYLE NAME	SECTION
48	8BldA	8-Beat Ballad	Main A
49	8BldB		Main B
50	8BldC		Fill AB
51	8BldD		Fill BA
52	16BdA	16-Beat Ballad	Main A
53	16BdB		Main B
54	16BdC		Fill AB
55	16BdD		Fill BA
56	PpBdA	Pop Ballad	Main A
57	PpBdB		Main B
58	PpBdC		Fill AB
59	PpBdD		Fill BA
60	RkBdA	Slow Rock Ballad	Main A
61	RkBdB		Main B
62	RkBdC		Fill AB
63	RkBdD		Fill BA
64	WalzA	Pop Swing Waltz	Main A
65	WalzB		Main B
66	WalzC		Fill AB
67	WalzD		Fill BA

■ Pop

PATTERN NO.	LCD DISPLAY	STYLE NAME	SECTION
68	WestA	West Coast Rock	Main A
69	WestB		Main B
70	WestC		Fill AB
71	WestD		Fill BA
72	LiteA	Light Pop	Main A
73	LiteB		Main B
74	LiteC		Fill AB
75	LiteD		Fill BA
76	JPopA	J - Pop	Main A
77	JPopB		Main B
78	JPopC		Fill AB
79	JPopD		Fill BA
80	AOR A	AOR	Main A
81	AOR B		Main B
82	AOR C		Fill AB
83	AOR D		Fill BA
84	HevyA	Heavy Pop	Main A
85	HevyB		Main B
86	HevyC		Fill AB
87	HevyD		Fill BA
88	RainA	Rain	Main A
89	RainB		Main B
90	RainC		Fill AB
91	RainD		Fill BA
92	DropA	Drop	Main A
93	DropB		Main B
94	DropC		Fill AB
95	DropD		Fill BA
96	DtrtA	Detroit Pop	Main A
97	DtrtB		Main B
98	DtrtC		Fill AB
99	DtrtD		Fill BA
100	FnPpA	Funk Pop	Main A
101	FnPpB		Main B
102	FnPpC		Fill AB
103	FnPpD		Fill BA

■ Dance

PATTERN NO.	LCD DISPLAY	STYLE NAME	SECTION
104	DscoA	Disco	Main A
105	DscoB		Main B
106	DscoC		Fill AB
107	DscoD		Fill BA

PATTERN NO.	LCD DISPLAY	STYLE NAME	SECTION
108	EuroA	Euro beat	Main A
109	EuroB		Main B
110	EuroC		Fill AB
111	EuroD		Fill BA
112	HousA	House	Main A
113	HousB		Main B
114	HousC		Fill AB
115	HousD		Fill BA
116	Rap A	Rap	Main A
117	Rap B		Main B
118	Rap C		Fill AB
119	Rap D		Fill BA
120	DnceA	Dance Shuffle	Main A
121	DnceB		Main B
122	DnceC		Fill AB
123	DnceD		Fill BA
124	GrndA	Ground beat	Main A
125	GrndB		Main B
126	GrndC		Fill AB
127	GrndD		Fill BA

■ R&B

PATTERN NO.	LCD DISPLAY	STYLE NAME	SECTION
128	SoulA	Soul	Main A
129	SoulB		Main B
130	SoulC		Fill AB
131	SoulD		Fill BA
132	R&B A	R&B	Main A
133	R&B B		Main B
134	R&B C		Fill AB
135	R&B D		Fill BA
136	FunkA	Funk	Main A
137	FunkB		Main B
138	FunkC		Fill AB
139	FunkD		Fill BA
140	BlusA	Blues Shuffle	Main A
141	BlusB		Main B
142	BlusC		Fill AB
143	BlusD		Fill BA
144	SBlsA	Slow Blues	Main A
145	SBlsB		Main B
146	SBlsC		Fill AB
147	SBlsD		Fill BA

■ Rock&Roll

PATTERN NO.	LCD DISPLAY	STYLE NAME	SECTION
148	TwstA	Twist	Main A
149	TwstB		Main B
150	TwstC		Fill AB
151	TwstD		Fill BA
152	50'sA	50's Rock & Roll	Main A
153	50'sB		Main B
154	50'sC		Fill AB
155	50'sD		Fill BA
156	SurfA	Surf	Main A
157	SurfB		Main B
158	SurfC		Fill AB
159	SurfD		Fill BA

■ Latin

PATTERN NO.	LCD DISPLAY	STYLE NAME	SECTION
176	SalsA	Salsa	Main A
177	SalsB		Main B
178	SalsC		Fill AB
179	SalsD		Fill BA
180	SambA	Samba	Main A
181	SambB		Main B
182	SambC		Fill AB
183	SambD		Fill BA
184	BosaA	Bossa Nova	Main A
185	BosaB		Main B
186	BosaC		Fill AB
187	BosaD		Fill BA

■ Jazz

PATTERN NO.	LCD DISPLAY	STYLE NAME	SECTION
160	BBopA	Be Bop	Main A
161	BBopB		Main B
162	BBopC		Fill AB
163	BBopD		Fill BA
164	JzBdA	Jazz Ballad	Main A
165	JzBdB		Main B
166	JzBdC		Fill AB
167	JzBdD		Fill BA
168	JzWzA	Jazz Walts	Main A
169	JzWzB		Main B
170	JzWzC		Fill AB
171	JzWzD		Fill BA
172	FusnA	Fusion	Main A
173	FusnB		Main B
174	FusnC		Fill AB
175	FusnD		Fill BA

■ Reggae

PATTERN NO.	LCD DISPLAY	STYLE NAME	SECTION
188	RegeA	Reggae	Main A
189	RegeB		Main B
190	RegeC		Fill AB
191	RegeD		Fill BA
192	LvrsA	Lovers Rock	Main A
193	LvrsB		Main B
194	LvrsC		Fill AB
195	LvrsD		Fill BA

■ Ethnic

PATTERN NO.	LCD DISPLAY	STYLE NAME	SECTION
196	EthnA	Ethno	Main A
197	EthnB		Main B
198	EthnC		Fill AB
199	EthnD		Fill BA

NORMAL VOICE LIST

NO.	LCD DISPLAY	VOICE NAME
1	Piano	Grand Piano
2	BrPno	Bright Piano
3	EGrnd	E. Grand
4	HnkTn	Honky Tonk
5	EPno1	E. Piano 1
6	EPno2	E. Piano 2
7	EPno3	E. Piano 3
8	EPno4	E. Piano 4
9	Clavi	Clavi.
10	Vibes	Vibes
11	Marmb	Marimba
12	Kalmb	Kalimba
13	Orgn1	Organ 1
14	Orgn2	Organ 2
15	AcGtr	Acoustic Guitar
16	JzGtr	Jazz Guitar
17	ClGt1	Clean Guitar 1
18	ClGt2	Clean Guitar 2
19	MtGt1	Muted Guitar 1
20	MtGt2	Muted Guitar 2
21	Dist1	Distortion Guitar 1
22	Dist2	Distortion Guitar 2
23	AcBas	Acoustic Bass
24	FnBas	Fingered Bass
25	PcBas	Picked Bass

NO.	LCD DISPLAY	VOICE NAME
26	FlBas	Fretless Bass
27	SlBas	Slap Bass
28	SyBa1	Synth Bass 1
29	SyBa2	Synth Bass 2
30	Strg1	Strings 1
31	Strg2	Strings 2
32	SySt1	Synth Strings 1
33	SySt2	Synth Strings 2
34	OrcHt	Orchestra Hit
35	Brass	Brass
36	SyBr1	Synth Brass 1
37	SyBr2	Synth Brass 2
38	Sax	Tenor Sax
39	SyLd1	Synth Lead 1
40	SyLd2	Synth Lead 2
41	SyLd3	Synth Lead 3
42	SyLd4	Synth Lead 4
43	SyPd1	Synth Pad 1
44	SyPd2	Synth Pad 2
45	SyPd3	Synth Pad 3
46	SyPd4	Synth Pad 4
47	SyFx1	Synth FX 1
48	SyFx2	Synth FX 2
49	SyFx3	Synth FX 3
50	SyFx4	Synth FX 4

MIDI DATA FORMAT

MIDI Reception

MIDI Reception Block Diagram

<MIDI Reception Condition>

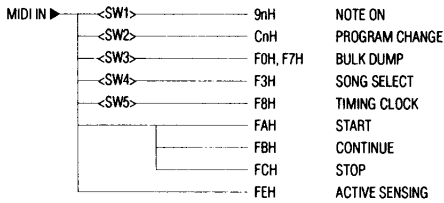

<SW1> Transmit/Receive Channel

<SW2> Program Change Receive Channel

<SW3> Pattern/Song Select Mode

<SW4> Song Select Mode

<SW5> MIDI Synchronization

Reception Data

1. System Real-time Message

TIMING CLOCK	11111000(F8H)
START	11111010(FAH)
CONTINUE	11111011(FBH)
STOP	11111100(FCH)
ACTIVE SENSING	11111110(FEH)

2. Channel Message

1) NOTE ON

STATUS	1001nnnn (9nH)	n=0-15	VOICE CHANNEL
NUMBER			
NOTE NUMBER	0kkkkkkk	k=0(C-2)-127(G8)	
VELOCITY	0vvvvvvv	NOTE ON v=1-127	

2) PROGRAM CHANGE

STATUS	1100nnnn (CnH)	n=0-15	VOICE CHANNEL
NUMBER			
PROGRAM NUMBER	0ppppppp	p=0-15	

■ When a Program Change is received, the RY8 will change the Drum Kit number corresponding to the incoming data.

3. System Common Message

1) SONG SELECT

STATUS	11110011 (F3H)	
SONG NUMBER	00ssssss	s=0-99

■ Data is received in Song Select Mode.

4. System Exclusive Message

BULK DUMP

0	01111000 (F0H)	
1	01000011 (43H)	
2	00000000 (00H)	Device Number (Fixed at 00H)
3	01111110 (7EH)	
4	00000100 (04H)	Byte count MSB
5	00001010 (0AH)	Byte count LSB
6	01001100 (4CH)	"L"
7	01001101 (4DH)	"M"
8	00100000 (20H)	" "
9	00100000 (20H)	" "
10	00110000 (30H)	"0"
11	00110002 (31H)	"2"
12	00110100 (35H)	"0"
13	00110011 (33H)	"3"
14	01000001 (41H)	"A"
15	01001100 (4CH)	"L"
16	0ddddddd	Data
:	:	
17	0sssssss	Check sum
:	:	
18	11110111 (F7H)	EOX

■ The RY8 can receive bulk data only when it is in Pattern or Song Select Mode.

■ A block consists of the Byte Count, the data bytes, and the Checksum. A number of blocks are repeatedly transmitted.

■ One byte of data is divided into 4bits MSB and 4bits LSB. It is then converted to ASCII data for transmission.

- A bulk dump consists of the following data:

System Data
MIDI Set-up Data
Drum Kit Data
Pattern Data

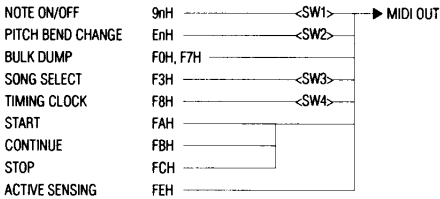

Song Data

MIDI Transmission

MIDI Transmission Block Diagram

<MIDI Transmission Condition>

<SW1> Transmit Channel

<SW2> Transmit Channel

<SW3> Transmit in Song Select Mode

<SW4> Transmit Internal synchronization

Transmission Data

1. System Real-time Message

TIMING CLOCK 11111000(F8H)
START 11111010(FAH)
CONTINUE 11111011(FBH)
STOP 11111100(FCH)
ACTIVE SENSING 11111110(FEH)

2. Channel Message

1) NOTE ON/OFF

STATUS NUMBER 1001nnnn (9nH) n=0-15 VOICE CHANNEL
NOTE NUMBER 0kkkkkk k=0(C-2)-127(G8)
0vvvvvvv NOTE ON v=1-127
00000000 NOTE OFF

2) PITCH BEND CHANGE

STATUS 1110nnn (EnH) n=0-15
EXTERNAL IN/HARMONY CHANNEL NUMBER
LSB 01111111 l=0-127
MSB 0hhhhhhh h=0-127

3. System Common Message

1) SONG SELECT

STATUS 11110011 (F3H)
SONG NUMBER 00ssssss s=0-99

- Song Select transmission occurs when in Song Select Mode.

4. System Exclusive Message

- Bulk data transmission occurs in System Mode MIDI Bulk Dump function.

1) BULK DUMP

The data is the same as that for reception. The contents regarding transmission, see "System Exclusive Message" in the previous page.



YAMAHA [Rhythm Programmer] Date: 06-OCT-1994
Model RY8 MIDI Implementation Chart Version : 1.0

MIDI IMPLEMENTATION CHART

Function	Transmitted	Recognized	Remarks
Basic Default	: 1 - 16	: 1 - 16	
Channel Changed	: 1 - 16	: 1 - 16	
Default	: 3	: 3	
Mode Messages altered	: x : *****	: x : x	
Note	: 0-127	: 0-127	
Number : True voice	: *****	: x	
Velocity Note ON	: 0 9nH, v=1-127	: 0 9nH, v=1-127	
Note OFF	: 0 9nH, v=0	: x	
After Key's	: x	: x	
Touch Ch's	: x	: x	
Pitch Bender	: 0	: x	
	: x	: x	
Control	:	:	
Change	:	:	

```

:-----+-----+-----+-----+-----+-----+-----+-----+
:Prog      : x      : 0 0 - 15      :kit select
:Change : True # : *****      :
:-----+-----+-----+-----+-----+-----+-----+-----+
:System Exclusive : o      :                :song data etc
:-----+-----+-----+-----+-----+-----+-----+-----+
:      : Song Pos. : x      :
:common : Song Sel. : o 0 - 99      :
:      : Tune      : x      :
:-----+-----+-----+-----+-----+-----+-----+-----+
:System      :Clock      : o      :
:Real Time :Commands: o      :
:-----+-----+-----+-----+-----+-----+-----+-----+
:Aux      :Local ON/OFF : x      :
:      :All Notes OFF: x      :
:Mes- :Active Sense : o      :
:sages:Reset      : x      :
:-----+-----+-----+-----+-----+-----+-----+-----+
:Note:
:
:
:
:-----+-----+-----+-----+-----+-----+-----+-----+
Mode 1 : OMNI ON, POLY Mode 2 : OMNI ON, MONO      o : Yes
Mode 3 : OMNI OFF, POLY Mode 4 : OMNI OFF, MONO     x : No

```

INDEX

[+1] and [-1] buttons	9	Drum voice list	82	Pattern play mode	30
[◀] and [▶] buttons	9	Drum voice output levels	59	Pattern record mode	35
A		E		Pattern select	31
Accent	39, 55, 59	ENTER	9	PLAY	8
Assign (drum voice)	58	External in mode	61	Polyphony	40, 53
Audition	38, 39	External in start	65	Preset Pattern List	86
B		External in voice	64	Preset patterns	21
Backing accompaniment	24	External in voice channel	69	Preset songs	26
Backing assign	34, 40	F		Program change channel	69
Backing chord	23, 32	FACT(O)RY SET	77	R	
Balance mode	75	FWD	8	Realtime record mode (pattern)	37
Basic pitch	66	G		Realtime record mode (song)	47
Beat/clock position indicators	31	Guitar synthesizer	63	Rear panel	10
Bulk dump	71	Guitar tuner	65	REC(ord)	7
BWD	7	H		Repeat	43
C		Harmony voice channel	70	S	
Chain	43	I		Sensitivity level	64
Chase	61	Initial tempo	23	Side panel	10
Chord	49	Insert (chord)	52	Song backing	42, 53
Chord Assign	49	Inserting a song pattern	48	Song mode	41
Chord root and type	50	K		Song play mode	41
Chord types	51	Kit select	56	Song record mode	45
Clear (pattern)	33	L		Song select	42
Clear (song)	44	LEVEL	59	Song start measure	42
Clock specify	49	Lists & charts	82	Start (external in)	65
Connecting external devices	14	M		Step record mode (pattern)	37
Copy (drum kit)	56	Meter	36	Step record mode (song)	46
Copy (pattern)	34	MIDI channel	68	STOP	8
Copy (song)	45	Mix	62	Swing	33
D		MODE	8	Sync clock	68
Data back-up and storage	II	Mute mode	74	Synthesizer	63
Default settings	77	Muting the backing tracks	25	System mode	67
Delete (pad data)	38, 39	N		System structure	4
Deleting a chord by event	50	Next patterns	22, 32	T	
Deleting a chord by part	52	Normal voice list	89	Tempo	23
Deleting a song pattern	47	Note numbers	72	Tempo mode	73
Demo song	18	Note table	72	Time signature	36
Drum kit create	57	P		TOP	7
Drum kit list	84	Pad bank select	55	Transpose mode	76
Drum kit mode	54	Pan	60	Tune	60
Drum voice assign	58	Pattern mode	30	Tuner (guitar)	65

Wichtiger Hinweis für die Benutzung in der Bundesrepublik Deutschland.

Bescheinigung des Importeurs

Hiermit wird bescheinigt, daß der/die/das

Gerät: Rhythm Programmer Typ: RY8

(Gerät, typ, Bezeichnung)

in Übereinstimmung mit den Bestimmungen der

VERFÜGUNG 1046/84

(Amtsblattverfügung)

funkentstört ist.

Der Deutschen Bundespost wurde das Inverkehrbringen dieses Gerätes angezeigt und die Berechtigung zur Überprüfung der Serie auf Einhaltung der Bestimmungen eingeräumt.

Yamaha Europa GmbH

(Name des Importeurs)

*Dies bezieht sich nur auf die von der Yamaha Europa GmbH Vertriebenen Produkte.

Dit produkt is gefabriceerd in overeenstemming met de radiostoringsvoorschriften van de Richtlijn van de Raad (82/499/EEG).

ΑΥΤΗ Η ΣΥΣΚΕΥΗ ΑΝΤΑΠΟΚΡΙΝΕΤΑΙ ΣΤΙΣ ΑΠΑΙΤΗΣΕΙΣ ΤΩΝ ΟΔΗΓΙΩΝ ΤΗΣ ΕΥΡΩΠΑΙΚΗΣ ΟΙΚΟΝΟΜΙΚΗΣ ΚΟΙΝΟΤΗΤΑΣ 82/499/Ε.Ο.Κ..

Este produto está de acordo com o radio de interferencia frequente requeridos do Conselho Diretivo 82/499/EEC.

Dette apparat overholder det gældende EF-direktiv vedrørende radiostøj.

Cet appareil est conforme aux prescriptions de la directive communautaire 87/308/CEE.

Diese Geräte entsprechen der EG-Richtlinie 82/499/EWG und/oder 87/308/EWG.

This product complies with the radio frequency interference requirements of the Council Directive 82/499/EEC and/or 87/308/EEC.

Questo apparecchio é conforme al D.M. 13 aprile 1989 (Direttiva CEE/87/308) sulla soppressione dei radiodisturbi.

Este producto está de acuerdo con los requisitos sobre interferencias de radio frecuencia fijados por el Consejo Directivo 87/308/CEE.

YAMAHA CORPORATION

CANADA

THIS DIGITAL APPARATUS DOES NOT EXCEED THE "CLASS B" LIMITS FOR RADIO NOISE EMISSIONS FROM DIGITAL APPARATUS SET OUT IN THE RADIO INTERFERENCE REGULATION OF THE CANADIAN DEPARTMENT OF COMMUNICATIONS.

*This applies only to products distributed by Yamaha Canada Music LTD.

LE PRESENT APPAREIL NUMERIQUE N'EMET PAS DE BRUITS RADIOELECTRIQUES DEPASSANT LES LIMITES APPLICABLES AUX APPAREILS NUMERIQUES DE LA "CLASSE B" PRESCRITES DANS LE REGLEMENT SUR LE BROUILLAGE RADIOELECTRIQUE EDICTE PAR LE MINISTERE DES COMMUNICATIONS DU CANADA.

*Ceci ne s'applique qu'aux produits distribués par Yamaha Canada Music LTD.

For details of products, please contact your nearest Yamaha or the authorized distributor listed below.

Pour plus de détails sur les produits, veuillez-vous adresser à Yamaha ou au distributeur le plus proche de vous figurant dans la liste suivante.

Die Einzelheiten zu Produkten sind bei Ihrer unten aufgeführten Niederlassung und bei Yamaha Vertragshändlern in den jeweiligen Bestimmungsländern erhältlich.

Para detalles sobre productos, contacte su tienda Yamaha más cercana o el distribuidor autorizado que se lista debajo.

NORTH AMERICA

CANADA
Yamaha Canada Music Ltd.
135 Midway Avenue, Scarborough, Ontario,
M1S 2E1, Canada
Tel: 416-298-1111

U.S.A.
Yamaha Corporation of America
6600 Orangewood Ave., Brea, Calif. CA 92620,
U.S.A.
Tel: 714-522-8001

MIDDLE & SOUTH AMERICA

MEXICO
Yamaha De Mexico S.A. de C.V.,
Departamento de ventas
Instituto Beto Gomez No.1149, Cal. Gco Del
Molod, Deltey, Toluca, 97000 Mexico, D.F.
Tel: 686-03-31

BRASIL
Yamaha Musical Do Brasil LTDA.
Ave. Rebouças 2636, São Paulo, Brasil
Tel: 55-11-833-1377

PANAMA
Yamaha De Panama S.A.
Edificio Inverness, Calle Elvira Mendez no. 83,
Piso 3, Oficina 813, Ciudad de Panama, Panama
Tel: 507-69-1311

**OTHER LATIN AMERICAN COUNTRIES
AND CARIBBEAN COUNTRIES**
Yamaha Music Latin America Corp.
600 Blue Lagoon Drive, Miami, Florida 33128,
U.S.A.
Tel: 305-261-4111

EUROPE

THE UNITED KINGDOM
Yamaha Europe Music (U.K.) Ltd.
Shepperton Drive, Uxbridge, Milton Keynes,
MK7 9BL, England
Tel: 0908-366708

IRELAND
Dunfay Limited
41D, Seaburngh Road, Donaghmore, Co. Dublin
Tel: 01-2674173

GERMANY/SWITZERLAND
Yamaha Europa GmbH,
Sternenstraße 22-24, D-2084 Bellingen, F.R. of
Germany
Tel: 04401-3838

**AUSTRIA/HUNGARY/SLOVENIA/
ROMANIA/BULGARIA**
Yamaha Music Austria GmbH,
Sollingerstrasse 20, A-1100 Wien Austria
Tel: 0222-6020980

THE NETHERLANDS
Yamaha Music Benelux B.V.,
Verkoop Administratie
Kanshofweg 180, 3526RS, Utrecht, The Netherlands
Tel: 030-838411

BELGIUM/LUXEMBOURG
Yamaha Music Benelux B.V.,
Branch office
Aethyng Impassestraat 6, 1930 Zaventem, Belgium
Tel: 32-7258220

HEAD OFFICE Yamaha Corporation, Electronic Musical Instrument Division
Nakazawa-cho 10-1, Hamamatsu, Japan 430
Tel: 053-460-2400

FRANCE
Yamaha Musique France,
Division Instruments Electroniques et de Soinse
BP 70-77312 Marais-la-Vallée Cedex 2, France
Tel: 01-64-61-6000

ITALY
Yamaha Musica Italia S.P.A.,
Cantale Division
Viale Italia 88, 20123 Lainate (Milano), Italy
Tel: 02-415-771

SPAIN
Yamaha-Instrum. Electronica Musical S.A.
Josep Joan 30, 28001, Madrid, Spain
Tel: 91-575-7293

PORTUGAL
Valentim de Carvalho C1 SA
Estrada de Ponte Salvo, Povo de Azeite 2780 Oeiras,
Portugal
Tel: 01-443-3700/415/0252

GREECE
Philipp Nokus S.A.,
Neofytou Street 13, P.O. Code 19000, Athens, Greece
Tel: 01-364-3131

SWEDEN
Yamaha Scandinavia AB
J. A. Westergrens gata 1, Box 30551, 400 02
Göteborg, Sweden
Tel: 031-494090

DENMARK
Yamaha Scandinavia Filial Denmark
Gøtteløvsvej 60, 2730 Herlev, Denmark
Tel: 44 52 49 00

FINLAND
Fazer Music Inc.
Aleksanterinkatu 11, SF-00100 Helsinki, Finland
Tel: 0433 101

NORWAY
Norski Yamaha AS
Østervoldsvei 20, 1345 Oslo
Tel: 02 24 47 90

IRELAND
Fidi H. Faloutsos
P.O. Box 85, 115 Reykjavik, Iceland
Tel: 66-39400

**EAST EUROPEAN COUNTRIES
(Except HUNGARY)**
Yamaha Europa GmbH,
Sternenstraße 22-24, D-2084 Bellingen, F.R. of
Germany
Tel: 04401-3838

AFRICA

Yamaha Corporation,
International Marketing Division
Nakazawa-cho 10-1, Hamamatsu, Japan 430
Tel: 053-460-2311

MIDDLE EAST

TURKEY/CYPRUS
Yamaha Musique France, Division Export
BP 70-77312 Marais-la-Vallée Cedex 2, France
Tel: 01-64-61-6000

OTHER COUNTRIES
Yamaha Corporation,
International Marketing Division
Nakazawa-cho 10-1, Hamamatsu, Japan 430
Tel: 053-460-2311

ASIA

HONG KONG
Tom Lee Music Co. Ltd.
119, Silvercord Tower 1, 30 Canton Road,
Tsimshatsui, Kowloon, Hong Kong
Tel: 753-0588

INDONESIA
PT. Yamaha Music Indonesia (Distributor)
PT. Nusantara
Gedung Yamaha Music Center, Jalan Jend. Gatot
Subowo Kav. 4, Jakarta 12030, Indonesia
Tel: 21-520-2377

KOREA
Comms Corporation
4131-31, Nong Dong, Songbuk-Ku, Seoul
Korea
Tel: 02-466-0021-3

MALAYSIA
Yamaha Music Malaysia, Sdn., Bhd.
18-25, Jalan SS 2/72, Petaling Jaya, Selangor,
Malaysia
Tel: 3-757-6877

PHILIPPINES
Yapagang Music Corporation
339 G. J. Poyat Avenue, P.O. BOX 800 MCPL,
Makati, Metro Manila, Philippines
Tel: 816-7554

SINGAPORE
Yamaha Music Asia Pte., Ltd.
8A, 17A, Tanjong Pagar Road, Level 7,
Singapore 1234
Tel: 354-0133

TAIWAN
Kong Hwa She Trading Co., Ltd.
No. 722, Section 1, Fuliang S. Road,
Tapei, Hsin, Taiwan, R.O.C.
Tel: 02-799-1286

THAILAND
Siam Music Yamaha Co., Ltd.
851 Photoprapha Building, Rama 1 Road,
Pittayamai, Bangkok 10330, Thailand
Tel: 2-215-3443

**THE PEOPLE'S REPUBLIC OF CHINA
AND OTHER ASIAN COUNTRIES**
Yamaha Corporation,
International Marketing Division
Nakazawa-cho 10-1, Hamamatsu, Japan 430
Tel: 053-460-2311

OCEANIA

AUSTRALIA
Yamaha Music Australia Pty. Ltd.
17-31 Market Street, South Melbourne, Vic. 3205,
Australia
Tel: 3-689-2388

NEW ZEALAND
Music House of N.Z., Ltd.
149/149 Captain Springs Road, Te Papa, Auckland,
New Zealand
Tel: 9-834-0599

**COUNTRIES AND TRUST
TERRITORIES IN PACIFIC OCEAN**
Yamaha Corporation,
International Marketing Division
Nakazawa-cho 10-1, Hamamatsu, Japan 430
Tel: 053-460-2311

YAMAHA
YAMAHA CORPORATION