

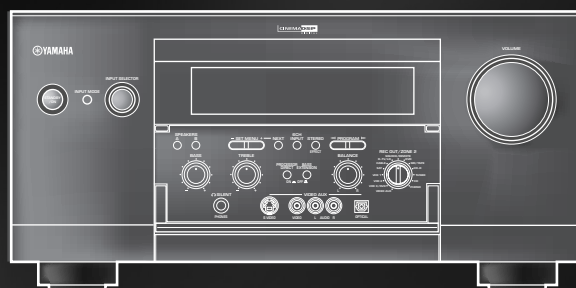

CINEMA DSP
DIGITAL

DSP-AZ1

AV Amplifier



CAUTION: READ THIS BEFORE OPERATING YOUR UNIT.

- 1 To assure the finest performance, please read this manual carefully. Keep it in a safe place for future reference.
- 2 Install this unit in a well ventilated, cool, dry, clean place with at least 30 cm on the top, 10 cm on the right and left, and 10 cm at the back of this unit — away from direct sunlight, heat sources, vibration, dust, moisture, and/or cold.
- 3 Locate this unit away from other electrical appliances, motors, or transformers to avoid humming sounds. To prevent fire or electrical shock, do not place this unit where it may get exposed to rain, water, and/or any type of liquid.
- 4 Do not expose this unit to sudden temperature changes from cold to hot, and do not locate this unit in a environment with high humidity (i.e. a room with a humidifier) to prevent condensation inside this unit, which may cause an electrical shock, fire, damage to this unit, and/or personal injury.
- 5 On the top of this unit, do not place:
 - Other components, as they may cause damage and/or discoloration on the surface of this unit.
 - Burning objects (i.e. candles), as they may cause fire, damage to this unit, and/or personal injury.
 - Containers with liquid in them, as they may cause electrical shock to the user and/or damage to this unit.
- 6 Do not cover this unit with a newspaper, tablecloth, curtain, etc. in order not to obstruct heat radiation. If the temperature inside this unit rises, it may cause fire, damage to this unit, and/or personal injury.
- 7 Do not plug in this unit to a wall outlet until all connections are complete.
- 8 Do not operate this unit upside-down. It may overheat, possibly causing damage.
- 9 Do not use force on switches, knobs and/or cords.
- 10 When disconnecting the power cord from the wall outlet, grasp the plug; do not pull the cord.
- 11 Do not clean this unit with chemical solvents; this might damage the finish. Use a clean, dry cloth.
- 12 Only voltage specified on this unit must be used. Using this unit with a higher voltage than specified is dangerous and may cause fire, damage to this unit, and/or personal injury. YAMAHA will not be held responsible for any damage resulting from use of this unit with a voltage other than specified.
- 13 To prevent damage by lightning, disconnect the power cord from the wall outlet during an electrical storm.
- 14 Take care of this unit so that no foreign objects and/or liquid drops inside this unit.
- 15 Do not attempt to modify or fix this unit. Contact qualified YAMAHA service personnel when any service is needed. The cabinet should never be opened for any reasons.
- 16 When not planning to use this unit for long periods of time (i.e. vacation), disconnect the AC power plug from the wall outlet.
- 17 Be sure to read the “TROUBLESHOOTING” section on common operating errors before concluding that this unit is faulty.
- 18 Before moving this unit, press **STANDBY/ON** to set this unit in the standby mode, and disconnect the AC power plug from the wall outlet.
- 19 **VOLTAGE SELECTOR** (China and General models only)
The **VOLTAGE SELECTOR** on the rear panel of this unit must be set for your local main voltage BEFORE plugging into the AC main supply.
Voltages are 110/120/220/240 V AC, 50/60 Hz.

This unit is not disconnected from the AC power source as long as it is connected to the wall outlet, even if this unit itself is turned off. This state is called the standby mode. In this state, this unit is designed to consume a very small quantity of power.

■ For U.K. customers

If the socket outlets in the home are not suitable for the plug supplied with this appliance, it should be cut off and an appropriate 3 pin plug fitted. For details, refer to the instructions described below.

Note

- The plug severed from the mains lead must be destroyed, as a plug with bared flexible cord is hazardous if engaged in a live socket outlet.

■ Special Instructions for U.K. Model

IMPORTANT

THE WIRES IN MAINS LEAD ARE COLOURED IN ACCORDANCE WITH THE FOLLOWING CODE:

Blue: NEUTRAL

Brown: LIVE

As the colours of the wires in the mains lead of this apparatus may not correspond with the coloured markings identifying the terminals in your plug, proceed as follows:

The wire which is coloured BLUE must be connected to the terminal which is marked with the letter N or coloured BLACK.
The wire which is coloured BROWN must be connected to the terminal which is marked with the letter L or coloured RED.
Making sure that neither core is connected to the earth terminal of the three pin plug.

Contents

INTRODUCTION	3
Features	4
Controls and functions	6
PREPARATIONS	13
Speaker system configurations	14
Speaker placement	16
Connections	18
On-screen displays (OSD)	33
Speaker mode settings	34
Speaker output levels	38
BASIC OPERATIONS	41
Basic playback	42
Basic recording	50
ADVANCED OPERATION	51
Set menu items	52
Remote control features	64
Adjusting the levels of the effect speakers	81
Sleep timer	82
Zone 2	83
SOUND FIELD PROGRAMS	85
Digital sound field processing (DSP)	86
Hi-Fi DSP-sound field program	88
CINEMA-DSP sound field program	90
Sound field program parameter editing	95
Digital sound field parameter descriptions	96
APPENDIX	101
Troubleshooting	102
CINEMA EQ frequency characteristics	105
Reference chart for the input and output jacks	106
Specifications	107

CHECKING THE PACKAGE CONTENTS

Check your package to make sure it has the following items.

Remote control

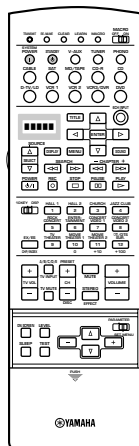

Batteries (3) (LR6)

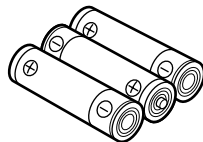

Power cord (except for U.K. model)

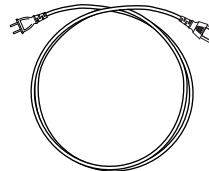

Introduction

This section describes the features of the DSP-AZ1, and its controls and functions.

FEATURES	4
-----------------------	----------

CONTROLS AND FUNCTIONS	6
-------------------------------------	----------

Front panel	6
Remote control	8
Front panel display	11
Rear panel	12

FEATURES

■ Built-in 8-channel power amplifier

- Main: 130 W + 130 W (8Ω) RMS Output Power, 0.015% THD, 20 – 20,000 Hz
- Center: 130 W (8Ω) RMS Output Power, 0.015% THD, 20 – 20,000 Hz
- Rear: 130 W + 130 W (8Ω) RMS Output Power, 0.015% THD, 20 – 20,000 Hz
- Front: 45 W + 45 W (8Ω) RMS Output Power, 0.05% THD, 1 kHz
- Rear center: 130 W (8Ω) RMS Output Power, 0.015% THD, 20 – 20,000 Hz

■ Digital Sound Fields (DSP)

Technological advances in sound reproduction over the last 30 years have enhanced the listening experience with improved clarity, precision, and power. However, something has been missing: the atmosphere and acoustic ambience of the public venue. Our Yamaha engineers have extensively researched the nature of sound acoustics and the way sound reflects inside a room. We sent these engineers to famous theaters and concert halls around the world to measure the acoustics of those venues with sophisticated microphones. The data they collected is used to recreate these environments in digital sound fields. Some of these digital sound fields have been created using data measured at the original venue; others have been created from combinations of data to form unique environments for specific purposes. Some have been designed especially for music, and others especially for movies. Of course, this only solves half of the problem. Because these engineers have no way of knowing the acoustics of your entertainment room, we have made it possible for you to adjust the various parameters of this data to tailor each virtual venue to your taste. You can use these sound fields to enhance any source and in combination with any of the following surround sound technologies.

■ CINEMA-DSP: Dolby Digital + DSP and DTS + DSP

The Dolby Digital system and DTS system show their full capability in large movie theaters, because feature film soundtracks are designed to be reproduced in such environments. It is difficult to recreate a sound environment similar to a movie theater in your entertainment room because of the room size, wall materials, and the number of speakers in your entertainment system. Yamaha DSP technology makes it possible for you to enjoy nearly the same sound experience as that of a large movie theater in your entertainment room by compensating for lack of presence and dynamics in your entertainment room with Yamaha's original digital sound fields combined with Dolby Digital or DTS soundtracks.

■ Virtual CINEMA DSP and SILENT CINEMA DSP

Yamaha developed the Virtual CINEMA DSP algorithm which allows you to experience the virtual sound fields without surround speakers. This makes it possible for the DSP-AZ1 to produce a full surround sound catering to the number of speakers you have. The DSP-AZ1 also has a SILENT CINEMA DSP algorithm which is achieved by the crosstalk processing applying the precise Head Related Transfer Function. You can therefore enjoy listening to the CINEMA DSP soundfields on headphones.

■ Various decoders to support the newest sound effect technology

This unit is equipped with the following signal format decoders.



• Dolby Digital and Dolby Digital EX

The Matrix decoder enables 6.1-channel playback of the 5.1-channel sources by extracting the rear center channel signals from the rear L/R channel signals.

• DOLBY PRO LOGIC

• DOLBY PRO LOGIC II

DOLBY PRO LOGIC II is the improved technique to decode vast numbers of existing Dolby Surround programs. This new technology enables a discrete 5-channel playback with two left and right main channels, a center channel, and two left and right rear channels compared with one limited rear channel for the conventional Pro Logic technology. Also the music mode is available for 2-channel sources in addition to the movie mode.



• DTS and DTS ES

The DSP-AZ1 is also equipped with a DTS decoder, which uses a 5.1-channel system to create a full surround sound environment. It was developed as a way to replace the analog soundtracks of movies with six channels of digital sound. In comparison with Dolby Digital, DTS uses less compression to store the sound information. The newly presented DTS ES system reproduces digital sound similar to Dolby Digital EX. The use of the rear center speaker along with the existing 5.1-channel speakers provides a fully immersive cinematic audio experience.

• DTS Neo: 6

Neo: 6 decodes the conventional 2-channel sources for 6-channel playback by the specific decoder. It enables playback with the full-range channels with higher separation just like digital discrete signal playback. Two modes are available; "Music mode" for playing music sources and "Cinema mode" for movies.

• DTS 96/24

DTS 96/24 achieves the high quality playback with all 5.1 channels at the sampling frequency 96 kHz/24 bit.

■ Various input and output jacks

The DSP-AZ1 has various output jacks for audio and video signals as well as a digital recording output jack. Many input jacks are also available for connection to multiple audio-video sources. All the video inputs and outputs have S-video jacks in addition to standard composite video jacks for improved video picture quality. Component video input and output jacks are also available to deliver the excellent video signals from DVD players and other high quality video sources. The coaxial and optical digital signal jacks (provided for direct transmission of digital signals) automatically detect Dolby Digital, DTS, and PCM signals. A demodulator circuit is built into the Dolby Digital RF input so you can connect it directly to the Dolby Digital RF signal output on your LD player. Additionally, there are six audio inputs for discrete multichannel reproduction from an external decoder.

The DSP-AZ1 also comes with a monaural subwoofer jack and split subwoofer jacks which can reproduce delicate but powerful low frequency effects.

■ Multi-function remote control

The remote control can operate other audio-video components once you program the remote control using the manufacturer code and Learn feature.



Manufactured under license from Dolby Laboratories.

“Dolby”, “Pro Logic”, and the double-D symbol are trademarks of Dolby Laboratories.



“DTS”, “DTS-ES Extended Surround” and “Neo: 6” are trademarks of Digital Theater System, Inc.

CONTROLS AND FUNCTIONS

Front panel

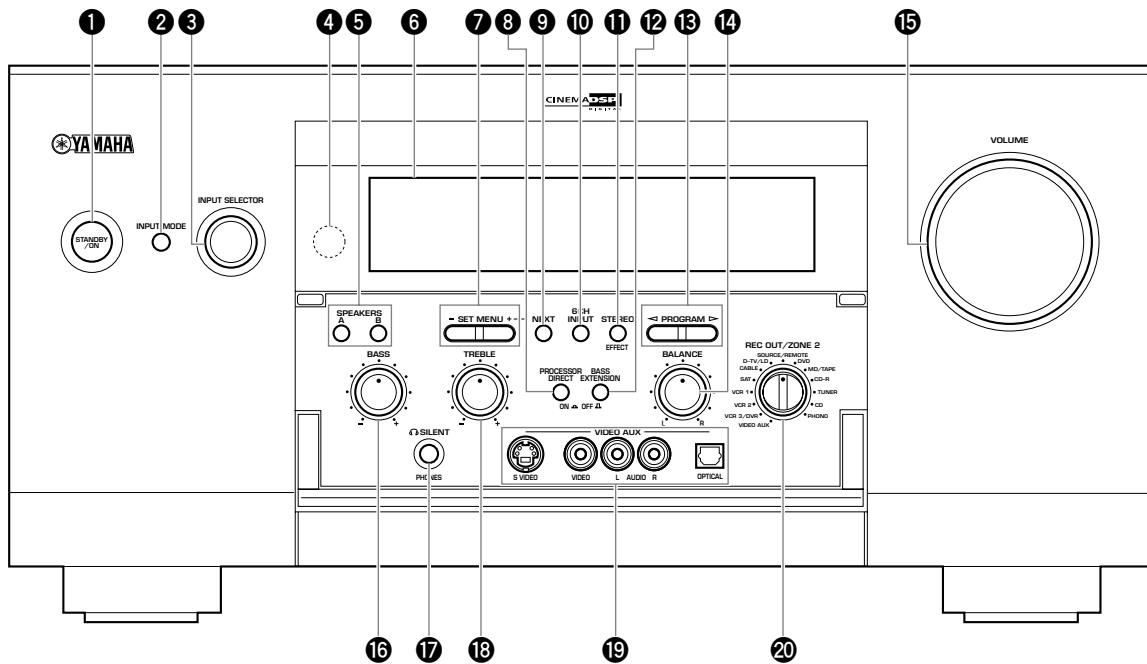

1 STANDBY/ON

Turns this unit on (On mode) and off (Standby mode). When you turn on this unit, you will hear a click and there will be a 4 to 5-second delay before this unit can reproduce sound. In Standby mode, this unit consumes a small amount of power so it can respond to the remote control.

2 INPUT MODE

Selects the mode of input for sources that output two or more types of signals to this unit (see page 44).

Caution

- You cannot control the input mode when you select **6CH INPUT** as the input source.

3 INPUT SELECTOR

Selects the input source (**D-TV/LD, CABLE, SAT, VCR 1, VCR 2, VCR3/DVR, V-AUX, DVD, MD/TAPE, CD-R, TUNER, CD, PHONO**) you want to listen to or watch (see page 42).

4 Remote control sensor

Receives signals from the remote control.

5 SPEAKERS A/B

When pushed in (ON), these buttons turn on the set of main speakers connected to the **A** and/or **B** terminals on the rear panel.

6 Front panel display

Shows information about the operational status of this unit (see page 11).

7 SET MENU +/-

Adjusts the settings and parameter values of SET MENU items.

8 PROCESSOR DIRECT ON/OFF

When pushed in (ON), **BASS, TREBLE, BALANCE, and BASS EXTENSION** are bypassed, eliminating any alteration of the original signal.

9 NEXT

Displays SET MENU items. This button works like ∇ on the remote control when using the SET MENU (see page 53).

10 6CH INPUT

Switches between 6CH INPUT mode and normal input modes. 6CH INPUT mode takes priority over the source selected with **INPUT SELECTOR**.

You cannot use DSP sound field programs while using an external decoder.

11 STEREO/EFFECT

Switches the effect speakers (center, front effect, rear and rear center) on and off. If you turn off the output of these speakers using **STEREO/EFFECT**, all DTS and Dolby Digital audio signals are directed to the main left and right channels except for the LFE channel.

Cautions

- When DTS or Dolby Digital signals are mixed, the left and right main channel signal levels may not match.
- If "1B MAIN SP" on the SET MENU is set to "SMALL" and "1E LFE/BASS OUT" is set to "SW", or "1E LFE/BASS OUT" is set to "BOTH", the LFE signals will be output from the subwoofer.

12 BASS EXTENSION ON/OFF

When pushed in (ON), this feature boosts the bass frequency of the left and right main channels by +6 dB (60 Hz) while maintaining overall tonal balance. This boost is useful if you do not use a subwoofer.

However, this boost may not be noticeable if the main speakers are set to "SMALL" and the bass output mode is set to "SW."

13 PROGRAM </>

Selects the sound field program (see page 46).

Selecting a sound field program turns on the effect.

14 BALANCE

Controls the balance of the sound levels coming from the left and right main speaker(s). Setting this control to the center position is appropriate for most situations.

15 VOLUME

Controls the output level of all audio channels.

This does not affect the REC OUT level.

16 BASS

Adjusts the low frequency response for the left and right main speaker channels.

Turn the control to the right to increase the low frequency response and turn the control to the left to decrease the low frequency response.

Caution

- If you increase or decrease the low frequency sound to an extreme level, the tonal quality from the center, front effect, rear center, and rear speakers may not match that of the left and right main speakers.

17 PHONES

Outputs audio signals for private listening using headphones.

Cautions

- When you connect headphones, no signals are output to the **PREOUT** jacks or the speakers.
- When the signal input into the **6CH INPUT** jack is being played back, only the left and right channel signals are output through the headphones.

18 TREBLE

Adjusts the high frequency response for the left and right main channels.

Turn the control to the right to increase the high frequency response and turn the control to the left to decrease the high frequency response.

Caution

- If you increase or decrease the high frequency sound to an extreme level, the tonal quality from the center, front effect, rear center, and rear speakers may not match that of the left and right main speakers.

19 VIDEO AUX

Inputs audio and video signals from a portable external source such as a video camera.

20 REC OUT/ZONE 2

Selects the source you want to direct to the audio/video recorder and **ZONE 2** outputs independent of the source you are listening to in the main room. When set to the **SOURCE/REMOTE** position, the input source is directed to all outputs.

Opening and closing the front panel door

When you are not operating the controls behind the front panel door, close the door.

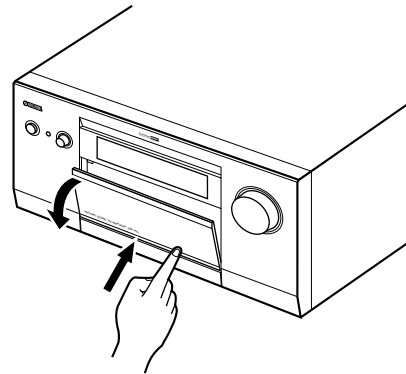

Remote control

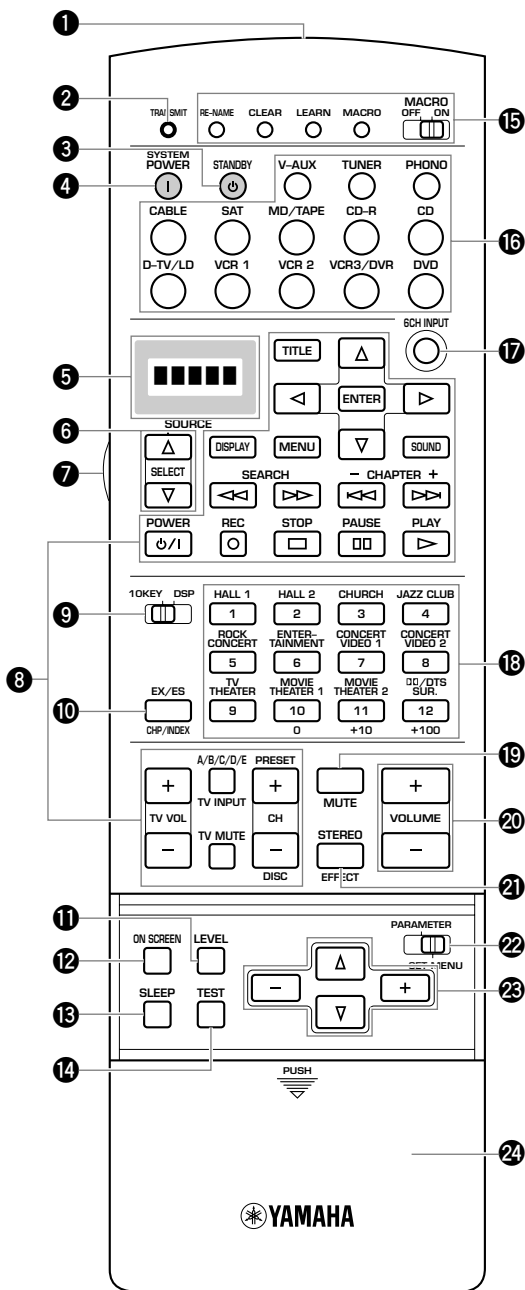

1 Infrared window

Outputs infrared control signals. Aim this window at the component you want to operate.

2 TRANSMIT

Flashes while the remote control is sending signals.

3 STANDBY

Sets this unit in the standby mode.

4 SYSTEM POWER

Turns on the power of this unit.

5 Display window

Shows the source component that you select to control.

6 SOURCE SELECT Δ/∇

Selects the source component without switching the input.

7 LIGHT

Turns the light on or off.

When you press this button once, the light turns on for about 10 seconds. Press again to turn off the light.

8 Operation section

Provides functions such as play, stop, skip, etc. for operating your other components.

Caution

- You can operate the other components that are not Yamaha with this remote control after programming their remote control functions (Learn) or setting the manufacturer code.

9 10KEY/DSP

Selects the numeric button (10KEY) mode or DSP mode. You can use the 13 buttons to select numbers or DSP programs directly according to the position of this switch.

10 EX/ES

Turns on or off the Dolby Digital EX or DTS ES decoder with 10KEY/DSP set to the DSP position.

11 LEVEL

Selects the effect speaker channels (center, front, rear and subwoofer) so you can adjust their level independently. Press this button repeatedly to select the effect speaker channel you want to adjust, then use + or - to adjust the level.

12 ON SCREEN

Selects the On-Screen Display mode for your video monitor (see page 33).

13 SLEEP

Sets the sleep timer.

14 TEST

Selects the test mode.

**15 Remote control programming function buttons/
MACRO switch**

Programs new remote control functions, sets manufacturer codes, renames the input source names, or uses the Macro feature.

16 Input section

Selects the input source.

Press an input selector button repeatedly to select the input mode.

17 6CH INPUT

Switches to the 6CH INPUT mode when using an external decoder (see page 42).

18 DSP program group/numeric buttons

Select DSP programs or numbers according to the position of **10KEY/DSP**. (Press a button repeatedly to select a DSP program within that group.)

19 MUTE

Mutes the sound. While the mute function is on, "MUTE ON" appears on the front panel display.

20 VOLUME +/-

Increases or decreases the volume level.

21 STEREO/EFFECT

Switches the effect speakers (center, front, rear, and rear center) on and off. If the output of these speakers is switched off, all DTS and Dolby Digital audio signals are directed to the main left and right channels except for the LFE channel.

22 PARAMETER/SET MENU

Selects the PARAMETER mode or SET MENU mode.

You can use $\Delta/\nabla/+/-$ to adjust DSP program parameter values or SET MENU items according to the position of this switch.

23 $\Delta/\nabla/+/-$

Selects and adjusts DSP program parameters and SET MENU items according to the position of **PARAMETER/SET MENU**.

24 Cover

Slides down to show the setup buttons.

■ Installing batteries in the remote control

- 1 Open the battery compartment cover.

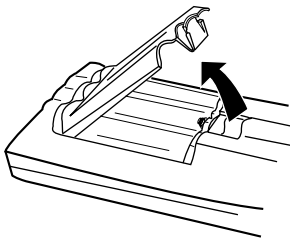

- 2 Insert three supplied batteries (LR6) in the correct direction by aligning the + and – marks on the batteries with the polarity markings (+ and –) on the inside of the battery compartment.

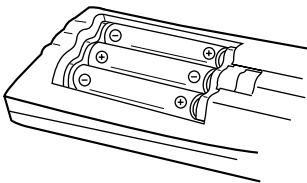

- 3 Replace the cover as pressing until it snaps into place.

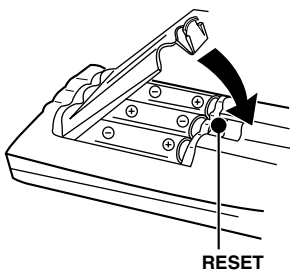

Cautions

- Insert the batteries in the correct direction by aligning the + and – marks on the batteries with the polarity illustrations (+ and –) inside the battery compartment.
- Change the batteries periodically.
- Do not use old batteries together with new ones.
- Do not use different types of batteries (such as alkaline and manganese batteries) together. Read the packaging carefully as these different types of batteries may have the same shape and color.

■ About changing batteries

As the batteries wear out, the operating range of the remote control decreases and the **TRANSMIT** indicator does not flash or its light becomes dim. When you notice any of these conditions, change all of the batteries. After you insert new batteries, be sure to push **RESET** in the battery compartment using a ball point pen or similar object before using the remote control. (This does not clear the contents of the memory.)

Caution

- If the remote control is without batteries for more than 3 minutes, or if exhausted batteries remain in the remote control, the contents of the memory may be cleared. When the memory is cleared, insert new batteries, set up the manufacturer code and program any acquired functions that may have been cleared.

■ Using the remote control

The remote control transmits a directional infrared beam. Be sure to aim the remote control directly at the remote control sensor on the main unit during operation.

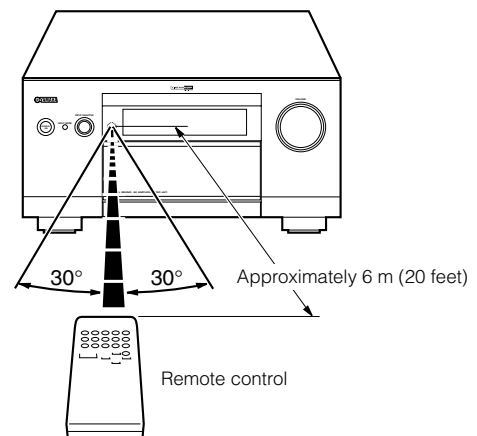

Cautions

- When the sensor is covered or there is a large object between the remote control and the main unit, the sensor cannot receive signals.
- The sensor may not be able to receive signals properly when it is exposed to direct sunlight or a strong artificial light (such as a fluorescent or strobe light). In this case, change the direction of the light or reposition the main unit to avoid direct lighting.
- Handle the remote control with care.
- Do not spill water or other liquids on the remote control.
- Do not drop the remote control.
- Do not leave or store the remote control in the following types of conditions:
 - ① high humidity or temperature such as near a heater, stove or bath
 - ② dusty places
 - ③ in places subject to extremely low temperatures

Front panel display

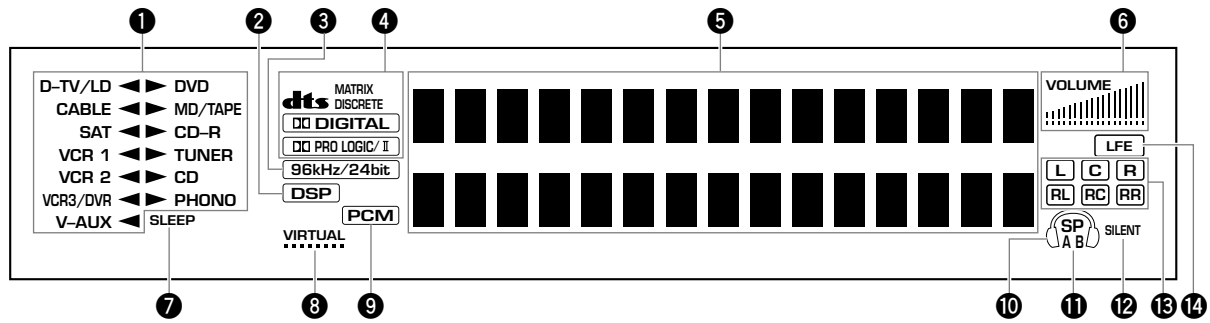
**1 Input source indicator**

Shows the current input source with the arrow-shaped cursor.

2 DSP indicator

Lights up when you select a digital sound field program.

3 96kHz/24bit indicator

Lights up when the DTS 96/24 signal is input to this unit.

4 Processor indicators

When any function of DTS, MATRIX, DISCRETE, **DIGITAL**, and **PRO LOGIC II** is activated, its indicator lights up.

5 Multi-information display

Shows the current DSP program and other information when adjusting or changing settings.

6 VOLUME level indicator

Indicates the volume level.

7 SLEEP indicator

Lights up while the sleep timer is on.

8 VIRTUAL indicator

Lights up when using Virtual CINEMA DSP (see page 49).

9 PCM indicator

Lights up when this unit is reproducing PCM (Pulse Code Modulation) digital audio signals.

10 Headphones indicator

Lights up when headphones are connected.

11 SPEAKERS A/B indicator

Lights up according to which set of main speakers are selected. Both indicators light up when both sets of speakers are selected.

12 SILENT indicator

Lights up when headphones are connected with the sound effect (see "SILENT CINEMA DSP" on page 49).

13 Input channel indicator

Indicates the channel components of input signals being received.

14 LFE indicator

Lights up when the input signal contains the LFE signal.

Rear panel

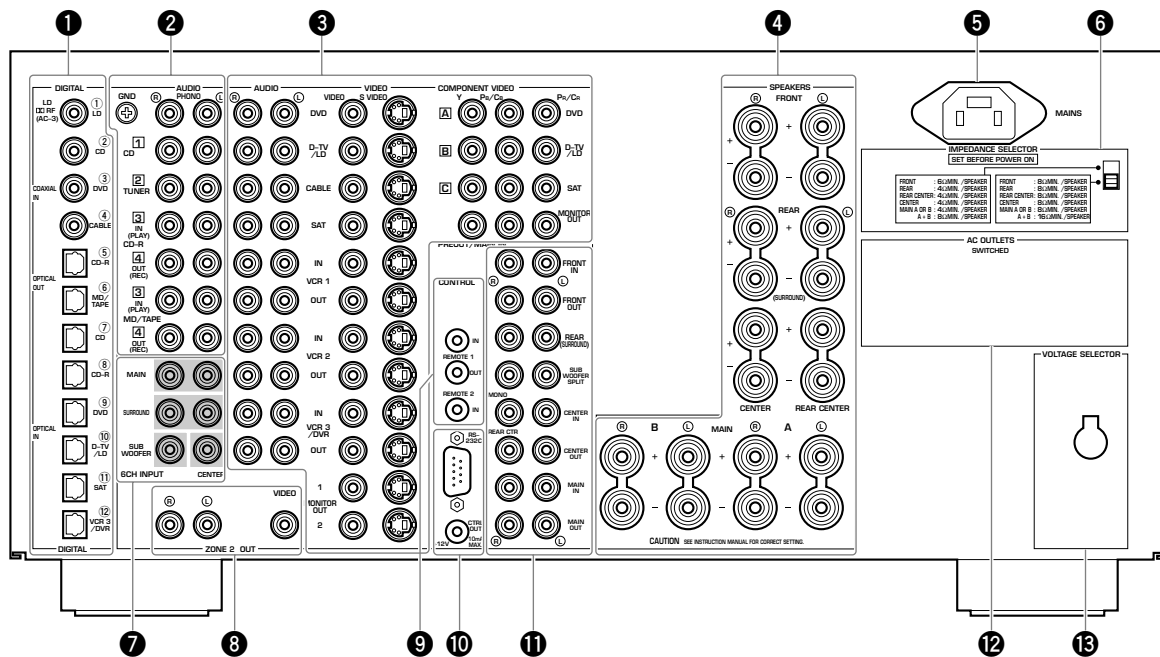

(General and China models)

1 DIGITAL OPTICAL/COAXIAL jacks

See page 19 for detailed information.

2 Audio component jacks

See pages 19 and 20 for connection information.

3 Video component jacks

See pages 21 to 28 for connection information.

4 Speaker terminals

See pages 29 and 30 for connection information.

5 MAINS

Use this inlet to plug in the supplied power cord.

6 IMPEDANCE SELECTOR

Use this switch to match the amplifier output to your speaker impedance. Turn off the power before you change the setting of this switch (see page 30).

7 6CH INPUT jacks

See page 32 for connection information.

8 ZONE 2 OUT jacks

See page 83 for connection information.

9 REMOTE 1 IN/OUT/REMOTE 2 IN jacks

See page 83 for connection information.

10 RS-232C/CTRL OUT +12V terminals

These are control expansion terminals for commercial use. Consult your dealer for details.

11 PREOUT/MAIN IN jacks

See page 31 for connection information.

12 AC OUTLET(S)

Use these outlets to supply power to your other audio/video component.

13 VOLTAGE SELECTOR (General and China models)

See page 32.

Preparations

This section explains how to make preparations (speaker selection and placement, subwoofer usage, connection with other components, speaker mode setting, and speaker level adjustment) to fully use the DSP-AZ1.

SPEAKER SYSTEM CONFIGURATIONS	14
SPEAKER PLACEMENT	16
CONNECTIONS	18
Before connecting components	18
Connecting digital jacks	19
Connecting audio components	19
Connecting video components	21
Connecting speakers	29
Connecting other components	31
Connecting the power supply cords	32
ON-SCREEN DISPLAYS (OSD)	33
OSD modes	33
Selecting the OSD mode	33
SPEAKER MODE SETTINGS	34
SPEAKER OUTPUT LEVELS	38
TEST DOLBY SUR.	39
TEST DSP	40

SPEAKER SYSTEM CONFIGURATIONS

The most complete speaker configuration consists of eight speakers: the left and right main speakers, a center speaker, the left and right rear speakers, the left and right front effect speakers, and a rear center speaker. If you do not use eight speakers, you can direct the signals for speakers that are not in your system to other speakers in your configuration. A subwoofer can be used with any of these configurations to produce a fuller sound.

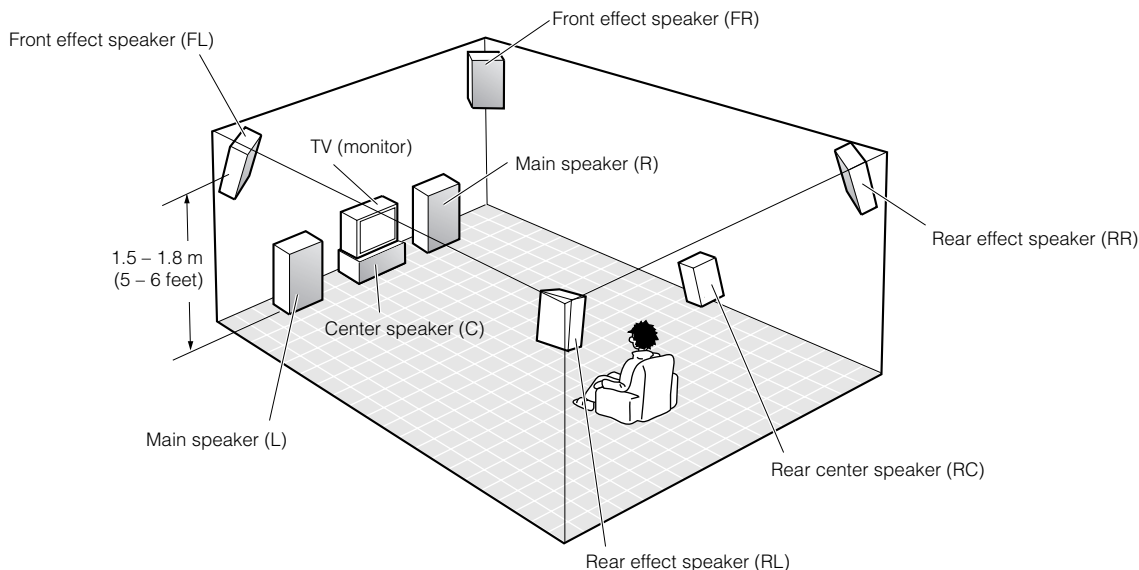

■ 8-speaker configuration –full CINEMA-DSP–

When you reproduce feature film software, this configuration fully expresses the powerful and realistic sound qualities of 70 mm multitrack audio. The dialogue is positioned as if it were coming from directly on the screen, the sound effect is positioned slightly behind the screen, and the soundtrack music is positioned even further behind the screen to express the width and depth of the overall presentation. This configuration makes the most of this unit's capability.

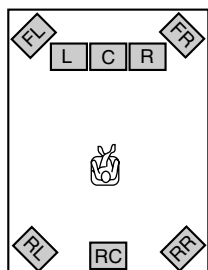

Speakers to be used

- Main L/R
- Center
- Rear L/R
- Front effect L/R
- Rear center

■ 6-speaker configuration –Hi-Fi DSP–

This configuration is used the most for audio playback with Hi-Fi DSP. It does not position the dialogue sound as well as a 7- or 8-speaker configuration. However, it creates a dynamic DSP (Digital Sound Field Processor) sound field which adds depth to the sound. For this speaker configuration, change SET MENU item "1A CENTER SP" to "NONE" and "1D REAR CT SP" to "NONE".

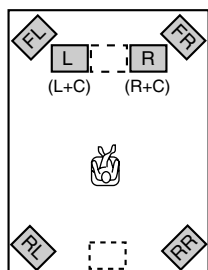

Speakers to be used

- Main L/R
- Rear L/R
- Front effect L/R

5-speaker configuration –standard 5.1 channel–

This configuration does not express the height of the sound field as well as the 7- or 8-speaker configuration. However, it positions the dialogue sound as coming directly from the screen.

For this speaker configuration, change SET MENU item “1F FRONT EFCT SP” to “NONE” and “1D REAR CT SP” to “NONE”.

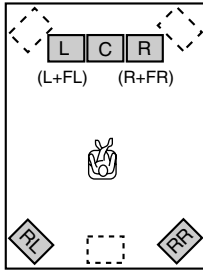

Speakers to be used

- Main L/R
- Center
- Rear L/R

4-speaker configuration –minimum requirement–

In this configuration, the center speaker signals and front effect speaker signals are directed to the left and right main speakers.

For this speaker configuration, change SET MENU item “1A CENTER SP” to “NONE”, item “1F FRONT EFCT SP” to “NONE”, and item “1D REAR CT SP” to “NONE”.

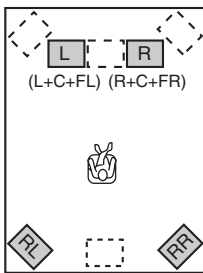

Speakers to be used

- Main L/R
- Rear L/R

Speaker configurations and speaker mode

Select the appropriate speaker mode depending on the speaker configuration. See “SPEAKER MODE SETTINGS” on page 34 for details.

	8 speakers	7 speakers	6 speakers	5 speakers	4 speakers
1A CENTER SP (Center)	LRG/SML	LRG/SML	NONE	LRG/SML	NONE
1B MAIN SP (Main L/R)	LARGE/SMALL	LARGE/SMALL	LARGE/SMALL	LARGE/SMALL	LARGE/SMALL
1C REAR L/R SP (Rear L/R)	LRG/SML	LRG/SML	LRG/SML	LRG/SML	LRG/SML
1D REAR CT SP (Rear center)	LRG/SML	NONE	NONE	NONE	NONE
1F FRONT EFCT SP (Front effect L/R)	YES	YES	YES	NONE	NONE

Note

- As a guideline, select “LARGE” for the larger speaker diameter than 16 cm, and “SMALL” for the smaller speaker diameter than 15 cm. Change the speaker mode setting as listening to the actual playback sound if it does not meet your expectation.

SPEAKER PLACEMENT

Refer to the following diagram when you place the speakers.

Caution

- Use magnetically shielded speakers. If this type of speakers still creates the interference with a monitor, place the speakers away from the monitor.

■ Placing the main speakers

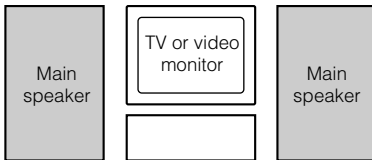

Place the left and right main speakers an equal distance from the main listening position. If you have a TV or video monitor in your system, the distance of each speaker from each side of the TV or video monitor should be the same.

■ Placing the center speaker

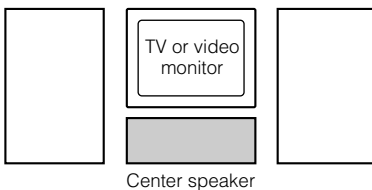

If you have a TV or video monitor in your system, align the front face of the center speaker with the front face of the monitor. Place the speaker as close to the monitor as possible, such as directly over or under the monitor. If you place the speaker under the monitor, the front effect speakers can adjust the height of the sound to correspond with the action on the screen (depending on the listener's position). If you have a projection screen in your system, place the center speaker under the screen. Be sure to align the speaker with the center of the screen.

■ Placing the front effect, rear and rear center speakers

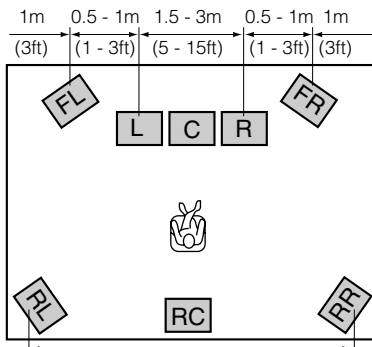

This distance can be farther than the front effect speakers'.

These speakers should be placed about 0.5 – 1 m (1 – 3 feet) outside the main speakers and in the front of the room. They should be turned toward the main listening position. Place the rear speakers in the back of the room so they face the main listening position. The rear speakers can be placed farther apart than the front effect speakers. Place these speakers at the height of 1.5 m when listening as sitting on the floor or 1.8 m when listening as sitting on the chair.

Once you begin listening to programs, continue to adjust the speaker placement until you obtain a balanced sound from the main speakers and the front effect and rear speakers.

■ When you use a projection screen

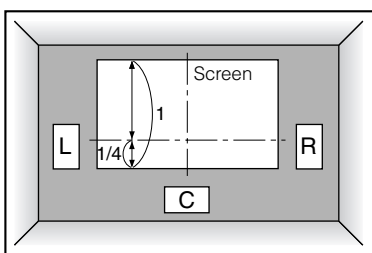

Place the speakers as shown in the illustration.

The main speakers should be placed about one-quarter of the way up from the bottom of the screen.

Place the center speaker in the center and directly under the screen. The center speaker provides precise dialogue localization.

When you use a projection screen with your system, the front effect speakers provide better effect quality. The CINEMA-DSP sound field programs (see pages 90 to 94) raise the sound from the center speaker upward and provide natural sound corresponding with the video images.

■ Placing the subwoofers

Place the front subwoofer near the main speakers. Turn it slightly toward the center of the room to reduce wall reflections.

If you use a rear subwoofer, place it behind the main listening position. The placement of the rear subwoofer is not critical because of the ultra low frequencies of the sound being reproduced.

By adding a high quality subwoofer to the speaker configurations shown on page 14, you can enjoy more powerful and realistic movie effects, even if your main speakers are large.

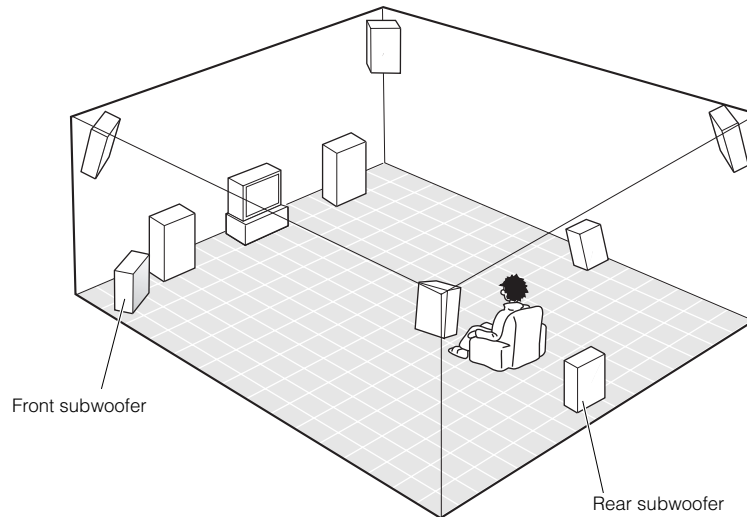

Note

- If you use different brands of speakers (with different tonal qualities) in your configuration, the tone of a moving human voice and other types of sound may not shift smoothly. We recommend that you use speakers from the same manufacturer or speakers with the same tonal quality.

You can also adjust the output levels and equalization of your effect speakers using the SET MENU (see pages 56 and 57).

If you are using small speakers, the addition of a subwoofer will reinforce the sound effects of movies.

CONNECTIONS

Before connecting components

CAUTION

Never connect this unit and other components to mains power until all connections between components have been completed.

- Some components require different connection methods and have different jack names. Refer to the operation instructions for each component also.
- Input and output jacks for the pin jacks are color-coded depending on the signal type.
- When connecting input and output jacks, use commercially available cables (pin-plug cable, fiber-optic cable, coaxial cable and S-Video cable).
- When this unit interferes with the other components (such as a TV and tuner), replace this unit apart from those components. To prevent the interference with a TV or tuner, it is recommended that an external antenna is placed and coaxial cables are used for connections.

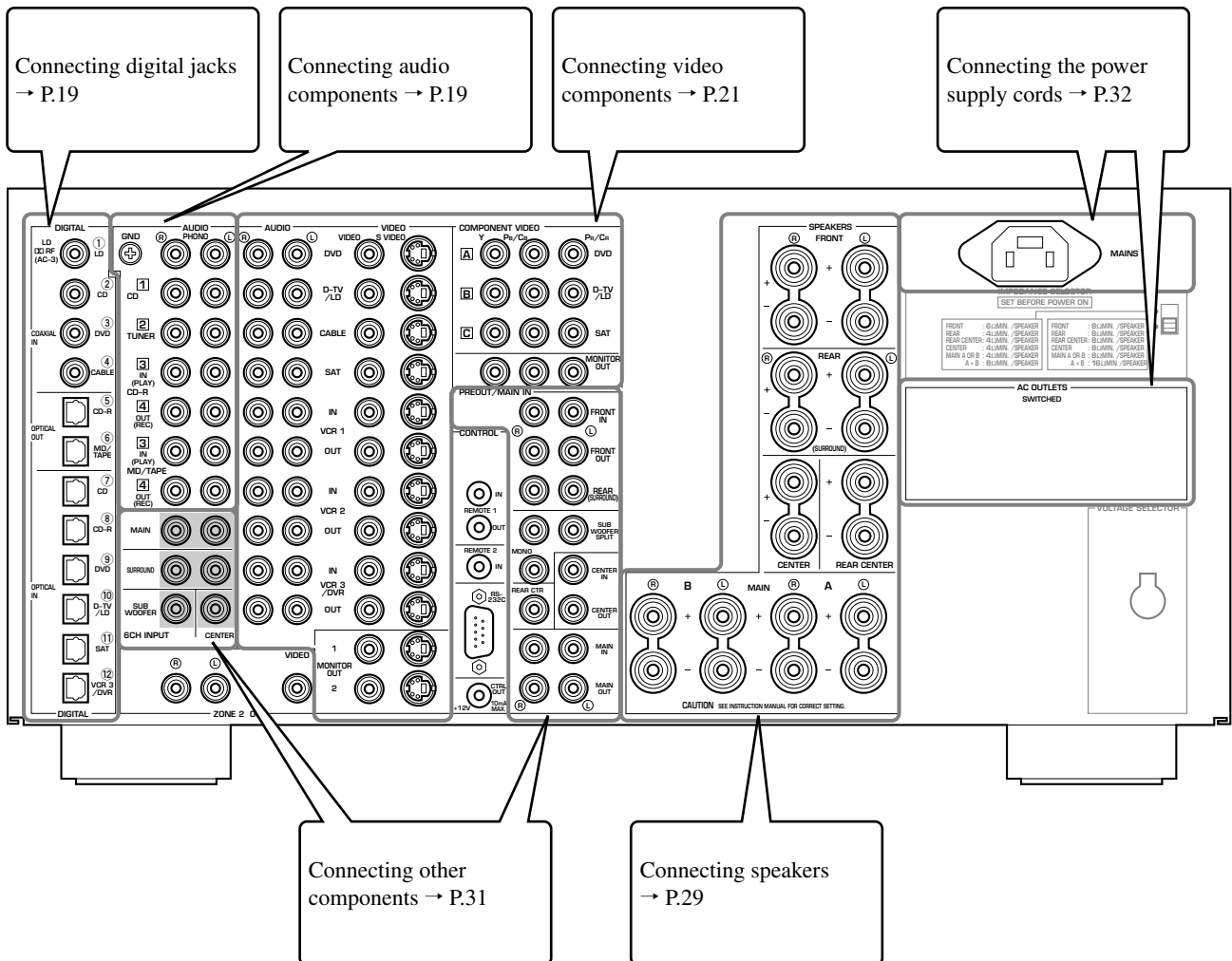

Connecting digital jacks

This unit has digital jacks for direct transmission of digital signals through either coaxial or fiber optic cables.

Notes

- **DIGITAL OUTPUT** jacks and analog **OUT (REC)** jacks are independent. Only digital signals are output from **DIGITAL OUTPUT** jacks and analog signals from **OUT (REC)** jacks.
- You can use the digital jacks to input PCM, Dolby Digital and DTS bitstreams.
- When you connect components to both the **COAXIAL** and **OPTICAL** jacks, priority is given to the input signals from the **COAXIAL** jack.
- The **OPTICAL** jacks on this unit conform to the EIA standard. If you use a fiber optic cable that does not conform to this standard, this unit may not function properly.
- You can designate the input for each digital jacks according to your component by using “8 I/O ASSIGNMENT” on the SET MENU (see page 58 for details).

Digital input jacks of this unit support the following sampling frequency.

- **32 kHz**
- **44.1 kHz:** CD, CD-R and MD
- **48 kHz:** DVD (48 kHz mode)
- **96 kHz:** DVD (96 kHz mode)
- **192 kHz (coaxial input only):** DVD audio (2-channel)

Connecting audio components

Before you connect any components, disconnect the power supply to all the components you plan to connect including this unit and determine which jacks are for the left and right channels and for input and output.

When you connect other YAMAHA audio component (such as a CD player or changer, MD deck, or tape deck), connect to terminals with the same number labels. Yamaha applies this labelling system to all its products.

■ Connecting an FM/AM tuner

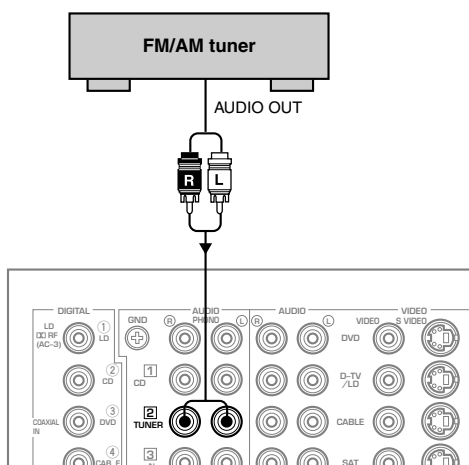

■ Connecting a CD recorder

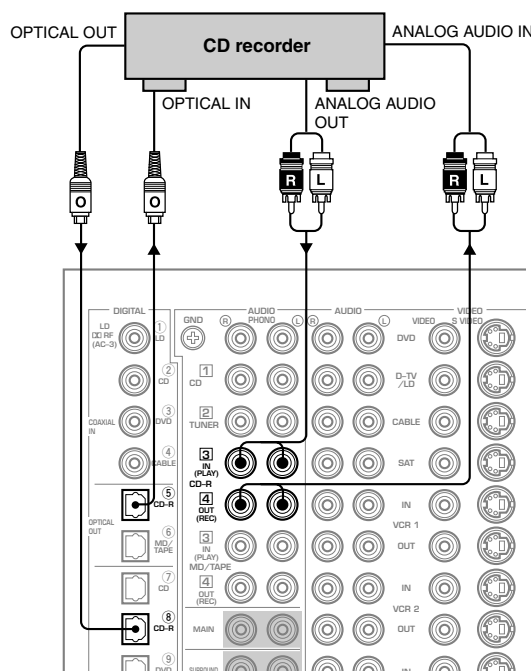

CONNECTIONS

■ Connecting a CD player

The **COAXIAL CD** and **OPTICAL CD** jacks are available for a CD player which has coaxial or optical digital outputs.

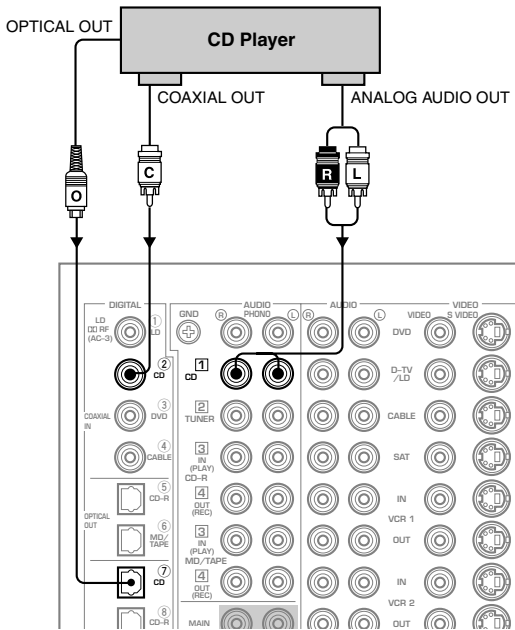

■ Connecting a turntable

These jacks are for connecting a turntable with an MM or high output MC cartridge. If you have a turntable with a low output MC cartridge, use an inline boosting transformer or MC-head amplifier when connecting to these jacks.

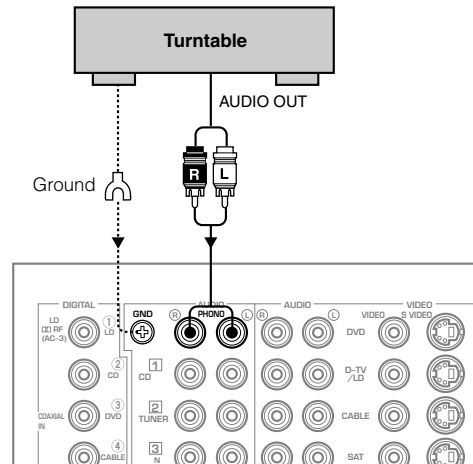

Caution

- The **GND** terminal does not electrically ground the turntable. It simply reduces noise in the signal. In some cases, you may hear less noise if you do not connect to the **GND** terminal.

■ Connecting an MD recorder/tape deck

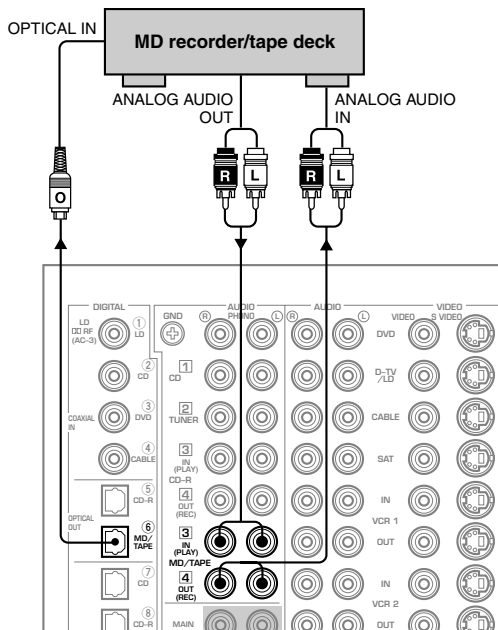

Note

- To connect the **OPTICAL (COAXIAL)** output jack for an MD recorder with this unit, you can use any of the **OPTICAL (COAXIAL) IN** jacks by changing the setting for "8 I/O ASSIGNMENT" on the SET MENU.

Connecting video components

Before you connect any components, disconnect the power supply to all the components you plan to connect including this unit and determine which jacks are for the left and right channels and for input and output. After you finish all connections, check them again to make sure they are correct.

About the video jacks

There are three types of video jacks.

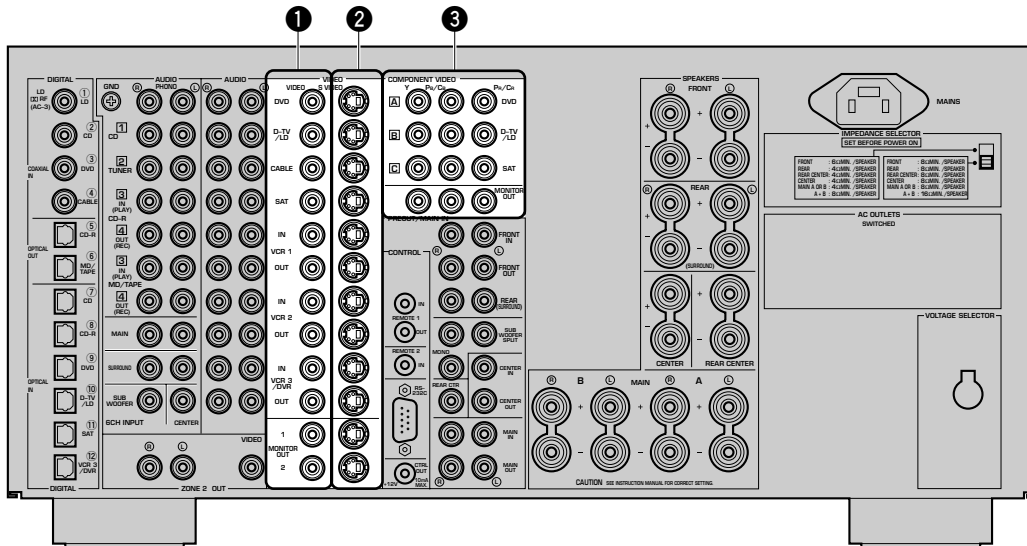

1 Composite VIDEO jack

Video signals input through the **VIDEO** jacks are the conventional composite video signals.

2 S VIDEO jack

Video signals input through the **S VIDEO** jacks are separated into luminance (Y) and color (C) video signals. The S-video signals achieve high quality color reproduction. When you are using the **S VIDEO** jacks, check the details in the owner's manual that came with the component being connected.

3 COMPONENT VIDEO jacks

Video signals input through the **COMPONENT VIDEO** jacks are separated into luminance (Y) and color difference (Pb/Cb, Pr/Cr) video signals. The jacks are also separated into three for each signal. The labels of the component video jacks may be different depending on the component (e.g. Y, Cb, Cr / Y, Pb, Pr / Y, B-Y, R-Y / etc.). Component video signals provide the best quality in picture reproduction. When you are using the **COMPONENT VIDEO** jacks, check the details in the owner's manual that came with the component being connected.

Cautions

- Use a commercially available S-video cable when connecting to the **S VIDEO** jacks, and commercially available video cables when connecting to the **COMPONENT VIDEO** jacks.
- Each type of video jack works independently. Signals input through the composite video, S-video, and component jacks are output through the corresponding composite video, S-video, and component jacks respectively.
- If your video monitor is connected only to the **COMPONENT VIDEO** jacks of this unit, the OSD is not shown.

Note

- You can designate the input for the **COMPONENT VIDEO A, B** and **C** jacks according to your component by using "8 I/O ASSIGNMENT" on the SET MENU (see page 58 for details).

CONNECTIONS

■ Connecting a DVD player

- Connect the left and right analog signal output jacks on your DVD player to the **DVD L** and **R** jacks. Connect the composite video signal output jack on your DVD player to the **DVD VIDEO** jack.
- If your DVD player has an S-video output or component video output, you can connect it to this unit. Connect the S-video signal output jack on your DVD player to the **DVD S VIDEO** jack or connect the component video signal output jacks on your DVD player to the **DVD COMPONENT VIDEO** jacks.
- Connect the optical digital signal output jack on your DVD player to the **OPTICAL DVD** jack.
- Connect the coaxial digital signal output jack on your DVD player to the **COAXIAL DVD** jack.

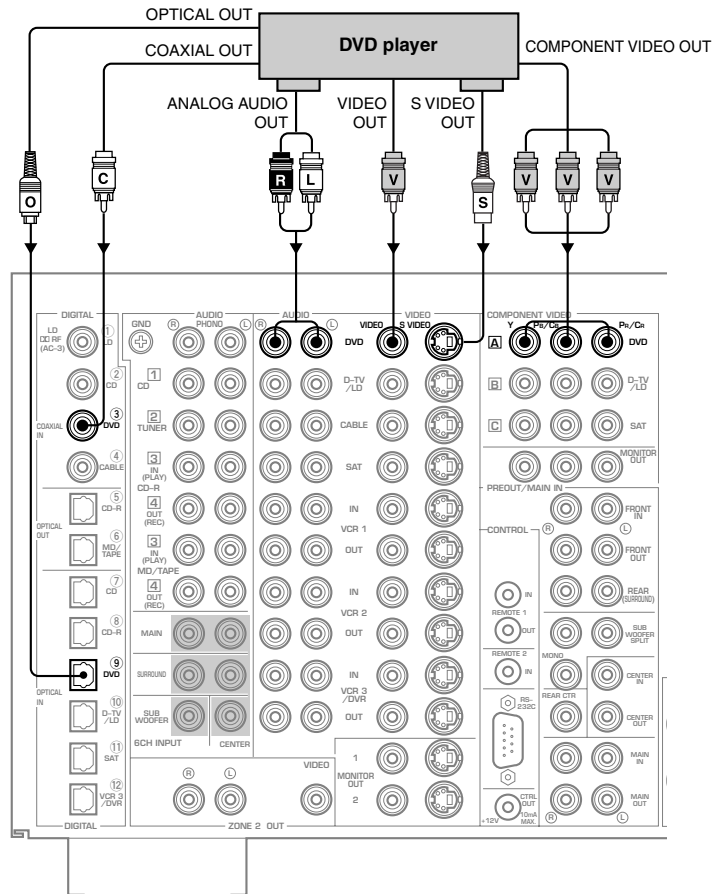

■ Connecting a digital TV/TV

- Connect the left and right analog signal output jacks on your digital TV/TV to the **D-TV/LD** (L) and (R) jacks. Connect the composite video signal output jack on your digital TV/TV to the **D-TV/LD VIDEO** jack.
- If your digital TV/TV has an S-video output or component video output, you can connect it to this unit. Connect the S-video signal output jack on your digital TV/TV to the **D-TV/LD S VIDEO** jack or connect the component video signal output jacks on your digital TV/TV to the **D-TV/LD COMPONENT VIDEO** jacks.
- Connect the optical digital signal output jack on your digital TV/TV to the **OPTICAL D-TV/LD** jack.

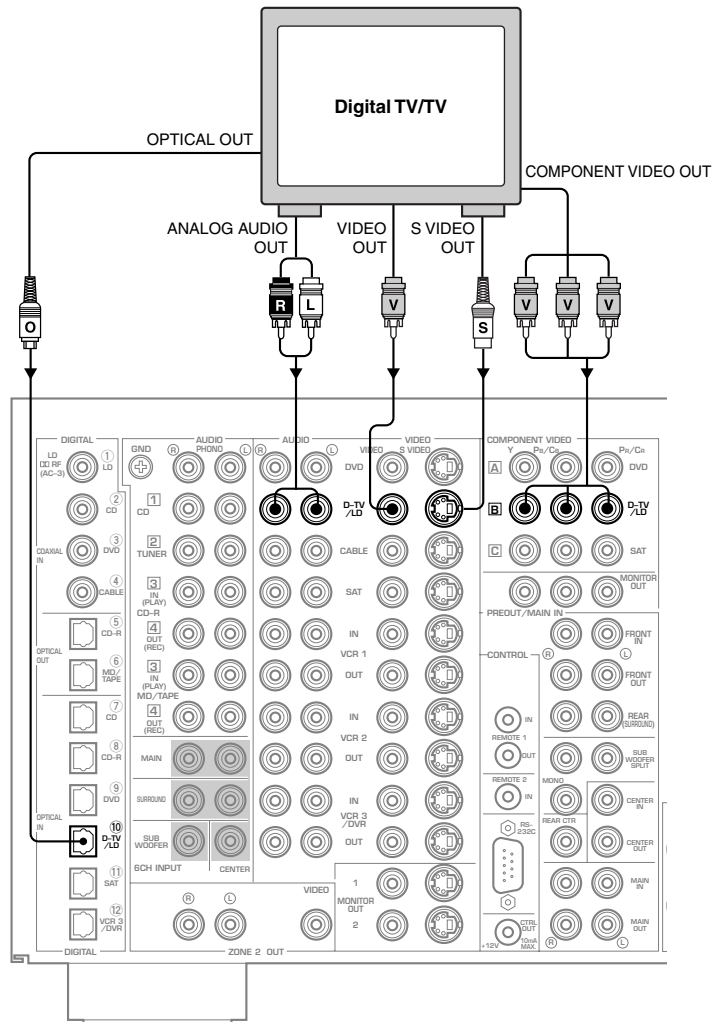

PREPARATIONS

English

■ Connecting a cable TV tuner

- Connect the left and right analog signal output jacks on your cable TV tuner to the **CABLE** (L) and (R) jacks. Connect the composite video signal output jack on your cable TV tuner to the **CABLE VIDEO** jack.
- If your cable TV tuner has an S-video output or component video output, you can connect it to this unit. Connect the S-video signal output jack on your cable TV tuner to the **CABLE S VIDEO** jack or connect the component video signal output jacks on your cable TV tuner to the **SAT COMPONENT VIDEO** jacks.
- Connect the optical digital signal output jack on your cable TV tuner to the **OPTICAL SAT** jack.
- Connect the coaxial digital signal output jack on your cable TV tuner to the **COAXIAL CABLE** jack.

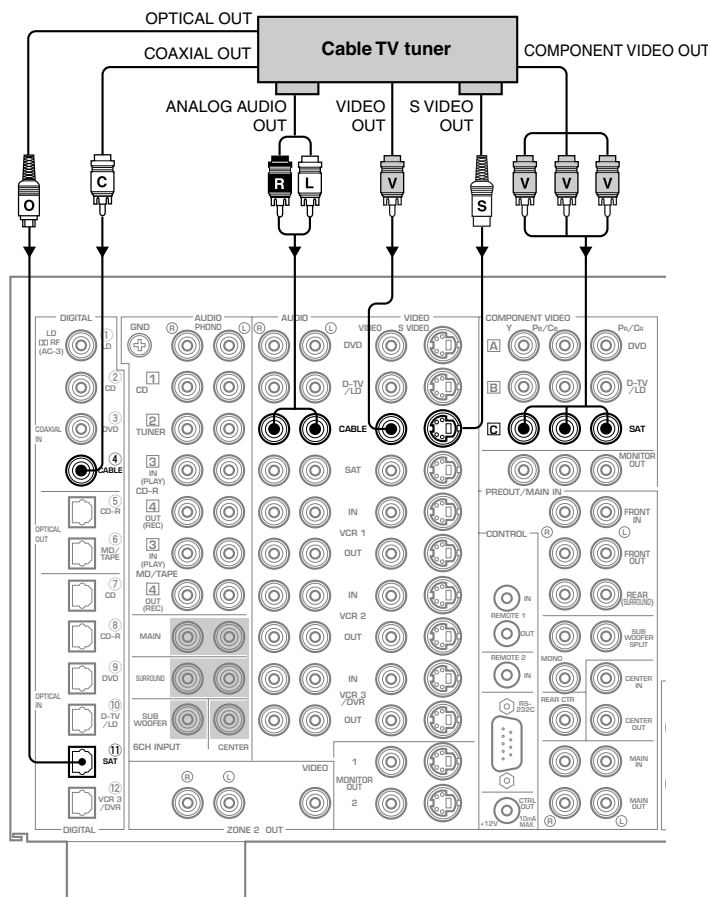

Cautions

- When connecting the optical digital signal output jack on your cable TV tuner, it is necessary to change the setting for the **OPTICAL SAT** jack of “8 I/O ASSIGNMENT” on the SET MENU in order to connect the digital audio signals to the **SAT** jack and the video signals to **CABLE** jack. (See page 58.)
- When connecting the component video signal output jacks on your cable TV tuner, it is necessary to change the setting for **SAT COMPONENT VIDEO** jacks of “8 I/O ASSIGNMENT” on the SET MENU in order to connect the audio signals to the **CABLE** jack and the component video signal to the **SAT** jack. (See page 58.)

■ Connecting a satellite tuner

- Connect the left and right analog signal output jacks on your satellite tuner to the **SAT L** and **R** jacks. Connect the composite video signal output jack on your satellite tuner to the **SAT VIDEO** jack.
- If your satellite tuner has an S-video output or component video output, you can connect it to this unit. Connect the S-video signal output jack on your satellite tuner to the **SAT S VIDEO** jack or connect the component video signal output jacks on your satellite tuner to the **SAT COMPONENT VIDEO** jacks.
- Connect the optical digital signal output jack on your satellite tuner to the **OPTICAL SAT** jack.
- Connect the coaxial digital signal output jack on your satellite tuner to the **COAXIAL CABLE** jack.

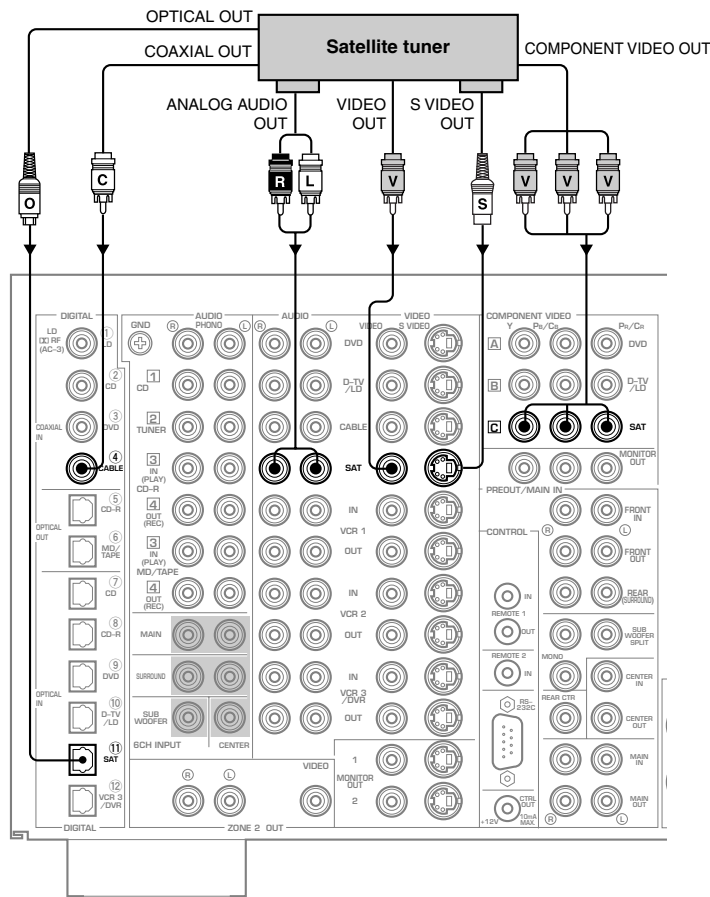

Caution

- When connecting the coaxial digital signal output jack on your satellite tuner, it is necessary to change the setting for the **COAXIAL CABLE** jack of "8 I/O ASSIGNMENT" on the SET MENU in order to connect the digital audio signals to the **CABLE** jack and the video signals to **SAT** jack. (See page 58.)

PREPARATIONS

English

■ Connecting a VCR

- Connect the left and right audio signal output jacks on your VCR to the **VCR 1 IN** (L) and (R) jacks. Connect the left and right audio signal input jacks on your VCR to the **VCR 1 OUT** (L) and (R) jacks. Connect the composite video signal output jack on your VCR to the **VCR 1 VIDEO IN** jack. Connect the composite video signal input jack on your VCR to the **VCR 1 VIDEO OUT** jack.
- If your VCR has an S-video output, you can connect it to this unit. Connect the S-video signal output jack on your VCR to the **VCR 1 IN S VIDEO** jack. If your VCR has an S-video input, you can connect it to this unit. Connect the S-video signal input jack on your VCR to the **VCR 1 OUT S VIDEO** jack.
- If your VCR has an optical digital signal output jack, connect it to the **OPTICAL VCR 3/DVR** jack.

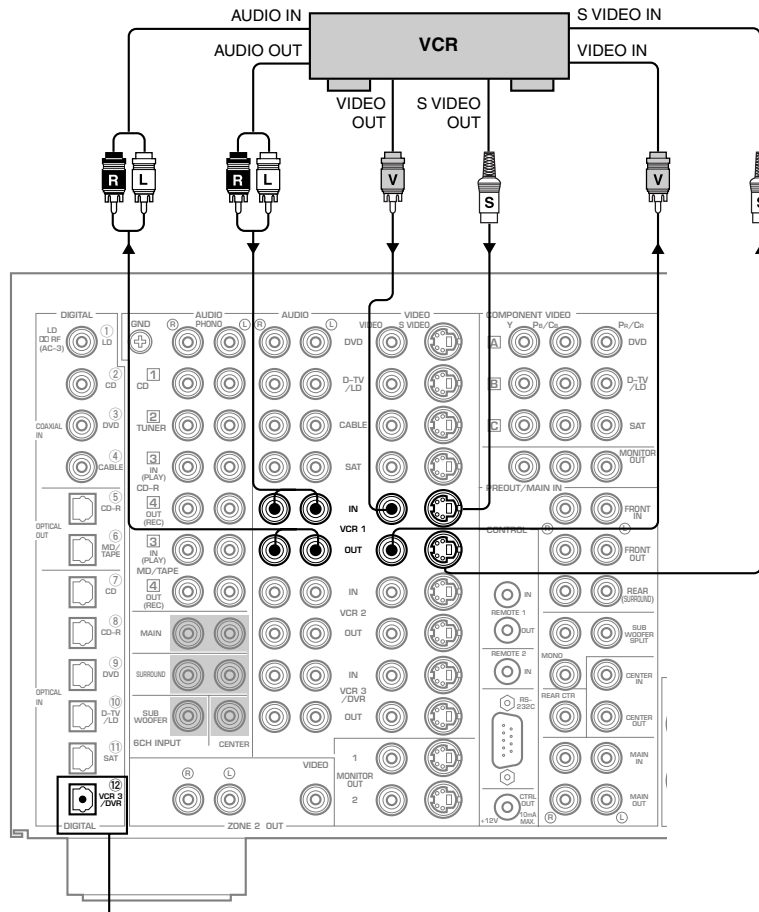

This jack is for connecting with the component that has an optical digital output jack such as a DVD recorder.

Note

- You can connect other VCRs to this unit using the **VCR 2** and **VCR 3/DVR** jacks.

■ Connecting an LD player

- Connect the left and right audio signal output jacks on your LD player to the **D-TV/LD** (L) and (R) jacks. Connect the composite video signal output jack on your LD player to the **D-TV/LD VIDEO** jack.
- If your LD player has an S-video output, you can connect it to this unit. Connect the S-video signal output jack on your LD player to the **D-TV/LD S VIDEO** jack.
- Connect the optical digital signal output jack on your LD player to the **OPTICAL D-TV/LD** jack.
- Connect the RF signal output jack on your LD player to the **LD RF (AC-3)** jack.

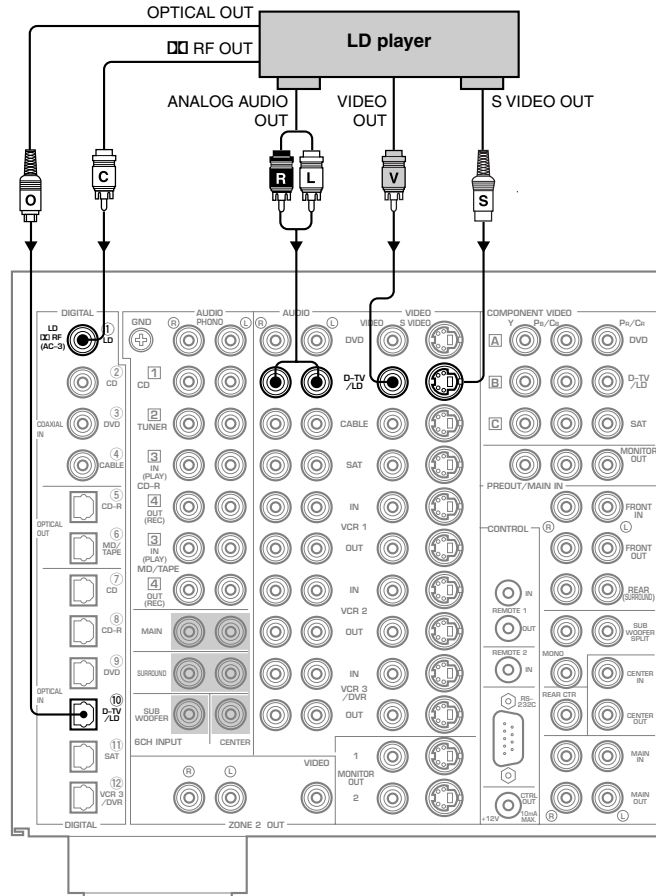

PREPARATIONS

English

CONNECTIONS

■ Connecting a video monitor

- Connect the composite video signal input jack on your video monitor to **MONITOR OUT 1 VIDEO** jack.
- If your video monitor has an S-video input or component video input, you can connect it to this unit. Connect the S-video signal input jack on your video monitor to the **MONITOR OUT 1 S VIDEO** jack or connect the component video signal input jacks on your video monitor to the **COMPONENT VIDEO MONITOR OUT** jacks.

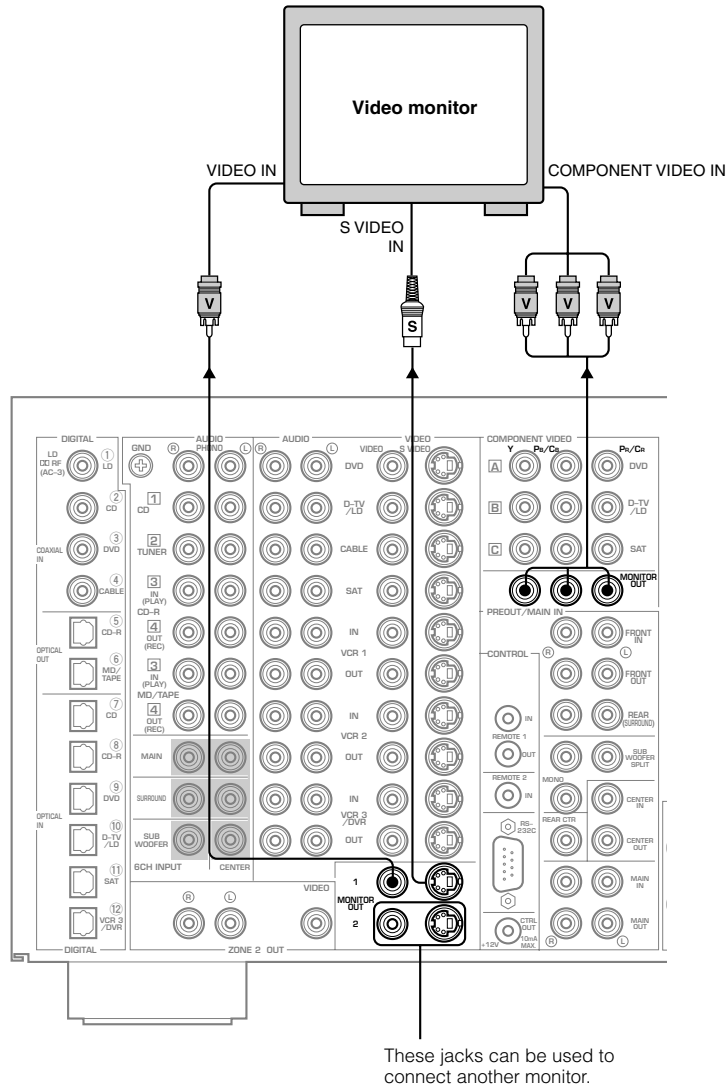

Note

- You can connect another monitor to this unit using the **MONITOR OUT 2** jacks.

Connecting speakers

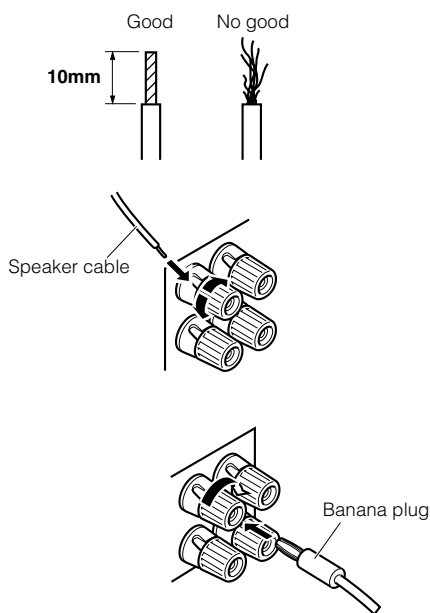
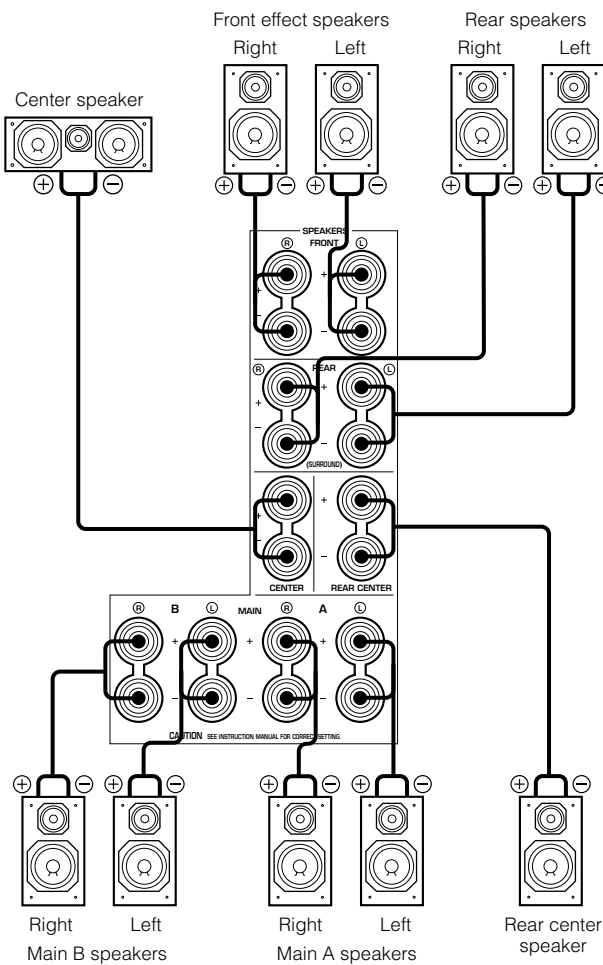

- Be sure to connect the left channel (L), right channel (R), “+” (red) and “-” (black) properly. If the connections are faulty, no sound will be heard from the speakers, and if the polarity of the speaker connections is incorrect, the sound will be unnatural and lack bass.
- Connect the speaker cables with care to avoid creating a short circuit. If you turn on the power and there is a short circuit, this unit may be damaged even though the protection circuit automatically shuts off the power.

After you finish connecting your speakers, use the SET MENU to change the signal output settings according to the number and size of the speakers in your configuration.

■ Connecting the SPEAKERS terminals

A speaker cable is actually a pair of insulated cables running side by side. One of the cables is colored or shaped differently, perhaps with a stripe, groove or ridge.

- 1 Strip off 10 mm (3/8”) of insulation from the ends of the cables.
- 2 Twist the exposed wires of the cable together to prevent short circuits.
- 3 Loosen the terminal knob by turning it counterclockwise.
- 4 Insert only the exposed portion of the cable into the slot in the side of the terminal, and tighten the terminal knob.

Note

- If your speaker cables have banana plugs, tighten the terminal knob and insert the plug into the end of the terminal. (Except for Europe and U.K. models)

CONNECTIONS

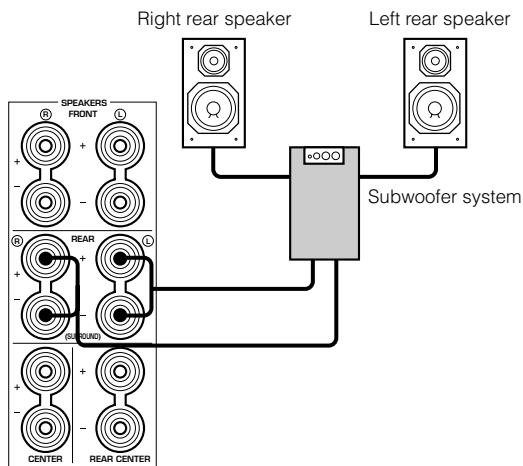
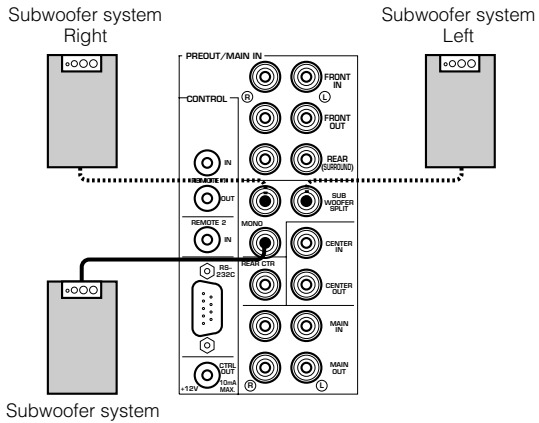

WARNING

Do not change the **IMPEDANCE SELECTOR** switch setting while the power to this unit is on, otherwise this unit may be damaged.

IF THIS UNIT FAILS TO TURN ON WHEN THE **STANDBY/ON SWITCH IS PRESSED:**

The **IMPEDANCE SELECTOR** switch may not be set to either end. If so, set the switch to either end when this unit is in the standby mode.

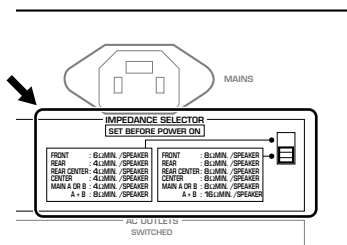

■ Connecting a front subwoofer

Connect the signal input jack on your subwoofer to the **PREOUT/MAIN IN SUBWOOFER MONO** jack.

By connecting two subwoofers to the **SUBWOOFER SPLIT** jacks, this unit can reproduce subtle directional changes in the low frequency sounds.

When you use two subwoofers, connect both of them to the **SUBWOOFER SPLIT** jacks using pin plugs.

■ Connecting a rear subwoofer

By using both front and rear subwoofers, the CINEMA-DSP sound field programs can produce realistic movie effects with powerful, dynamic sound. To take advantage of this dynamic sound, be sure to set the "1C REAR L/R SP" item in the SET MENU to "LARGE" (see page 36).

Caution

- Adjust the speaker volume for the subwoofer with the controls on the subwoofers, not on this unit.

■ Impedance selector switch

Select the position whose requirements your speaker system meets.

 (Upper position)

Front effect: The impedance of each speaker must be 6Ω or higher.

Rear: The impedance of each speaker must be 4Ω or higher.

Rear Center: The impedance of the speaker must be 4Ω or higher.

Center: The impedance of the speaker must be 4Ω or higher.

Main: If you use one pair of main speakers, the impedance of each speaker must be 4Ω or higher. If you use two pairs of main speakers, the impedance of each speaker must be 8Ω or higher.

 (Lower position)

Front effect: The impedance of each speaker must be 8Ω or higher.

Rear: The impedance of each speaker must be 8Ω or higher.

Rear Center: The impedance of the speaker must be 8Ω or higher.

Center: The impedance of the speaker must be 8Ω or higher.

Main: If you use one pair of main speakers, the impedance of each speaker must be 8Ω or higher. If you use two pairs of main speakers, the impedance of each speaker must be 16Ω or higher.

Connecting other components

■ Connecting external amplifiers

If you want to increase the power output to the speakers, or want to use another amplifier, connect an external amplifier to the **PREOUT/MAIN IN** terminals as follows.

Caution

- When an RCA pin-plug cable is connected to the **PREOUT** jack in order to output to the external amplifier, do not connect speakers to this unit. If you do, the sound will be output from both speakers connected to the external amplifier and this unit.

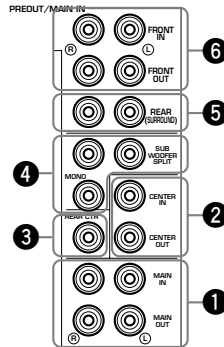

1 MAIN jacks

MAIN OUT jacks

Main channel line output jacks. The signals output through these jacks are affected by **VOLUME**, **BASS**, **TREBLE**, and **BASS EXTENSION** settings.

MAIN IN jacks

Line input to this unit's main channel amplifiers. When connecting to these jacks, signals input to the preamplifier of this unit will not be output from the main amplifier of this unit.

2 CENTER jacks

CENTER OUT jack

Center channel line output jacks.

CENTER IN jack

Line input to this unit's center channel amplifier. When connecting to these jacks, signals input to the preamplifier of this unit will not be output from the center amplifier of this unit.

3 REAR CTR jack

Rear center channel line output jack.

4 SUBWOOFER jacks

Subwoofers reinforce very low frequencies.

MONO

Main, center and rear channel frequencies below 90 Hz are output through this jack. You can also direct DTS and Dolby Digital LFE signals to this output.

SPLIT

The **SPLIT** jacks output stereo separation for the main and rear channels and a split mono signal for the center and LFE channels.

Adjust the volume level of the subwoofer with the control on the subwoofer. Depending on the settings in SET MENU item "1 SPEAKER SET", some signals may not be output from the **SUBWOOFER** jacks.

5 REAR (SURROUND) jacks

Rear channel line output jacks.

6 FRONT jacks

FRONT OUT jacks

Front effect channel line output jacks.

FRONT IN jacks

Line input to this unit's front effect channel amplifiers. When connecting to these jacks, signals input to the preamplifier of this unit will not be output from the front effect amplifier of this unit.

CONNECTIONS

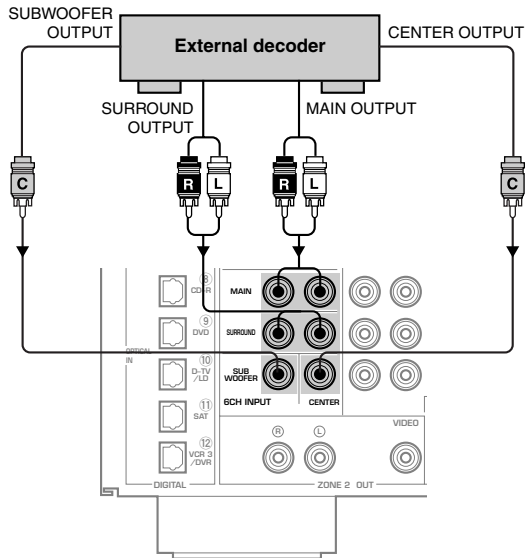

■ Connecting an external decoder

This unit is equipped with six additional input jacks (left and right **MAIN**, **CENTER**, left and right **SURROUND** and **SUBWOOFER**) for discrete multi-channel input from an external decoder, sound processor, or pre-amplifier. Connect the output jacks on your external decoder to the **6CH INPUT** jacks.

Notes

- When you select “6CH INPUT” as the input source, this unit automatically turns off the digital sound field processor, and you cannot listen to DSP programs.
- When you select “6CH INPUT” as the input source, settings of “1 SPEAKER SET” on the SET MENU do not apply (except for “1G MAIN LEVEL”).

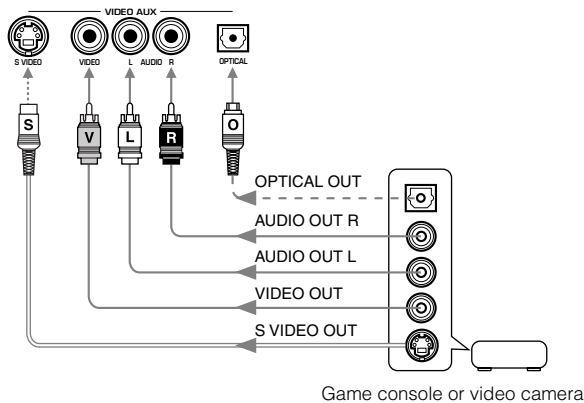

■ Connecting a game console

These jacks are used to connect any video input source such as a game console and a video camera to this unit.

Connecting the power supply cords

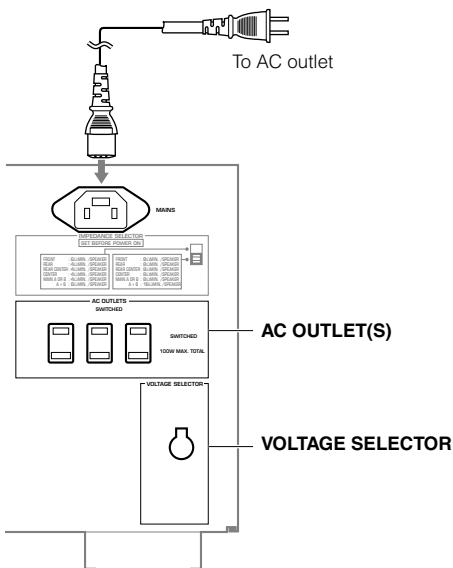

(General and China models)

■ Connecting the AC power cord

Plug the power cord into the AC inlet when all connections are complete, and then plug in the AC power cord to the wall outlet.

Caution

- Do not use other AC power cords than the one provided. Otherwise it may result in causing fire or an electrical shock.

[U.K. model]

Plug in this unit to the wall outlet.

■ AC OUTLET(S)

Europe, General and China models 3 OUTLETS
U.K. model 1 OUTLET

Use these outlets to connect the power cords from your components to this unit. The power to the **AC OUTLET(S)** is controlled by this unit's **STANDBY/ON** (or **SYSTEM POWER** and **STANDBY**). These outlets will supply power to any connected component whenever this unit is turned on. The maximum power (total power consumption of components) that can be connected to the **AC OUTLET(S)** is 100 W.

■ VOLTAGE SELECTOR

(General and China models)

The voltage selector on the rear panel of this unit must be set for your local voltage before plugging into the AC main supply. Voltages are 110/120/220/240 V AC, 50/60 Hz.

ON-SCREEN DISPLAYS (OSD)

You can display the operation information for this unit on a video monitor. If you display the SET MENU and DSP sound field program parameter settings on a screen, it is much easier to see the available options and parameters than it is by reading this information on the front panel display.

Notes

- If a video source is being reproduced, the OSD is superimposed over the image.
- The OSD signal is not output through the **REC OUT** selector, and will not be recorded with any video signal.

OSD modes

You can change the amount of information the OSD shows.

- Full display:** This mode always shows the sound field program parameter settings on the video monitor (see page 95).
- Short display:** This mode briefly shows the same contents as the front panel display at the bottom of the screen, then disappears.
- Display off:** This mode briefly shows the “DISPLAY OFF” message at the bottom of the screen, then disappears. Afterwards, no changes to operations appear on the screen except those of the **ON SCREEN**.

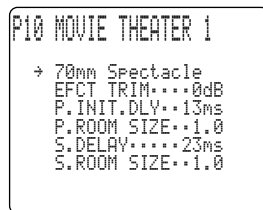

Full display

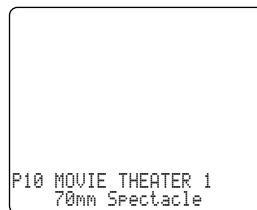

Short display

Notes

- The SET MENU, “TEST DOLBY SUR.” and “TEST DSP” appear regardless of the OSD mode.
- When you choose the Full Display mode, **INPUT SELECTOR**, **VOLUME** and some other types of operation information are displayed at the bottom of the screen in the same format as the front panel display.

Selecting the OSD mode

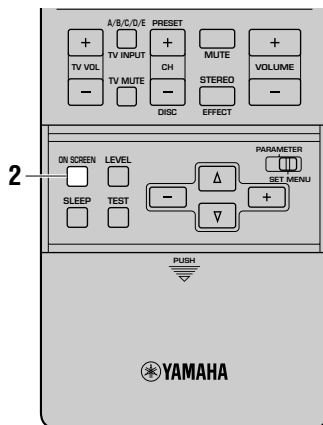

- 1 Turn on the video monitor connected to this unit.
- 2 Press **ON SCREEN** on the remote control repeatedly to change the display mode.

The OSD mode changes in the following order: full display, short display, and display off.

Cautions

- If your video monitor is connected only to the **COMPONENT VIDEO** terminals of this unit, the OSD is not shown.
- If you choose a video input source that has component connected to both the **S VIDEO IN** and composite **VIDEO IN** jacks, and both the **S VIDEO OUT** and composite **VIDEO OUT** jacks are connected to a video monitor, the video signal is output to both the **S VIDEO OUT** and **VIDEO OUT** jacks. However, the OSD is carried only on the S-video signal. If no video signal is input, the OSD is carried on both the S-video and composite video signals.
- Playing back video software that has an anti-copy signal or video signals with a lot of noise may produce unstable images.

SPEAKER MODE SETTINGS

This unit has seven SPEAKER SET items in the SET MENU that you must set according to the number of speakers in your configuration and their size. The following table summarizes these SPEAKER SET items, and shows the initial settings as well as other possible settings. If the initial settings are not appropriate for your speaker configuration, change the settings in the SET MENU.

Summary of SPEAKER SET items 1A through 1G

Item	Description	Control value (default setting indicated in bold)
1A CENTER SP	Selects the output mode according to whether or not a center speaker is being used and its performance.	LRG /SML/NONE
1B MAIN SP	Selects the output mode according to the performance of the main speakers.	LARGE /SMALL
1C REAR L/R SP	Selects the output mode according to whether or not rear L/R speakers are being used and their performance.	LRG /SML/NONE
1D REAR CT SP	Selects the output mode according to whether or not a rear center speaker is being used and its performance.	LRG /SML/NONE
1E LFE/BASS OUT	Selects the speaker according to use for LFE signal output and low bass signal.	SW/ MAIN /BOTH
1F FRONT EFCT SP	Selects the output mode according to whether or not front effect speakers are being used.	YES /NONE
1G MAIN LEVEL	Selects the main speaker level.	Normal /-10dB

Cautions

- When you select **6CH INPUT** as the input source, settings of “1 SPEAKER SET” on the SET MENU do not apply (except for “1G MAIN LEVEL”).
- When the digital signals with over 96 kHz sampling frequency are input, only the “1G MAIN LEVEL” setting is effective.

Mode setting

Adjustment should be made with the remote control.

1 Set PARAMETER/SET MENU to SET MENU.

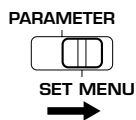

2 Select “1 SPEAKER SET” on the SET MENU.

Press Δ/∇ on the remote control to display the SET MENU on the monitor. Press Δ/∇ repeatedly to select “1 SPEAKER SET” on the SET MENU.

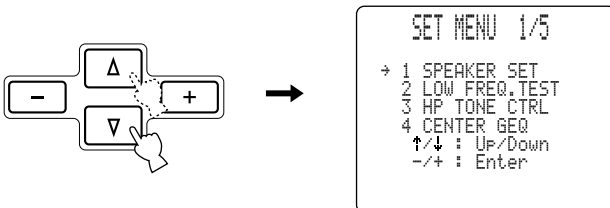

3 Enter the setting mode.

Press $+/-$ on the remote control to enter the setting mode. The current setting is shown on the front panel display and the video monitor. Select the item (1A – 1G) to be set by pressing Δ/∇ on the remote control.

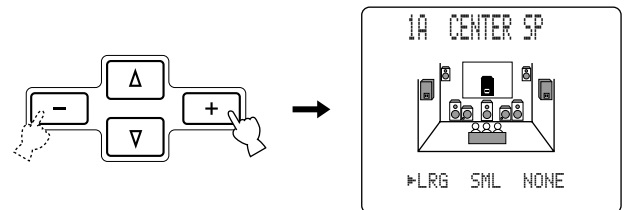

4 Change the setting.

Press $+/-$ on the remote control repeatedly to change the setting for the selected item.

5 Close the SET MENU.

Press Δ/∇ repeatedly until the DSP program name appears to close SET MENU or press one of the DSP program buttons on the remote control.

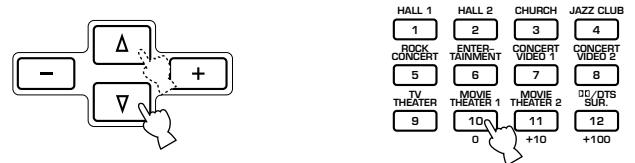

Note

- This setting operation can be done by using **NEXT** and **SET MENU +/-** on the front panel.

■ 1A CENTER SP (center speaker mode)

By adding a center speaker to your speaker configuration, this unit can provide good dialogue localization for many listeners and superior synchronization of sound and images. The OSD shows a large, small, or no center speaker depending on how you set this item. The initial setting is "LRG".

- LRG:** Select the "LRG" (Large) setting if you have a large center speaker. The entire range of center channel signals is sent to the center speaker.
- SML:** Select the "SML" (Small) setting if you have a small center speaker. Center channel low frequency signals of 90 Hz and below are directed to the speakers selected with the "1E LFE/BASS OUT" item.
- NONE:** Select the "NONE" setting if you do not have a center speaker. All of the center channel signals are directed to the left and right main speakers.



■ 1B MAIN SP (main speaker mode)

The display shows small or large main speakers depending on how you set this item. The initial setting is "LARGE".

- LARGE:** Select the "LARGE" setting if you have large main speakers. The entire range of left and right main channel signals is directed to the left and right main speakers.
- SMALL:** Select the "SMALL" setting if you have small main speakers. The main channel low frequency signals of 90 Hz and below are directed to the speakers selected with the "1E LFE/BASS OUT" item.

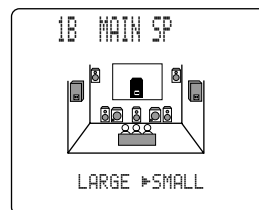
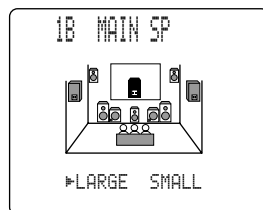

Caution

- When you select the "MAIN" setting for the "1E LFE/BASS OUT" item, the main channel low frequency signals of 90 Hz and below are directed to the main speakers even if you select the "SMALL" setting for the main speaker mode.

SPEAKER MODE SETTINGS

■ 1C REAR L/R SP (rear speaker mode)

The OSD shows large, small, or no rear speakers depending on how you set this item. The initial setting is “LRG”.

- LRG:** Select the “LRG” setting if you have large left and right rear speakers or if you use a rear subwoofer. The entire range of rear channel signals is sent to the left and right rear speakers.
- SML:** Select the “SML” setting if you have small left and right rear speakers. Rear channel low frequency signals of 90 Hz and below are directed to the speakers selected with the “1E LFE/BASS OUT” item.
- NONE:** Select the “NONE” setting if you do not have rear speakers. All of the rear channel signals are directed to the left and right main speakers.

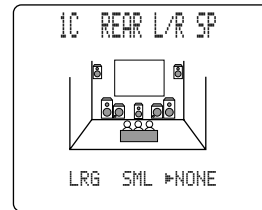

Caution

- In this case, the rear center speaker will automatically be set to “NONE” and the “1D REAR CT SP” item will be skipped.

■ 1D REAR CT SP (rear center speaker mode)

By adding a rear center speaker to your speaker configuration, this unit can provide more realistic front-to-back and back-to-front transitions. The initial setting is “LRG”.

- LRG:** Select the “LRG” setting if you have a large rear center speaker. The entire range of rear center channel signals is sent to the rear center speakers.
- SML:** Select the “SML” (small) setting if you have a small rear center speaker. Rear center channel low frequency signals of 90 Hz and below are distributed to speakers selected with the “1E LFE/BASS OUT” item.
- NONE:** Select the “NONE” setting if you do not have a rear center speaker. The rear center signal is directed to the rear L/R speakers.

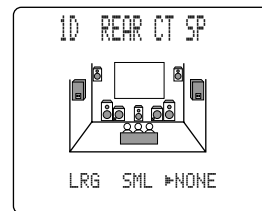
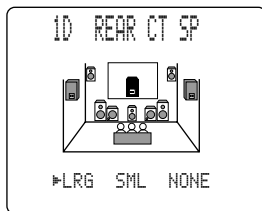

Caution

- If “1C REAR L/R SP” is set to “NONE”, “1D REAR CT SP” will be skipped from the SET MENU and the setting cannot be changed.

■ 1E LFE/BASS OUT (bass output mode)

LFE signals carry low frequency effects when this unit decodes DTS or Dolby Digital signals. Low frequency signals are defined as 90 Hz and below. The initial setting is “BOTH”.

- SW:** Select the “SW” (subwoofer) setting if you use a subwoofer. The LFE signals are directed to the subwoofer.
- MAIN:** Select the “MAIN” setting if you do not use a subwoofer. The LFE signals are directed to the main speakers.
- BOTH:** Select the “BOTH” setting if you use a subwoofer and you want to mix the main channel low frequency sound signals with the LFE signals.

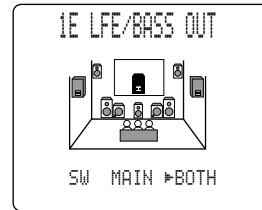
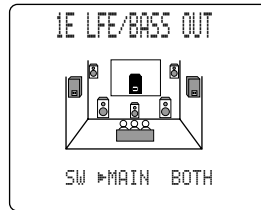
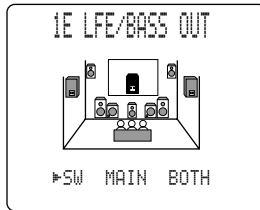

Caution

- The low frequency signals of 90 Hz and below from all main, center, rear, and rear center channels are directed to the LFE channel when you select the small speaker setting in items 1A, 1B, 1C, and 1D.

■ 1F FRONT EFCT SP (front effect speaker mode)

This unit uses front effect speakers to localize the virtual sound sources of the sound field programs. If you do not use front effect speakers, you can direct the front effect signals to the main speakers.

The OSD shows small or no front effect speakers depending on how you set this item. The initial setting is “YES”.

- YES:** Select the “YES” setting if you use front effect speakers.
- NONE:** Select the “NONE” setting if you do not use front effect speakers. The front effect signals are mixed with the main channels.

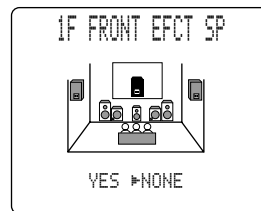
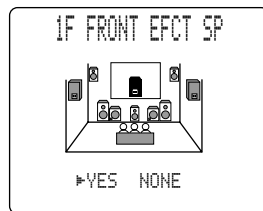

■ 1G MAIN LEVEL

Change this setting if you cannot match the sound volume of the front effect, rear, center, and rear center speakers with the main speakers because of the unusually high efficiency performance of the main speakers. The initial setting is “Normal”.

- Normal:** Select the “Normal” setting if you can match the volume of your effect speakers with the volume of your main speakers using the “TEST DOLBY SUR.”.
- 10dB:** Select the “-10dB” setting if you cannot match the volume of your effect speakers with the volume of your main speakers using the “TEST DOLBY SUR.”.

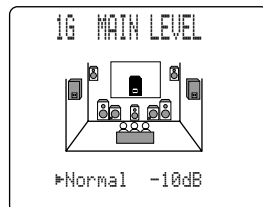

SPEAKER OUTPUT LEVELS

This section explains how to set the speaker output levels using the test tone generator. The “TEST DOLBY SUR.” is for balancing the output levels of the six speakers required for surround sound systems. The “TEST DSP” is for balancing the front effect speakers with the main speakers for the DSP sound field programs.

■ Button/switch to be used for adjustment

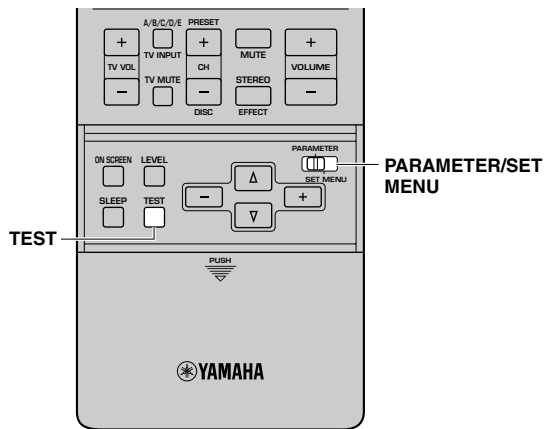

■ Before you begin

- 1 Set **BASS**, **TREBLE** and **BALANCE** on the front panel to the center position.

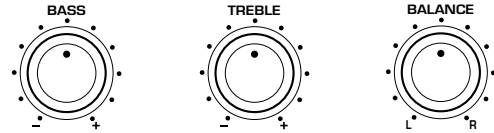

- 2 Turn off **BASS EXTENSION**.



- 3 Set **PARAMETER/SET MENU** on the remote control to **PARAMETER**.

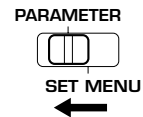

Cautions

- Since this unit cannot enter the test mode while headphones are connected to this unit, be sure to unplug the headphones from the **PHONES** jack when using the test tone.
- If the headphone is connected while “TEST DOLBY SUR.” or “TEST DSP” is being used, the testing mode will be cancelled.

TEST DOLBY SUR.

Select “TEST DOLBY SUR.” to match the output levels of the center, rear center and left and right rear speakers to the left and right main speakers.

1 Press TEST on the remote control.

“TEST DOLBY SUR.” appears on the video monitor and front panel display.

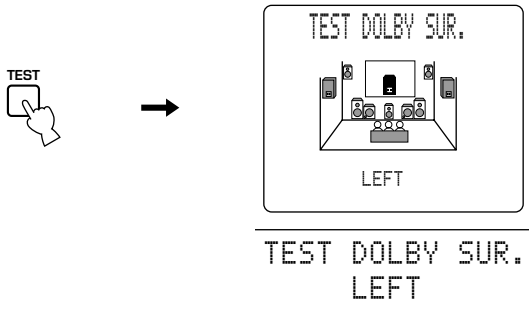

The test tone is produced from the left main speaker, center speaker, right main speaker, right rear speaker, rear center speaker and left rear speaker in order. The tone is produced for 2.5 seconds each time. You can also select the speaker to be adjusted by pressing Δ/∇ .

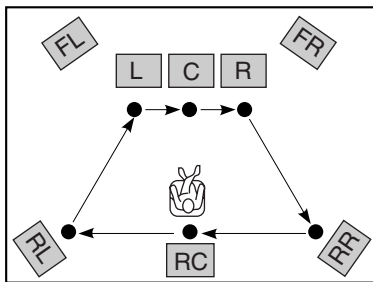

Caution

- Speakers whose settings are set to “NONE” in “1 SPEAKER SET” (except for “1A CENTER SP”) on the SET MENU will be skipped and no test tone will be output.

2 Adjust VOLUME +/- so you can hear the test tone.

Caution

- If the test tone cannot be heard, turn down the volume, set this unit in the standby mode and check the speaker connections.

3 Press +/- repeatedly to adjust the output level of the effect speakers so that the output level coming from each speaker is the same.

Each speaker level can be adjusted in the range of -10 to $+10$ dB.

While adjusting, the test tone is heard from the selected speaker.

Cautions

- If “1A CENTER SP” on the SET MENU is set to “NONE”, the center channel sound is automatically output from the left and right main speakers.
- If “1C REAR L/R SP” on the SET MENU is set to “NONE”, the output level of the rear left, right and center speakers cannot be adjusted in step 3.
- If “1D REAR CT SP” on the SET MENU is set to “NONE”, the output level of the rear center speaker cannot be adjusted in step 3.
- Main L/R speaker level cannot be adjusted by itself. Use **VOLUME** to adjust the main volume.

4 Press TEST to enter the TEST DSP mode.

Press **TEST** again to stop the test tone and the DSP program name appears on the front panel display and the video monitor.

Notes

- The tonal quality of the speakers can be adjusted using the “4 CENTER GEQ”, “5 REAR CT GEQ”, and “6 CINEMA EQ” items in the SET MENU (see pages 55 to 57).
- You can increase the output levels of the effect channels (left rear, right rear, rear center and center) to $+10$ dB. If the output level of the center, rear, and rear center speakers is lower than that from the main speakers even after you have increased the sound volume level of the center, rear, and rear center speakers up to $+10$ dB, set the “1G MAIN LEVEL” item in the SET MENU to “ -10 dB”. Setting the “1G MAIN LEVEL” item to this setting decreases the main speaker volume level to about one-third the normal level. After you set the “1G MAIN LEVEL” item in the SET MENU to “ -10 dB”, adjust the levels for the center, rear, and rear center speakers again.
- The adjustment of output levels of the center speaker, and left and right rear speakers is also effective to the speaker output level during the playback of the source connected to **6CH INPUT** jacks.

TEST DSP

Select “TEST DSP” to match the output levels of the front effect speakers to the main speakers.

Caution

- You cannot enter the TEST DSP mode if “1F FRONT EFCT SP” is set to “NONE”.

1 Press TEST repeatedly.

“TEST DSP” appears on the video monitor and front panel display.

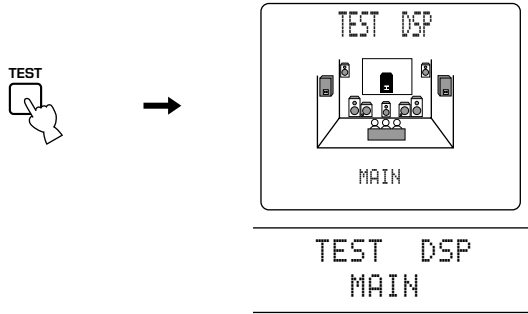

The test tone is produced alternately from the front effect speakers and main speakers. The tone is produced for 2.5 seconds each time. Press Δ to hear the test tone from the front effect L speaker (FRONT L), and ∇ to hear the test tone from the front effect R speaker (FRONT R).

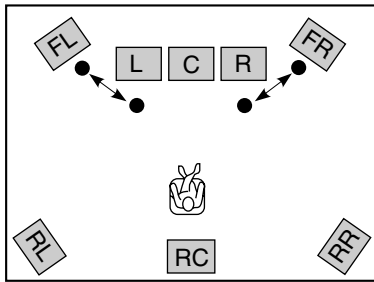

2 Adjust VOLUME +/- so you can hear the test tone.

Caution

- If the test tone cannot be heard, turn down the volume, set this unit in the standby mode and check the speaker connections.

3 Press +/- repeatedly to adjust the output level of the front effect speakers so that the output level coming from each speaker is the same.

The front effect speaker level can be adjusted in the range of -10 to +10 dB. Test tone is output only from the front effect speakers.

Caution

- Main L/R speaker level cannot be adjusted.

4 Press TEST to close TEST DSP.

The test tone stops and the DSP program name appears on the front panel display and the video monitor.

Notes

- The tonal quality of the speakers can be adjusted using the “6 CINEMA EQ” item in the SET MENU (see pages 56 and 57).
- If the sound volume of the front effect speakers is lower than that of the main speakers, even after you have increased the output level up to +10 dB, set the “1G MAIN LEVEL” item in the SET MENU to “-10dB”. Setting the “1G MAIN LEVEL” item to “-10dB” decreases the main speaker output level to about one-third of the normal level. After you set the “1G MAIN LEVEL” item in the SET MENU to “-10dB”, repeat the “TEST DOLBY SUR.” procedure on the previous page.

Basic operations

This section explains the playback operation, DSP program selection and recording operation.

BASIC PLAYBACK	42
Input modes and indications	44
Selecting a sound field program	46
BASIC RECORDING	50

BASIC PLAYBACK

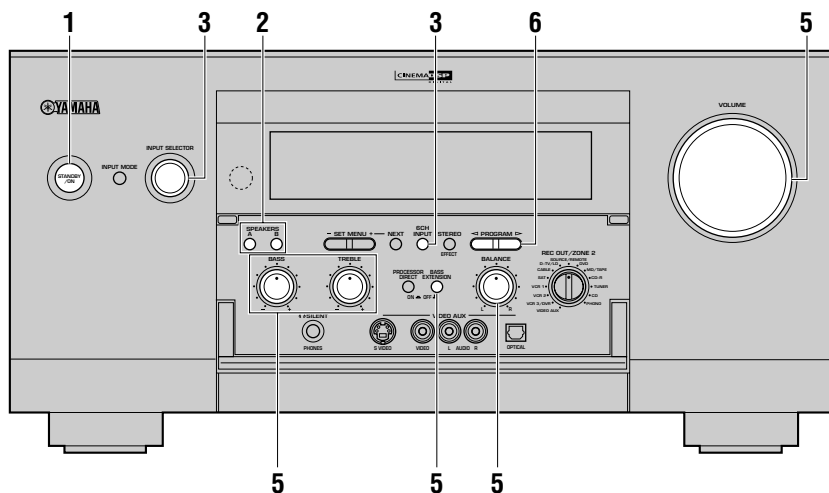
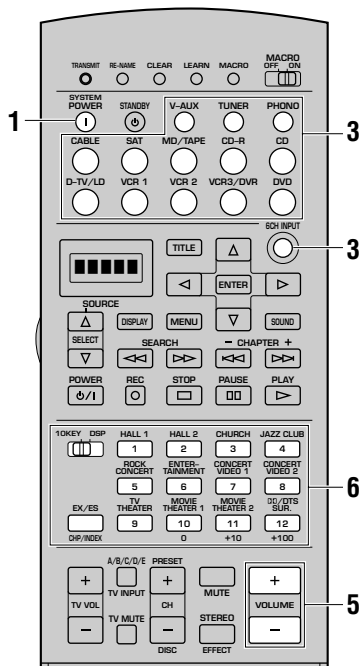

- 1 Press **STANDBY/ON (SYSTEM POWER on the remote control)** to turn on the power.

The front panel (and the monitor screen) shows the level of the volume for a few seconds and then switches to show the current sound field program.



- 2 Press **SPEAKERS A or B** to select the main speakers to be used.

If you are using two sets of main speakers, press both **A** and **B**. The speaker indicator(s) for the selected set(s) lights up on the front panel display.

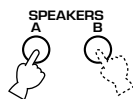

- 3 Select the source using **INPUT SELECTOR**, or press one of the input selector buttons on the remote control.

The current source name and input mode appear on the front panel display and the video monitor for a few seconds.

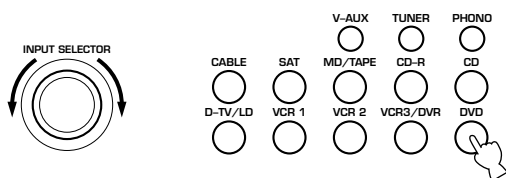

Selected input source

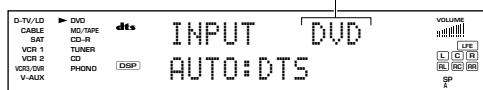

To select a source connected to the **6CH INPUT** jacks, press **6CH INPUT** until "6CH INPUT" appears on the front panel display.

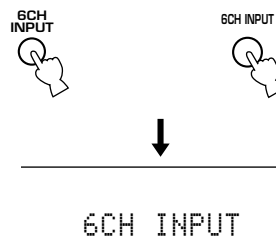

Cautions

- If "6CH INPUT" is shown on the front panel display, no other source can be played. To select another input source with **INPUT SELECTOR** (one of the input selector buttons), press **6CH INPUT** to turn off "6CH INPUT" from the front panel display.
- The input source name corresponds to the jack name to which the input component is connected. If the component is not connected to its corresponding jack, input source name and the playback component do not match. (For example, if a CD player is connected to the MD input jack and MD is selected as an input source, the playback sound will be output from the CD player.) In this case, the input source name can be changed with "7 INPUT RENAME" on the SET MENU.

- 4 Start playback or select a broadcast station on the source component.

Refer to the operation instructions for the component.

5 Adjust the volume to the desired output level.

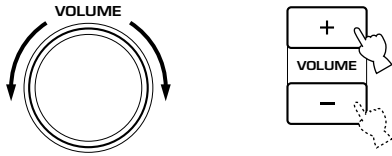

If desired, use **BASS**, **TREBLE**, **BASS EXTENSION** and **BALANCE**. These controls are only effective for sound from the main speakers.

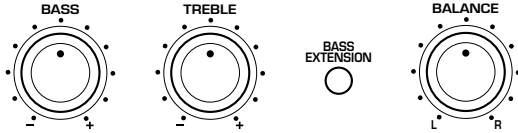

Cautions

- If the component connected to the **VCR 1 OUT**, **VCR 2 OUT**, **VCR 3/DVR OUT**, **CD-R OUT** and **MD/TAPE OUT** jacks is turned off, the reproduced sound may be distorted or the volume may be lowered for the characteristics of A/V component. In this case, turn on the component.
- While **PROCESSOR DIRECT** is tuned on, tone controls (**BASS** and **TREBLE**) or/and **BASS EXTENSION** cannot be activated.

6 Select a DSP program if desired.

Use **PROGRAM** </> (DSP program buttons on the remote control) to select a DSP program. See pages 86 to 94 for details about the DSP program.

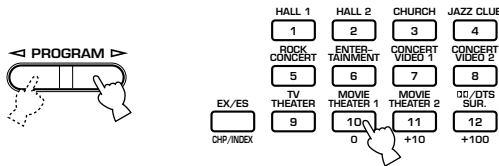

■ BGV (Back Ground Video) function

The BGV (Back Ground Video) function allows you to combine a video signal from a video source with a sound signal from an audio source. (For example, you can listen to classical music while you are watching a video.)

Using the remote control, select a source from the video group, then select a source from the audio group. Use the input selector buttons on the remote control to make your selections.

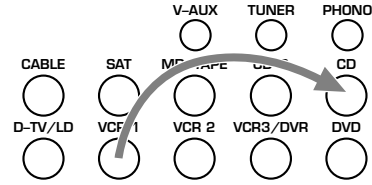

Note

- The BGV function does not work if you select the sources using **INPUT SELECTOR** on the front panel.

■ To mute the sound

Press **MUTE** on the remote control. To resume the audio output, press **MUTE** again.



Notes

- You can also cancel mute to press any operation buttons such as **VOLUME +/-**.
- While the mute function is on, "MUTE ON" appears on the front panel display.
- When this unit enters the standby mode, the mute function will be cancelled.

■ When you have finished using this unit

Press **STANDBY/ON** (**STANDBY** on the remote control) to set this unit in the standby mode.



Input modes and indications

This unit comes with various input jacks. If your external component is connected to more than one type of input jack, you can set the priority of the input signal. Press **INPUT MODE** on the front panel or an input selector button (press it repeatedly) on the remote control to display or change the input mode.

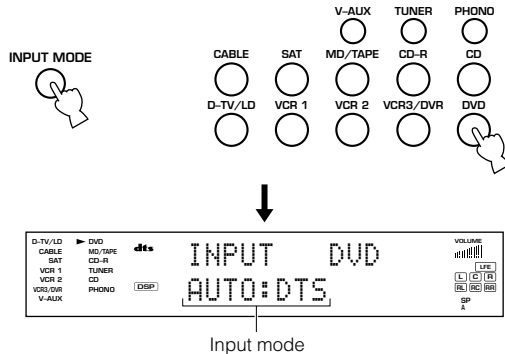

■ Notes on the digital signal

The digital input jacks of this unit can handle up to 192 kHz sampling digital signal. Both **OPTICAL** and **COAXIAL** input jacks can be used to input the digital signal up to 96 kHz. However when inputting the higher digital signals than 96 kHz, be aware the following points.

- DSP programs cannot be selected. Sound will be output as normal 2-channel stereo sound from only the left and right main speakers.
- Use the coaxial input (**COAXIAL IN**) jack to input over 96 kHz digital signal. The signals may not be correctly played back if the optical input (**OPTICAL IN**) jack is used.

Sound effects will be added to 96 kHz sampling digital signals after converted to 48 kHz.

AUTO: This mode is automatically selected when you turn on the power of this unit. In this mode, the input signal is automatically selected in the following order.

- ① Digital signals
- ② Analog signals

<When D-TV/LD is selected as the input source>

- ① Dolby Digital RF encoded signals
- ② Digital signals
- ③ Analog signals

D.D. RF: This unit only selects Dolby Digital RF signals (when **D-TV/LD** is selected as the input source).

DTS: In this mode, only digital input signals encoded with DTS are selected even if other signals are input at the same time.

DGTL: This unit only selects digital signals input through the **OPTICAL** or **COAXIAL** jacks (when **D-TV/LD** is selected as the input source).

ANALOG: In this mode, only analog input signals are selected even if digital signals are input at the same time.

Cautions

- When you turn on the power of this unit, the input mode is set according to “9 INPUT MODE” on the SET MENU (see page 59 for details).
- When you connect components to both the **COAXIAL** and **OPTICAL** jacks, priority is given to the input signals from the **COAXIAL** jack.

■ Notes on playing DTS-CD/LDs

- If the digital output data of the player has been processed in any way, you may not be able to perform DTS decoding even if you make a digital connection between this unit and the player.
- If you play a source encoded with a DTS signal and set the input mode to “ANALOG”, this unit may reproduce the noise of an unprocessed DTS signal. In this case, connect the source to a digital input jack and set the input mode to “AUTO” or “DTS”.
- If you switch the input mode to “ANALOG” while playing a source encoded with a DTS signal, this unit reproduces no sound.
- If you play a source encoded with a DTS signal with the input mode set to “AUTO”, this unit automatically switches to the DTS-decoding mode (The “**dts**” indicator lights up.) after having detected the DTS signal. When playback of the DTS source is completed, the “**dts**” indicator may flash. While this indicator is flashing, only DTS source can be played. If you want to play a normal PCM source soon, set the input mode back to “AUTO”.
- If you play a source encoded with a DTS signal with the input mode set to “AUTO”, the “**dts**” indicator may flash when a search or skip operation is performed while the DTS source is playing back with the input mode set to “AUTO”. If this status continues for longer than 30 seconds, this unit will automatically switch from “DTS-decoding” mode to PCM digital signal input mode. The “**dts**” indicator will turn off.

■ Notes on playing an LD source

- For LD software that does not contain a digital soundtrack, connect the LD player to the analog jacks and set the input mode to “AUTO” or “ANALOG”.
- If the LD player is transmitting a signal by a non-standard method, this unit cannot detect the Dolby Digital or DTS signal. In this case, the decoder automatically switches to PCM or analog.
- Some A/V components such as LD players output different audio signals through their analog and digital jacks. Change the input mode as necessary.
- While you are operating the LD player and playing a disc encoded with a Dolby Digital signal, if you switch from the pause or chapter forwarding function to normal playback, you may hear the PCM or analog sound an instant before the Dolby Digital signal is played. In this case, set the input mode to “D.D.RF”.

Selecting a sound field program

You can enhance your listening experience by selecting a DSP program. There are 12 programs with sub-programs available with this unit. However the selection depends on the input signal format and not all the sub-programs are possible for all input signal formats. For details about each program, see pages 86 to 94.

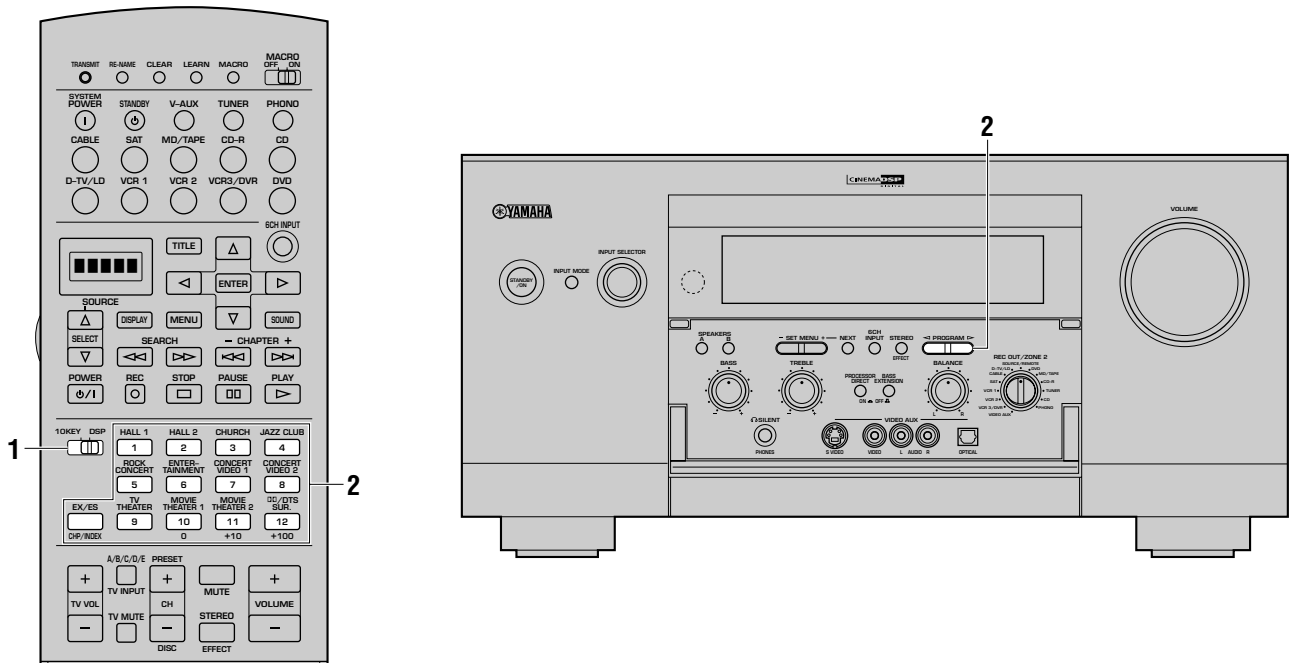

1 Set 10KEY/DSP to DSP on the remote control.

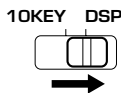

2 Press PROGRAM <=> (one of the DSP program buttons on the remote control) to select the desired program.

After selecting the desired program, press the same button repeatedly to select the desired sub-program if available.

• **Example:** Each time MOVIE THEATER 1 is pressed the subprograms (“Spectacle” and “Sci-Fi”) switch.

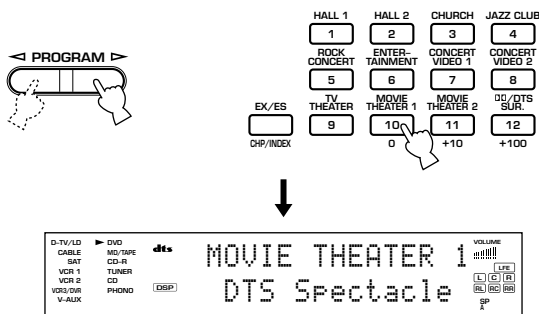

Cautions

- If a Dolby Digital or DTS signal is input when the input mode is set to “AUTO”, the DSP program automatically switches to the appropriate decoding program.
- Choose a DSP program based on your listening preference, and not on the name of the program. The acoustics of your listening room affect the DSP program. Minimize the sound reflections in your room to maximize the effect created by the program.
- When you select an input source, this unit automatically selects the last DSP program used with that source.
- When you set this unit in the standby mode, the current source and DSP program are memorized and are automatically selected when you turn on the power again.
- When a source connected to the 6CH INPUT jacks of this unit is selected, the digital sound field processor cannot be used.
- While the over 96 kHz sampling digital signals are being input, sound effects cannot be added and only normal stereo playback is possible.
- Sound effects will be added to 96 kHz sampling digital signals after converted to 48 kHz.

Normal stereo reproduction

Press **STEREO/EFFECT** to turn off the sound effect for normal stereo reproduction.

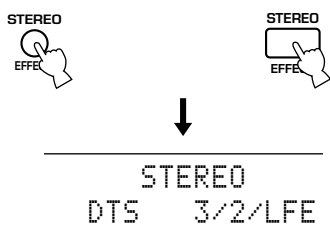

When “STEREO” is selected while Dolby Digital, DTS, or PCM signals are being played, the following information will be shown on the front panel display.

When Dolby Digital signals are played:

“Dolby D” + the number of channels (front/rear/ LFE signal)

```
STEREO
Dolby D 2/0/---
```

When DTS signals are played:

“DTS” + the number of channels (front/rear/ LFE signal)

```
STEREO
DTS 3/2/LFE
```

When PCM signals are played:

“PCM” + sampling frequency

```
STEREO
PCM 48kHz
```

When analog signals are played:

```
STEREO
Analog
```

Cautions

- If you turn off the sound effect, no sound is output from the center speaker, rear speakers, rear center speaker and front effect speakers.
- If you turn off the sound effect while a Dolby Digital or DTS signal is being output, the dynamic range of the signal is automatically compressed and the sounds of the center and rear speaker channels are mixed and output from the main speakers.
- The volume may be greatly reduced when you turn off the sound effect or if you set “12 DYNAMIC RANGE” on the SET MENU to “MIN”. In this case turn on the sound effect.

Displaying the information about the input source

During the stereo reproduction, information about the signal being played back can be displayed by setting **PARAMETER/SET MENU** to **PARAMETER** and then pressing Δ/∇ . The three types of information shown below are displayed as switched every time ∇ is pressed.

fs (Sampling frequency):

```
STEREO
fs:48kHz
```

“unknown” is displayed when the sampling frequency for the input signal is not known.

rate (Bit rate):

```
STEREO
rate:1920kbps
```

“unknown” is displayed when the bit rate of the input signal is not known.

flg (Identification flag):

```
STEREO
flg:ES Mtrx 6.1
```

“None” is displayed when the flag contained in the input signal to be used for signal process cannot be detected.

■ Playing the Dolby Digital EX or DTS ES software

Press **EX/ES** to turn on the Dolby Digital EX or DTS ES decoder to listen to the Dolby Digital EX and DTS ES software with a rear center speaker.

The display changes AUTO → Discrete 6.1 → Matrix 6.1 → OFF each time the **EX/ES** is pressed.

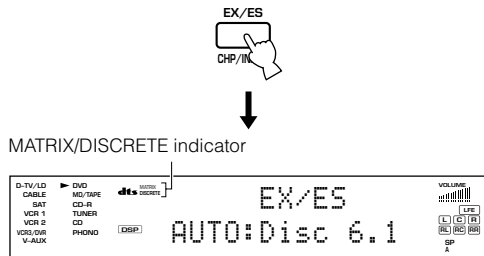

AUTO: This mode automatically switches Dolby Digital EX/DTS ES Matrix 6.1/DTS ES Discrete 6.1 depending on the signal in the input source that this unit can detect. Rear center speaker does not work for 5.1 channel sources.

Discrete 6.1: This mode can be selected when the source with DTS ES Discrete format has been detected. (The “DISCRETE” indicator lights up.)

Matrix 6.1: This mode makes 6-channel playback of the input source with Matrix or Matrix compatible format through the Matrix 6.1 decoder. (The “MATRIX” indicator lights up.)

OFF: Rear center speaker does not work in this mode.

Cautions

- Some 6.1-channel compatible discs do not have the signal (flag) which this unit can automatically detect. When playing this kind of discs with 6.1 channel, select “Matrix 6.1”.
- 6.1-channel playback is not possible even if **EX/ES** is pressed in the following cases:
 - ① when “1C REAR L/R SP” is set to “NONE”
 - ② when the sound effect is turned off
 - ③ when the source connected to the **6CH INPUT** jack is being played
 - ④ when Dolby Digital KARAOKE source is being played

■ Selecting PRO LOGIC, PRO LOGIC II or Neo: 6

You can enjoy the 2-channel sources decoded into five or six discrete channels by selecting PRO LOGIC, PRO LOGIC II or Neo: 6 in the program No. 12.

1 Select a 2-channel source and start playback on the source component.

2 Press the numeric button 12 repeatedly to select the decoder; PRO LOGIC, PRO LOGIC II or Neo: 6.

The decoder selection switches among PRO LOGIC, PRO LOGIC II and Neo: 6 on the front panel display.

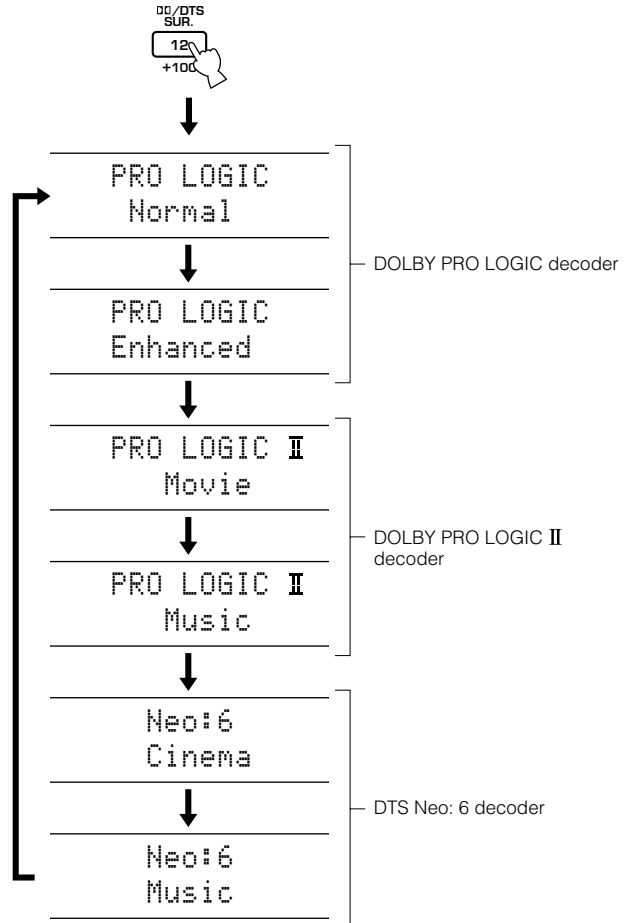

Cautions

- Playback using DOLBY PRO LOGIC II and DTS Neo: 6 decoders is possible only for 2-channel signals.
- **PROGRAM** </> on the front panel can be also used to select these programs.

■ Virtual CINEMA DSP

With the Virtual CINEMA DSP, you can enjoy all the DSP programs without rear speakers. It creates the virtual speakers to reproduce the natural sound field.

The sound field processing is changed to the Virtual CINEMA DSP mode according to the selected DSP program by setting “1C REAR L/R SP” on the SET MENU to “NONE”.

Caution

- This unit is not set in the virtual CINEMA DSP mode even if “1C REAR L/R SP” is set to “NONE” in the following cases:

- ① when the 8ch Stereo, DOLBY DIGITAL Normal, PRO LOGIC Normal, PRO LOGIC II, DTS Normal or Neo: 6 program is selected;
- ② when the sound effect is turned off
- ③ when connecting the headphones
- ④ when **6CH INPUT** is selected as the input source
- ⑤ when over 96 kHz sampling digital signals are being input

■ SILENT CINEMA DSP

You can enjoy the powerful sound field as if there were actual speakers with the SILENT CINEMA DSP. You can listen to SILENT CINEMA DSP by connecting your headphones to the **PHONES** jack while the digital sound field processor is on. Enjoy all the DSP program using the headphones. The “SILENT” indicator lights up on the front panel display. (If the sound effect is off, you listen to the source with normal stereo reproduction.)

Caution

- This unit is not set in the SILENT CINEMA DSP mode even if the sound effect is on in the following cases:

- ① when over 96 kHz sampling digital signals are being input
- ② when **6CH INPUT** is selected as the input source

■ DTS 96/24

Be aware the following points when the DTS 96/24 signal is being input.

- Select the subprogram “NORMAL” in “DOLBY DIGITAL/DTS SURROUND” among CINEMA DSP programs in order to decode the DTS 96/24 signals correctly.
- Press **EX/ES** while the DTS 96/24 signals are being input for matrix 6.1 playback.
- DTS 96/24 decoder functions only for those two cases described above. In other cases, necessary process such as sound effect addition and down mixing is given depending on the sampling frequency of the input signals.

96kHz/24bit indicator lights up when the DTS 96/24 signal is input to this unit.

BASIC RECORDING

REC OUT/ZONE 2 allows you to record one source while viewing and/or listening to another source.

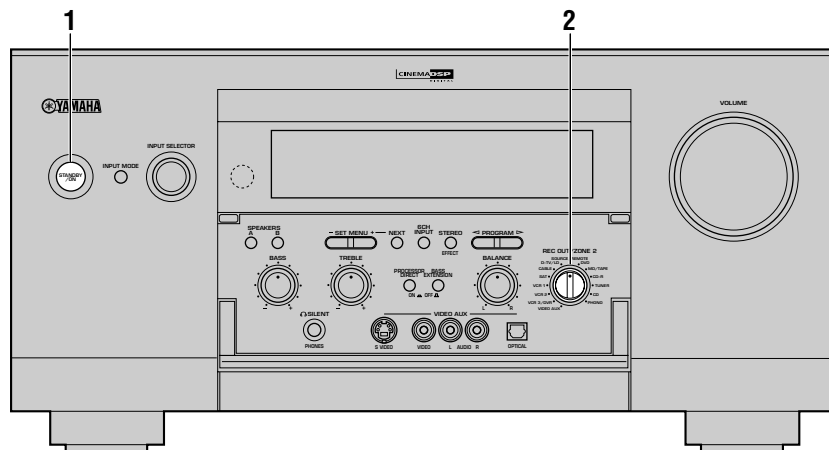

- 1 Turn on the power to this unit and all connected components.
- 2 Select the source component you want to record from by using **REC OUT/ZONE 2**.

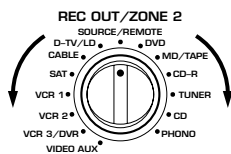

To record the current input source that you are watching or listening to, set **REC OUT/ZONE 2** to **SOURCE/REMOTE**. To record the other source than the one that you are watching or listening to, set **REC OUT/ZONE 2** to the source you want to record.

- 3 Start playback (or select a broadcast station) on the source component.
- 4 Start recording on the recording component.

Notes

- Do a test recording before you start an actual recording.
- It is not possible to record the sound effect created by this unit's DSP processing.
- When this unit is set in the standby mode, you cannot record between other components connected to this unit.
- Operating **BASS** and **TREBLE**, **BASS EXTENSION**, **BALANCE**, **VOLUME**, and DSP programs do not affect the recorded signal.
- Setting **REC OUT/ZONE 2** to **SOURCE/REMOTE** and using the BGV function (see page 43) allows the recording of audio and video from a different source.
- Use **INPUT SELECTOR** to switch the source from the one you are watching or listening to while making recordings with **REC OUT/ZONE 2** set to the source component you are recording from.

Cautions

- A given input source is not output on the same **REC OUT** channel. (For example, the signal input from **VCR 1 IN** is not output on **VCR 1 OUT**.)
- S-video and composite video signals pass independently through this unit's video circuits. Therefore, when recording or dubbing video signals, if your video source component is connected to provide only an S-video (or only a composite video) signal, you can record only an S-video (or only a composite video) signal by your VCR.
- **DIGITAL OUTPUT** jacks and analog **OUT (REC)** jacks are independent. Only digital signals are output from **DIGITAL OUTPUT** jacks and analog signals from **OUT (REC)** jacks.
- A source connected to the **6CH INPUT** jacks of this unit cannot be recorded.
- The **LD RF (AC-3)** input signal cannot be output using **REC OUT/ZONE 2**.
- Check the copyright laws in your country to record from records, CDs, radio, etc. Recording of copyrighted material may infringe copyright laws.

Special considerations when recording DTS software

The DTS signal is a digital bitstream. Attempting to digitally record the DTS bitstream will result in noise being recorded. Therefore, if you want to use this unit to record sources that have DTS signals recorded on them, the following considerations and adjustments need to be made. For LDs, DVDs and CDs encoded with DTS, when your player is compatible with the DTS format, follow its operation instruction to make a setting so that the analog signal will be output from the player.

Advanced operation

This section explains SET MENU setting, remote control features and the other functions.

SET MENU ITEMS	52
Operating the SET MENU	53
1 SPEAKER SET	54
2 LOW FREQ. TEST	54
3 HP TONE CTRL (headphone tone control)	55
4 CENTER GEQ (center graphic equalizer)	55
5 REAR CT GEQ (rear center graphic equalizer)	55
6 CINEMA EQ	56
7 INPUT RENAME	57
8 I/O ASSIGNMENT	58
9 INPUT MODE (initial input mode)	59
10 PARAMETER INI (parameter initialization)	59
11 LFE LEVEL	59
12 DYNAMIC RANGE	60
13 SP DELAY	60
14 AUDIO DELAY	61
15 DISPLAY SET	62
16 MEMORY GUARD	62
17 ZONE2 SET	63
18 6CH INPUT SET	63
REMOTE CONTROL FEATURES	64
Using the remote control	64
Setting the manufacturer code	66
Programming a new remote control function (Learn feature)	68
Each component control area	70
Using the Macro feature	75
Changing the source name in the display window	78
Clearing a learned function or macro	79
Clearing learned functions, macros, renamed source names, and setup manufacturer codes	80
ADJUSTING THE LEVELS OF THE EFFECT SPEAKERS	81
SLEEP TIMER	82
ZONE 2	83
Connections	83
Remote control in ZONE 2	84

SET MENU ITEMS

The SET MENU consists of eighteen items including the Speaker Set, Center Graphic Equalizer and Parameter Initialization features. Choose the appropriate item and adjust or select the values as necessary.

Notes

- You can adjust the items in the SET MENU while reproducing a source.
- We recommend that you adjust the items in the SET MENU while using a video monitor. It is easier to see the video monitor screen than it is to see the front panel display on this unit while adjusting SET MENU items.

1 SPEAKER SET	1A CENTER SP	Selects the output mode suitable for your center speaker.
	1B MAIN SP	Selects the output mode suitable for your main speakers.
	1C REAR L/R SP	Selects the output mode suitable for your rear speakers.
	1D REAR CT SP	Selects the output mode suitable for your rear center speaker.
	1E LFE/BASS OUT	Selects the speakers for your LFE/BASS signal output.
	1F FRONT EFCT SP	Selects the output mode for your front effect speakers.
	1G MAIN LEVEL	Selects the output level for your main channels.
2 LOW FREQ. TEST	Matches the subwoofer level with the level of the other speakers.	
3 HP TONE CTRL	Adjusts the tonal balance of the headphones.	
4 CENTER GEQ	Matches the center speaker tonal quality with the main speakers.	
5 REAR CT GEQ	Matches the rear center speaker tonal quality with the rear speakers.	
6 CINEMA EQ	Adjusts the tonal balance of the main and center speakers, front effect speakers, rear speakers and rear center speaker separately.	
7 INPUT RENAME	Changes the name of the inputs.	
8 I/O ASSIGNMENT	Assigns the I/O terminals to the designated input sources.	
9 INPUT MODE	Selects the initial input mode of the sources.	
10 PARAMETER INI	Initializes the parameters of a group of DSP programs.	
11 LFE LEVEL	Adjusts the output level of the LFE channel for Dolby Digital or DTS signals.	
12 DYNAMIC RANGE	Adjusts the dynamic range for Dolby Digital signals.	
13 SP DELAY	Adjusts the delay time for center and rear center speakers.	
14 AUDIO DELAY	Adjusts the delay time for all channels.	
15 DISPLAY SET	Sets the background or position of on screen displays and changes the brightness of this unit's front panel display.	
16 MEMORY GUARD	Locks DSP program parameters and other SET MENU settings.	
17 ZONE2 SET	Selects the mode of Zone 2.	
18 6CH INPUT SET	Sets the destination of the center channel and subwoofer channel signals that are input into the 6CH INPUT jacks.	

Operating the SET MENU

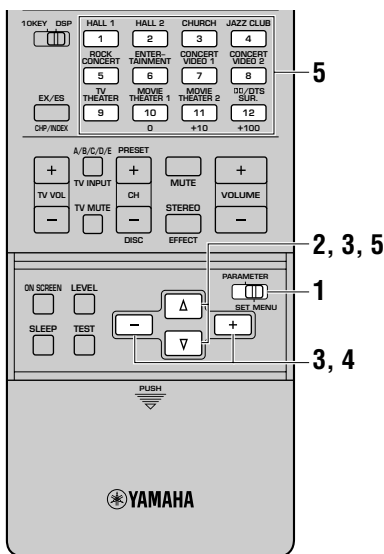

Adjustment should be performed with the remote control.

Notes

- Some items require extra steps to change to the desired setting.
- **NEXT** and **SET MENU +/-** on the front panel can be also used.

1 Set **PARAMETER/SET MENU** to **SET MENU**.

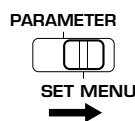

2 Press Δ/∇ repeatedly to select the item (1 to 18) you want to adjust.

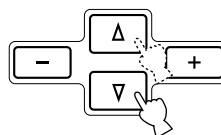

3 Press +/- once to enter the setup mode of the selected item.

The last setting you adjusted appears on the video monitor or on the front panel display. Depending on the item, press Δ/∇ to select a sub item.

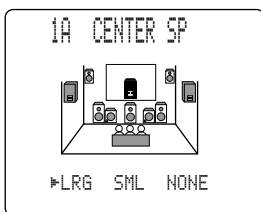
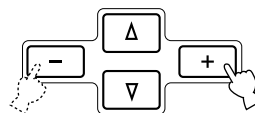

4 Press +/- repeatedly to change the setting of the item.

5 Press Δ/∇ repeatedly until the current DSP program appears or simply press one of the DSP program buttons to exit from the SET MENU.

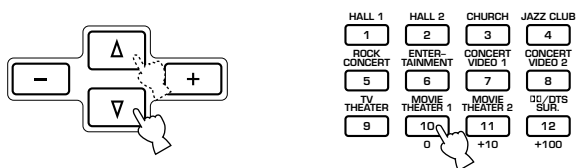

1 SPEAKER SET

Set the speaker mode depending on your speaker system. See “SPEAKER MODE SETTINGS” on pages 34 to 37 for details about the setting items.

2 LOW FREQ. TEST

Use this feature to adjust the output level of the subwoofer so it matches that of the other speakers in your configuration.

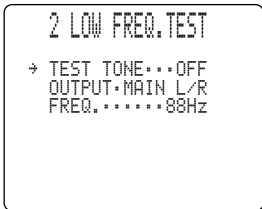

1 Press +/- to set “TEST TONE” to “ON”.

Cautions

- “ON” cannot be selected when the headphones are being used.
- Setting turns to “OFF” if the headphones are connected during testing.
- While the test tone is being output, the source sound cannot be output.

2 Adjust the volume with VOLUME +/- so you can hear the tone.

Cautions

- Do not turn up the volume too high.
- If no test tone is heard, turn down the volume, set this unit in the standby mode and make sure all the necessary connections are correct.

3 Press ▾ to go to “OUTPUT” and press +/- to select the speaker you want to compare with the subwoofer.

If “SWFR” is selected, the test tone above 90 Hz will not be output from the subwoofer. The test tone will not necessarily be output from the selected speakers. The output mode of the test tone depends on the settings of “1 SPEAKER SET” on the SET MENU.

4 Press ▾ to go to “FREQ.” and press +/- to select the frequency you want to use.

Set the center frequency (35 – 250 Hz or “35-250Hz”) to check that the subwoofer level matches that of the other speakers.

5 Adjust the volume of the subwoofer with the controls on the subwoofer so it matches that of the speaker you are comparing it to.

■ About the test tone

Digital generator
(wide band noise produced)

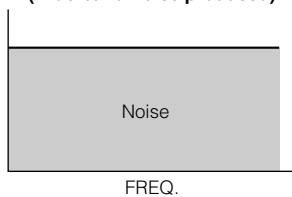

Band pass filter

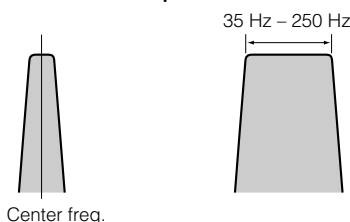

- The test tone is produced by the tone generator. The tone generator produces a narrow-band noise centered on a specified frequency by the band pass filter.
- You can change this center frequency from 35 Hz through 250 Hz in one-sixth octave steps.
- You can use the test tone not only for adjusting the subwoofer level, but also for checking the low-frequency characteristics of your listening room. Low-frequency sounds are especially affected by the listener’s position, speaker placement, subwoofer polarity and other conditions.

3 HP TONE CTRL (headphone tone control)

Use this feature to adjust the level of the bass and treble when you use your headphones.

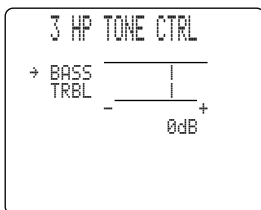

Control range (dB): -6 – +3 for both BASS and TRBL (treble)
Initial setting: 0 dB for both BASS and TRBL (treble)

- 1 Select “BASS” or “TRBL”.
- 2 Press +/- to change each level.

4 CENTER GEQ (center graphic equalizer)

Use this feature to adjust the built-in 5-band graphic equalizer so that the center speaker tonal quality matches that of the left and right main speakers.

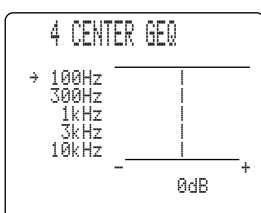

Control range (dB): -6 – +6
Initial setting: 0 dB for 5-band

- 1 Press ∇ to select a higher frequency and Δ to select a lower frequency.
You can select the 100 Hz, 300 Hz, 1 kHz, 3 kHz, or 10 kHz frequencies.
- 2 Press +/- to adjust the level of that frequency.

Note

- You can monitor the center speaker sound while adjusting this item by using the test tone. Press **TEST** before starting the foregoing procedure. “TEST DOLBY SUR.” (or “TEST DSP”) appears on the video monitor, and the test tone starts alternating among the speakers. Once you begin this procedure, the test tone remains at the center speaker and you can hear how the sound changes as you adjust the various frequency levels. To stop the test tone, press **TEST** (see pages 39 and 40).

5 REAR CT GEQ (rear center graphic equalizer)

Use this feature to adjust the built-in 5-band graphic equalizer so the rear center speaker tone matches that of the left and right rear speakers.

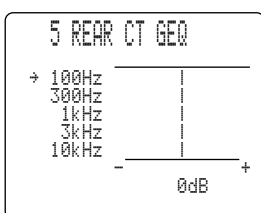

Control range (dB): -6 – +6
Initial setting: 0 dB for 5-band

- 1 Press ∇ to select a higher frequency and Δ to select a lower frequency.
You can select the 100 Hz, 300 Hz, 1 kHz, 3 kHz, or 10 kHz frequencies.
- 2 Press +/- to adjust the level of that frequency.

Note

- You can monitor the rear center speaker sound while adjusting this item by using the test tone. Press **TEST** before starting the foregoing procedure. “TEST DOLBY SUR.” (or “TEST DSP”) appears on the video monitor, and the test tone starts alternating among the speakers. Once you begin this procedure, the test tone remains at the rear center speaker and you can hear how the sound changes as you adjust the various frequency levels. To stop the test tone, press **TEST** (see pages 39 and 40).

6 CINEMA EQ

Use this feature to match the tonal quality of four groups of speakers: the main and center speaker group, the front effect speakers group, the rear speakers group, and the rear center speaker group. CINEMA-EQ consists of a high-shelving equalizer (HIGH) and a parametric equalizer (PEQ). The high-shelving equalizer changes high frequency characteristics, and the parametric equalizer boosts or cuts any selected frequency. The equalizer can be used for a variety of purposes, such as adjusting the tonal quality of differing types of speakers, adjusting the tonal quality in different installation environments, or adjusting the source sound to your liking.

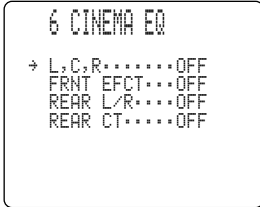

1 Press Δ/∇ repeatedly to select one of the speaker groups and press +/- to select "ON".

2 Press Δ/∇ several times to display the setting screen for the channel to be set.

There are 4 groups (6A – 6D) to be set.

Caution

- If "OFF" is selected in step 1, the setting screen for that group will not be displayed.

3 Press Δ/∇ to select the item to be adjusted.

Select one item at each time from "FRQ"/"GAIN" for "HIGH" and "FRQ"/"GAIN" for "PEQ".

4 Adjust the value for the item by pressing +/-.

"FRQ" (frequency) for "HIGH" is to set the turn over frequency and "PEQ" for the band central frequency. The amplification increases for higher "GAIN" value while the attenuation increases for lower "GAIN" value.

Notes

- When any change has been made on the initial setting, * (asterisk) will be placed in front of its parameter name.
- CINEMA-EQ does not work when you press **STEREO/EFFECT** to turn off the effect.
- While "TEST DOLBY SUR." or "TEST DSP" is being activated, the test tones are output as described below.
 - 1 6A L,C,R EQ:** The test tones are output from the main L/R and center channels. (When "1A CENTER SP" is set to "NONE", the test tones are output from the main L/R only.)
 - 2 6B FRNT EFCT EQ:** The test tones are output from the front effect channels.
 - 3 6C REAR L/R EQ:** The test tones are output from the rear L/R channels.
 - 4 6D REAR CT EQ:** The test tones are output from the rear center channels.

■ 6A L, C, R EQ (main L/center/main R equalizer)

Use this feature to adjust the tonal quality of the main L/R and center channels.

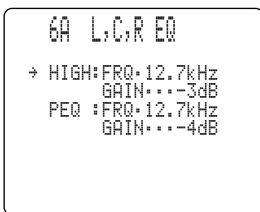

Control range: 1.0 kHz – 12.7 kHz (HIGH: FRQ, PEQ: FRQ),
-9 dB – +6 dB (HIGH: GAIN, PEQ: GAIN)

Initial setting: 12.7 kHz (HIGH: FRQ, PEQ: FRQ), -3 dB (HIGH: GAIN),
-4 dB (PEQ: GAIN)

■ 6B FRNT EFCT EQ (front effect equalizer)

Use this feature to adjust the tonal quality of the front effect channels.

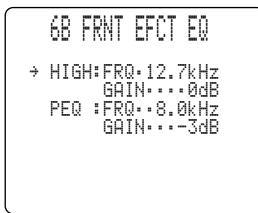

Control range: 1.0 kHz – 12.7 kHz (HIGH: FRQ, PEQ: FRQ),
-9 dB – +6 dB (HIGH: GAIN, PEQ: GAIN)

Initial setting: 12.7 kHz (HIGH: FRQ), 8.0 kHz (PEQ: FRQ),
0 dB (HIGH: GAIN), -3 dB (PEQ: GAIN)

■ 6C REAR L/R EQ (rear L/R equalizer)

Use this feature to adjust the tonal quality of the rear L/R channels.

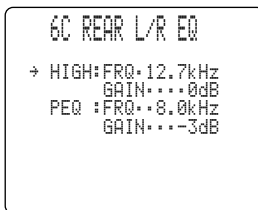

Control range: 1.0 kHz – 12.7 kHz (HIGH: FRQ, PEQ: FRQ),
-9 dB – +6 dB (HIGH: GAIN, PEQ: GAIN)

Initial setting: 12.7 kHz (HIGH: FRQ), 8.0 kHz (PEQ: FRQ),
0 dB (HIGH: GAIN), -3 dB (PEQ: GAIN)

■ 6D REAR CT EQ (rear center equalizer)

Use this feature to adjust the tonal quality of the rear center channel.



Control range: 1.0 kHz – 12.7 kHz (HIGH: FRQ, PEQ: FRQ),
-9 dB – +6 dB (HIGH: GAIN, PEQ: GAIN)

Initial setting: 12.7 kHz (HIGH: FRQ), 8.0 kHz (PEQ: FRQ),
0 dB (HIGH: GAIN), -3 dB (PEQ: GAIN)

7 INPUT RENAME

Use this feature to change the name of the input which appears on the OSD or the front panel display.

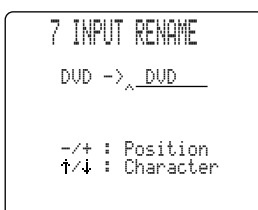

- 1 Select the input you want to change the name of by pressing an input selector button.
- 2 Press +/- to place the “^” under the space or the character you want to edit.
- 3 Press Δ/∇ to select the character you want to use.
Press ∇ to change the character in the following order, or press Δ to go in the reverse order.
A – Z, a space, 0 – 9, a space, a – z, a space, #, *, +, and so on.
- 4 Press +/- to move to the next one.
- 5 Press +/- repeatedly to exit the INPUT RENAME mode.

8 I/O ASSIGNMENT

It is possible to assign jacks according to the component to be used if this unit's **COMPONENT VIDEO INPUT** jack or **DIGITAL INPUT/OUTPUT** jack settings (component names for jacks) differ from that component. This makes it possible to change the jack assignment and effectively connect more component.

Once you assign, you can select that component with **INPUT SELECTOR** (the input selector buttons on the remote control).

Caution

- You cannot assign the same component for different jacks of each item (8A – 8D).

■ 8A <1> to <4> COAXIAL INPUT jacks

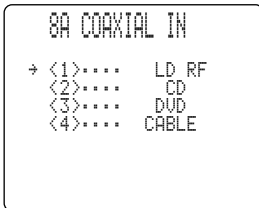

Choices: LD RF (<1> only), V-AUX, VCR3/DVR, VCR2, VCR1, SAT, CABLE, D-TV/LD, DVD, MD/TAPE, CD-R, TUNER, CD, PHONO

Initial settings: <1> LD RF, <2> CD, <3> DVD, <4> CABLE

■ 8B <5> and <6> OPTICAL OUTPUT jacks

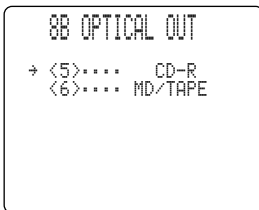

Choices: CD-R, TUNER, CD, PHONO, V-AUX, VCR3/DVR, VCR2, VCR1, SAT, CABLE, D-TV/LD, DVD, MD/TAPE

Initial settings: <5> CD-R, <6> MD/TAPE

■ 8C <7> to <12> OPTICAL INPUT jacks

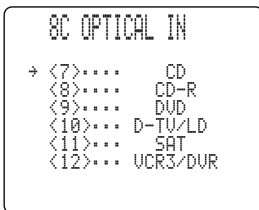

Choices: CD, PHONO, VCR3/DVR, VCR2, VCR1, SAT, CABLE, D-TV/LD, DVD, MD/TAPE, CD-R, TUNER

Initial settings: <7> CD, <8> CD-R, <9> DVD, <10> D-TV/LD, <11> SAT, <12> VCR3/DVR

■ 8D [A] to [C] COMPONENT VIDEO INPUT jacks



Choices: DVD, V-AUX, VCR3/DVR, VCR2, VCR1, SAT, CABLE, D-TV/LD

Initial settings: [A] DVD, [B] D-TV/LD, [C] SAT

9 INPUT MODE (initial input mode)

Use this feature to designate the input mode for sources connected to the **COAXIAL (OPTICAL) IN** jacks when you turn on this unit (see page 44 for details about the input mode).

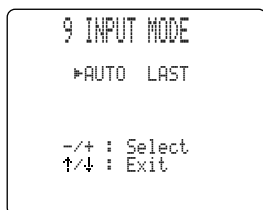

Choices: AUTO, LAST
Initial setting: AUTO

AUTO: Select this to allow this unit to automatically detect the type of input signal and select the appropriate input mode.

LAST: Select this to set this unit to automatically select the last input mode used for that source.

Caution

- Even if “LAST” is selected, the setting for **EX/ES** is not stored in memory.

10 PARAMETER INI (parameter initialization)

Use this feature to initialize the parameters for each DSP program within a DSP program group. When you initialize a DSP program group, all of the parameter values within that group revert to their initial settings.

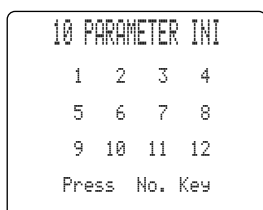

Press the corresponding numeric button for the DSP program that you want to initialize. The asterisk (*) next to the program number means that the parameter values have been changed.

Cautions

- You cannot initialize the individual DSP programs within a group separately.
- The parameter values of the DSP programs do not change if you initialize a program group that does not have the asterisk mark (*).
- When “16 MEMORY GUARD” is set to “ON” (see page 62), you cannot initialize any program groups.
- Once you initialize a DSP program group, you cannot automatically revert to the previous parameter settings.

11 LFE LEVEL

Use this feature to adjust the output level of the LFE (low-frequency effect) channel when playing back a Dolby Digital or DTS signal. The LFE signal carries the low-frequency special effect sound which is only added to certain scenes.



Control range (dB): -20 – 0 for both SPEAKER and HEADPHONE

Initial setting: 0 dB for both SPEAKER and HEADPHONE

- 1 Press Δ/∇ to select the item to be adjusted.
- 2 Press +/- to adjust the LFE level.

Note

- Adjust the LFE level according to the capacity of your subwoofer or headphones.

12 DYNAMIC RANGE

Use this feature to adjust the dynamic range. This setting is effective only when this unit decodes Dolby Digital signals.

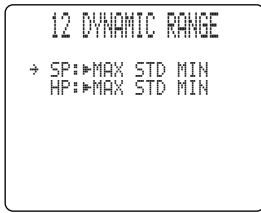

Choices: MAX, STD, MIN
Initial setting: MAX (for both speakers and headphones)

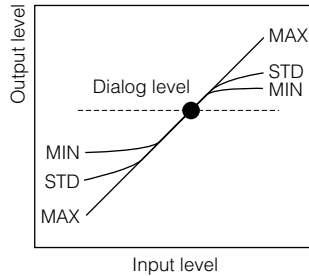

MAX: Select the “MAX” setting for feature films.
STD: Select the “STD” (Standard) setting for general use.
MIN: Select the “MIN” setting for listening to sources at extremely low volume levels.

Caution

- Some types of the Dolby Digital software do not support “MIN” for the dynamic range. If “MIN” is selected to play this type of software, the volume may be extremely lowered. If this problem occurs, select “MAX” or “STD”.

13 SP DELAY

Use this feature to adjust the delay of the center and the rear center channel sounds. This feature works when there is sound output from the center speakers, with a source like Dolby Digital or DTS, etc.

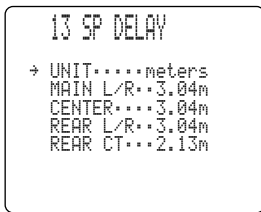

Ideally, the center speaker and the rear center speaker should be the same distance from the main listening position as the left and right main speakers. However, in most home situations, the center speaker or the rear center speaker is placed in line with the main speakers or the rear speakers. By delaying the sound from the center speaker and the rear center speaker, the apparent distance from the center speaker and the rear center speaker to the main listening position can be adjusted to make it seem the same as the distance between the left and right main speaker, and the left and right rear speakers to the listening position. Adjusting the delay time for the center speaker is especially important for giving depth to the dialogue.

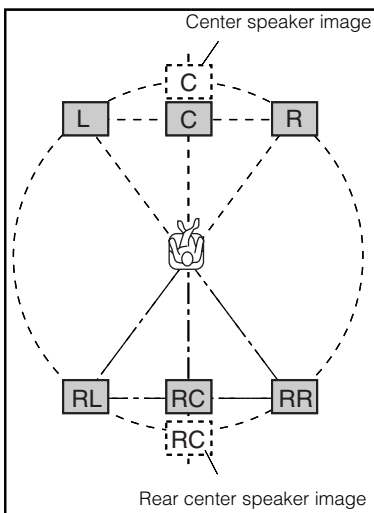

- 1 Press Δ/∇ to select “UNIT”.
- 2 Press $+/-$ to select the unit to be used for setting.
 Select one from “msec”, “meters”, and “feet”.
Notes
 - Setting items change depending on the unit chosen.
 - When “meters” or “feet” is selected, enter the distance from your listening position to each speaker.
- 3 Press Δ/∇ to select the speaker for which the delay is adjusted.
- 4 Press $+/-$ to set the delay.
 Press + for higher value and – for lower value.

■ Setting by “msec”

```

13 SP DELAY
→ UNIT.....msec
  CENTER.....0ms
  REAR CT...3.0ms
  
```

Control range: 0 – 5.0 ms (for center), 0 – 30.0 ms (for rear center)
Initial settings: 0 ms (for center), 3.0 ms (for rear center)

■ Setting by “meters”

```

13 SP DELAY
→ UNIT.....meters
  MAIN L/R...3.04m
  CENTER...3.04m
  REAR L/R...3.04m
  REAR CT...2.13m
  
```

Control range: 0.15 – 30.48 m (for main L/R, center, rear L/R, rear center)
Initial settings: 3.04 m (for main L/R, center, rear L/R), 2.13 m (for rear center)

■ Setting by “feet”

```

13 SP DELAY
→ UNIT.....feet
  MAIN L/R...10.0ft
  CENTER...10.0ft
  REAR L/R...10.0ft
  REAR CT...7.0ft
  
```

Control range: 0.5 – 100 ft (for main L/R, center, rear L/R, rear center)
Initial settings: 10.0 ft (for main L/R, center, rear L/R), 7.0 ft (for rear center)

Caution

- No delay will be set if the same distance is set for the main L/R and center, or the rear L/R and rear center with “meters” or “feet” selected.

14 AUDIO DELAY

Use this feature to adjust the delay time of all channel sounds, when this unit decodes DTS or Dolby Digital signals. Adjusting “AUDIO DELAY” is especially important for matching the sounds to screen pictures.

```

14 AUDIO DELAY
      0ms
  
```

Control range: 0 – 160 ms
Initial setting: 0 ms

Note

- This feature is effective when the Dolby Digital, DTS or PCM (with the sampling frequency lower than 96 kHz) signal is being played. The set value can be used for either format and applies to all channels.

15 DISPLAY SET

Use this feature to set the background and the location of the OSD, and the brightness of this unit's front panel display.

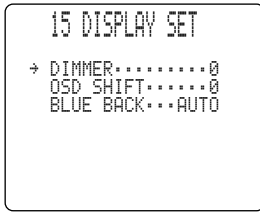

■ DIMMER

You can adjust the brightness of the front panel display.

Control range: -4 - 0
Initial setting: 0

■ OSD SHIFT (OSD off-set position)

This setting is used to adjust the vertical position of the OSD.

Control range: +5 (downward) - -5 (upward)
Initial setting: 0

Press + to lower the position of the OSD. Press - to raise the position of the OSD.

■ BLUE BACK

This item sets the OSD background.

Choices: AUTO, OFF
Initial setting: AUTO

AUTO: Blue background is displayed when no video signal is being input.

OFF: Nothing is displayed when no video signal is being input.

Caution

- With "OFF" selected, no on-screen display is shown on the video monitor when no video signal is being input.

16 MEMORY GUARD

Use this feature to prevent accidental changes to DSP program parameter values and other settings on this unit.

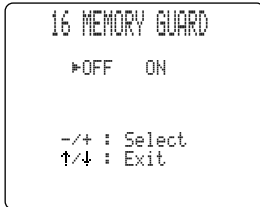

Initial setting: OFF

Select "ON" to protect the following features:

- DSP program parameters
- All SET MENU items except "16 MEMORY GUARD"
- Center, front effect, rear speakers, rear center, and subwoofer levels
- The on-screen display (OSD) mode

Cautions

- When "16 MEMORY GUARD" is set to "ON", you cannot select any other SET MENU items.
- When "16 MEMORY GUARD" is set to "ON", you cannot use the test tone.

17 ZONE2 SET

Use this feature to change the volume control setting for audio output to **ZONE 2 OUT**.

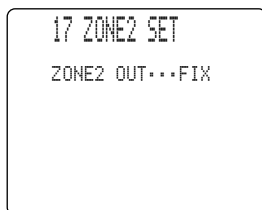

Choices: VAR., FIX
Initial setting: FIX

VAR.: To adjust the **ZONE 2 OUT** volume with **VOLUME +/-** on the remote control.
FIX: To fix the **ZONE 2 OUT** volume to the volume level of this unit.

18 6CH INPUT SET

Use this feature to set the direction of the signals input into the center and subwoofer channels when the source component is connected to the **6CH INPUT** jacks.

■ 18A CENTER to (direction of the center channel signals)

This item sets the direction of the signals input into the **CENTER** jack.



Choices: CENTER, MAIN
Initial setting: CENTER

CENTER: The input signals are output from the center speaker.
MAIN: The input signals are directed to the main L/R speakers with same level.

■ 18B SWFR to (direction of the signals input into the subwoofer)

This item sets the direction of the signals input into the **SUBWOOFER** jack.

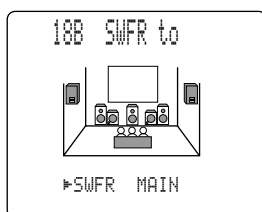

Choices: SWFR, MAIN
Initial setting: SWFR

SWFR: The input signals are output from the subwoofer.
MAIN: The input signals are directed to the main L/R speakers with same level.

REMOTE CONTROL FEATURES

The remote control can operate not only the main unit but also other Yamaha and other manufactures' audio and video components by using the Learning function and other manufactures' code settings. The Macro feature also improves the operability of this unit allowing you to program a series of operations in sequence onto a single button.

Using the remote control

■ Main unit control area

The main unit control area is the shaded area shown below. It is for controlling this unit. You can use functions within this area no matter which component control area is selected.

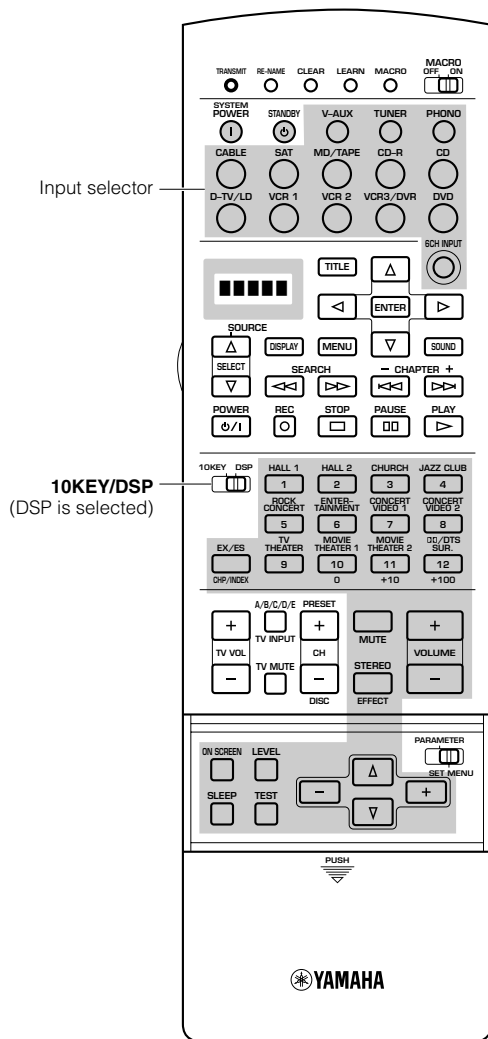

■ Component control area

The component control area is the shaded area shown below. Each component has different functions for operation buttons in the component control area. The component, which was chosen by pressing an input selector button, can be controlled and the display window shows the corresponding name of the input.

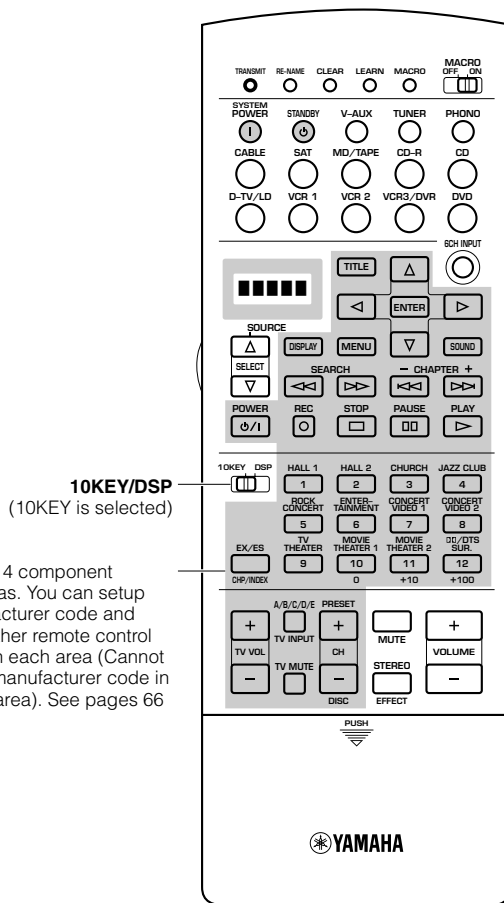

There are 14 component control areas. You can setup the manufacturer code and program other remote control functions in each area (Cannot setup the manufacturer code in the OPTN area). See pages 66 to 69.

■ Source select

You can control another component independently from the input you selected by pressing an input selector button. Press **SOURCE SELECT** Δ/∇ to choose a component and set the remote control to be used for it.

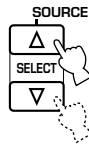

■ About Zone2

When you make up a second audio-video room with this unit's Zone2 system, you might want to use this remote control. Pressing **SOURCE SELECT** Δ selects Zone2 first. See page 84 for details.

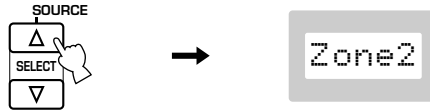

■ About OPTN

OPTN is an extra component control area to be programmed with other remote control functions. (You cannot setup the manufacturer code in this area.) Pressing **SOURCE SELECT** ∇ selects OPTN first.



Caution

- You cannot set the manufacturer code in the OPTN area.

■ Light up function

The buttons which are active and the display window light up for 10 seconds after pressing **LIGHT**.

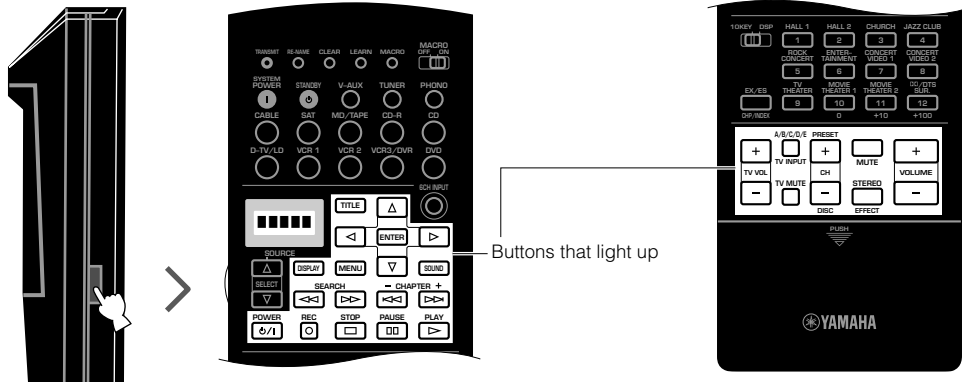

Only buttons that send the signals light up in orange.

These buttons light up in red regardless of input source selection.

Setting the manufacturer code

You can control other components by setting a manufacturer code. A code can be set up in each component control area except for the OPTN area. The Yamaha code is factory preset for **TUNER**, **MD/TAPE**, **CD-R**, **CD** and **DVD**.

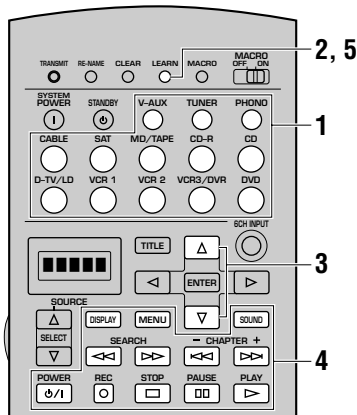

- 1 Select the source component you want to preset by using the input selector buttons.
- 2 Press and hold **LEARN** for about 3 seconds by using a ballpoint pen or similar object. "SETUP" and the selected component name appear alternately in the display window.

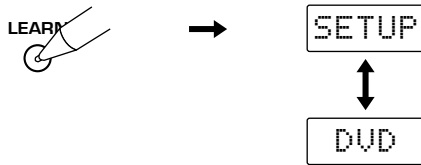

Cautions

- If you do not press any button within 30 seconds during step 3, the setup process is canceled. If this happens, start over from step 2.
 - Press **LEARN** for at least 3 seconds, otherwise the learning process is started.
- 3 Press **Δ/∇** to select the name of your component's manufacturer. You will find the names of most worldwide audio-video manufacturers in alphabetical order in the display window.

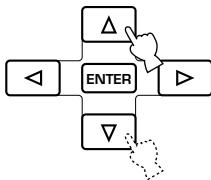

- 4 Press **POWER** (or any other button) on the remote control while pointing it at the component to check if you have set up the code correctly. If the component cannot be controlled by the remote control, try entering another code for the same manufacturer.
- 5 Press **LEARN** again to exit from the setup mode.



Cautions

- Supplied remote control does not store all the manufacturer codes for commercially available AV components (including Yamaha AV components). Therefore it may not work to operate your AV component. If operation is not possible with any of the manufacturer codes, program the new remote control function with the Learn feature (see pages 68 and 69) or use the remote control for the component.
- Only one manufacturer code can be set for each input selector button.
- If you have already programmed a remote control function for a button, the function by learning or macro programming takes priority over the setup manufacturer code's function.
- "ERROR" appears in the display window under the following circumstances:
 - 1 when pressing more than one button at once
 - 2 when **MACRO ON/OFF**, **10KEY/DSP** or **PARAMETER/SET MENU** is switched to another position

Changing the component category (Library)

Although a component category (Library) is preset for each input selector button, you can change it. For example, “VCR” is preset in **V-AUX**. If you want to operate your TV with **V-AUX**, you can change Library to TV.

- 1 Repeat steps 1 and 2 of the procedure in “Setting the manufacturer code”.
- 2 Select a Library (component category) by using ◀▶. There are 13 Libraries to set up a manufacturer code; L:AMP, L:TV, L:CAB (CABLE), L:DBS, L:SAT, L:VCR, L:DVD, L:LD, L:CD, L:CDR (CD-R), L:MD, L:TAP (TAPE), L:TUN (TUNER).

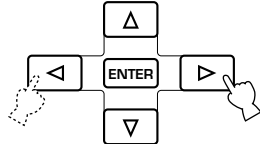

- 3 Repeat steps 3 and 4 of the procedure in “Setting the manufacturer code”.

Amplifier Library (L:AMP)

The code to operate this unit has been preset in the supplied remote control. However you can change the code in Amplifier Library if necessary.

Amplifier Library has the following three codes;

- YPC:** Code to operate this unit
- DSP:** Code to operate other Yamaha DSP amplifiers that cannot be operated with the YPC code
- No:** Code to operate other manufacturers’ amplifier using this unit’s remote control

Factory setting for Library and manufacturer

Input area	Component category (Library)	Manufacturer
V-AUX	VCR	—
TUNER	TUN	YAMAHA
PHONO	TV	—
CABLE	CAB	—
SAT	SAT	—
MD/TAPE	MD	YAMAHA
CD-R	CDR	YAMAHA
CD	CD	YAMAHA
D-TV/LD	TV	—
VCR1	VCR	—
VCR2	VCR	—
VCR3/DVR	VCR	—
DVD	DVD	YAMAHA

Programming a new remote control function (Learn feature)

If you want to program functions not included in the basic operations covered by the manufacturer code, or a manufacturer code is not available, the following procedure needs to be performed. The possible programming area is the same as a component control area, so the buttons are programmable independently for each source component area.

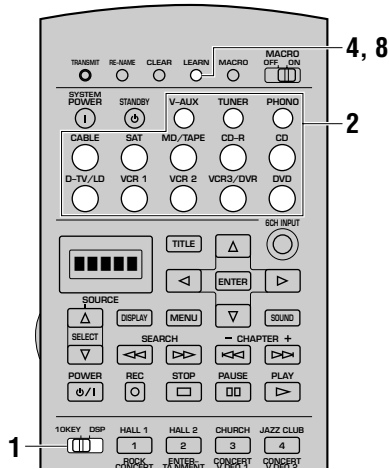

1 Set 10KEY/DSP to 10KEY.

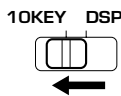

Caution

- It is also possible to program in the control area of this unit with **10KEY/DSP** set to DSP. However, if you program functions in this area, you cannot control this unit and select a DSP program.

2 Press an input selector button to select a source component.

3 Place this remote control and the other remote control about 5 to 10 cm apart on a flat surface so that their infrared transmitters are aimed at each other.

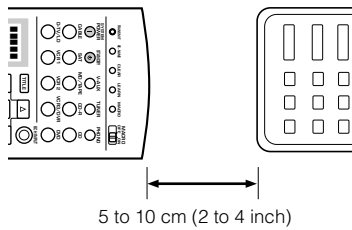

4 Press LEARN by using a ballpoint pen or similar object.

“LEARN” and the selected component name appear alternately in the display window.

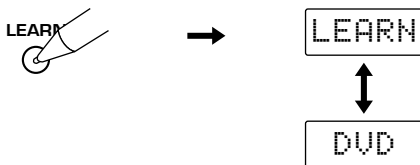

Cautions

- If you do not press any button within 30 seconds during steps 5 and 6, the learning process is canceled. If this happens, start over from step 4.
- Do not press and hold **LEARN** longer than 3 seconds. Otherwise this unit enters the manufacturer code setting mode.

5 Press the button for which you want to program the new function.

“LEARN” is displayed.

6 Press and hold the button on the other remote control that has the function you want to program into this remote control until “OK” appears in the display window.

Cautions

- “NG” appears in the display window when programming has not been done correctly. In this case, start over from step 5.
- When the memory is full, “FULL” appears in the display window, and this remote control cannot acquire any more functions. Clear unnecessary programmed functions to allow the unit to acquire new functions.

7 Repeat steps 5 and 6 to program additional functions.

8 Press LEARN again to exit from the learning mode.



Cautions

- Learning may not be possible in the following cases:
 - ① when the batteries in the remote control for this unit or other component are weak
 - ② when the distance between the two remote controls is too much or too little
 - ③ when the remote control infrared windows are not facing with appropriate angle
 - ④ when the remote control is exposed to the direct sunlight
 - ⑤ when the function to be programmed is continuous or uncommon
- “ERROR” appears in the display window in the following circumstances:
 - ① when pressing more than one button at once
 - ② when **MACRO ON/OFF** is switched to another position

■ Programmable buttons

The shaded area shown below shows the buttons can be used for programming (Learn) for each component selected by the input selector button.

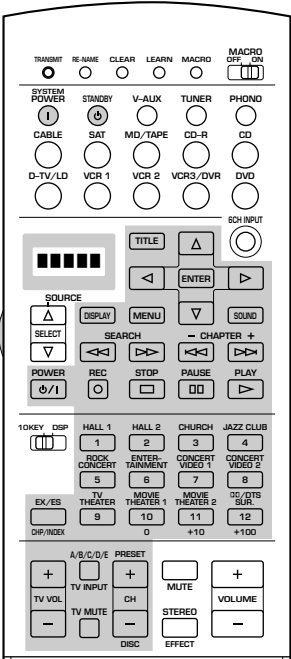

Each component control area

The general operational buttons are shown for each area. Some of them may not function depending on the component you have. After setting the manufacturer code, press an input selector button, or **SOURCE SELECT** Δ/∇ to select a component you want to control.

Caution

- “Yamaha” is factory-set in **TUNER**, **CD**, **CD-R**, **MD**, and **DVD** for their manufacturer code. It is necessary to change the manufacturer code if you would like to use the other manufacturers’ component. For other components than the ones listed above, you need to change the component category (Library) and then set the manufacturer code. See “Setting the manufacturer code” on pages 66 and 67 for details.

■ Operating a tuner (TUNER area)

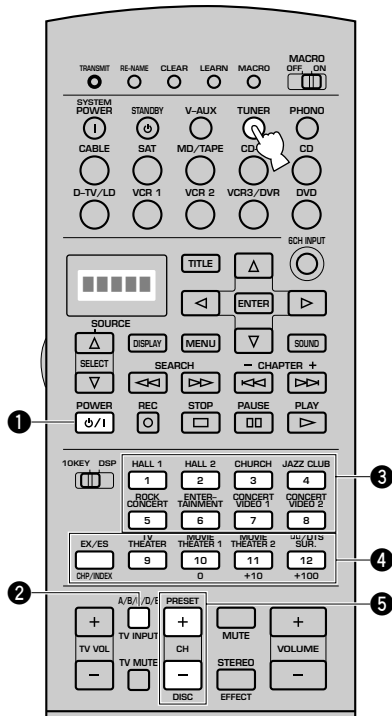

Operation example

- 1 POWER**
- 2 Preset group A/B/C/D/E**
- 3 Preset number 1 to 8**
- 4 Preset group A through E from left**
- 5 PRESET +/-**

■ Operating a CD player/CD recorder (CD and CD-R areas)

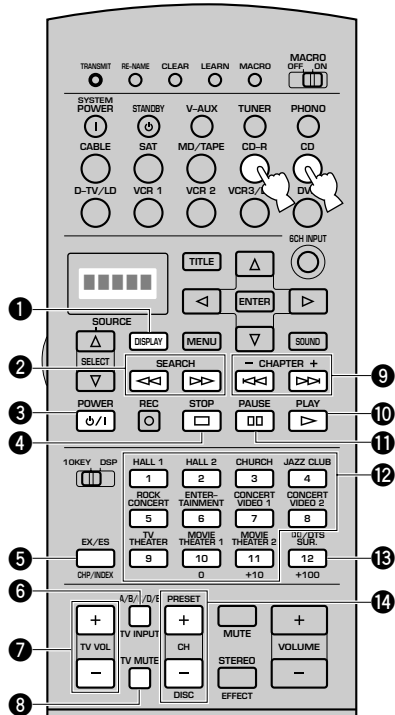

Operation example

- 1 DISPLAY
- 2 SEARCH
- 3 POWER
- 4 STOP
- 5 INDEX
- 6 TV INPUT *
- 7 TV VOL +/- *
- 8 TV MUTE *
- 9 Skip
- 10 PLAY
- 11 PAUSE
- 12 Numeric buttons
- 13 Clear
- 14 DISC +/- (disc skip)

Note

• For a Yamaha CD player, if you press or once, it pauses. It stops if pressed again.

* **TV VOL +/-**, **TV INPUT**, and **TV MUTE** function to operate your TV without switching the input if the manufacturer code is set in **D-TV/LD** or **PHONO**.

■ Operating an MD recorder (MD/TAPE area)

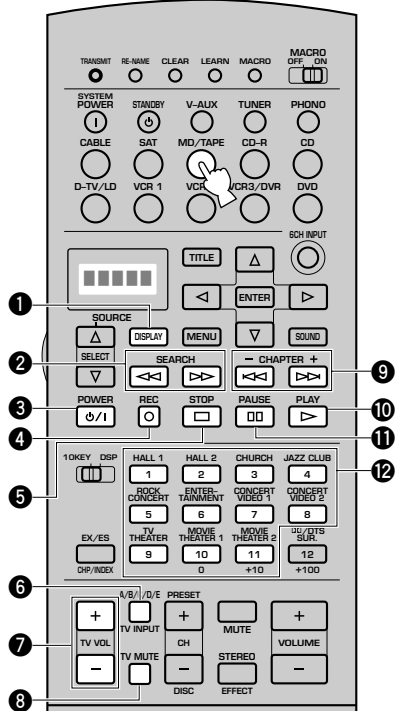

Operation example

- 1 DISPLAY
- 2 SEARCH
- 3 POWER
- 4 REC
- 5 STOP
- 6 TV INPUT *
- 7 TV VOL +/- *
- 8 TV MUTE
- 9 Skip
- 10 PLAY
- 11 PAUSE
- 12 Numeric buttons

* **TV VOL +/-**, **TV INPUT**, and **TV MUTE** function to operate your TV without switching the input if the manufacturer code is set in **D-TV/LD** or **PHONO**.

REMOTE CONTROL FEATURES

■ Operating a DVD player (DVD area)

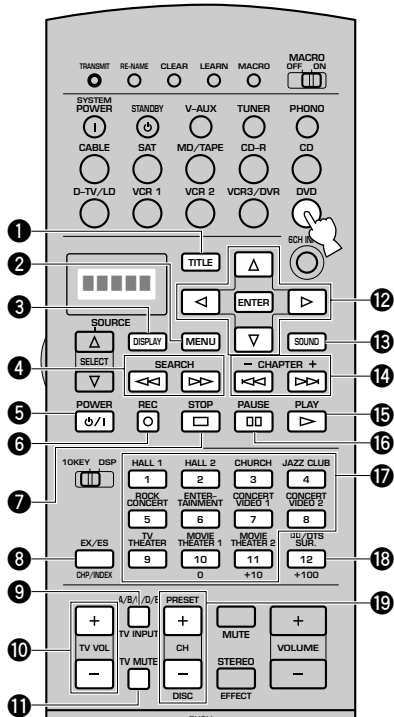

Operation example

- 1 TITLE
- 2 MENU
- 3 DISPLAY
- 4 SEARCH
- 5 POWER
- 6 Return
- 7 STOP
- 8 Title/Index
- 9 TV INPUT *
- 10 TV VOL +/- *
- 11 TV MUTE *
- 12 Menu cursor/ENTER
- 13 Audio
- 14 Skip
- 15 PLAY
- 16 PAUSE
- 17 Numeric buttons
- 18 Clear
- 19 DISC +/- (disc skip)

* TV VOL +/-, TV INPUT, and TV MUTE function to operate your TV without switching the input if the manufacturer code is set in **D-TV/LD** or **PHONO**.

■ Operating an LD player (D-TV/LD area)

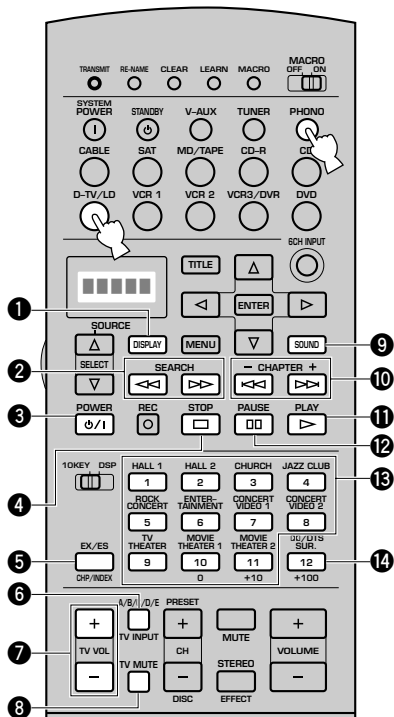

Operation example

- 1 DISPLAY
- 2 SEARCH
- 3 POWER
- 4 STOP
- 5 Chapter/Time
- 6 TV INPUT *
- 7 TV VOL +/- *
- 8 TV MUTE *
- 9 SOUND
- 10 CHAPTER +/-
- 11 PLAY
- 12 PAUSE
- 13 Numeric buttons
- 14 Clear

* TV VOL +/-, TV INPUT, and TV MUTE function to operate your TV without switching the input if the manufacturer code is set in **D-TV/LD** or **PHONO**.

■ Operating a VCR (VCR 1, VCR 2 and VCR3/DVR areas)

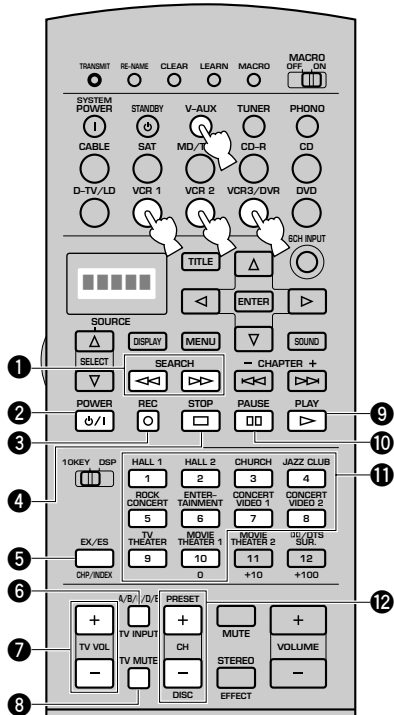

Operation example

- 1 SEARCH
- 2 POWER
- 3 REC (Press twice to start recording)
- 4 STOP
- 5 TV/Video input
- 6 TV INPUT *
- 7 TV VOL +/- *
- 8 TV MUTE *
- 9 PLAY
- 10 PAUSE
- 11 Numeric buttons
- 12 CH +/- (channel)

Note

• If more than two manufacturer codes for your VCRs are set up in any of the **V-AUX**, **VCR 1**, **VCR 2** and **VCR3/DVR** respectively, the only VCR whose manufacturer code is set up in the **VCR 1** area can be operated in the other components' operation mode.

* **TV VOL +/-**, **TV INPUT**, and **TV MUTE** function to operate your TV without switching the input if the manufacturer code is set in **D-TV/LD** or **PHONO**.

■ Operating a TV/digital TV (D-TV/LD area)

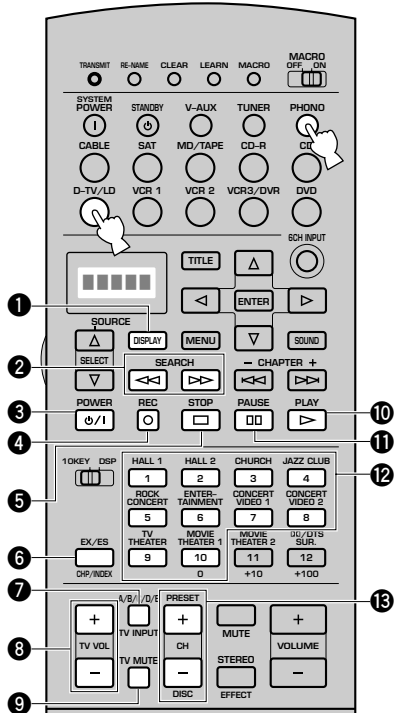

Operation example

- 1 DISPLAY
- 2 SEARCH *
- 3 POWER
- 4 REC (Press twice to start recording) *
- 5 STOP *
- 6 Enter
- 7 TV INPUT
- 8 TV VOL +/-
- 9 TV MUTE
- 10 PLAY *
- 11 PAUSE *
- 12 Numeric buttons
- 13 CH +/- (channel)

Note

• If two manufacturer codes for your TVs are set up in **PHONO** and **D-TV/LD**, the only TV whose manufacturer code is set up in the **D-TV/LD** area can be operated in the other components' operation mode.

* **SEARCH**, **REC**, **STOP**, **PAUSE** and **PLAY** function to operate your VCR without switching the input to **VCR 1** if the manufacturer code is set in **VCR 1**.

■ Operating a cable or satellite TV tuner (CABLE and SAT areas)

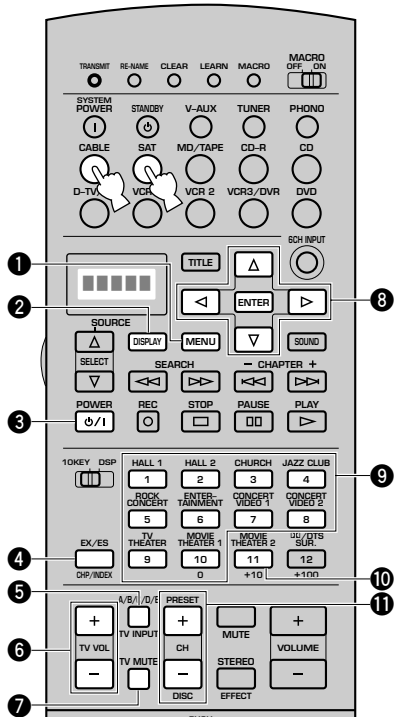

Operation example

- 1 MENU
- 2 DISPLAY
- 3 POWER
- 4 Enter
- 5 TV INPUT *
- 6 TV VOL +/- *
- 7 TV MUTE *
- 8 Menu cursor/ENTER
- 9 Numeric buttons
- 10 Recall
- 11 CH +/- (channel)

* TV VOL +/-, TV INPUT, and TV MUTE function to operate your TV without switching the input if the manufacturer code is set in **D-TV/LD** or **PHONO**.

Using the Macro feature

The Macro feature makes it possible to perform a series of operations by pressing just one button. For example, when you want to play a CD, normally you would turn on the components, select the CD input, and press the play button to start playback. The Macro feature lets you perform all those operations by simply pressing the CD macro button. The macro buttons (the input selector buttons, **SYSTEM POWER** and **STANDBY**) are factory set with macro programs. You can also program your own macros (see pages 76 and 77).

Macro buttons	First	Second	Third
SYSTEM POWER	This unit turns on. (The components connected to this unit turn on.) * ¹	TV turns on. (the TV whose manufacturer code is set up in the D-TV/LD area) * ²	—
STANDBY	This unit enters the standby mode.	—	—
V-AUX	This unit turns on. (The components connected to this unit turn on.) * ¹	Input source is selected. (V-AUX)	—
TUNER		Input source is selected. (TUNER) * ⁴	—
PHONO		Input source is selected. (PHONO)	—
CABLE		Input source is selected. (CABLE)	—
SAT		Input source is selected. (SAT)	—
MD/TAPE		Input source is selected. (MD/TAPE)	Playback of MD/TAPE starts. * ³
CD-R		Input source is selected. (CD-R)	Playback of CD-R starts. * ³
CD		Input source is selected. (CD)	Playback of CD starts. * ³
D-TV/LD		Input source is selected. (D-TV/LD)	—
VCR1		Input source is selected. (VCR1)	Playback of VCR 1 starts.
VCR2		Input source is selected. (VCR2)	Playback of VCR 2 starts. * ³
VCR3/DVR		Input source is selected. (VCR3/DVR)	Playback of VCR3/DVR starts. * ³
DVD		Input source is selected. (DVD)	Playback of DVD starts. * ³

*¹ In order to turn on some components (including YAMAHA components) connected to this unit, connect those components to the **AC OUTLET(S)** on the rear panel. (Power control may not be synchronized with this unit depending on the component. For details, please refer to the operation instruction for the connected component.)

*² If the macro you select includes power control functions, the component may be turned off if it is already on when you press the macro button. For example, if your TV is on and you press the **SYSTEM POWER** macro button, the TV is turned off.

*³ Playback can be started with any YAMAHA remote control-compatible MD recorders, CD players, CD recorders and DVD players. When using macros to operate other components, it is either necessary to program **PLAY** on the control area of that component (see pages 68 and 69) or to set up a manufacturer code (see page 66).

*⁴ When **TUNER** is selected as the input source, this unit receives the last station when this unit is set in the standby mode.

■ Operating the macro

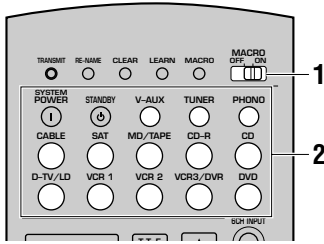

1 Set MACRO ON/OFF to ON.



2 Press a macro button.

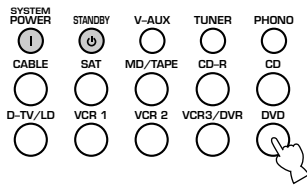

Cautions

- When you have finished using the Macro feature, set **MACRO ON/OFF** to OFF.
- While this unit is carrying out a macro program, this unit does not receive any other button's function until the macro operation has been completed (the **TRANSMIT** indicator stops flashing).
- Continue to aim the remote control at the component the macro is operating until the macro operation has been completed.

■ Programming a macro

You can program your own macros and use the Macro feature to transmit many remote control commands by pressing a single button.

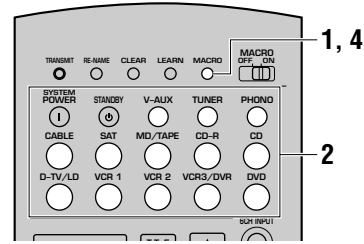

Cautions

- The factory-set macro is not cleared when a new macro is programmed for a button. The factory-set macro can be used again when the programmed macro is cleared.
- It is not possible to add a new signal (macro step) to the factory-set macro. Programming a macro changes all macro contents.
- A macro programming is used to transmit learning or setup (or YAMAHA preset) button signals of this remote control to a macro button. If necessary, set up the manufacturer code or program a function with the remote control for your component.
- This remote control handles button signals that operate continuously, such as volume control, as short time interval codes. Macro programming that include these types of macro steps are therefore not recommended.

1 Press **MACRO** by using a ballpoint pen or similar object.

"MCR ?" appears in the display window.



Caution

- If you do not press any button within 30 seconds during steps 2 and 3, the macro programming process is canceled. If this happens, start over from step 1.

2 Press a macro button for which you want to program the macro operation.

The button you chose for programming the macro operation and the selected component name appear alternately in the display window.

Example: Programming a macro for DVD

"M:DVD" and "DVD" appear alternately.

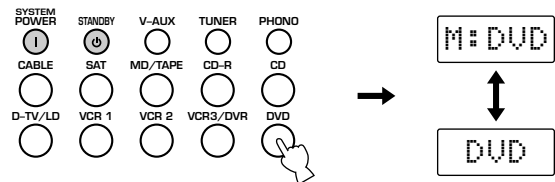

Cautions

- “AGAIN” appears in the display window when a button other than the macro buttons is pressed.
- If you want to change the source component, use **SOURCE SELECT** Δ/∇ or input selector buttons. When you use the input selector buttons, selecting the input is programmed as a macro step, whereas **SOURCE SELECT** Δ/∇ only changes the component.

3 Press the buttons of the functions that you want to include in the macro operation sequence in order.

You can set up to 10 steps (10 functions). After you have set 10 steps, “FULL” appears and the remote control automatically exits from the macro mode.

Example: Programming a macro for DVD

If the button that you want to program as the first macro step is pressed, “MCR 1” appears. In a few seconds, “M:DVD” and “DVD” appear and you can program the next button.

Caution

- “NG” appears in the display window when programming has not been done correctly. In this case, start over from step 2.

4 Press MACRO again when the operation sequence you want to program is complete.



Caution

- “ERROR” appears in the display window under the following circumstances:
 - ① when pressing more than one button at once
 - ② when **MACRO ON/OFF** is switched to another position

Changing the source name in the display window

You can change the name that appears in the display window on the remote control if you want to use the different name from the original input selector button names. This is useful when different component is set in the input selector button.

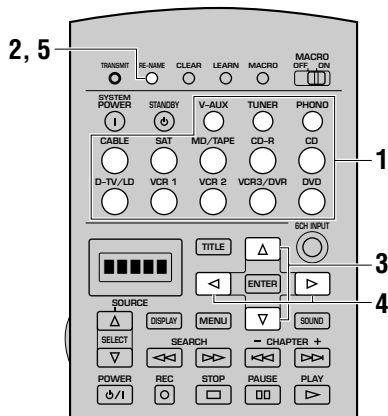

- 1 Press an input selector button to select the source component you want to rename.

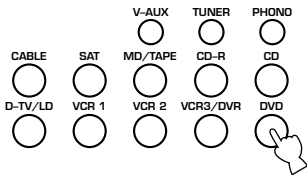

- 2 Press RE-NAME by using a ballpoint pen or similar object.

The cursor flashes on the left end.



- 3 Press Δ/∇ to select and enter a character.

You can use any of capital and lower case letters of the alphabet (A – Z and a – z), numbers (0 – 9), / (slash) and - (hyphen).

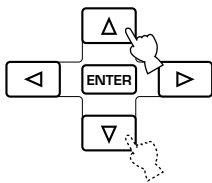

- 4 Press \leftarrow/\rightarrow to move the cursor to the next position.

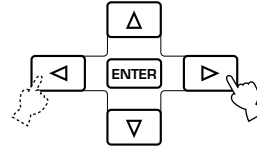

Repeat steps 3 and 4 if necessary. Up to five characters can be entered at maximum.

Note

- If you continuously want to rename another source component, press **ENTER** and repeat steps 1, 3 and 4.

- 5 Press RE-NAME again to exit from the renaming mode.



Clearing a learned function or macro

■ To clear a learned function

- 1 Press an input selector button to select the source component you want to clear the function.
- 2 Press **LEARN** by using a ballpoint pen or similar object.
“LEARN” and the selected component name appear alternately in the display window.

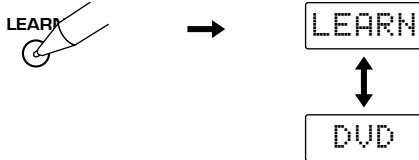

Caution

- If you do not press any button within 30 seconds after step 2, the clearing process is canceled. If this happens, start over from step 2.

- 3 Press the button that you want to clear for 3 seconds as pressing **CLEAR** by using a ballpoint pen or similar object.

“C:OK” appears in the display window.



Caution

- “C:NG” appears in the display window if the operation is unsuccessful. In this case, try step 3 again.

Note

- You can clear other learned functions at this time by holding down **CLEAR** again and pressing the other buttons for which those learned functions have been programmed.

- 4 Press **LEARN** again to exit from the clearing mode.

Once you have cleared a learned function for a button, the button reverts to the factory setting.



■ To clear the macro function

- 1 Press an input selector button to select the source component for which you want to clear the function.
- 2 Press **MACRO** to clear a programmed macro by using a ballpoint pen or similar object.



Caution

- If you do not press any button within 30 seconds after step 2, the clearing process is canceled. If this happens, start over from step 2.

- 3 Press and hold **CLEAR** by using a ballpoint pen or similar object, and at the same time press the button for which you want to clear the macro for about 3 seconds.

“C:OK” appears in the display window.



Caution

- “C:NG” appears in the display window if the operation is unsuccessful. In this case, try step 3 again.

Note

- You can clear other macros at this time by holding down **CLEAR** again and pressing the other buttons for which those macros have been programmed.

- 4 Press **MACRO** again to exit from the clearing mode.
Once you have cleared a macro for a button, the button reverts to the factory setting.



Clearing learned functions, macros, renamed source names, and setup manufacturer codes

You can reset the remote control to its factory setting by clearing the changed Libraries, programmed macros, set manufacturer codes and learned functions.

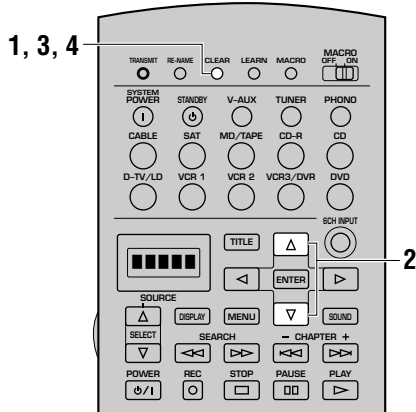

- 1 Press **CLEAR** by using a ballpoint pen or similar object.



Caution

- If you do not press any button within 30 seconds after step 1, the clearing process is canceled. If this happens, start over from step 1.

- 2 Press **Δ/∇** to select the clear mode.

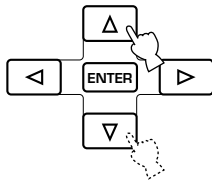

There are six clearing modes as shown below.

L:(name of a component) :

Clears all learned functions for the component area. Press the input selector button to select the component.

L:AMP : Clears all learned functions for this unit control area.

L:ALL : Clears all learned functions.

M:ALL : Clears all programmed macros.

RNAME : Clears all renamed source names in the display window.

FCTRY : Clears all programmed functions including setup manufacturer codes. This returns to the factory settings.

- 3 Press and hold **CLEAR** again for about 3 seconds. “C:OK” appears in the display window.



Caution

- “C:NG” appears in the display window if the operation is unsuccessful. In this case, start over from step 2.

- 4 Press **CLEAR** to exit from the clearing mode.

Once you have cleared a learned function or macro for a button, the button reverts to the factory setting.



Caution

- “ERROR” appears in the display window under the following circumstances:
 - ① when pressing a button other than the cursor and **ENTER**
 - ② when pressing more than one button at once
 - ③ when **MACRO ON/OFF**, **10KEY/DSP** or **PARAMETER/SET MENU** is switched to another position

ADJUSTING THE LEVELS OF THE EFFECT SPEAKERS

You can adjust the volume level of each effect speaker (center, right rear, rear center, left rear, front effect, and subwoofer) while listening to a music source.

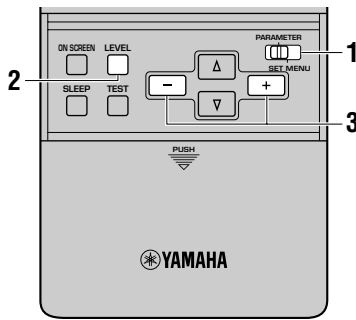

1 Set PARAMETER/SET MENU to PARAMETER.

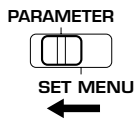

2 Press LEVEL to select the speaker(s) you want to adjust.

Each time you press this button the selected speaker changes and appears in the front panel display only as follows:

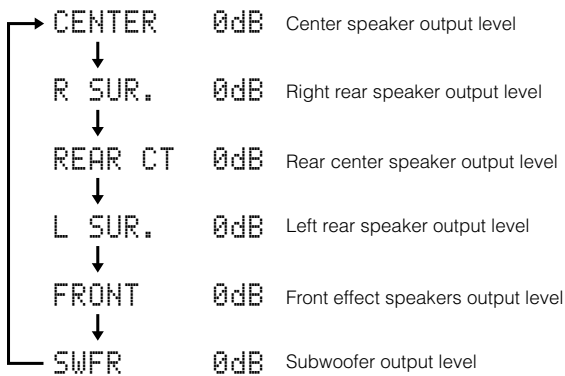

Note

- Once you press **LEVEL**, you can also select the speaker(s) to be adjusted by pressing Δ/∇ .

3 Press +/- to adjust the speaker output level.

- The control range for the center, left and right rear or rear center speakers is from +10 dB to -10 dB.
- The control range for the subwoofer is from -20 dB to 0 dB.

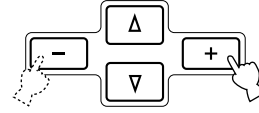

Cautions

- When you adjust the output level with **LEVEL**, the settings you made with the test tone will be changed.
- When **PARAMETER/SET MENU** is set to SET MENU, you cannot adjust the output level by using **LEVEL**. However, each time you press **LEVEL**, the current level of each speaker appears on the front panel display and you can check the speaker level.
- When the speaker output modes for “1A CENTER SP”, “1C REAR L/R SP”, “1D REAR CT SP” and “1F FRONT EFCT SP” are set to “NONE”, and “1E LFE/BASS OUT” to “MAIN”, the output level of those speakers cannot be adjusted because there is no sound coming from these speakers.

SLEEP TIMER

Use this feature to automatically set this unit in the standby mode after the amount of time you have set. The sleep timer is useful when you are going to sleep while this unit is playing or recording a source. The sleep timer also automatically turns off the external components connected to **AC OUTLET(S)**.

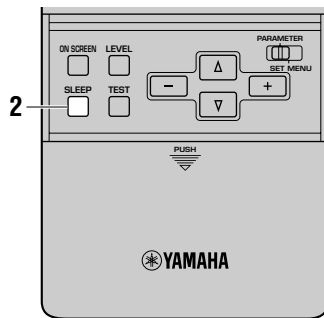

■ Canceling the sleep timer

Press **SLEEP** repeatedly until “SLEEP OFF” appears on the front panel display.

After a few seconds, “SLEEP OFF” disappears, the “SLEEP” indicator goes off and the display returns to the previous indication.

Note

- The sleep timer setting can also be canceled by setting this unit in the standby mode by using **STANDBY** on the remote control (or **STANDBY/ON** on the front panel) or by disconnecting the AC power cord from the AC outlet.

■ Setting the sleep timer

- 1 Select a source and start playback on the source component.
- 2 Press **SLEEP** repeatedly to set the amount of time.
Each time you press **SLEEP**, the front panel display changes as shown below.

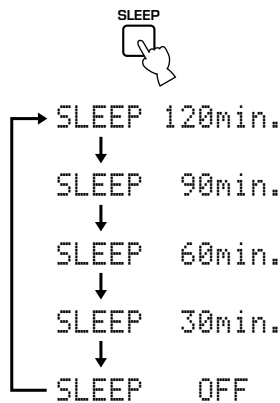

The “SLEEP” indicator soon lights up on the front panel display after the sleep timer has been set. The display then returns to the previous indication.

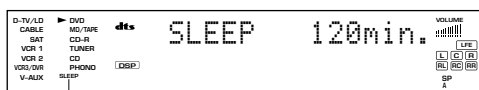

SLEEP indicator

ZONE 2

You can make up a multi-room audio-video system with this unit. With this feature, you can set this unit to reproduce separate input sources in the main room and second (Zone 2) room using the supplied remote control in the second room.

ONLY ANALOG SIGNALS ARE SENT TO THE SECOND ROOM. FOR ANY SOURCE YOU WISH TO LISTEN TO IN THE SECOND ROOM, YOU MUST CONNECT THE ANALOG OUTPUT FROM THE SOURCE TO THE CORRESPONDING ANALOG INPUT ON THIS UNIT.

Connections

To use the multi-room functions of this unit, you need the following additional equipment:

- An infrared signal receiver in the second room
- An infrared emitter in the main room
This emitter transmits the infrared signals from the remote control in the second room to the main room (for example, to a CD player or LD player).
- An amplifier and speakers for the second room
- A video monitor for the second room

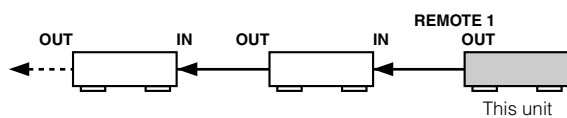

Cautions

- Since there are so many ways to connect and use this unit in a multi-room installation, we recommend that you consult with a custom installation specialist for the Zone 2 connections which will best meet your requirements.
- Some Yamaha models are able to connect directly to the **REMOTE 1 OUT** jacks of this unit. If you own these products, you may not need to use an infrared emitter. Up to six Yamaha components can be connected as shown.

■ A sample of system configuration and connections

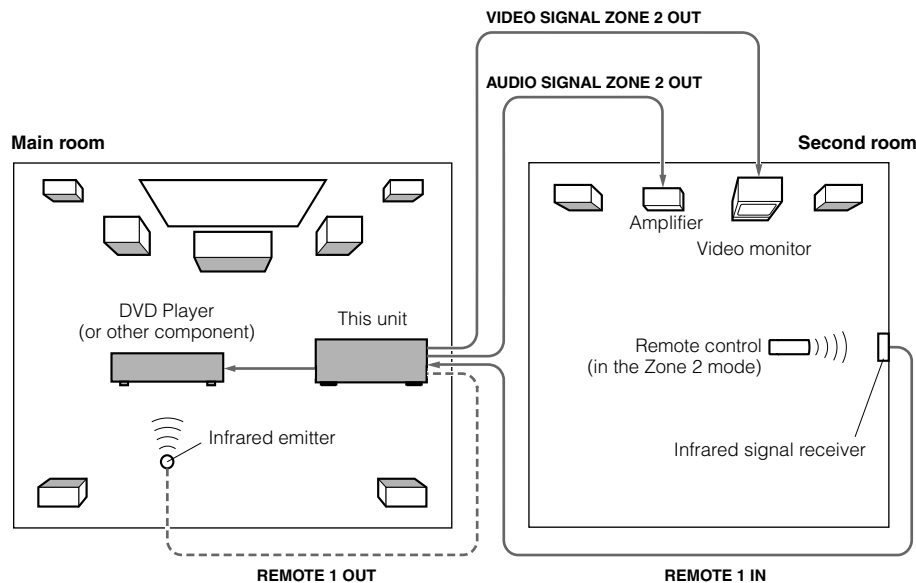

■ Special considerations when using DTS software

The DTS signal is a digital bitstream. Therefore, if you attempt to send the DTS signal to Zone 2, you will only be able to hear the digital noise that could damage your loudspeakers.

Due to this characteristic of DTS encoded discs, the following considerations and adjustments need to be made.

For DTS encoded LDs or DVDs

Only 2-channel audio signals may be sent to Zone 2. Set your Laser Disc/DVD player's left and right outputs to the analog sound track.

For DTS encoded compact discs

DO NOT USE the Zone 2 feature with DTS encoded compact discs.

Remote control in ZONE 2

In the second (Zone 2) room, the supplied remote control can be used as the Zone 2 remote control. You can select the input source and control the component which is located in the main room directly from the second room regardless of the listening condition in the main room.

- 1 Press **SOURCE SELECT** Δ to display “Zone2” in the display window.



- 2 Use the input selector buttons to select the input source you want to listen to.

The display window shows “2: name of selected input” if the remote control is in the Zone 2 mode.

Example: When DVD is selected

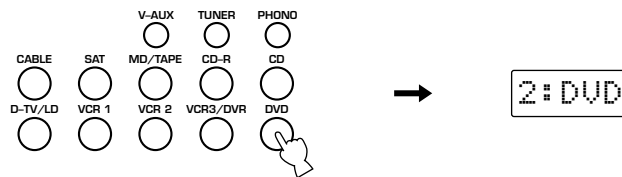

- 3 You can control the component using the component control area buttons.

Note

- **VOLUME +/-** can be used to adjust the volume if you set the SET MENU item “17 ZONE2 SET”, “ZONE2 OUT” to “VAR.” (see page 63).

Sound field programs

This section explains the sound field programs and its parameters.

DIGITAL SOUND FIELD PROCESSING (DSP)	86
Understanding sound fields	86
Recreating a sound field	87
Illustration of the virtual sound sources and echo patterns	87
HI-FI DSP-SOUND FIELD PROGRAM	88
Programs and features	88
CONCERT HALL 1	89
CONCERT HALL 2	89
CHURCH	89
JAZZ CLUB	89
ROCK CONCERT	89
ENTERTAINMENT	89
CINEMA-DSP SOUND FIELD PROGRAM	90
The sound design of CINEMA-DSP sound field programs	90
Sound field images of the CINEMA-DSP programs	90
Programs and features	91
MOVIE THEATER programs	93
ENTERTAINMENT	94
CONCERT VIDEO 1	94
CONCERT VIDEO 2	94
TV THEATER	94
MOVIE THEATER 1	94
MOVIE THEATER 2	94
DOLBY DIGITAL/DTS SURROUND	94
SOUND FIELD PROGRAM PARAMETER EDITING	95
Changing parameter settings	95
DIGITAL SOUND FIELD PARAMETER DESCRIPTIONS	96

DIGITAL SOUND FIELD PROCESSING (DSP)

Understanding sound fields



A sound field is defined as the “characteristic sound reflections of a particular space”. In concert halls and other music venues, we hear early reflections and reverberations as well as the direct sound produced by the artist(s). The variations in the early reflections and other reverberations among the different music venues is what gives each venue its special and recognizable sound quality.

Yamaha sent teams of sound engineers all around the world to measure the sound reflections of famous concert halls and music venues, and collect detailed sound field information such as the direction, strength, range, and delay time of those reflections. Then we stored this enormous amount of data in the ROM chips of this unit.

■ Early reflections

Reflected sounds reach our ears extremely rapidly (50 ms – 80 ms after the direct sound), after reflecting from one surface only — for example, from the ceiling or a wall. These reflections provide vital information to our ears. Early reflections actually add clarity to the direct sound.

■ Reverberations

These are caused by reflections from more than one surface — walls, ceiling, the back of the room — so numerous that they merge together to form a continuous sonic “afterglow”. They are non-directional, and lessen the clarity of the direct sound.

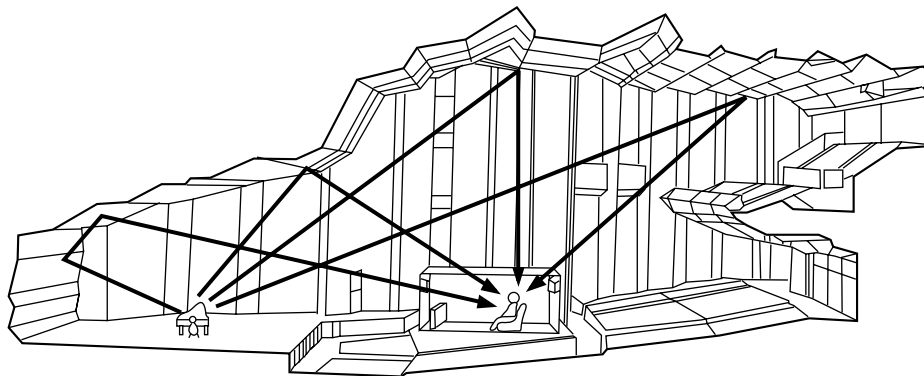

Reflected sounds image

Recreating a sound field

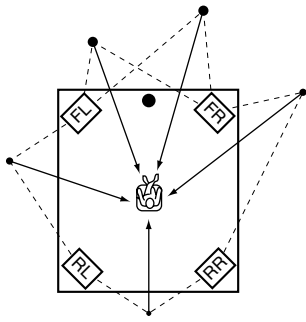

Recreating the sound field of a concert hall or an opera house requires localizing the virtual sound sources in your listening room. The traditional stereo system that uses only two speakers is not capable of recreating a realistic sound field. Yamaha's DSP requires four effect speakers to recreate sound fields based on the measured sound field data. The processor controls the strength and delay time of the signals output from the four effect speakers to localize the virtual sound sources in a full circle around the listener.

The DSP sound field programs can be classified in two types based on the sound field processing method: programs that use early reflections only and programs that use both early reflections and reverberation.

Illustration of the virtual sound sources and echo patterns

The virtual sound sources and echo patterns for the DSP sound field programs are shown below. The illustration of the virtual sound sources shows early reflection sound only and the illustration of the echo patterns shows both reflected sound and reverberation.

Virtual sound sources

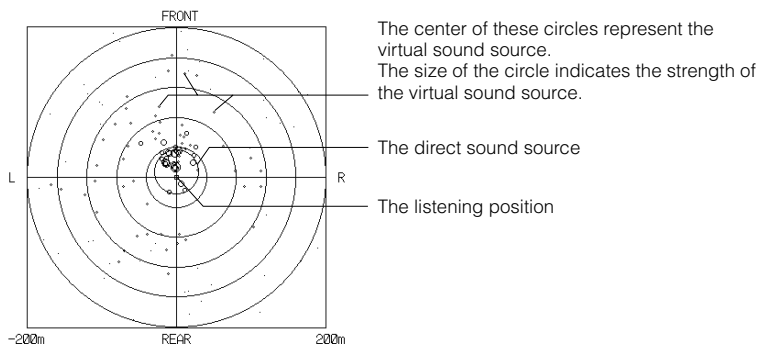

Echo patterns

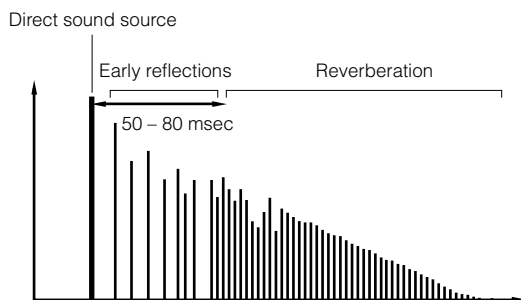

HI-FI DSP-SOUND FIELD PROGRAM

Programs and features

- These programs are the most suitable for the stereo music sources such as CDs.
- Sound field is created using four effect speakers (front L, front R, rear L and rear R) in addition to the main speakers.
- When “8ch Stereo” is selected, input signals are output from the all speakers that have been set on the SET MENU.
- Appropriate decoders automatically turn on depending on the input signals.

No.	Program	Features	
1	CONCERT HALL 1	Europe Hall A	A large fan-shaped concert hall
		Europe Hall B	A large shoe-box type concert hall that has a solid, powerful sound
		Europe Hall C	A classic shoe-box type concert hall that creates complex reflections for a full, rich sound
2	CONCERT HALL 2	U.S.A. Hall D	A large concert hall where the middle and high frequencies are richly and beautifully reinforced
		Europe Hall E	A large classic shoe-box type concert hall that produces rich sounds
		Live Concert	Near the center of a large round concert hall, where rich surround effect is produced
3	CHURCH	Tokyo	An ordinary church with moderate reverberations
		Freiburg	A church with a high ceiling that has the long reverberation delay
		Royaumont	The refectory (dining hall) of a beautiful medieval Gothic monastery
4	JAZZ CLUB	Village Gate	A famous New York jazz club that has with a spacious floor
		Village Vanguard	A traditional jazz club in New York
		The Bottom Line	A famous New York jazz club “The Bottom Line”
5	ROCK CONCERT	Roxy Theatre	LA’s “hottest” rock club
		Warehouse Loft	A concrete-built warehouse
		Arena	A classic shoe-box type concert hall that creates the spacious feel of a large arena
6	ENTERTAINMENT	Disco	High-energy, “hot” disco
		Party	For background music at home parties
		8ch Stereo	

Caution

- The sound field programs for this unit are designed based upon the detailed information that Yamaha sound engineers have collected by measuring the sound effect characteristics at the actual concert halls and music venues all over the world. Therefore you may find some difference in reverberation and volume of the sounds that are output from each of your speakers.

CONCERT HALL 1

■ Europe Hall A

This is a large fan-shaped concert hall in Munich which has approximately 2500 seats. Almost the whole interior is made of wood. There is relatively little reflection from the walls, and sound spreads finely and beautifully.

■ Europe Hall B

This is a large shoe-box type concert hall with less than 2400 seats located in Frankfurt. This hall has a very solid, powerful sound. The listener's virtual seat is in the center-right section on the first floor.

■ Europe Hall C

A classic shoe-box type concert hall with approximately 1700 seats. Pillars and ornate carvings create extremely complex reflections which produce a very full, rich sound.

CONCERT HALL 2

■ U.S.A. Hall D

This is a large 2600 seat concert hall in the United States which features a fairly traditional European design. The interior is relatively simple, in the American style. The middle and high frequencies are richly and beautifully reinforced.

■ Europe Hall E

This is a large 2200 seat shoe-box type concert hall in Amsterdam. It has a circular stage with seats located behind the stage.

■ Live Concert

A large round concert hall with a rich surround effect. Pronounced reflections from all directions emphasize the extension of sounds. The sound field has a great deal of presence, and your virtual seat is near the center, close to the stage.

CHURCH

■ Tokyo

The acoustic environment of an ordinary church with moderate reverberations. The reverberation lasts 2.5 seconds. This is ideal for reproducing church organ and choral music.

■ Freiburg

This program recreates the acoustic environment of a big church located in south Germany. The reverberation delay is very long while the early reflections are smaller than with other sound field programs.

■ Royaumont

This program features the sound field created by the refectory (dining hall) of a beautiful medieval Gothic monastery located in Royaumont on the outskirts of Paris.

JAZZ CLUB

■ Village Gate

This is the sound field at a jazz club in New York. It is in a basement and has a relatively spacious floor area. The listener's virtual seat is at the center left of the hall.

■ Village Vanguard

A traditional jazz club in New York, located on 7th Avenue. This room has a low ceiling, and the "stage" is located in a corner. This program creates an intimate "close-to-the music" feel.

■ The Bottom Line

This is the sound field at stage front in "The Bottom Line", a famous New York jazz club. The floor can seat 300 people to the left and right in a sound field offering a real and vibrant sound.

ROCK CONCERT

■ Roxy Theatre

The ideal program for lively, dynamic rock music. The data for this program was recorded at LA's "hottest" rock club. The listener's virtual seat is at the center-left of the hall.

■ Warehouse Loft

This program simulates a space enclosed by concrete. An energetic sound field is created with relatively clear reflections from the walls.

■ Arena

A classic shoe-box type concert hall. This program gives you long delays between direct sounds and effect sounds, with the extraordinarily spacious feel of a large arena.

ENTERTAINMENT

■ Disco

This program recreates the acoustic environment of a lively disco in the heart of a big city. The sound is dense and highly concentrated. It is also characterized by a high-energy, "immediate" sound.

■ Party

This is a sound field suitable for background music at parties where you can hear the sound directly from the rear as well, thus realizing music enjoyment over a wide area.

■ 8ch Stereo

This is a sound field suitable for background music at parties where you can hear the sound directly from the rear as well. The number of speakers to output depends on "1 SPEAKER SET" in SET MENU.

CINEMA-DSP SOUND FIELD PROGRAM

The sound design of CINEMA-DSP sound field programs

Filmmakers intend the dialog to be located right on the screen, the effect sound a little farther back, the music spread even farther back, and the surround sound around the listener. Of course, all of these sounds must be synchronized with the images on the screen.

CINEMA-DSP is an upgraded version of YAMAHA DSP specially designed for movie soundtracks. CINEMA-DSP integrates the DTS, Dolby Digital, and DOLBY PRO LOGIC surround sound technologies with YAMAHA DSP sound field programs to provide the surround sound field. It recreates the most complete movie sound design in your audio room. In CINEMA-DSP sound field programs, Yamaha's exclusive DSP processing is added to the front left, center, and right channels, so the listener can enjoy realistic dialogue, depth of sound, smooth transition between sound sources, and a surround sound field that goes beyond the screen.

When a DTS or Dolby Digital signal is detected, the CINEMA-DSP sound field processor automatically chooses the most suitable sound field program for that signal.

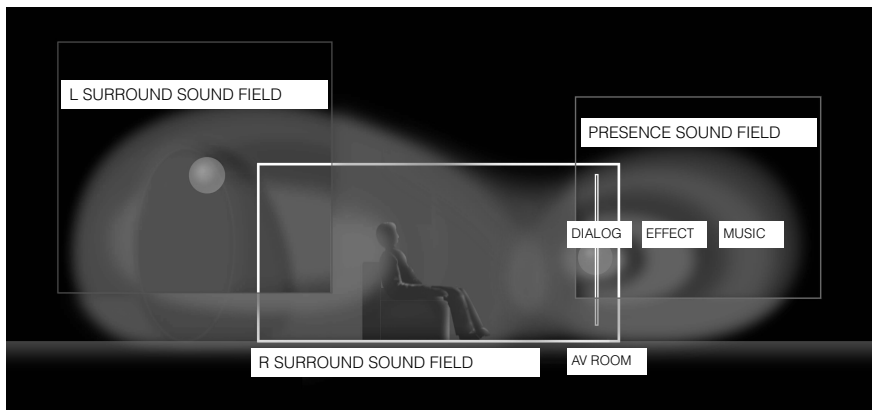

Sound field images of the CINEMA-DSP programs

Each CINEMA-DSP program has its own type of sound field processing block. The sound field data, including the presence and surround sound fields, are based on actual measured data. The presence and surround sound fields can be expressed in the distribution of virtual sound sources and echo patterns. However, as these two types of sound fields are processed with complex elements such as energy balance and mixing signal ratios, they are expressed as a sound field based on auditory perception.

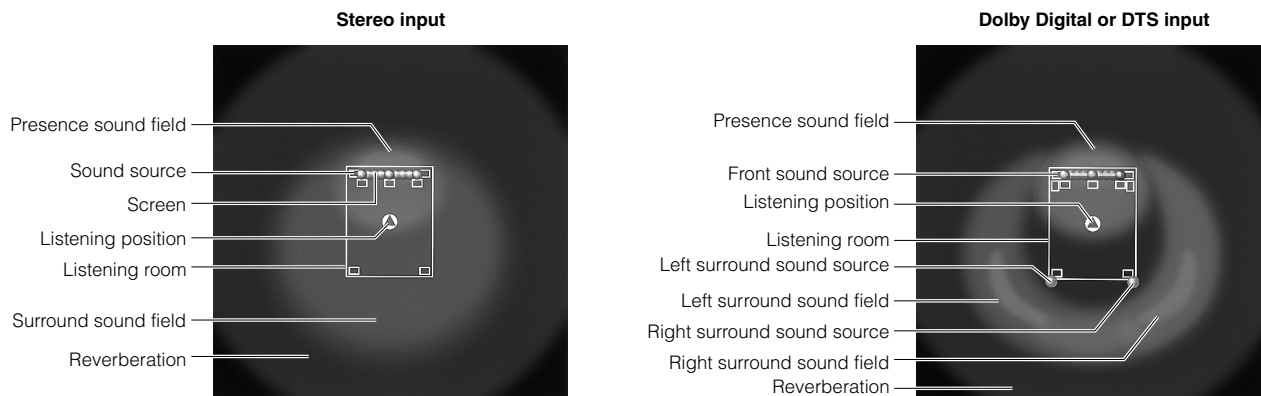

Programs and features

If a Dolby Digital signal or DTS signal is input when the input mode is set to "AUTO", the DSP program will be automatically switched to the Dolby Digital playback sound field or DTS playback sound field.

No.	Program		Features
6	ENTERTAINMENT	Game	A deep and spatial feeling to reinforce lively video game sounds
7	CONCERT VIDEO 1	Pop/Rock	An enthusiastic atmosphere of an actual rock or jazz concert
		DJ	Clearer voice of a disc jockey sound
8	CONCERT VIDEO 2	Classical/Opera	Great presence and beautiful sounds
		Pavilion	A feel of the spaciousness of a pavilion
9	TV THEATER	Mono Movie	Natural reproduction of old monaural movies with moderate DSP processing
		Variety/Sports	For various TV programs such as variety shows or sports programs
10	MOVIE THEATER 1	Spectacle	Ideal for any kind of Dolby Surround video sources, especially large-scale movie productions
		Sci-Fi	For the newest science fiction films
11	MOVIE THEATER 2	Adventure	Ideal for the newest 70 mm and multichannel soundtrack films
		General	Reproduction of sounds from 70 mm and multichannel soundtrack films with soft and extensive sound field
12	DOLBY DIGITAL/ DTS SURROUND	Normal/EX/DTS-ES/ ES Matrix 6.1/ES Discrete 6.1	To reproduce the Dolby Digital or DTS sources with excellent channel separation and stable decoding
		Enhanced/EX/ES	To add DSP effects to the Dolby Digital and DTS surround signals
	DOLBY PRO LOGIC	Normal	To reproduce 2 channel sources as creating virtual multichannels
		Enhanced	
	DOLBY PRO LOGIC II	Movie	
		Music	
	DTS Neo: 6	Cinema	
		Music	

Cautions

- The "[DSP]" indicator does not light up when selecting the program No. 12 except for the "Enhanced" mode.
- No sound will be output from the main speakers when a monaural source is played with sound field Program Groups 6 (Game) and 7 – 12.
- No surround signals will be output when a monaural source is played with the CINEMA DSP program No.12.

Table of program names for each input format

According to the input signal format, this unit automatically chooses the appropriate decoder and DSP sound field pattern.

No.	Input Program	2 channel	5.1 channel		6.1 channel *1	
		Stereo	DOLBY DIGITAL	DTS	DOLBY DIGITAL EX *2	DTS ES *3
10	MOVIE THEATER 1	70 mm Spectacle	DGTL Spectacle	DTS Spectacle	Spectacle EX	Spectacle ES
		70 mm Sci-Fi	DGTL Sci-Fi	DTS Sci-Fi	Sci-Fi EX	Sci-Fi ES
11	MOVIE THEATER 2	70 mm Adventure	DGTL Adventure	DTS Adventure	Adventure EX	Adventure ES
		70 mm General	DGTL General	DTS General	General EX	General ES
12	DOLBY DIGITAL	—	Normal	—	EX	—
		—	Enhanced	—	Enhanced EX	—
	DTS DIGITAL SUR	—	—	Normal 96/24 Normal *6	—	ES Matrix 6.1 *4 ES Discrete 6.1 *5 96/24 DTS-ES *6
		—	—	Enhanced	—	Enhanced ES
	PRO LOGIC	Normal	—	—	—	—
		Enhanced	—	—	—	—
	PRO LOGIC II	Movie	—	—	—	—
		Music	—	—	—	—
	DTS Neo: 6	Cinema	—	—	—	—
		Music	—	—	—	—

*1 means the EX/ES decoder is ON.

*2 means the DOLBY DIGITAL EX software is input.

*3 means the DTS ES software is input.

*4 means the DTS ES software encoded with Matrix 6.1 is input.

*5 means the DTS ES software encoded with Discrete 6.1 is input.

*6 means the DTS 96/24 software is input.

MOVIE THEATER programs

Most movie software has four-channel (left, center, right and surround) sound information encoded using Dolby Surround matrix processing and stored on the left and right tracks. These signals are processed by the DOLBY PRO LOGIC decoder. The MOVIE THEATER programs are designed to recreate the spaciousness and delicate nuances of sound that tend to be lost in the encoding and decoding processes.

The six-channel soundtracks found on 70 mm film produce precise sound field localization and rich, deep sound without using matrix processing. This unit's MOVIE THEATER 70 mm Programs provide the same quality of sound and sound localization that six-channel soundtracks do. The built-in Dolby Digital decoder brings the professional quality sound designed for movie theaters into your home. With this unit's MOVIE THEATER program, you can recreate a dynamic sound that gives you the feeling of being at a public theater in your living room using the Dolby Digital technology.

■ DOLBY PRO LOGIC + DSP sound field effect

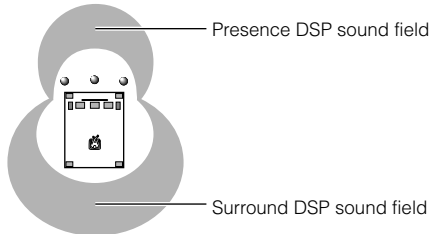

These programs express an immense sound field and a large surround effect. They also give depth to the sound from the main speakers to recreate the realistic sound of a Dolby Stereo theater.

- 70mm Spectacle
- 70mm Sci-Fi
- 70mm Adventure
- 70mm General

■ Dolby Digital/DTS + DSP sound field effect

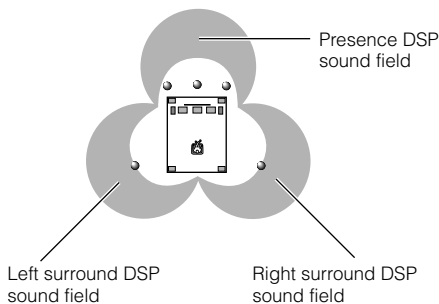

These programs use Yamaha's tri-field DSP process on each of the Dolby Digital or DTS signals for the front, left surround, and right surround channels. This processing enables this unit to reproduce the immense sound field and surround expression of a Dolby Digital or DTS equipped movie theater without sacrificing the clear separation of all channels.

- DGTL/DTS Spectacle
- DGTL/DTS Sci-Fi
- DGTL/DTS Adventure
- DGTL/DTS General

Note

- If a Dolby Digital signal or DTS signal is input when the input mode is set to "AUTO", the DSP program will be automatically switched to the Dolby Digital playback sound field or DTS playback sound field.

■ Dolby Digital EX/DTS ES + DSP sound field effect

These programs provide you the maximum experience of the spacious surround effects since an extra rear center DSP sound field created from the rear center channel is added.

ENTERTAINMENT

■ Game

This program adds a deep and spatial feeling to video game sounds and is also suitable for karaoke.

CONCERT VIDEO 1

■ Pop/Rock

This program produces an enthusiastic atmosphere and lets you feel as if you are at an actual jazz or rock concert.

■ DJ

The sound field makes the voice of a disc jockey sound clearer.

CONCERT VIDEO 2

■ Classical/Opera

This program provides excellent vocal depth and overall clarity by restraining excessive reverberation.

The surround sound field is relatively moderate but it reproduces beautiful sound using data collected from a concert hall.

■ Pavilion

This program reproduces vocals clearly, letting you feel the spaciousness of a pavilion. Reverberation, which is somewhat delayed, reproduces the live acoustics unique to a pavilion, and helps to make concert scenes more exciting.

TV THEATER

■ Mono Movie

This program is provided for reproducing monaural video sources (such as old movies). The program produces the optimum reverberation to create sound depth using only the presence sound field.

■ Variety/Sports

Though the presence sound field is relatively narrow, the surround sound field employs the sound environment of a large concert hall. With this program, you can enjoy watching various TV programs such as news, variety shows, music programs or sports programs.

MOVIE THEATER 1

■ Spectacle

This program creates the extremely wide sound field of a 70 mm movie theater. It precisely reproduces the source sound in detail, making both the video and the sound fields incredibly real. This program is ideal for any kind of Dolby Surround video source (especially large-scale movie productions).

■ Sci-Fi

This program clearly reproduces the broad and expansive cinematic space from the soundtracks of the latest science fiction films.

MOVIE THEATER 2

■ Adventure

This program is ideal for precisely reproducing the sound design of the newest 70 mm and multichannel soundtrack films. The sound field is made to be similar to that of the newest movie theaters, so the reverberations of the sound field itself are restrained as much as possible.

■ General

This program is for reproducing sounds from 70 mm and multichannel soundtrack films, and is characterized by a soft and extensive sound field. The presence sound field is relatively narrow. It spatially spreads all around and toward the screen, restraining the effect of conversations without losing clarity.

DOLBY DIGITAL/DTS SURROUND

■ Normal/EX/DTS-ES/ES Matrix 6.1/ES Discrete 6.1

The built-in decoder precisely reproduces sounds and sound effects from sources. The highly efficient decoding process improves crosstalk and channel separation and makes sound positioning smoother and more precise.

In this program, no DSP effect is applied.

■ Enhanced/EX/ES

This program ideally simulates the multiple surround speaker systems of 35 mm film theaters. The Dolby Surround decoding and the digital sound field processing create precise effects without altering the original sound orientation. The surround effects produced by this sound field wrap around the viewer naturally from the back to the left and right and toward the screen.

SOUND FIELD PROGRAM PARAMETER EDITING

You can enjoy good quality sound with the preset parameters. Although you do not have to change the initial settings, you can change some of the parameters to better suit the input source or your listening room.

Changing parameter settings

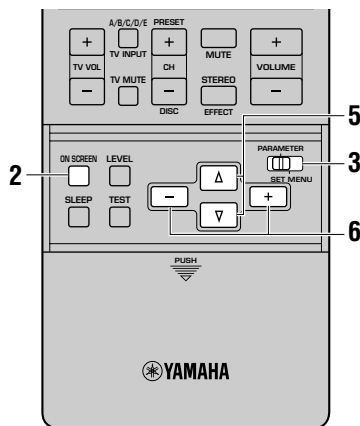

- 1 Turn on the video monitor.
- 2 Press ON SCREEN repeatedly to select the full display mode.



- 3 Set PARAMETER/SET MENU to PARAMETER.

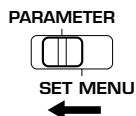

- 4 Select a DSP program you want to adjust.

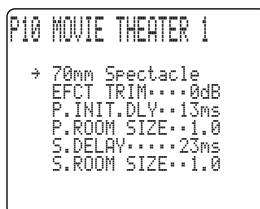

- 5 Press Δ/∇ to select the parameter.

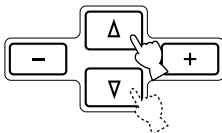

- 6 Press +/- to change the parameter value.
When you set the parameter to a value other than the factory-set value, an asterisk mark (*) appears by the parameter name on the video monitor.

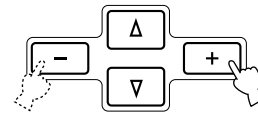

- 7 Repeat steps 4 to 6 above as necessary to change other program parameters.

Cautions

- The available parameters may be displayed on more than one OSD page for some of the programs. To scroll through pages, press Δ/∇ .
- You cannot change parameter values when “16 MEMORY GUARD” on the SET MENU is set to “ON”. If you want to change the parameter values, set “16 MEMORY GUARD” to “OFF” (see page 62).

■ To reset some of the parameters to the factory-set values

Select the parameter you want to reset. Then press and hold +/- until the value temporarily stops at the factory-set value. The asterisk mark (*) by the parameter name disappears on the video monitor.

■ To reset all of the parameters to the factory-set values

Use “10 PARAMETER INI” on the SET MENU to reset all of the parameter values of all DSP programs within the selected group to the factory-set values (see page 59). This operation resets all of the parameter values of all DSP programs within that group to the factory-set values.

DIGITAL SOUND FIELD PARAMETER DESCRIPTIONS

You can adjust the values of certain digital sound field parameters so the sound fields are recreated accurately in your listening room. Not all of the following parameters are found in every program.

■ EFCT TRIM (Effect Trim)

Function This parameter adjusts the level of all the effect sounds within a narrow range.

Control range -3 dB - +3 dB

Description Depending on the acoustics of your listening room, you may want to increase or decrease the effect level relative to the direct sound.

■ INIT. DLY (Initial Delay)

Function This parameter changes the apparent distance from the source sound by adjusting the delay between the direct sound and the first reflection heard by the listener.

Control range 1 - 99 ms

Description The smaller the value, the closer the sound source seems to the listener. The larger the value, the farther the apparent distance seems. For a small room, this parameter would be set to a small value, for a large room, set it to a large value.

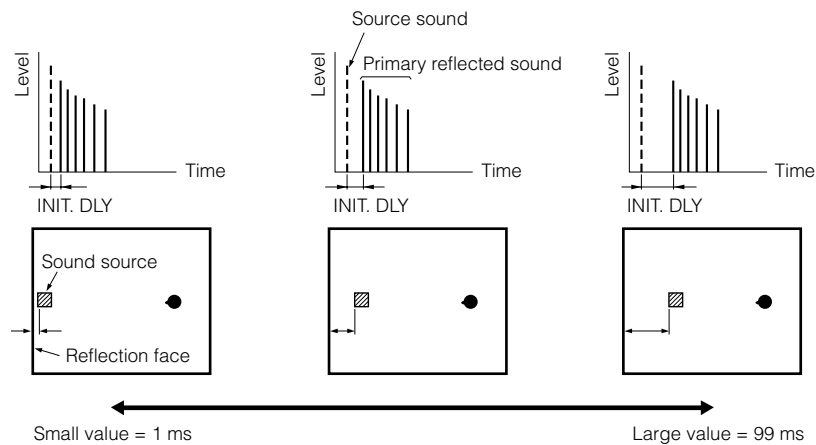

■ ROOM SIZE/P. ROOM SIZE for the presence sound field

Function This parameter adjusts the apparent size of the surround sound field. The larger the value, the larger the surround sound field becomes.

Control range 0.1 - 2.0

Description As the sound is repeatedly reflected around a room, the larger the hall is, the longer the time between the original reflected sound and the subsequent reflections. By controlling the time between the reflected sounds, you can change the apparent size of the virtual venue. Changing this parameter from one to two, doubles the apparent length of the room.

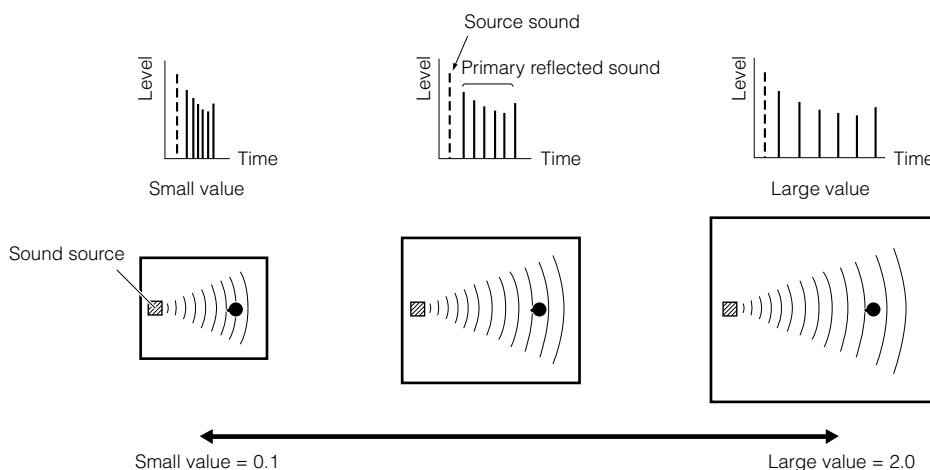

■ LIVENESS

Function This parameter adjusts the reflectivity of the virtual walls in the hall by changing the rate at which the early reflections decay.

Control range 0 – 10

Description The early reflections of a sound source decay much faster in a room with acoustically absorbent wall surfaces than in one which has highly reflective surfaces. A room with acoustically absorbent surfaces is referred to as “dead,” while a room with highly reflective surfaces is referred to as “live”. The LIVENESS parameter lets you adjust the early reflection decay rate, and thus the “liveness” of the room.

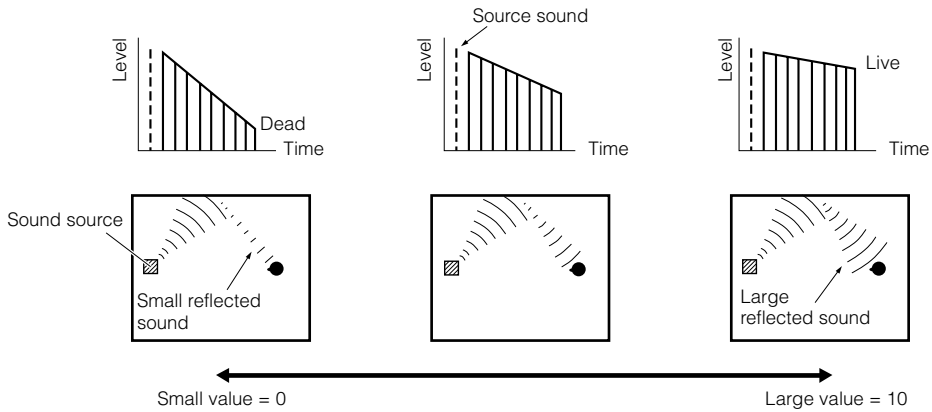

■ P. INIT. DLY (Presence Initial Delay)

Function This parameter adjusts the delay between the direct sound and the first reflection in the presence sound field.

Control range 1 – 99 ms

Description The larger the value, the later the first reflection begins.

■ S. INIT. DLY (Surround Initial Delay)

Function This parameter adjusts the delay between the direct sound and the first reflection on the surround side of the sound field. You can only adjust this parameter when at least two front channels and two rear channels are used.

Control range 1 – 49 ms

Description The larger the value, the later the first reflection begins. You can only adjust this parameter for the Dolby Digital and DTS signals.

DIGITAL SOUND FIELD PARAMETER DESCRIPTIONS

■ S. DELAY (Surround Delay)

- Function** This parameter adjusts the delay between the direct sound and the first reflection in the surround sound field.
- Control range** 0 – 49 ms (The range depends on the signal format.)
- Description** When Dolby Digital signals are decoded: the larger the parameter, the later the surround sound source begins.
When a non-Dolby Digital program is decoded: the larger the parameter, the later the surround sound field begins.
No surround sound source is produced.

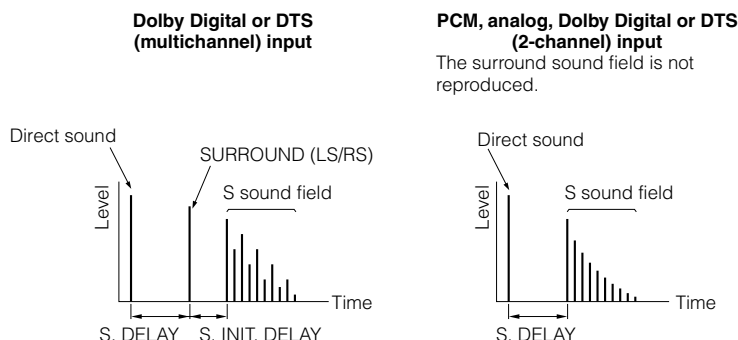

■ S. ROOM SIZE (Surround Room Size)

- Function** This parameter adjusts the apparent size of the surround sound field.
- Control range** 0.1 – 2.0
- Description** The larger the value, the larger the surround sound field becomes.

■ S. LIVENESS (Surround Liveness)

- Function** This parameter adjusts the apparent reflectivity of the virtual walls in the surround sound field.
- Control range** 0 – 10
- Description** The larger the value, the more reflective the surround sound field walls become.

■ RC INI. DLY (Rear Center Initial Delay)

- Function** This parameter adjusts the delay between the direct sound and the first reflection in the rear center sound field.
- Control range** 1 – 49 ms
- Description** The larger the value, the later the first reflection begins.

■ RC ROOM SIZE (Rear Center Room Size)

- Function** This parameter adjusts the apparent size of the rear center sound field.
- Control range** 0.1 – 2.0
- Description** The larger the value, the more reflective the presence sound field walls become.

■ RC LIVENESS (Rear Center Liveness)

- Function** This parameter adjusts the apparent reflectivity of the virtual wall in the rear center sound field.
- Control range** 0 – 10
- Description** The larger the value, the more reflective the surround sound field walls become.

REV. TIME (Reverberation Time)

Function This parameter adjusts the amount of time it takes for the dense, subsequent reverberation sound to decay by 60 dB (at 1 kHz). This changes the apparent size of the acoustic environment over an extremely wide range.

Control range 1.0 – 5.0 s

Description Set a longer reverberation time for “dead” sources and listening room environments and a shorter time for “live” sources and listening room environments.

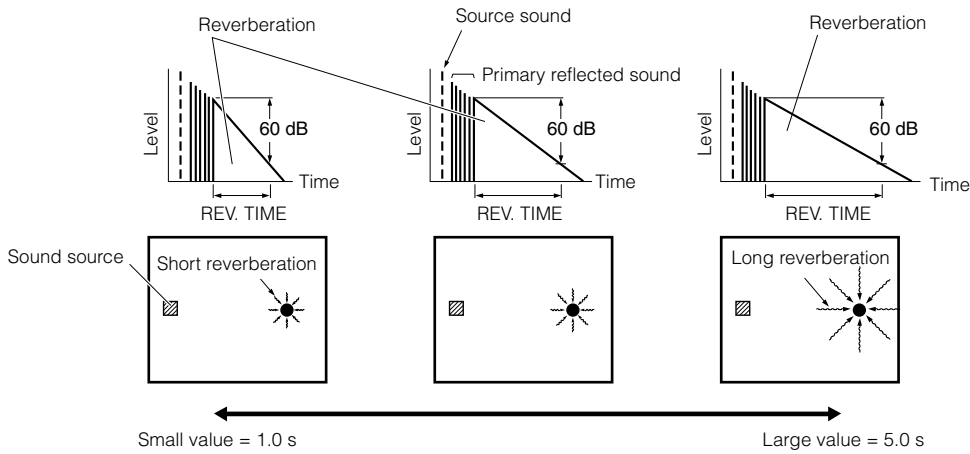

REV. DELAY (Reverberation Delay)

Function This parameter adjusts the time difference between the beginning of the direct sound and the beginning of the reverberation sound.

Control range 0 – 250 ms

Description The larger the value, the later the reverberation sound begins. A later reverberation sound makes you feel like you are in a larger acoustic environment.

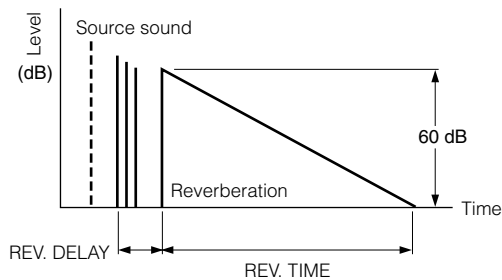

REV. LEVEL (Reverberation Level)

Function This parameter adjusts the volume of the reverberation sound.

Control range 0 – 100%

Description The larger the value, the stronger the reverberation becomes.

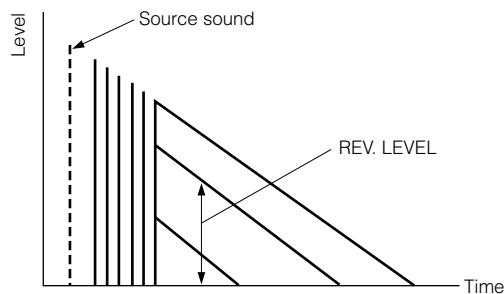

DIGITAL SOUND FIELD PARAMETER DESCRIPTIONS

For 8ch Stereo

- **CT LEVEL (Center Level)**
- **RL LEVEL (Rear Left Level)**
- **RC LEVEL (Rear Center Level)**
- **RR LEVEL (Rear Right Level)**
- **FL LEVEL (Front Left Level)**
- **FR LEVEL (Front Right Level)**

Function These parameters adjust the volume level for each channel in 8-channel stereo mode.

Control range 0 – 100 %

For PRO LOGIC II Music

■ **PANORAMA**

Function This parameter extends the front stereo image to include the surround speakers for wraparound effect.

Control range OFF/ON

■ **DIMENSION**

Function This parameter gradually adjusts the soundfield either towards the front or towards the rear.

Control range -3 – STD – +3

■ **CENTER WIDTH**

Function This parameter adjusts the center image from all three front speakers to varying degrees.

Control range 0 – 7

For DTS Neo: 6 Music

■ **C. IMAGE (Center Image)**

Function This parameter adjusts the center image from all three front speakers to varying degrees.

Control range 0 – 0.5

Appendix

TROUBLESHOOTING	102
CINEMA EQ FREQUENCY CHARACTERISTICS	105
REFERENCE CHART FOR THE INPUT AND OUTPUT JACKS	106
SPECIFICATIONS	107

TROUBLESHOOTING

Refer to the chart below when this unit does not function properly. If the problem you are experiencing is not listed below or if the instruction below does not help, set this unit in the standby mode, disconnect the power cord, and contact the nearest authorized YAMAHA dealer or service center.

■ General

Problem	Cause	Remedy
This unit fails to turn on when STANDBY/ON (or SYSTEM POWER) is pressed, or enters in the standby mode soon after the power has been turned on.	The power cord is not connected or the plug is not completely inserted.	Firmly connect the power cord.
	IMPEDANCE SELECTOR on the rear panel is not fully set to the upper or lower position.	Set the switch fully to the upper or lower position when this unit is in the standby mode.
	The protection circuitry has been activated.	Make sure all speaker wire connections on this unit and on all speakers are secure and that the wire for each connection does not touch anything other than its respective connection.
	This unit has been exposed to a strong external electric shock (such as lightning and strong static electricity).	Set this unit in the standby mode, disconnect the power cord, plug it back in after 30 seconds, and start operating.
On-screen display does not appear.	The setting for the on-screen display is set to "DISPLAY OFF".	Select the full display or short display mode (see page 33).
	The BLUE BACK setting under "15 DISPLAY SET" on the SET MENU is set to "OFF", and no video signal is input to this unit.	Set BLUE BACK to "AUTO" to always show the OSD (see page 62).
No sound and/or no picture.	Incorrect input or output cable connections.	Connect the cables properly. If the problem persists, the cables may be defective.
	An appropriate input source has not been selected.	Select an appropriate input source with INPUT SELECTOR or 6CH INPUT (or the input selector buttons) (see page 42).
	The speaker connections are not secure.	Secure the connections.
	The main speakers to be used have not been selected properly.	Select the main speakers with SPEAKERS A and/or B (see page 42).
	The volume is turned down.	Turn up the volume.
	The sound is muted.	Press MUTE or any operation buttons of this unit to cancel a mute and adjust the volume.
	The signals that this unit cannot reproduce such as a CD-ROM are being input.	Play a source whose signals this unit can reproduce.
	The output and input for the picture are connected to different types of video jacks.	Make connections using the same type of jack (between S VIDEO , VIDEO (composite), or COMPONENT VIDEO jacks) for both the input and output.
The sound suddenly goes off.	The protection circuit has been activated because of a short circuit, etc.	Check IMPEDANCE SELECTOR is set to the appropriate position and then turn this unit back on. Check the speaker wires are not touching each other and then turn this unit back on.
	The sleep timer has functioned.	Turn on the power, and play the source again.
	The sound is muted.	Press MUTE or any operation buttons of this unit to cancel a mute and adjust the volume.
Only the speaker on one side can be heard.	Incorrect cable connections.	Connect the cables properly. If the problem persists, the cables may be defective.
	BALANCE is turned to the left or right end.	Adjust it to the appropriate position.

Problem	Cause	Remedy
No sound from the effect speakers.	The input source is being played with normal stereo reproduction. ("STEREO" is shown in the front panel display.)	Press STEREO/EFFECT to turn on the sound effect (see page 47).
	Digital signals that are over 96 kHz sampling frequency are input into this unit.	
No sound from the center speaker.	"1A CENTER SP" on the SET MENU is set to "NONE".	Select the appropriate mode for your center speaker (see page 35).
	One of the Hi-Fi DSP programs (1 to 6 except for Game and 8ch Stereo) has been selected.	Select another DSP program.
No sound from the rear speakers.	"1C REAR L/R SP" on the SET MENU is set to "NONE".	Select the appropriate speaker mode for the rear L/R speakers (see page 36).
	A monaural source is being played with the program 12.	Select another DSP program.
No sound from the rear center speaker.	"1C REAR L/R SP" on the SET MENU is set to "NONE".	If the speaker mode for the rear L/R speakers is set to "NONE", the speaker mode for the rear center speaker is automatically set to "NONE". Select the appropriate speaker mode for the rear L/R speaker mode (see page 36).
	"1D REAR CT SP" on the SET MENU is set to "NONE".	Select "LRG" or "SML" (see page 36).
No sound from the subwoofer.	"1E LFE/BASS OUT" on the SET MENU is set to "MAIN" when a Dolby Digital or DTS signal is being played.	Select "SW" or "BOTH" (see page 37).
	"1E LFE/BASS OUT" on the SET MENU is set to "SW" or "MAIN" when a 2-channel source is being played.	Select "BOTH" (see page 37).
	The source does not contain low bass signals (90 Hz and below).	
Poor bass reproduction.	"1E LFE/BASS OUT" on the SET MENU is set to "SW" or "BOTH" and your system does not include a subwoofer.	Select "MAIN" (see page 37).
	The output mode for each speaker (main, center, rear, or rear center) on the SET MENU does not match your speaker configuration.	Select the appropriate output mode for each speaker based on the size of the speakers in your configuration.
A "humming" sound can be heard.	Incorrect cable connections.	Firmly connect the audio plugs. If the problem persists, the cables may be defective.
	No connection from the turntable to the GND terminal.	Connect the grounding cord of your turntable to the GND terminal of this unit (see page 20).
The volume level is low while playing a record.	The record is being played on a turntable with an MC cartridge.	The turntable should be connected to this unit through an MC-head amplifier.
The volume level cannot be increased, or the sound is distorted.	The component connected to the OUT (REC) jacks of this unit is turned off.	Turn on the power to the component.
A source cannot be recorded.	A source component is connected to the analog input jacks of this unit for digital recording.	Connect a source component to the digital input jacks.
	Digital connections are not made between this unit and other components for playback or recording.	Make digital connections.
	A source component is connected to the digital input jacks of this unit for analog recording.	Connect a source component to the analog input jacks.
	Analog connections are not made between this unit and other components for playback or recording.	Make analog connections.
	Some recording components cannot record the Dolby Digital or DTS sources.	

TROUBLESHOOTING

Problem	Cause	Remedy
The sound field parameters and some other settings on this unit cannot be changed.	“16 MEMORY GUARD” on the SET MENU is set to “ON”.	Select “OFF” (see page 62).
This unit does not operate properly.	The internal microcomputer has been frozen by an external electric shock (such as lightning or excessive static electricity) or by a power supply with low voltage.	Disconnect the AC power cord from the outlet and then plug it in again after about 30 seconds.
“CHECK SP WIRES” appears on the front panel display.	Speaker cables are short circuited.	Make sure all speaker cables are connected correctly.
The sound is degraded when listening with headphones connected to a tape deck or CD player that is connected to this unit.	This unit is in the standby mode.	Turn on the power of this unit.
There is noise interference from digital or high-frequency equipment, or this unit.	This unit is too close to the digital or high-frequency equipment.	Move this unit further away from such equipment.
This unit suddenly turns into the standby mode.	The internal temperature becomes too high and the overheat protection circuitry has been activated.	Wait until this unit cools down and then turn it back on.

■ Remote control

Problem	Cause	Remedy
The remote control does not work nor function properly.	Wrong distance or angle.	The remote control will function within a maximum range of 6 m (20 feet) and no more than 30 degrees off-axis from the front panel (see page 10).
	Direct sunlight or lighting (from an inverter type of fluorescent lamp, etc.) is striking the remote control sensor of this unit.	Reposition this unit.
	The batteries are weak.	Replace all batteries with new ones and press RESET .
	The manufacturer code has not been correctly set.	Set the manufacturer code correctly (see page 66).
		Try to set the other codes of the same manufacturer (see page 66).
Even if the manufacturer code is correctly set, there are some models that do not respond to the remote control.	Program the necessary functions independently into the programmable buttons on this unit’s remote control using the Learn feature.	
The remote control does not “learn” new functions.	The batteries of this remote control and/or the other remote control are too weak.	Replace the batteries.
	The distance between the two remote controls is too much or too little.	Place the remote controls at the proper distance (see page 68).
	The signal coding or modulation of the other remote control is not compatible with this remote control.	Learning is not possible.
	Memory capacity is full.	Further learning is not possible without deleting unnecessary functions (see page 79).

CINEMA EQ FREQUENCY CHARACTERISTICS

■ L, C, R preset value

HIGH: FRQ 12.7 kHz/GAIN -3 dB

PEQ: FRQ 12.7 kHz/GAIN -4 dB

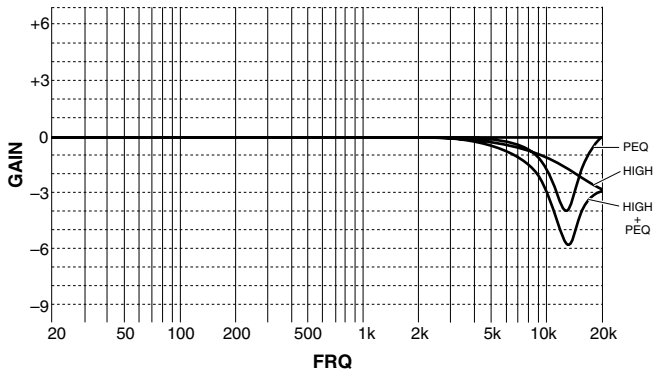

■ FRONT and REAR preset value

HIGH: FRQ 12.7 kHz/GAIN 0 dB

PEQ: FRQ 8.0 kHz/GAIN -3 dB

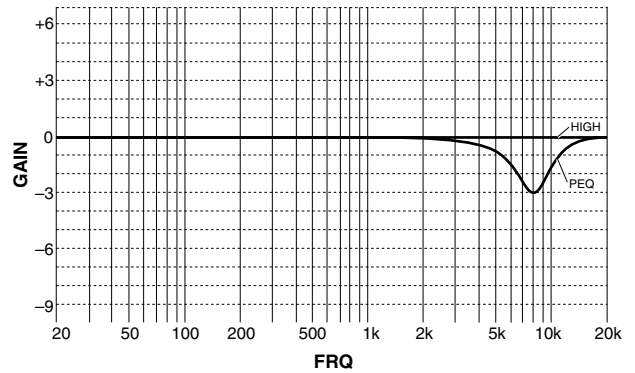

■ HIGH frequency

FRQ 1.0 kHz/GAIN +6 - -9 dB

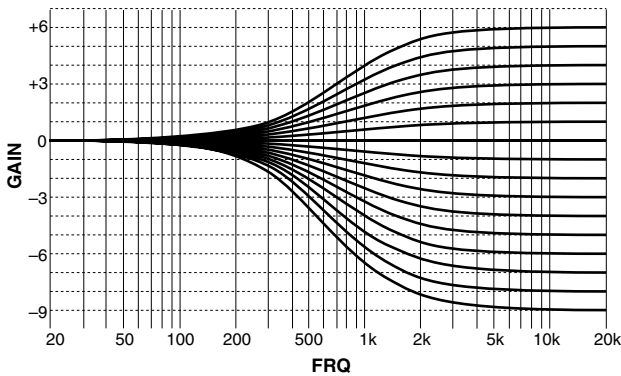

FRQ 1.0 - 12.7 kHz/GAIN +6/-9 dB

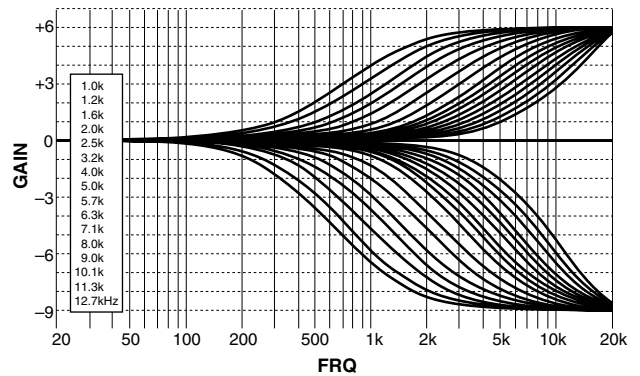

■ PEQ frequency

FRQ 1.0 kHz/GAIN +6 - -9 dB/Q 1.85 (fixed)

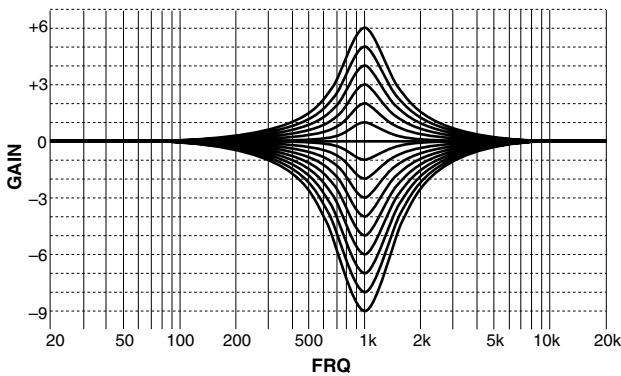

FRQ 1.0 - 12.7 kHz/GAIN +6/-9 dB/Q 1.85 (fixed)

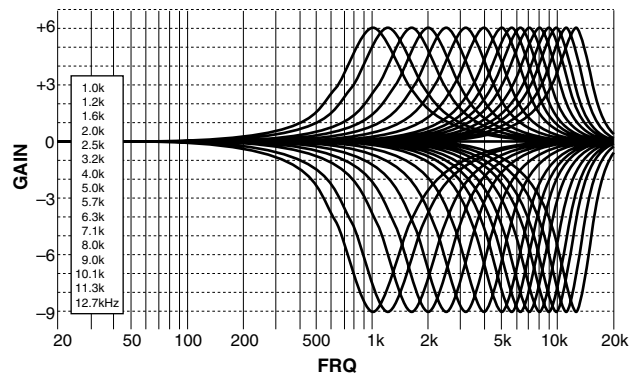

REFERENCE CHART FOR THE INPUT AND OUTPUT JACKS

	AUDIO						VIDEO					
	ANALOG		DIGITAL *1				COMPOSITE		S VIDEO		COMPONENT	
	IN	OUT	COAXIAL		OPTICAL							
			IN	OUT	IN	OUT	IN	OUT	IN	OUT		
PHONO	✓											
CD	✓		✓		✓							
TUNER	✓											
CD-R	✓	✓			✓	✓						
MD/TAPE	✓	✓				✓						
DVD	✓		✓		✓		✓		✓		✓*1	
D-TV/LD	✓		✓*2		✓		✓		✓		✓*1	
CABLE	✓		✓				✓		✓			
SAT	✓				✓		✓		✓		✓*1	
VCR 1	✓	✓					✓	✓	✓	✓		
VCR 2	✓	✓					✓	✓	✓	✓		
VCR 3/DVR	✓	✓			✓		✓	✓	✓	✓		
VIDEO AUX	✓				✓		✓		✓			
6CH INPUT												
MAIN	✓											
SURROUND	✓											
CENTER	✓											
SUBWOOFER	✓											
PREOUT/MAIN IN												
MAIN	✓	✓										
REAR (SURROUND)		✓										
CENTER	✓	✓										
REAR CTR		✓										
SUBWOOFER		✓										
FRONT	✓	✓										
MONITOR OUT								✓		✓		✓
ZONE 2 OUT		✓						✓				
PHONES		✓										
SPEAKERS	MAIN A/B, REAR (SURROUND), CENTER, REAR CENTER, FRONT											

*1 You can designate the input for these jacks according to your component by using "8 I/O ASSIGNMENT" on the SET MENU (see page 58 for details).

*2 You can switch the setting of this jack between **LD DD RF (AC-3)** and **COAXIAL LD** by using "8 I/O ASSIGNMENT" on the SET MENU (see page 58 for details).

SPECIFICATIONS

■ Audio Section

Minimum RMS Output Power per Channel		
MAIN L/R, CENTER, REAR L/R/C (20 Hz to 20 kHz, 0.015% THD, 8 Ω)	130 W	
FRONT L/R (1 kHz, 0.05% THD, 8 Ω)	45 W	
Maximum Power [for General and China models]		
MAIN L/R, CENTER, REAR L/R/C (1 kHz, 10% THD, 8 Ω)	200 W	
FRONT L/R (1 kHz, 10% THD, 8 Ω)	65 W	
Dynamic Power (IHF) [for General and China models]		
MAIN L/R (8/6/4/2 Ω)	160/200/260/360 W	
Dynamic Headroom [for General and China models]		
MAIN L/R (8 Ω)	1.3 dB	
DIN Standard Output Power per Channel [for Europe and U.K. models]		
MAIN L/R (1 kHz, 0.7% THD, 4 Ω)	210 W	
IEC Power [for Europe and U.K. models]		
MAIN L/R (1 kHz, 0.015% THD, 8 Ω)	140 W	
Power Band Width		
MAIN L/R (55 W, 0.04% THD, 8 Ω)	10 Hz to 50 kHz	
Damping Factor		
MAIN L/R (20 Hz to 20 kHz, 8 Ω)	200 or more	
Input Sensitivity/Impedance (100 W/8 Ω)		
CD, etc.	150 mV/47 kΩ	
PHONO MM	2.5 mV/47 kΩ	
MAIN IN	1 V/47 kΩ	
Output Level/Impedance		
REC OUT	150 mV/600 Ω	
MAIN OUT	1 V/1.2 kΩ	
SUBWOOFER		
[SPLIT L/R]	2 V/1.2 kΩ	
[MONO]	4 V/1.2 kΩ	
PHONES Output	150 mV/100 Ω	
Frequency Response (10 Hz to 100 kHz)		
CD, etc. to MAIN L/R SP. OUT	-3 dB	
Total Harmonic Distortion (20 Hz to 20 kHz)		
CD, etc. to MAIN OUT (1 V)	0.005% or less	
MAIN IN to SP OUT (65 W/8 Ω)	0.005% or less	
Signal to Noise Ratio (IHF-A network) (Input shorted, EFFECT off, 250 mV)		100 dB or more
Residual Noise (IHF-A network)		
MAIN L/R SP. OUT	150 μV or less	
Channel Separation (Vol -30 dB, 5.1 kΩ terminated)		
1 kHz/10 kHz	70 dB/60 dB or more	
Tone Control (MAIN L/R)		
Bass Boost/Cut	±10 dB (50 Hz)	
Treble Boost/Cut	±10 dB (20 kHz)	
Bass Extension	+6 dB (60 Hz)	

■ Video Section

Video Signal Type	
[Europe and U.K. models]	PAL
[General and China models]	NTSC/PAL
Composite Video Signal Level	1 Vp-p/75 Ω
S-Video Signal Level	
Y	1 Vp-p/75 Ω
C	0.286 Vp-p/75 Ω
Component Video Signal Level	
Y	1 Vp-p/75 Ω
PB/CB, Pr/CR	0.7 Vp-p/75 Ω
Maximum Input Level	1.5 Vp-p
Signal to Noise Ratio	50 dB or more
Frequency Response (MONITOR OUT)	
VIDEO, S VIDEO	5 Hz to 10 MHz, -3 dB
COMPONENT VIDEO	DC to 100 MHz, -3 dB

■ General

Power Supply	
[Europe and U.K. models]	AC 230 V, 50 Hz
[General and China models]	AC 110/120/220/240 V, 50/60 Hz
Power Consumption	650 W
Standby Mode [Europe and U.K. models]	1.2 W
Standby Mode [General and China models]	1.5 W
AC Outlets (Total 100 W maximum)	
[U.K. model]	1 (Switched)
[Other models]	3 (Switched)
Dimensions (W x H x D)	435 x 211 x 473 mm (17-1/8" x 8-1/4" x 18-5/8")
Weight	28 kg (61 lbs 11 oz)
Accessories	Remote control Batteries (3) (LR6) Power cord (except for U.K. model)

* Specifications are subject to change without notice.



YAMAHA ELECTRONICS CORPORATION, USA 6660 ORANGETHORPE AVE., BUENA PARK, CALIF. 90620, U.S.A.
YAMAHA CANADA MUSIC LTD. 135 MILNER AVE., SCARBOROUGH, ONTARIO M1S 3R1, CANADA
YAMAHA ELECTRONIK EUROPA G.m.b.H. SIEMENSSTR. 22-34, 25462 RELINGEN BEI HAMBURG, F.R. OF GERMANY
YAMAHA ELECTRONIQUE FRANCE S.A. RUE AMBROISE CROIZAT BP70 CROISSY-BEAUBOURG 77312 MARNE-LA-VALLÉE CEDEX02, FRANCE
YAMAHA ELECTRONICS (UK) LTD. YAMAHA HOUSE, 200 RICKMANSWORTH ROAD WATFORD, HERTS WD1 7JS, ENGLAND
YAMAHA SCANDINAVIA A.B. J A WETTERGRENS GATA 1, BOX 30053, 400 43 VÄSTRA FRÖLUNDA, SWEDEN
YAMAHA MUSIC AUSTRALIA PTY, LTD. 17-33 MARKET ST., SOUTH MELBOURNE, 3205 VIC., AUSTRALIA

YAMAHA CORPORATION
Printed in Japan **UP** VIDEO V844660