

# YAMAHA KX-650

*Natural Sound Stereo Cassette Deck*

CENTER

OWNER'S MANUAL



**IMPORTANT**

Please record the serial number of your unit in the space below.

Model: **KX-650**

Serial No:

The serial number is located on the rear of the unit.  
Retain this Owner's Manual in a safe place for future reference.

Thank you for purchasing the YAMAHA KX-650 stereo cassette deck.

## SAFETY INSTRUCTIONS

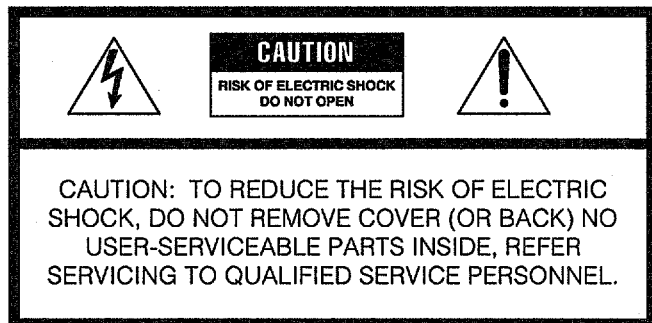

### • Explanation of Graphical Symbols



The lightning flash with arrowhead symbol, within an equilateral triangle, is intended to alert you to the presence of uninsulated "dangerous voltage" within the product's enclosure that may be of sufficient magnitude to constitute a risk of electric shock to persons.



The exclamation point within an equilateral triangle is intended to alert you to the presence of important operating and maintenance (servicing) instructions in the literature accompanying the appliance.

### WARNING

To reduce the risk of fire or electric shock, do not expose this appliance to rain or moisture.

- 1 Read Instructions — All the safety and operating instructions should be read before the appliance is operated.
- 2 Retain Instructions — The safety and operating instructions should be retained for future reference.
- 3 Heed Warnings — All warnings on the appliance and in the operating instructions should be adhered to.
- 4 Follow Instructions — All operating and other instructions should be followed.
- 5 Water and Moisture — The appliance should not be used near water — for example, near a bathtub, washbowl, kitchen sink, laundry tub, in a wet basement, or near swimming pool, etc.
- 6 Carts and Stands — The appliance should be used only with a cart or stand that is recommended by the manufacturer.
- 6A An appliance and cart combination should be moved with care. Quick stops, excessive force, and uneven surfaces may cause the appliance and cart combination to overturn.



7 Wall or Ceiling Mounting — The appliance should be mounted to a wall or ceiling only as recommended by the manufacturer.

8 Ventilation — The appliance should be situated so that its location or position does not interfere with its proper ventilation. For example, the appliance should not be situated on a bed, sofa, rug or similar surfaced that may block the ventilation openings; or placed in a built-in installation, such as a bookcase or cabinet that may impede the flow of air through the ventilation openings.

9 Heat — The appliance should be situated away from heat sources such as radiators, stoves, or other appliances that produce heat.

10 Power Sources — The appliance should be connected to a power supply only of the type described in the operating instructions or as marked on the appliance.

11 Power-Cord Protection — Power-supply cords should be routed so that they are not likely to be walked on or pinched by items placed upon or against them, paying receptacles, and the point where they exit from the appliance.

12 Cleaning — The appliance should be cleaned only as recommended by the manufacturer.

13 Non use Periods — The power cord of the appliance should be unplugged from the outlet when left unused for a long period of time.

14 Object and Liquid Entry — Care should be taken so that objects do not fall into and liquids not spilled into the inside of the appliance.

15 Damage Requiring Service — The appliance should be serviced by qualified service personnel when:

- A. The power-supply cord or the plug has been damaged; or
- B. Objects have fallen, or liquid has been spilled into the appliance; or
- C. The appliance has been exposed to rain; or
- D. The appliance does not appear to operate normally or exhibits a marked change in performance; or
- E. The appliance has been dropped, or the cabinet damaged.

16 Servicing — The user should not attempt to service the appliance beyond those means described in the operating instructions. All other servicing should be referred to qualified service personnel.

### FCC INFORMATION (U.S.A.)

1. IMPORTANT NOTICE: DO NOT MODIFY THIS UNIT!  
This product, when installed as indicated in the instructions contained in this manual, meets FCC requirements. Modifications not expressly approved by Yamaha may void your authority, granted by the FCC, to use the product.
2. IMPORTANT: When connecting this product to accessories and/or another product use only high quality shielded cables. Cable/s supplied with this product MUST be used. Follow all installation instructions. Failure to follow instructions could void your FCC authorization to use this product in the USA.

---

**CAUTION: READ THIS BEFORE  
OPERATING YOUR UNIT.**

---

3. NOTE: This product has been tested and found to comply with the requirements listed in FCC Regulations, Part 15 for Class "A" digital devices. Compliance with these requirements provides a reasonable level of assurance that your use of this product, in a commercial environment, will not result in harmful interference with other electronic devices. However, operation of this product in a residential area is likely to cause interference in some form. In this case you, the user, bear the responsibility of correcting this condition.

This product generates/uses radio frequencies and, if not installed and used according to the instructions found in the users manual, may cause interference harmful to the operation of other electronic devices. Compliance with FCC regulations does not guarantee that interference will not occur in all installations. If this product is found to be the source of interference, which can be determined by turning the product "OFF" and "ON", please try to eliminate the problem using one of the following measures:

Relocate either the product generating the interference or the device that is being affected by the interference.

Utilize power outlets that are on different branch (circuit breaker or fuse) circuits or install AC line filter/s.

In the case of radio or TV interference, relocate/reorient the antenna. If the antenna lead-in is 300 ohm ribbon lead, change the lead-in to coaxial type cable.

If these corrective measures do not produce satisfactory results, please contact your local retailer that is authorized to distribute this type of product. If you cannot locate the appropriate retailer, please contact Yamaha Electronics Corp., U.S.A. 6722 Orangethorpe Ave, Buena Park, CA90620

The above statements apply ONLY to those products distributed by Yamaha Corporation of America or its subsidiaries.

**WARNING: CHEMICAL  
CONTENT NOTICE!**

The solder used in the manufacture of this product contains LEAD. In addition, the electrical/electronic and/or plastic (where applicable) components may also contain traces of chemicals found by the California Health and Welfare Agency (and possibly other entities) to cause cancer and/or birth defects or other reproductive harm.

**DO NOT REMOVE ANY ENCLOSURE COMPONENTS!** There are no user serviceable parts inside. All service should be performed by a service representative authorized by Yamaha to perform such service.

**IMPORTANT MESSAGE:** Yamaha strives to produce products that are both user safe and environmentally "friendly". We sincerely believe that our products meet these goals. However, in keeping with both the spirit and the letter of various statutes we have included the messages shown above and others in various locations in this manual.

1. This unit is a sophisticated stereo cassette deck. To ensure proper operation for the best possible performance, please read this manual carefully.
2. Choose the installation location of your unit carefully. Avoid placing it in direct sunlight or close to source of heat. Also avoid locations subject to vibration and excessive dust, heat, cold or moisture. Keep it away from sources of hum such as transformers or motors.
3. Do not open the cabinet as this may result in damage to the deck or electrical shock. If a foreign object should get into the deck, contact your local dealer.
4. When removing the power plug from the wall outlet, always pull directly on the plug; never pull the cord itself.
5. Do not apply excessive force when operating switches and knobs.
6. When moving the deck, be sure to first pull out the power plug and remove all cords connecting the deck to other equipment.
7. Do not attempt to clean this unit with chemical solvents as this may damage the finish. Use a clean, dry cloth.
8. Never allow metallic items (e.g. screwdrivers, tools, etc.) to come near the record/playback head assembly. Doing so may not only scratch or damage the head's mirror-smooth finish, it may also change the magnetic characteristics of the heads, causing a deterioration in reproduction quality.
9. Although the record/playback head used in this unit is a high quality head with outstanding reproduction characteristics, it can become dirty through the use of old tapes or from dust accumulation over time. This can have a serious effect on reproduction quality. Clean the heads regularly with one of the commonly available head cleaners or with cleaning solutions as explained later in this manual.
10. Be sure to read the "Troubleshooting" section of this manual for advice on common operating errors before concluding that your unit is faulty.
11. Keep this manual in a safe place for future reference.
12. Voltage Selector (general model only)  
The voltage selector on the rear panel of this unit must be set for your local mains voltage BEFORE plugging in the AC mains supply.

## TABLE OF CONTENTS

Features .....	3	• Rec mute operation - Inserting a blank space during recording .....	9
Connections .....	3	• Rec Return operation - To return to the point at which the recording previously started .....	9
Playback .....	4	• 0-stop operation - To return to the "0:00" point .....	9
• Selection search - To playback a desired selection by searching for the beginning of the selection .....	5	Cassette tapes .....	10
• Intro scan - To play back the beginning of each selection automatically .....	6	Maintenance .....	11
• Memory stop operation - To return to the desired position .....	6	Remote control transmitter .....	11
Recording .....	7	Troubleshooting .....	12
		Specifications .....	13

## FEATURES

- 3-Head Configuration
- Dolby HX Pro Dynamic Bias Servo
- Dolby B/C Noise Reduction
- Fine Adjustment of Recording Bias with Bias Adjust Control
- Play Trim Control for Improved Playback Compatibility with Other Decks
- Selection Search and Bi-Directional Intro Scan
- Recording Mute function
- REC Return/0-stop Operation

## CONNECTIONS

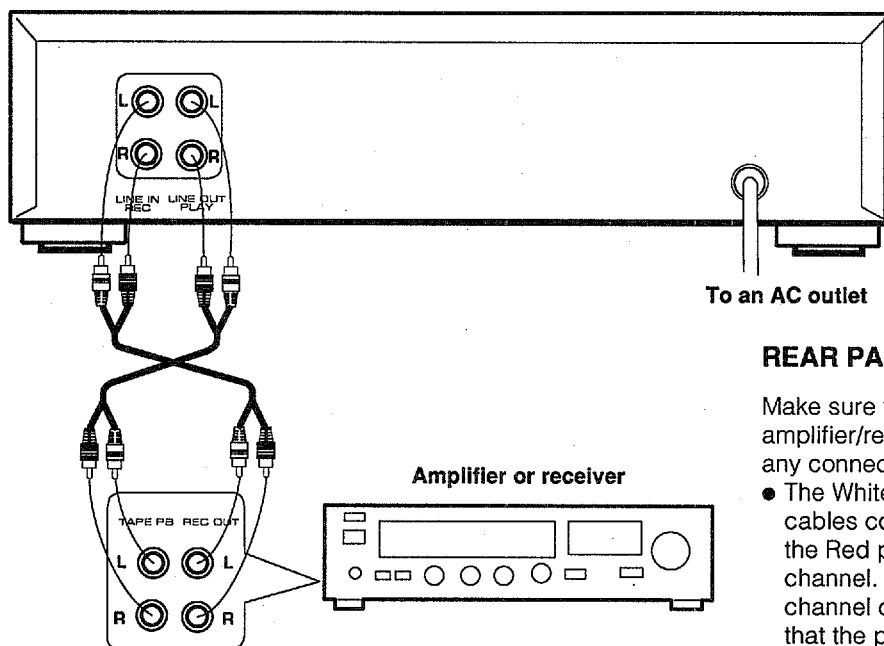

### REAR PANEL CONNECTIONS

Make sure that power to both the deck and your amplifier/receiver are turned off before making any connection.

- The White plug on the paired connecting cables corresponds to the Left channel and the Red plug corresponds to the Right channel. Make sure that the left and right channel connections are properly made, and that the plugs are inserted firmly.
- The LINE OUT/PLAY jacks on the deck should be connected to the Tape PB (Playback/ Input) jacks on your amplifier/receiver, and the LINE IN/REC jacks on the deck should be connected to the Rec Out (Rec/Output) jacks on your amplifier/receiver.
- Connect the power cord to an AC wall outlet or to an AC outlet on the rear panel of your amplifier/receiver (if provided).

# PLAYBACK

## Preparation for playback

- Turn on the POWER switch.
- Set your amplifier or receiver to cassette deck function mode.

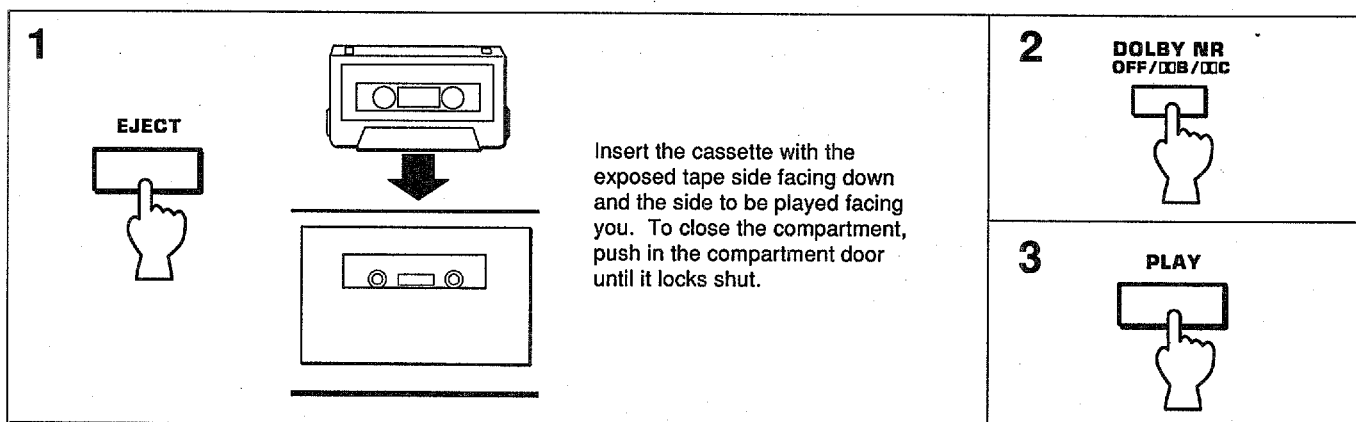
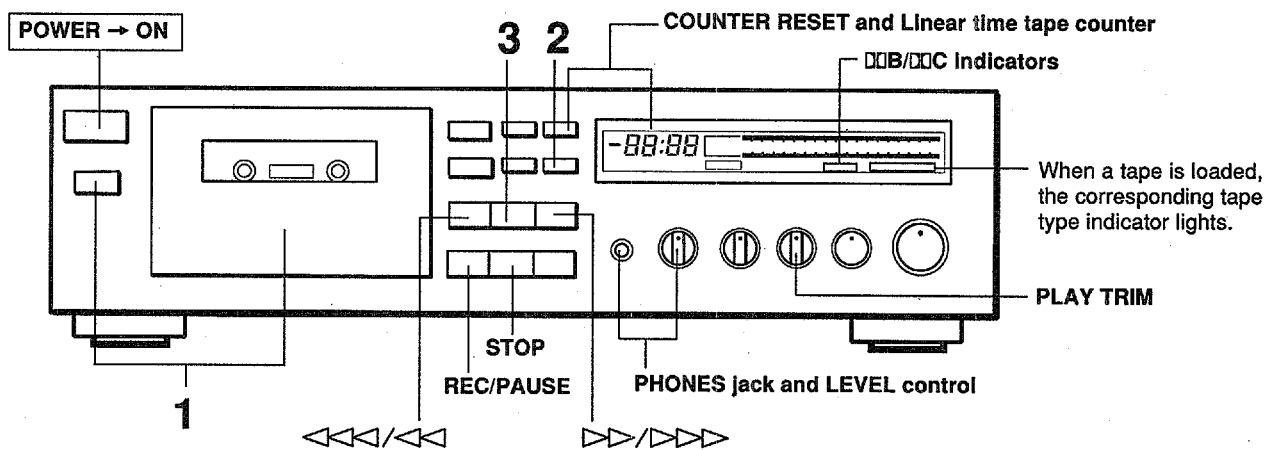

### To stop playback:

Press the STOP button.

### To fast forward the tape:

Press the  $\triangleright\triangleright\triangleright\triangleright$  button and keep pressing for more than 2 seconds to advance at high speed.

### To fast rewind the tape:

Press the  $\triangleleft\triangleleft\triangleleft\triangleleft$  button and keep pressing for more than 2 seconds to rewind at high speed.

### To adjust the volume level:

Use the volume control of the amplifier or receiver.

### To use headphones for private listening:

Insert the headphones plug into the PHONES jack and adjust the volume with LEVEL control.

### Linear time tape counter

Use the linear time tape counter as aid in locating a point on a tape. To set the counter reading to "0:00", press the COUNTER RESET button.

This counter is not an actual clock, so the indicated number will not exactly equal the actual elapsed time.

### DOLBY NR button setting (in step 2)

Be sure to set the DOLBY NR button according to the system used for recording.

Each time this button is pressed, Dolby NR switches to  $\square\square B$ , to  $\square\square C$ , to OFF and back around to  $\square\square B$ .

**OFF:** For a tape recorded with DOLBY NR OFF.

**$\square\square B$ :** For a tape recorded with DOLBY B NR. The  $\square\square B$  indicator lights.

**$\square\square C$ :** For a tape recorded with DOLBY C NR. The  $\square\square C$  indicator lights.

\* Dolby noise reduction manufactured under license from Dolby Laboratories Licensing Corporation. "DOLBY" and the double-D symbol  $\square\square$  are trademarks of Dolby Laboratories Licensing Corporation.

### NOTE:

During playback, if the monitor mode is switched to the source monitor mode, no sound is heard. (The SOURCE indicator lights.)

Press the MONITOR button so that the TAPE indicator lights.

# PLAYBACK

## PLAY TRIM control adjustment

When distortion or the absence of high frequencies is noticeable when playing a tape recorded on another cassette deck, compensate the high frequency response with the PLAY TRIM control.

When distortion is noticeable, attenuate the high frequencies.

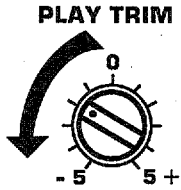

When high frequencies are absent, boost the high frequencies.

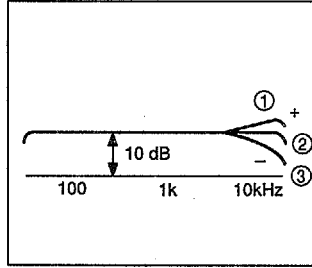
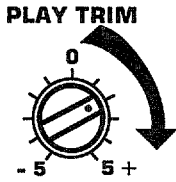

- ① High frequency sound is distorted.
- ② Flat
- ③ High-frequency sound is absent.

## Selection search - To play back a desired selection by searching for the beginning of the selection

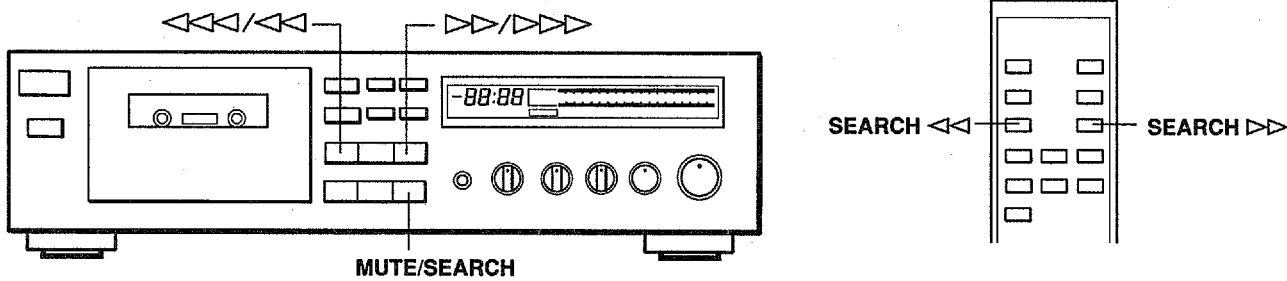

### To search for the next selection

Front panel

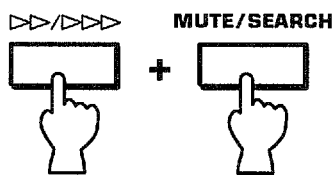

The  $\gg/\gg$  button and the MUTE/SEARCH button should be pressed simultaneously.

or

Remote control transmitter



### To search for the beginning of the current selection

Front panel

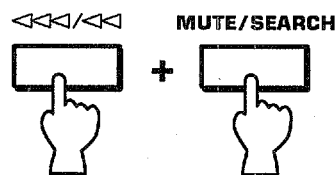

The  $\ll/\ll$  button and the MUTE/SEARCH button should be pressed simultaneously.

or

Remote control transmitter



### To search for the selection located before the current selection

When the beginning of the current selection is played:

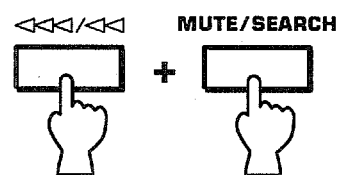

or



**Intro scan - To play back the beginning of each selection automatically**

The intro scan function can be controlled via the remote control transmitter only.

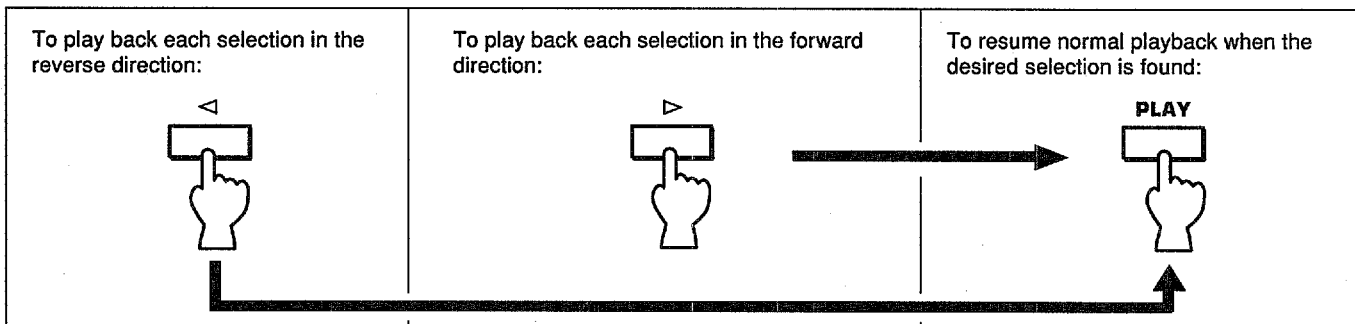
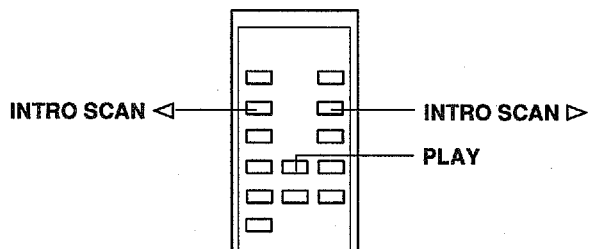

**Notes on Selection search and Intro scan**

- The blank section between selections must be at least 4 seconds.
- With tapes recorded with low level or having excessive noise, these operations may not be carried out.

**Memory stop operation - To return to the desired position**

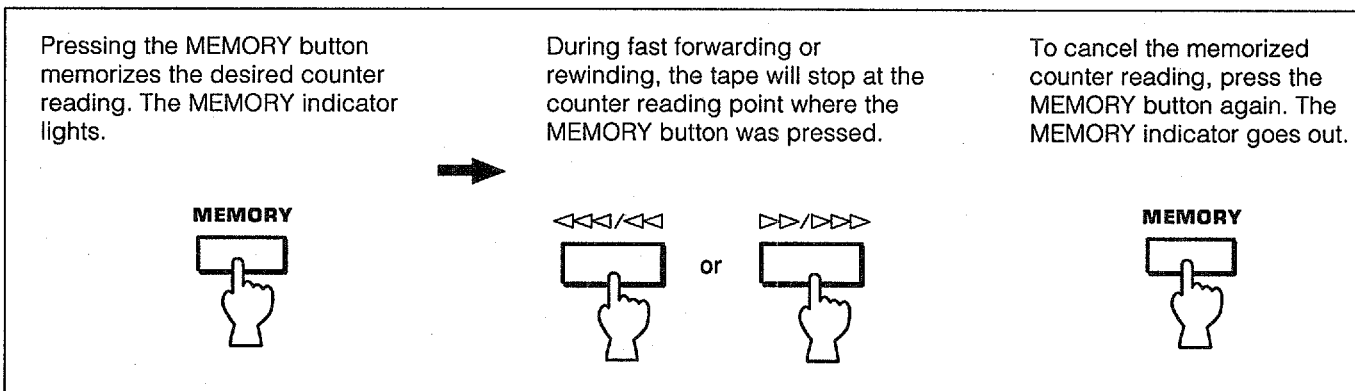
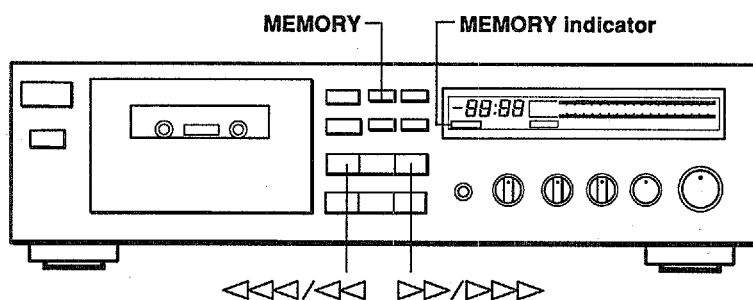



# RECORDING

## Preparation for recording

- Turn on the POWER switch.
- Set your amplifier or receiver to cassette deck function mode.

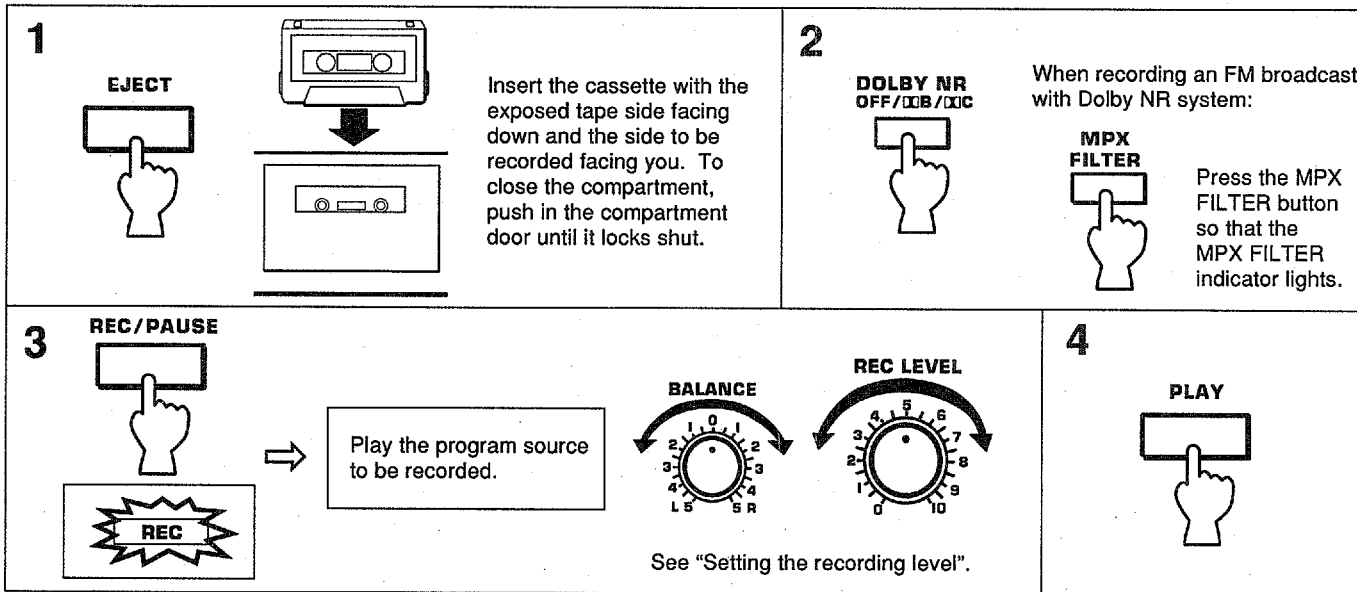
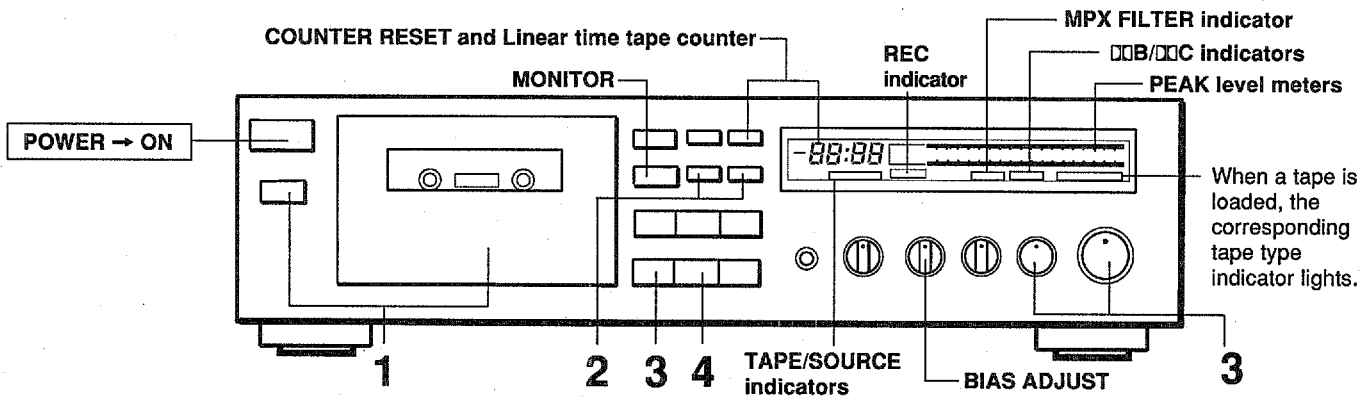

### DOLBY NR button setting (in step 2)

Each time this button is pressed, Dolby NR switches to □□B, to □□C, to OFF and back around to □□B.

**OFF:** No noise reduction.

**□□ B:** Recording sources with Dolby B NR. The □□B indicator lights.

**□□ C:** Recording sources with Dolby C NR. The □□C indicator lights.

- Dolby noise reduction is an extremely effective method of reducing undesirable background hiss on tapes. This unit incorporates both Dolby B NR and the newer Dolby C NR system. Dolby C NR is approximately twice as effective as the earlier Dolby B NR.

### MPX FILTER button setting (in step 2)

Recording an FM broadcast with Dolby NR system, press this button so that the **MPX FILTER** indicator lights.

- FM stations transmit a 19 kHz pilot signal in addition to the broadcast program. Sometimes this pilot signal may leak into the audio output depending on the tuner and broadcast conditions. This signal can cause improper operation of the Dolby NR systems. Activating the MPX filter will effectively remove the signal.

### To stop recording:

Press the **STOP** button.

### To stop recording temporarily:

Press the **REC/PAUSE** button. To resume recording, press the **PLAY** button.

### Linear time tape counter and COUNTER RESET button

Before starting recording, press the **COUNTER RESET** button to set the counter reading to "0:00". Use this counter as aid in locating a point on a tape.



### Bias adjustment

The BIAS ADJUST control is for fine adjustment of the recording bias. Normally, it is not necessary to adjust this control since the built-in Auto Tape Selector automatically adjusts the recording bias for different tape types.

However, if you feel that your recording needs further bias adjustment (to compensate for absent or distorted high frequencies), adjust this control to your liking.

When distortion is noticeable, attenuate the high frequencies.

**BIAS ADJUST**

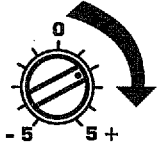

When high frequencies are absent, boost the high frequencies.

**BIAS ADJUST**

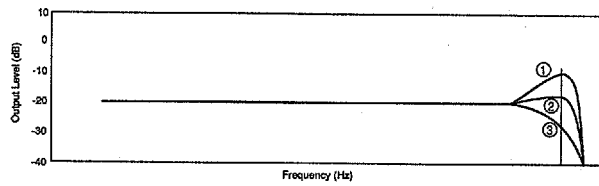
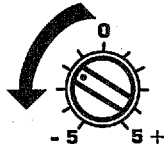

- ① Insufficient bias (Distortion is noticeable.)
- ② Optimum bias
- ③ Excessive bias (High frequencies are absent.)

### Setting the recording level (in step 3)

Play the loudest passage of the source to be recorded and watch the meter readings. Adjust the REC LEVEL control so that the highest peak is between +6 dB and +8 dB. Normally, it is best to adjust the BALANCE control such that the LEFT and RIGHT meter readings are even.

- The  mark indicates the Dolby noise reduction system standard level.

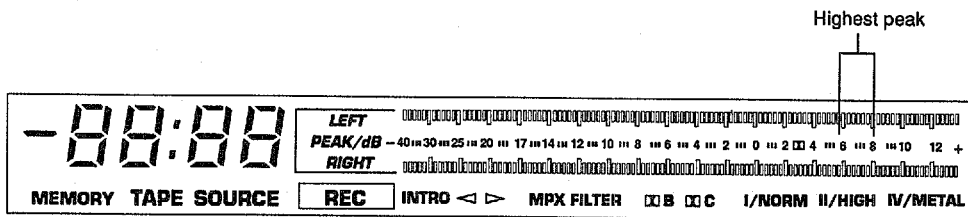

### Three head system

The three-head system allows the just-recorded sound to be monitored while recording. You can compare the difference between the recorded sound and the source sound by switching the monitor mode (SOURCE or TAPE) with the MONITOR button, so you can try to obtain a recording sound identical to the source sound.

To monitor the just recorded sound

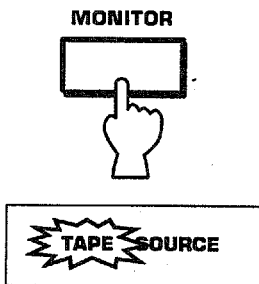

To monitor the sound to be recorded

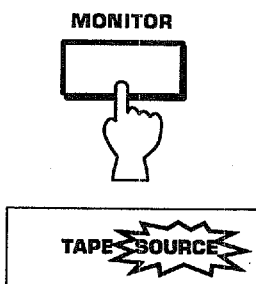

## RECORDING

### Rec mute operation - Inserting a blank space during recording

During recording

**MUTE/SEARCH**



Front panel

or

**REC MUTE**



Remote control transmitter

A 4-second blank interval is automatically recorded on the tape, and then the deck enters Rec/Pause mode. If a blank interval longer than 4 seconds is desired, keep pressing for as long as you want. When the MUTE/SEARCH button is released, the deck enters Rec/Pause mode after making a 4-second blank interval. To resume recording, press the PLAY button.

### Rec Return operation - To return to the point at which the recording previously started

During recording

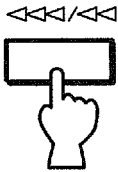

### 0-stop operation - To return to the "0:00" point

During recording

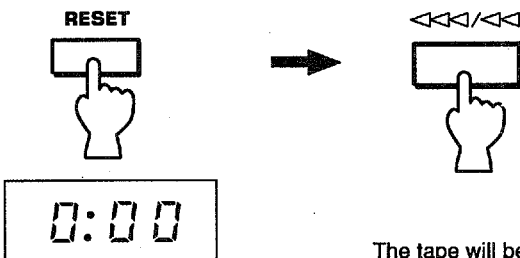

The "0:00" point is memorized.

The tape will be automatically rewound to the "0:00" point.

**NOTE:**

The tape will stop at the point slightly ahead of the "0:00" point. (-0:02)

#### **DOLBY HX PRO DYNAMIC BIAS SERVO SYSTEM**

This unit incorporates the Dolby HX Pro system which automatically controls the effective bias to reduce distortion and noise, improving high frequency response during recording. Tapes recorded with this system retain the same high quality even when played back on any other cassette deck.

Dolby noise reduction and HX Pro headroom extension manufactured under license from Dolby Laboratories Licensing Corporation, HX Pro originated by Bang & Olufsen.

"DOLBY", the double-D symbol  and "HX PRO" are trademarks of Dolby Laboratories Licensing Corporation.

# CASSETTE TAPES

## CASSETTE TAPES

There are many different types of cassette tapes available, however, they all conform to standard specifications so any brand may be used with the deck.

\* YAMAHA does not recommend the use of 120 minute length cassettes since the extreme thinness of the tape makes them susceptible to mechanical and recording problems.

- Classification of Cassette Tapes by Formulation  
Cassette tapes are available in four basic types depending on their formulation, or type of magnetic material and manufacturing process. These four types are commonly known as Normal (Type I/NORM), Chrome (Type II/HIGH <math>\langle CrO\_2 \rangle</math>), Ferrichrome (Type III/FeCr), and Metal (Type IV/METAL), and they each require specific tape deck adjustments for optimum performance.

## AUTO TAPE SELECTOR DETECTION SLOTS

The deck has a built-in Auto Tape Selector which automatically adjusts for the proper bias, level and equalization according to the tape formulation — all you have to do is load a cassette and the Auto Tape Selector does the rest.

The Auto Tape Selector determines what type of tape is loaded by sensing detector slots in the top of a tape shell. Each tape formulation has its own characteristic hole markings which has been standardized by the tape industry.

- Early model Metal (Type IV/Metal) tape formulation cassette shells do not have the slots for Auto Tape Selector operation. As a result, early model Metal type tapes recorded on another deck will be played back with the deck at the Chrome (Type II/HIGH <math>\langle CrO\_2 \rangle</math>) settings. YAMAHA does not recommend recording with this kind of tape on the deck.
- The deck does not have the required setting for Ferrichrome (Type III/FeCr) tape, since this tape formulation is not widely used. Should you use a Ferrichrome tape, it will be recorded and played back at the Normal (Type I/NORM) settings. And this will result in an unnatural high frequency emphasis. This effect may be compensated for somewhat by adjusting the BIAS ADJUST to the plus (+) direction during recording, or by using the PLAY TRIM tone control and/or the tone controls of your amplifier/receiver during playback.

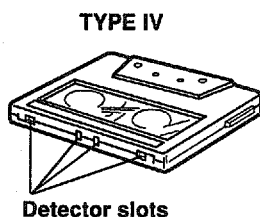
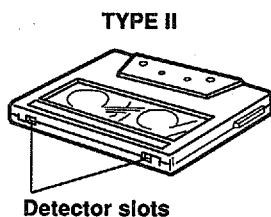

## PROTECTING YOUR RECORDINGS

All cassette tapes are provided with erasure protection holes to prevent accidental erasure of recorded contents. There is a small tab covering the hole on each cassette, and it should be broken off after recording a tape. Without this tab covering the hole, it is impossible to record onto that tape. Thus, you can safely protect a recording for as long as you wish without fear of accidental erasure. Should you wish to use a cassette tape protected in this way for recording, simply covering the hole with adhesive tape will permit erasure and re-recording.

- When using Chrome (Type II/HIGH <math>\langle CrO\_2 \rangle</math>) or Metal (Type IV/METAL) tapes, make sure you do not cover the hole intended for the Auto Tape Selector operation.

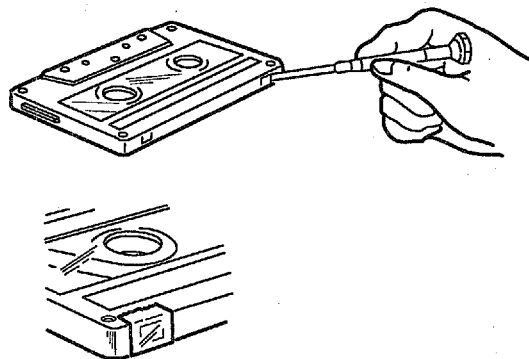

## TAKING UP SLACK IN THE TAPE

As a precaution against tape entanglement and damage, before inserting cassettes into the deck, remove any slack in the tape. This is accomplished by inserting a pencil, pen or similar object into one of the spools and gently winding it until all the slack is removed. You do not have to wind it too tightly.

Be careful not to touch the tape part itself. It is very delicate and touching it may damage the tape and its recorded contents.

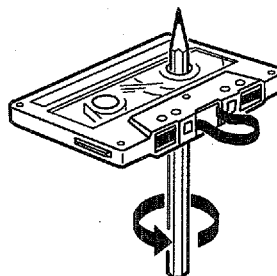

## STORING CASSETTES

After putting a cassette tape back into its case, store in a location away from exposure to direct sunlight, humidity, high temperatures, and magnetic fields (away from television sets, speakers, etc.). High temperatures and humidity will damage the tape itself, while exposure to magnetic fields may cause a loss of recorded material. Avoid touching the tape surface with your fingers, since dirt or finger oil will contaminate the deck's heads.

## MAINTENANCE

### CLEANING OF TAPE PATH

The continued high quality performance of your deck is dependent upon periodic cleaning of the heads, capstan, pinch roller, and all surfaces over which the tape travels. Normal use will cause an accumulation of dirt and dust on the heads, capstans, and pinch rollers. This can lead to poor sound quality, drop outs (intervals with no sound), unsteady tape speed, loss of high frequency response, etc.

Thus, clean the heads and all surfaces over which the tape travels with commercially available cleaning cassette and fluid type cleaners.

Inside of the cassette compartment

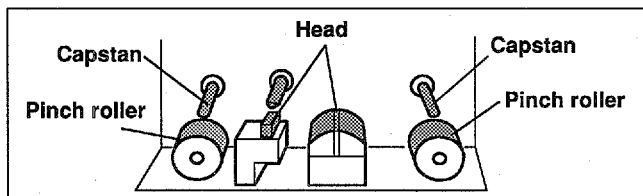

### DEMAGNETIZATION

After 20-30 hours of use, enough residual magnetism will have built up on the heads to cause poor high frequency reproduction. At this time you should use a commercially available head demagnetizer.

- When demagnetizing the heads, be sure to follow the instructions of the head demagnetizer carefully.

## REMOTE CONTROL TRANSMITTER

The keys which have the same names and marks are identical to the buttons on the cassette deck.

### BATTERY INSTALLATION

- ① Press the lid's locking tab down and, at the same time, pull out the battery compartment lid in the direction of the arrow.
- ② Install the batteries (size "AAA", R03) with correct polarities. Follow the diagram in the compartment.
- ③ Position the bottom portion of the compartment lid in place, and push the top portion of the lid in until it clicks into place.

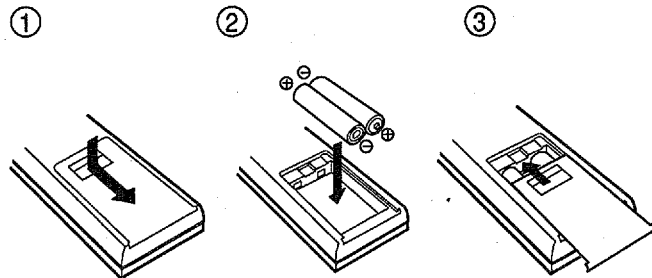

### REMOTE CONTROL OPERATION RANGE

The remote control transmitter uses infrared light to control the unit. Therefore, to function properly, there must be a clear, unobstructed path between the transmitter and the sensor on the deck. The normal operating range is about 7 meters (23 feet) and within 30 degrees perpendicular to the front panel.

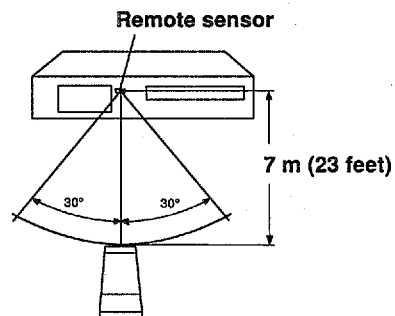

### BATTERY REPLACEMENT

When the operating distance of the remote control noticeably decreases, the batteries are exhausted. Immediately replace the batteries with new ones.

- Do not use an old battery together with a new one.
- Install the same type of batteries at the same time. Do not use different kinds of batteries (carbon, alkaline, Ni-Cad, etc.) at the same time even though they are the same shape.
- There are two kinds of batteries in the market: available rechargeable and non-rechargeable. Read the caution labels on the battery carefully.

### BATTERY SAFETY

Incorrect use of the battery can cause leakage or explosion. Proper handling and use of batteries are as follows:

- When the remote control will not be used for an extended period of time, remove the batteries.
- Never disassemble, heat or throw a battery into a fire.
- Do not connect (short circuit) the (+) and (-) poles of a battery with a piece of wire, metal, etc. In case of leakage, thoroughly wipe off all the electrolyte from the battery compartment and install new batteries.

## TROUBLESHOOTING

If your cassette deck fails to operate normally, check the following table. It lists common operating errors and simple measures which you can take to correct the problem. If it cannot be corrected, or the symptom is not listed, disconnect the deck's power cord and contact your local YAMAHA dealer or service center for help.

Fault	Cause	Cure
<b>Tape doesn't move in recording or playback.</b>	<ul style="list-style-type: none"> <li>● Power plug not properly plugged in.</li> <li>● End of tape.</li> <li>● Cassette shell is warped or damaged.</li> </ul>	<ul style="list-style-type: none"> <li>● Reinsert plug properly.</li> <li>● Rewind tape or flip it over.</li> <li>● Do not play damaged tapes.</li> </ul>
<b>REC/PAUSE button fails to function.</b>	<ul style="list-style-type: none"> <li>● No cassette tape loaded.</li> <li>● Protective tabs are broken off.</li> </ul>	<ul style="list-style-type: none"> <li>● Load a cassette tape.</li> <li>● Change tape or cover protective hole with cellophane tape.</li> </ul>
<b>Sounds become faint and sometimes inaudible.</b>	<ul style="list-style-type: none"> <li>● Head is dirty.</li> <li>● Head is magnetized.</li> <li>● Tape is damaged or of poor quality.</li> </ul>	<ul style="list-style-type: none"> <li>● Clean head.</li> <li>● Demagnetize head using head demagnetizer.</li> <li>● Change to a different tape.</li> </ul>
<b>Recorded sound is distorted.</b>	<ul style="list-style-type: none"> <li>● Tape is bad (stretched or deformed, etc.).</li> <li>● Cassette shell is warped.</li> <li>● Recording level is too high.</li> </ul>	<ul style="list-style-type: none"> <li>● Replace with a fresh tape.</li> <li>● A warped cassette shell cannot be fixed. Replace with another tape and test.</li> <li>● Check input level with signal level meter and use lower rec level when recording.</li> </ul>
<b>Tape is playing back, but no sound is heard.</b>	<ul style="list-style-type: none"> <li>● Faulty connection between deck and stereo amplifier/receiver.</li> </ul>	<ul style="list-style-type: none"> <li>● Check and secure connections.</li> </ul>
<b>Excessive noise.</b>	<ul style="list-style-type: none"> <li>● Head is dirty.</li> <li>● Head is magnetized.</li> <li>● Worn out or poor quality tape.</li> <li>● Connection(s) improperly made.</li> <li>● Affected by external electrical noise.</li> </ul>	<ul style="list-style-type: none"> <li>● Clean head.</li> <li>● Demagnetize head with head demagnetizer.</li> <li>● Change to better tape.</li> <li>● Check input and output connections and reinsert properly.</li> <li>● Move away from electrical appliances (TV, fluorescent light, electric blanket, etc.).</li> </ul>
<b>Excessive wow (wavering of the sound).</b>	<ul style="list-style-type: none"> <li>● Dirty capstan, pinch roller, etc., or poor tape.</li> <li>● Tape is wound unevenly.</li> </ul>	<ul style="list-style-type: none"> <li>● Clean capstan, pinch roller, or change to better tape.</li> <li>● Rewind tape.</li> </ul>
<b>Tape stops in the middle of recording or playback.</b>	<ul style="list-style-type: none"> <li>● Slack tape, or tape spillage wound around capstan.</li> </ul>	<ul style="list-style-type: none"> <li>● Insert pencil in hole in cassette shell and turn to take up slack.</li> </ul>
<b>Fails to record.</b>	<ul style="list-style-type: none"> <li>● REC LEVEL control is set too low.</li> <li>● Protective tabs are broken off.</li> </ul>	<ul style="list-style-type: none"> <li>● Adjust REC LEVEL control.</li> <li>● Change tape or cover protective hole with cellophane tape.</li> </ul>
<b>Search does not operate.</b>	<ul style="list-style-type: none"> <li>● Recorded section is too short.</li> <li>● Recorded section has low-level portions.</li> <li>● Conversation, etc. has been recorded.</li> </ul>	<ul style="list-style-type: none"> <li>● Blank sections must be at least 4 seconds long.</li> </ul>
<b>High frequencies in the playback sound are emphasized and unpleasant to listen to, and noise level (hiss) is also high.</b>	<ul style="list-style-type: none"> <li>● Dolby NR-recorded tape is played back in OFF position.</li> </ul>	<ul style="list-style-type: none"> <li>● Playback in appropriate Dolby NR position.</li> </ul>

Fault	Cause	Cure
Playback sound is muffled and high frequencies are inaudible.	<ul style="list-style-type: none"> <li>Normally-recorded tape is played back in Dolby NR.</li> <li>Heads are dirty.</li> <li>Heads are magnetized.</li> </ul>	<ul style="list-style-type: none"> <li>Playback in OFF position.</li> <li>Clean heads and carry out demagnetization with headdemagnetizer.</li> </ul>
When playing back tapes recorded on other decks, meter deflections are greater (smaller) than when recording.	<ul style="list-style-type: none"> <li>Basic levels are different for different cassette decks.</li> </ul>	<ul style="list-style-type: none"> <li>This is not a fault.</li> </ul>

## SPECIFICATIONS

<b>Track Configuration</b> .....	4 track, 2 channel stereo
<b>Motor</b> .....	DC servo motor (capstan) Flat torque DC motor (reel) DC servo motor (assist)
<b>Head</b> .....	Recording: hard permalloy Playback: hard permalloy Erase: double-gap Ferrite head
<b>Rapid Transport</b> .....	70 sec. (C-60) at high speed, 50 sec. (C-60)
<b>Wow and Flutter</b>	
WRMS .....	less than 0.05%
W.Peak .....	less than ±0.08%
<b>Signal-to-Noise Ratio</b>	
(Dolby NR off) .....	better than 60 dB
(Dolby B NR on) .....	better than 68 dB
(Dolby C NR on) .....	better than 76 dB
<b>Frequency Response</b>	
Normal tape (-20 dB) .....	20 ~ 18,000 Hz ±3 dB
CrO <sub>2</sub> tape (-20 dB) .....	20 ~ 19,000 Hz ±3 dB
Metal tape (-20 dB) .....	20 ~ 21,000 Hz ±3 dB
<b>Harmonic Distortion</b>	
Normal tape .....	less than 0.8%
Chrome tape .....	less than 0.8%
Metal tape .....	less than 0.8%
<b>Input Sensitivity/Impedance</b>	
Line .....	75 mV/50 k-ohms
<b>Output Level</b>	
Line .....	360 mV/1.8 k-ohms
Phones .....	0.6 mW/8 ohms
<b>Channel Separation (3150 Hz)</b> .....	40 dB
<b>Cross Talk (125 Hz)</b> .....	55 dB

### GENERAL

#### Power Supplies

U.S.A. and Canada model ..... 120 V, 60 Hz

Europe model ..... 230 V, 50 Hz

U.K. model and Australia model ..... 240 V, 50 Hz

Other model ..... 110/120/220/240 V, 50/60 Hz

**Power Consumption** ..... 17 W

**Dimensions (W x H x D)** ..... 435 x 122 x 273 mm  
(17-1/8" x 4-13/16" x 10-3/4")

**Weight** ..... 4.6 kg (10 lbs. 2 oz.)

#### Accessories

Output cord ..... 1

Remote control transmitter ..... 1

Batteries ..... 2

\* Specifications subject to change without notice.





# YAMAHA

---

**YAMAHA ELECTRONICS CORPORATION, USA** 6722 ORANGETHORPE AVE., BUENA PARK, CALIF. 90620, U.S.A.  
**YAMAHA CANADA MUSIC LTD.** 135 MILNER AVE., SCARBOROUGH, ONTARIO M1S 3R1, CANADA  
**YAMAHA ELECTRONIK EUROPA G.m.b.H.** SIEMENSSTR. 22-34, D-2084 RELINGEN BEI HAMBURG, F.R. OF GERMANY  
**YAMAHA ELECTRONIQUE FRANCE S.A.** 17 RUE DES CAMPANULES, LOGNES 77321 MARNE LA VALLEE CEDEX 2 FRANCE  
**YAMAHA ELECTRONICS (UK) LTD.** YAMAHA HOUSE, 200 RICKMANSWORTH ROAD WATFORD, HERTS WD1 7JS, ENGLAND  
**YAMAHA SCANDINAVIA A.B.** J A WETTERGRENS GATA 1, BOX 30053, 400 43 VASTRA FRÖLUNDA, SWEDEN  
**YAMAHA MUSIC AUSTRALIA PTY, LTD.** 17-33 MARKET ST., SOUTH MELBOURNE, 3205 VIC., AUSTRALIA

**YAMAHA CORPORATION**

10-1 NAKAZAWA-CHO, HAMAMATSU, JAPAN

VK24740-0 BWWB, B&C Printed in Japan