



Electone® *STAGEA*®
ELS-01/01C typeU

Owner's Manual

STAGEA

PRECAUTIONS

PLEASE READ CAREFULLY BEFORE PROCEEDING

* Please keep this manual in a safe place for future reference.



WARNING

Always follow the basic precautions listed below to avoid the possibility of serious injury or even death from electrical shock, short-circuiting, damages, fire or other hazards. These precautions include, but are not limited to, the following:

Power supply/Power cord

- Only use the voltage specified as correct for the instrument. The required voltage is printed on the name plate of the instrument.
- Check the electric plug periodically and remove any dirt or dust which may have accumulated on it.
- Do not place the power cord near heat sources such as heaters or radiators, and do not excessively bend or otherwise damage the cord, place heavy objects on it, or place it in a position where anyone could walk on, trip over, or roll anything over it.

Do not open

- Do not open the instrument or attempt to disassemble the internal parts or modify them in any way. The instrument contains no user-serviceable parts. If it should appear to be malfunctioning, discontinue use immediately and have it inspected by qualified Yamaha service personnel.

Water warning

- Do not expose the instrument to rain, use it near water or in damp or wet conditions, or place containers on it containing liquids which might spill into any openings. If any liquid such as water seeps into the instrument, turn off the power immediately and unplug the power cord from the AC outlet. Then have the instrument inspected by qualified Yamaha service personnel
- Never insert or remove an electric plug with wet hands.

Fire warning

- Do not put burning items, such as candles, on the unit.
A burning item may fall over and cause a fire.

If you notice any abnormality

- If the power cord or plug becomes frayed or damaged, or if there is a sudden loss of sound during use of the instrument, or if any unusual smells or smoke should appear to be caused by it, immediately turn off the power switch, disconnect the electric plug from the outlet, and have the instrument inspected by qualified Yamaha service personnel.



CAUTION

Always follow the basic precautions listed below to avoid the possibility of physical injury to you or others, or damage to the instrument or other property. These precautions include, but are not limited to, the following:

Power supply/Power cord

- When removing the electric plug from the instrument or an outlet, always hold the plug itself and not the cord. Pulling by the cord can damage it.
- Remove the electric plug from the outlet when the instrument is not to be used for extended periods of time, or during electrical storms.
- Do not connect the instrument to an electrical outlet using a multiple-connector. Doing so can result in lower sound quality, or possibly cause overheating in the outlet.

Location

- Do not expose the instrument to excessive dust or vibrations, or extreme cold or heat (such as in direct sunlight, near a heater, or in a car during the day) to prevent the possibility of panel disfiguration or damage to the internal components.
- Do not use the instrument in the vicinity of a TV, radio, stereo equipment, mobile phone, or other electric devices. Otherwise, the instrument, TV, or radio may generate noise.
- Do not place the instrument in an unstable position where it might accidentally fall over.
- Before moving the instrument, remove all connected cables.
- When setting up the instrument, make sure that the AC outlet you are using is easily accessible. If some trouble or malfunction occurs, immediately turn off the power switch and disconnect the plug from the outlet. Even when the power switch is turned off, electricity is still flowing to the product at the minimum level. When you are not using the product for a long time, make sure to unplug the power cord from the wall AC outlet.
- Do not place the instrument against a wall (allow at least 3 cm/one-inch from the wall), since this can cause inadequate air circulation, and possibly result in the instrument overheating.

Connections

- Before connecting the instrument to other electronic components, turn off the power for all components. Before turning the power on or off for all components, set all volume levels to minimum. Also, be sure to set the volumes of all components at their minimum levels and gradually raise the volume controls while playing the instrument to set the desired listening level.

Maintenance

- When cleaning the instrument, use a soft, dry cloth. Do not use paint thinners, solvents, cleaning fluids, or chemical-impregnated wiping cloths.

Handling caution

- Take care that the key cover does not pinch your fingers, and do not insert a finger or hand in any gaps on the key cover or instrument.
- Never insert or drop paper, metallic, or other objects into the gaps on the key cover, panel or keyboard. If this happens, turn off the power immediately and unplug the power cord from the AC outlet. Then have the instrument inspected by qualified Yamaha service personnel.
- Do not place vinyl, plastic or rubber objects on the instrument, since this might discolor the panel or keyboard.
- Do not rest your weight on, or place heavy objects on the instrument, and do not use excessive force on the buttons, switches or connectors.
- Do not operate the instrument or headphones for a long period of time at a high or uncomfortable volume level, since this can cause permanent hearing loss. If you experience any hearing loss or ringing in the ears, consult a physician.

Using the bench

- Do not place the bench in an unstable position where it might accidentally fall over.
- Do not play carelessly with or stand on the bench. Using it as a tool or step-ladder or for any other purpose might result in accident or injury.
- Only one person should sit on the bench at a time, in order to prevent the possibility of accident or injury.
- If the bench screws become loose due to extensive long-term use, tighten them periodically using the included tool.

Saving data

Saving and backing up your data

- Always save data to a USB flash memory or other external media, in order to help prevent the loss of important data due to a malfunction or user operating error.

Backing up the external media

- To protect against data loss through media damage, we recommend that you save your important data onto two external media.

Yamaha cannot be held responsible for damage caused by improper use or modifications to the instrument, or data that is lost or destroyed.

Always turn the power off when the instrument is not in use.

The serial number of this product may be found on the bottom of the unit. You should note this serial number in the space provided below and retain this manual as a permanent record of your purchase to aid identification in the event of theft.

Model No. ELS-01U/ELS-01CU

Serial No.

(bottom)

Congratulations!

You are the proud owner of a fine electronic organ, the Electone STAGEA ELS-01/01C typeU (hereafter ELS-01/01C).

The Yamaha Electone combines the most advanced tone generation technology with state-of-the-art digital electronics and features to give you stunning sound quality with maximum musical versatility.

In order to make the most of your Electone and its extensive performance potential, we urge you to read the manual thoroughly while trying out the various features described.

Keep the manual in a safe place for later reference.

Accessories

- Bench
- Owner's Manual
- Playing the ELS-01/01C — Tutorial Guidebook
- Product ID card

Main Features

Wide Variety of Registration Menus

page 19

The Registration Menu buttons feature a total of 240 Registrations, allowing you to instantly set up the Electone for playing your favorite type of music. The ELS-01C contains even more — an additional 60 Registrations that utilize the expressive VA Voices and Organ Flute Voices. The Registrations in Registration Menu are divided into five basic categories for ease of selection. Moreover, you can edit any of the Registrations and customize them to fit your own performance needs.

Richly textured, four-layer AWM Voices and High Quality Digital Effects

pages 22 and 50

The ELS-01 contains a huge amount of exceptionally high-quality Voices – 415 altogether – created with the AWM (Advanced Wave Memory) tone generation system. The ELS-01C adds to that 94 VA (Virtual Acoustic) Voices and a virtually limitless variety of Organ Flute Voices. The authentic touch response keyboard lets you play these Voices with all the expressiveness and control of an actual acoustic instrument. What's more, there are 183 different effect types in 15 categories that you can apply to each Voice section — letting you enhance and even completely change the character of the Voices, without having to use the Voice Edit features.

Dynamic, Contemporary Rhythms and Auto Accompaniment

page 51

The exceptionally wide selection of 274 rhythms lets you choose exactly the rhythm you need in your performance. Each rhythm contains 15 variations (sections) – such as Main, Fill In, Intro, Ending, and Break – that you can easily switch while you play, to make your performance even more dynamic and professional. Each rhythm has its own matching accompaniment divided into five instrument parts, providing basic backing as well as embellishments.

Large, 6.5-inch TFT-LCD with Intuitive Touch Panel Operation

page 12

This large LCD display not only lets you clearly see a wide selection of settings and parameters at almost any angle, it also serves as a touch control panel — letting you intuitively make selections and adjust settings simply by touching the screen! Once you touch a setting, you can even adjust it in finer detail if necessary with the Data Control dial.

The ELS-01/01C is compatible with the following formats.



“GM (General MIDI)” is one of the most common Voice allocation formats. “GM System Level 2” is a standard specification that enhances the original “GM” and improves Song data compatibility. It provides for increased polyphony, greater Voice selection, expanded Voice parameters, and integrated effect processing.



XG is a major enhancement of the GM System Level 1 format, and was developed by Yamaha specifically to provide more Voices and variations, as well as greater expressive control over Voices and effects, and to ensure compatibility of data well into the future.



GS was developed by the Roland Corporation. In the same way as Yamaha XG, GS is a major enhancement of the GM specifically to provide more Voices and Drum kits and their variations, as well as greater expressive control over Voices and effects.



The Style File Format combines all of Yamaha’s auto accompaniment know-how into a single unified format.



[ELS-01C only] Products bearing the SONDIUS-XG logo are licensed under patents of Stanford University and Yamaha as listed on the internet web site, <<http://www.sondius-xg.com>>.



This product utilizes NF, an embedded Internet browser from ACCESS Co., Ltd. NF is used with the patented LZW, licensed from Unisys Co., Ltd. NF may not be separated from this product, nor may it be sold, lent or transferred in any way. Also, NF may not be reverse-engineered, reverse-compiled, reverse-assembled or copied.

This software includes a module developed by the Independent JPEG Group.

- The bitmap fonts used in this instrument have been provided by and are the property of Ricoh Co., Ltd.
- This product incorporates and bundles computer programs and contents in which Yamaha owns copyrights or with respect to which it has license to use others’ copyrights. Such copyrighted materials include, without limitation, all computer software, styles files, MIDI files, WAVE data and sound recordings. Any unauthorized use of such programs and contents outside of personal use is not permitted under relevant laws. Any violation of copyright has legal consequences. **DON’T MAKE, DISTRIBUTE OR USE ILLEGAL COPIES.**
- Copying of the commercially available music sequence data and/or digital audio files is strictly prohibited except for your personal use.
- Electone and STAGEA are the trademarks of Yamaha Corporation.
- The company names and product names in this Owner’s Manual are the trademarks or registered trademarks of their respective companies.
- The illustrations and LCD screens as shown in this owner’s manual are for instructional purposes only, and may appear somewhat different from those on your instrument.
- The panel illustrations and LCD screens shown in this owner’s manual are taken from the ELS-01C, Version 1.7.
- The pan flute and sitar, shown in the displays of the ELS-01/01C, are on display at the Hamamatsu Museum of Musical Instruments.

Contents

Accessories	4
Main Features	5

Panel Layout 8

Front Panel	8
LCD Display/Display Select	10
Overview	10

1 Quick Introductory Guide 11

Getting Started	11
Using the LCD Display	12
LCD Display Settings	15
Voice Display	17
Registration Menu	19
Confirming the Version of Your Electone	21
Factory Set (Initializing the Electone)	21

2 Voices 22

Voices for each keyboard	22
Selecting Voices with the Voice buttons	23
Selecting Voices from the User buttons	28
Voice List	30

3 Organ Flutes (ELS-01C) 35

4 Voice Controls and Effects 38

Selecting from the Voice Condition display	39
Selecting from the panel	43
Effect List	50

5 Rhythm/Keyboard Percussion 51

Selecting rhythms with the Rhythm buttons	51
Selecting rhythms from the User buttons	58
Rhythm List	59
Accompaniment	61
Automatic Accompaniment – Auto Bass Chord (A.B.C.)	62
Melody On Chord (M.O.C.)	64
Keyboard Percussion	65

6 Registration Memory 80

Storing Registrations	80
Selecting Registrations	82
Saving the Registration data to USB flash memory	84
Initializing Registration Memory	85
Registration Shift	85
Unifying a specific parameter	90
Copying Registrations	93

7 Music Data Recorder (MDR) 95

Calling Up the M.D.R. Display	95
Using the LCD Display	96
Formatting External Media	102
Selecting a Song	103
Recording	105
Changing the Song Name	108
Saving Registrations as Registration Data (File)	111
Recalling Recorded Registrations	115
Playing Back a Song	117
Displaying the Score	122
Other Functions (Tools)	124

8 Voice Edit 131

Voice Structure	131
Editing a Voice	132
Saving the edited Voice	141
Quitting Voice Edit	142
Recalling an Edited Voice	142

9 Rhythm Program 143

Outline of the Rhythm Programming Operation	143
Rhythm Pattern Program	144
Rhythm Sequence Program	174
Saving Rhythm Pattern and Rhythm Sequence Data to external media	184

10 Footswitches, Knee Lever and Expression Pedals 185

Footswitches	185
Knee Lever	188
Expression Pedals	190

11 Transpose and Pitch Controls 193

12 Internet Direct Connection 194

Connecting the Instrument to the Internet	194
Accessing the Website from the Electone	195
About the Internet Settings Display	203
Exiting from the Internet Display	206
Initializing Internet Settings	206
Glossary of Internet Terms	207

13 Connections 208

Accessory Jacks and Controls	208
Connection Examples – External Devices	211
Connection with Computer	217
MIDI	218
MIDI Control	221

14 Appendix 223

Bench Assembly	223
Installing Optional Hardware	224
MIDI Data Format	226
Troubleshooting	241
Specifications	244
Index	246

1 Quick Introductory Guide

2 Voices

3 Organ Flutes (ELS-01C)

4 Voice Controls and Effects

5 Rhythm/Keyboard Percussion

6 Registration Memory

7 Music Data Recorder (MDR)

8 Voice Edit

9 Rhythm Program

10 Footswitches, Knee Lever and Expression Pedals

11 Transpose and Pitch Controls

12 Internet Direct Connection

13 Connections

14 Appendix

Panel Layout

Front Panel

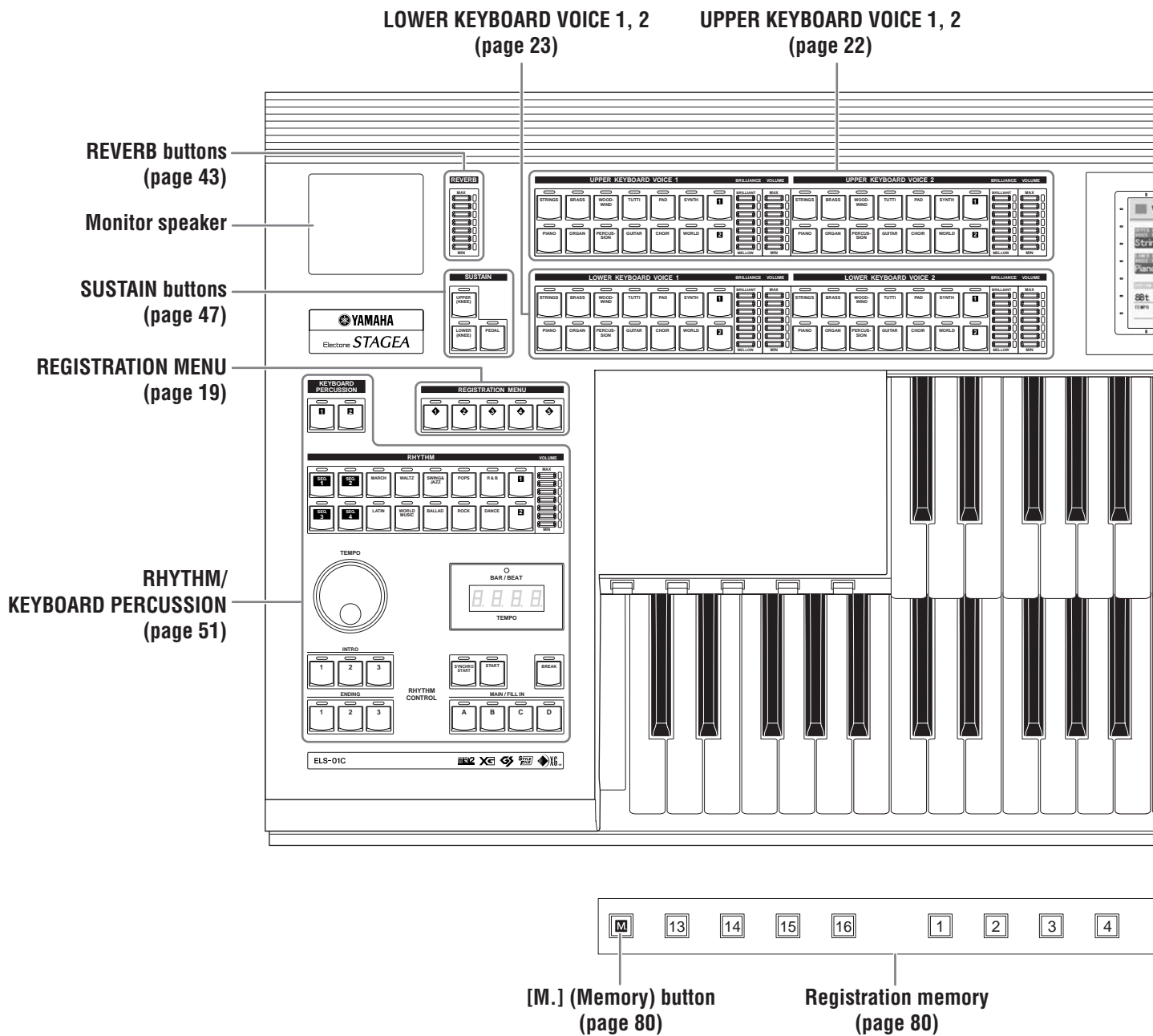

LCD display/
DISPLAY SELECT
(page 10)

PEDAL VOICE 1, 2
(page 23)

LEAD VOICE 1, 2
(page 22)

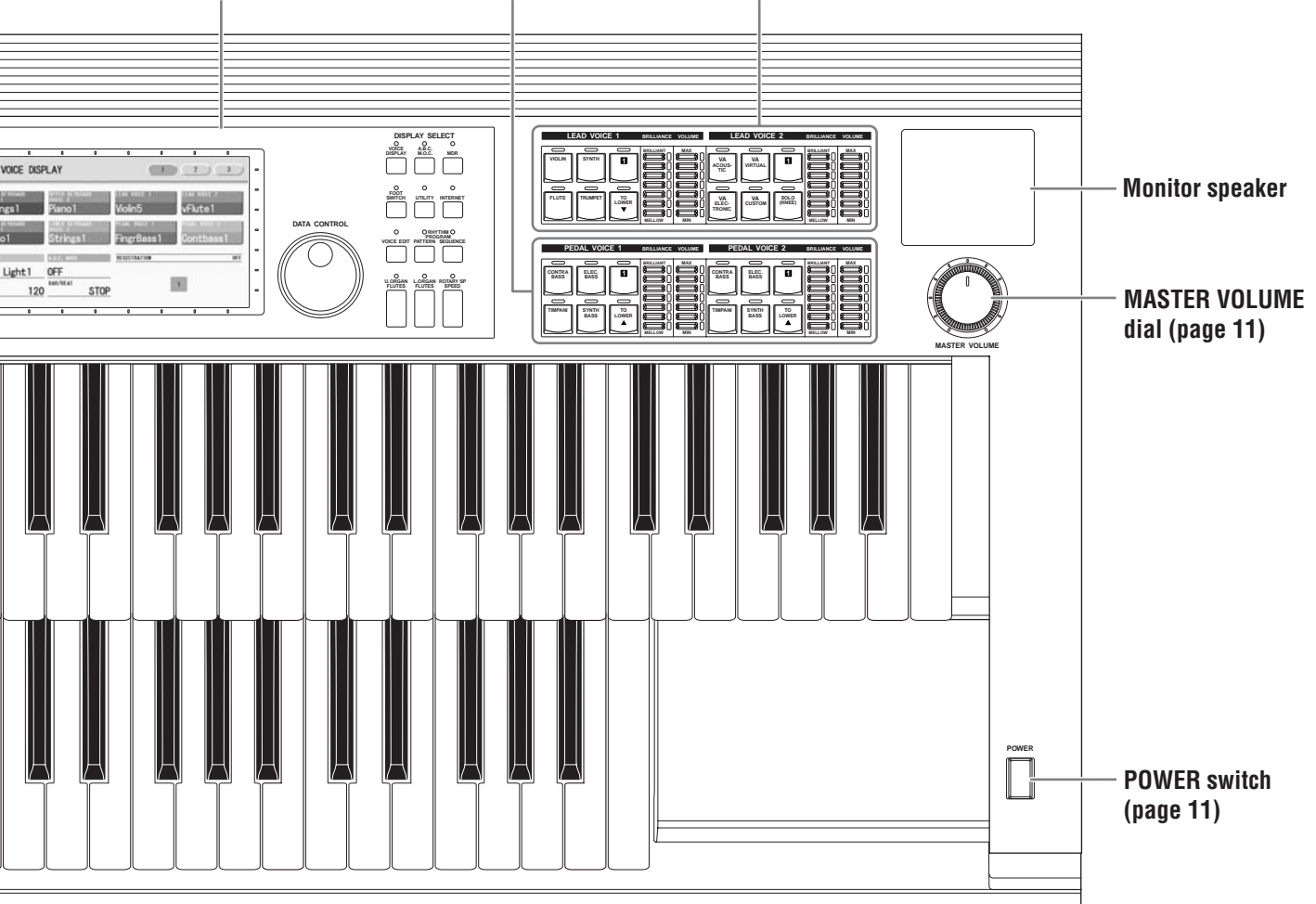

Monitor speaker

MASTER VOLUME
dial (page 11)

POWER switch
(page 11)



[D.] (Disable) button
(page 82)

LCD Display/Display Select

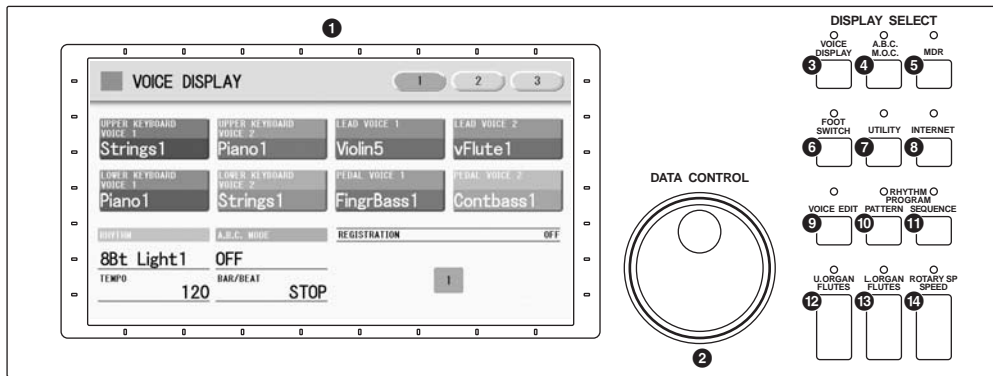

- 1** LCD display (touch-panel) page 12
- 2** DATA CONTROL dial page 14
- 3** [VOICE DISPLAY] button page 17
- 4** [A.B.C./M.O.C.] button pages 62, 64
- 5** [MDR] button page 95
- 6** [FOOT SWITCH] button pages 86, 185
- 7** [UTILITY] button pages 15, 191, 193, 221
- 8** [INTERNET] button page 195
- 9** [VOICE EDIT] button page 133
- 10** [PATTERN] button page 144
- 11** [SEQUENCE] button page 174
- 12** [U. ORGAN FLUTES] button page 35
- 13** [L. ORGAN FLUTES] button page 35
- 14** [ROTARY SP SPEED] button page 48

Overview

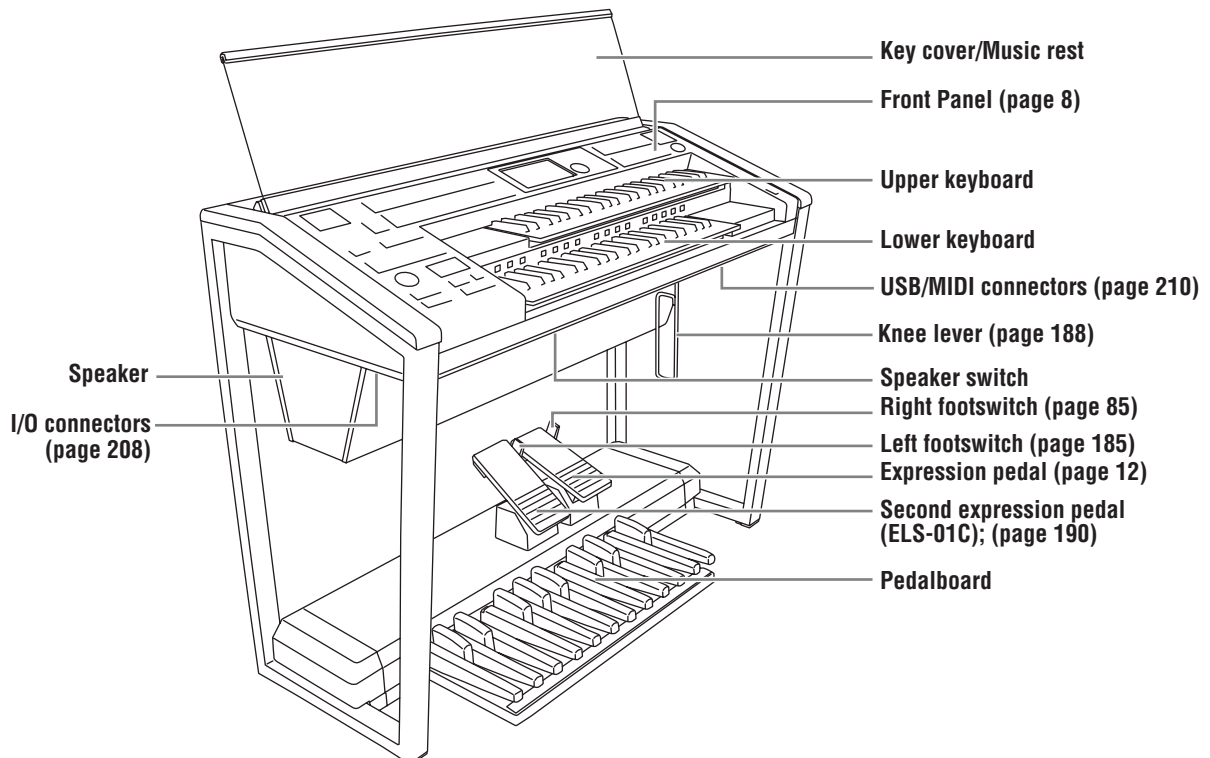

Quick Introductory Guide

Whether you are an advanced performer or have never touched an electronic keyboard in your life, we recommend that you take the time to go through this basic section. It shows you in the simplest possible manner how to start playing your Electone.

Contents

1 Getting Started	11	4 Voice Display	17
2 Using the LCD Display	12	5 Registration Menu	19
• Changing the Display Page	12	• Selecting Registrations from the Registration Menu	19
• Pressing Buttons on the Display	13	• Registration Menu List	20
• Adjusting Parameter Values by Using the Display Sliders	14	6 Confirming the Version of Your Electone	21
3 LCD Display Settings	15	7 Factory Set (Initializing the Electone)	21
• Selecting the Display Language	15		
• Muting the Touch Panel Sound	16		
• Adjusting the Display Brightness	16		

1 Getting Started

- 1 Plug the power cord into an appropriate electrical outlet.



Only use the voltage specified as correct for the Electone. The required voltage is printed on the name plate of the Electone. Yamaha products are manufactured specifically for the supply voltage in the area where they are to be sold. If you intend to use the instrument in another location, or if any doubt exists about the supply voltage, please consult with a qualified technician.

- 2 Make sure that the **POWER** switch of the speaker is set to on. If you are using the ELS-01C, also set the **REAR SPEAKER** switch to on (not available on the ELS-01).



NOTE

When using the rear speaker, place the Electone against a wall, allowing about 20 cm from the wall for optimum sound.

- 3 Turn on the Electone by pressing the **POWER** switch.

POWER

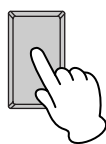

- 4 Set the **MASTER VOLUME** control. The **MASTER VOLUME** control is an overall control that affects the volume of the entire instrument.



NOTE

You do not need to switch the power of the speaker on/off whenever you use the instrument. If you want, you can always keep it on and turn off the power by pressing the main **POWER** switch of the instrument.

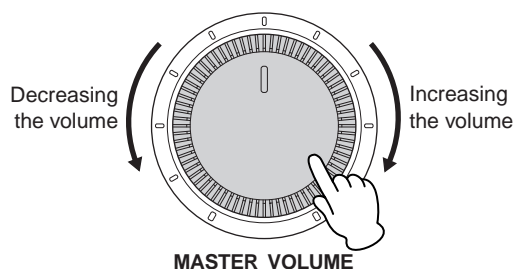

5 Press the Expression pedal down with your foot.

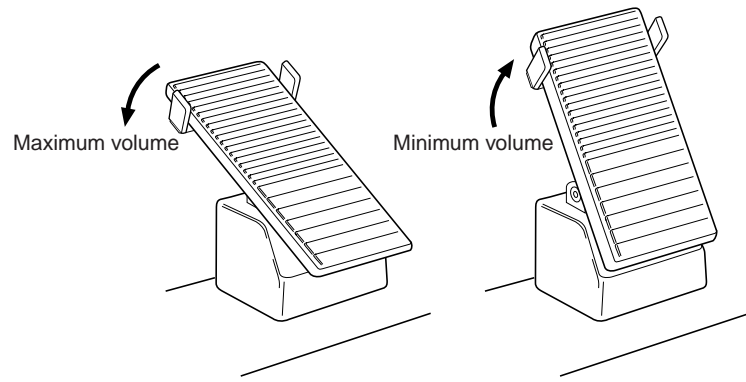

2 Using the LCD Display



NOTE

When cleaning the display, use a soft, dry cloth.



Do not use any sharp or hard tools to operate the touch panel. Doing so may damage the display.

This instrument features a special touch panel that allows you to change the parameters by simply touching the ‘virtual’ buttons or sliders on the display. (Please note that two or more parameters cannot be operated simultaneously.)

You can also use the Data Control dial to make fine changes to the parameter value shown in the display.

Changing the Display Page

There are some oval-shaped numbered buttons at the top right of the display. Pressing these buttons changes the “page” of the display. The selected page’s button turns orange.

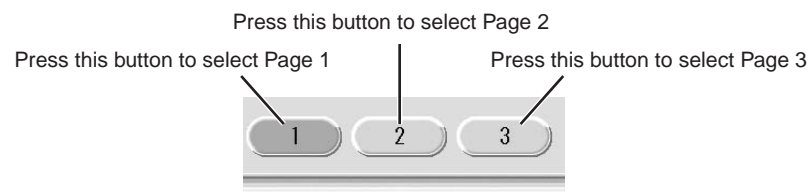
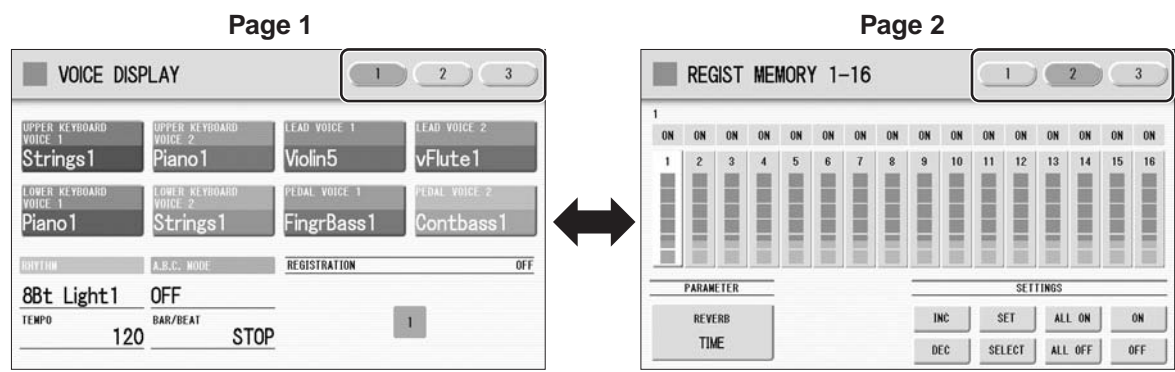

Pressing Buttons on the Display

There are three types of buttons: those that select a function, those that switch a function on/off, and those that open a list or menu of parameters. To select the desired function, simply press the button in the display directly.

For switching on/off or opening a parameter list, see the instructions below.

To switch the function on or off:

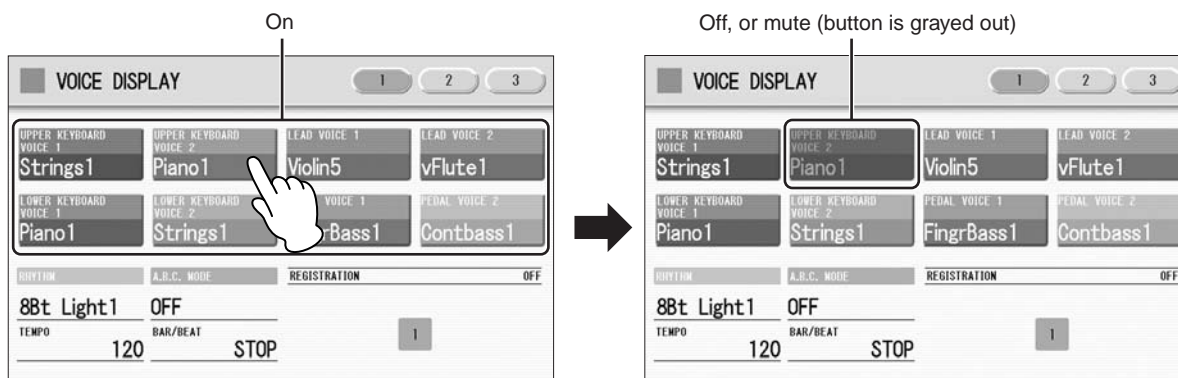

You can independently mute each Voice section in the Voice Display, each accompaniment part in Rhythm Menu display, and each Element in the Voice Edit display.

To open the parameter list:

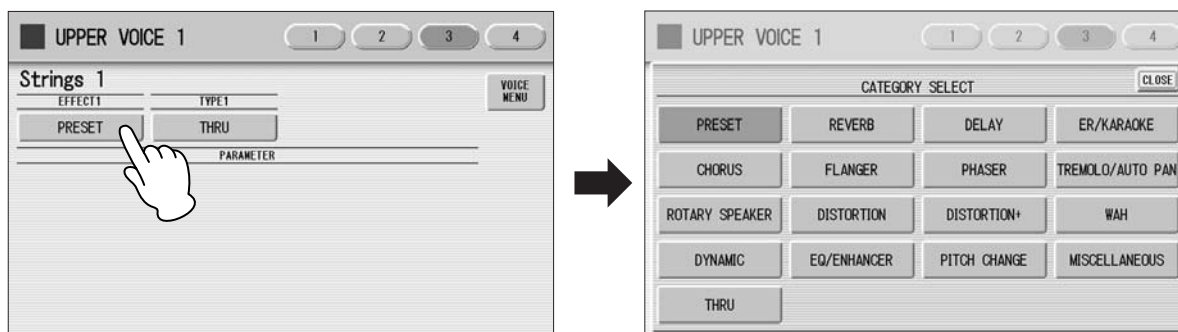

When you press the button, a parameter list will appear in which you can select the desired parameter. When you select items in the display, the list closes automatically. You can also close the list by pressing the [CLOSE] button at the top right of the list.

To change the parameter value:

To make coarse changes to the value, press the [▲]/[▼] buttons. For fine adjustment, use the Data Control dial.

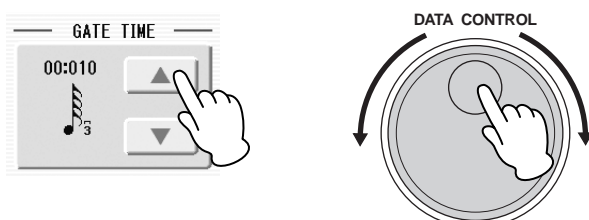

Adjusting Parameter Values by Using the Display Sliders

You can adjust some parameters such as Volume, Reverb, Pan and so on, by using the 'virtual' sliders in the display. There are two ways to move the slider in the display: touching it directly, and using the Data Control dial. We suggest that you touch the display slider when making coarse adjustments and use the Data Control dial for fine adjustment.

Touching the display slider directly:

Press a point in the slider to which you want to adjust the parameter value. The slider will move to the point you pressed. Also, by sliding your finger up or down while holding down the display slider, you can change the parameter value.

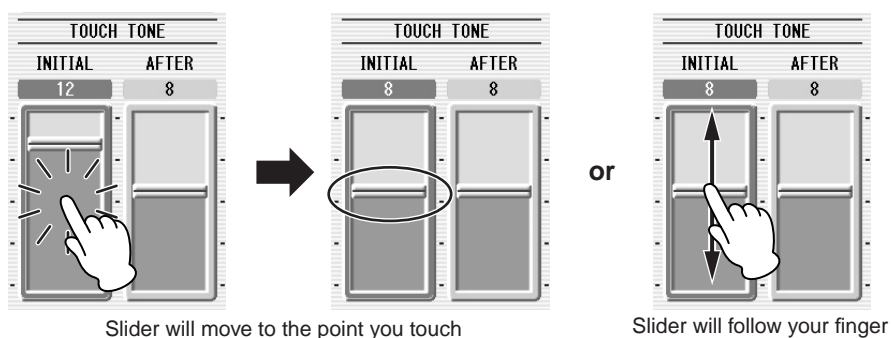

Using the Data Control dial:

Touch on/above the slider in the display to enable the parameter and set a rough value, then turn the Data Control dial.

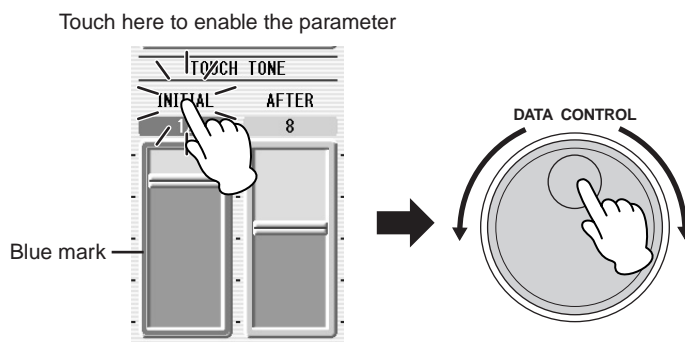

To control Pan, you can move the horizontal slider in the same way as vertical sliders.

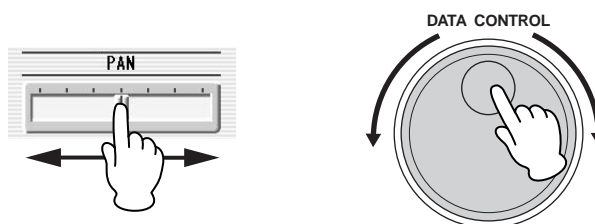

3 LCD Display Settings

Here you can change the display settings: displayed language (English or Japanese), touch panel sound, and display brightness.

Selecting the Display Language

The LCD display can be shown in two languages, English and Japanese. The default setting is English.

- 1 Press the [UTILITY] button to call up the GLOBAL Page of the Utility Display.



NOTE

The settings in the Utility Display are automatically saved when another display is called up.

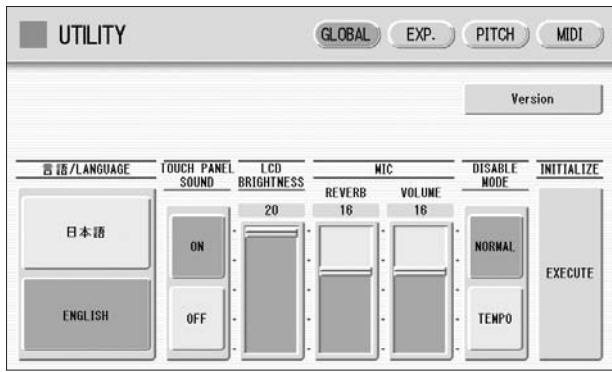
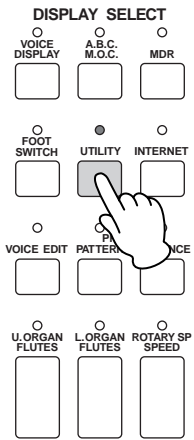

- 2 Press the desired button, 日本語 (Japanese) or [English].

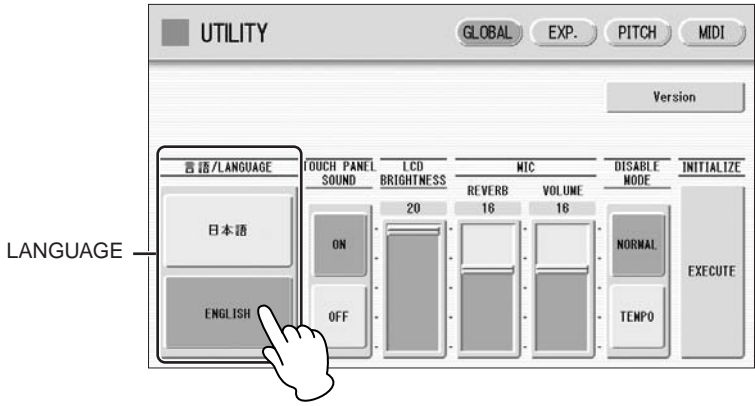

Muting the Touch Panel Sound

The Electone is set by default with the touch panel sound turned on, giving you audio feedback when you press a button or control. If you want to mute the touch panel sound, follow the procedure below.

- 1 Press [UTILITY] button to call up GLOBAL Page of the Utility Display.
- 2 Press the [OFF] button of the TOUCH PANEL SOUND to mute the sound.

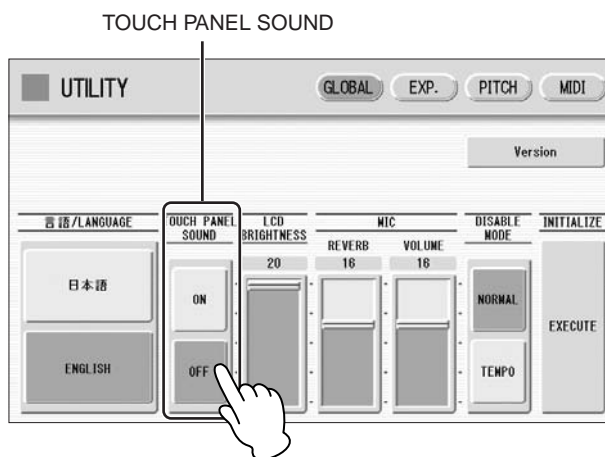

To turn the sound on again, select [ON] in Step 2.

Adjusting the Display Brightness

You can adjust the display brightness to a comfortable, easy-to-read level.

- 1 Press the [UTILITY] button to call up the GLOBAL Page of the Utility Display.
- 2 Move the LCD BRIGHTNESS slider by touching it directly or using the Data Control dial. Higher settings make the display brighter and lower settings make it darker.

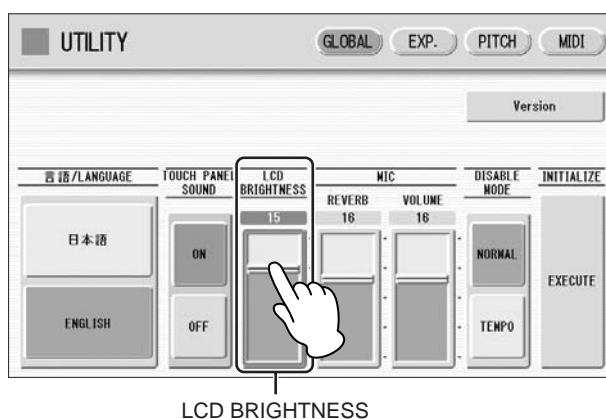

4 Voice Display

You can visually confirm the currently assigned Voices to each keyboard, currently selected rhythm, Registration Shift, and so on, in the Voice Display.

How to call up the Voice Display:

The Voice Display always appears when the Electone is turned on. To call up the Voice Display from any other display, press the [VOICE DISPLAY] button.

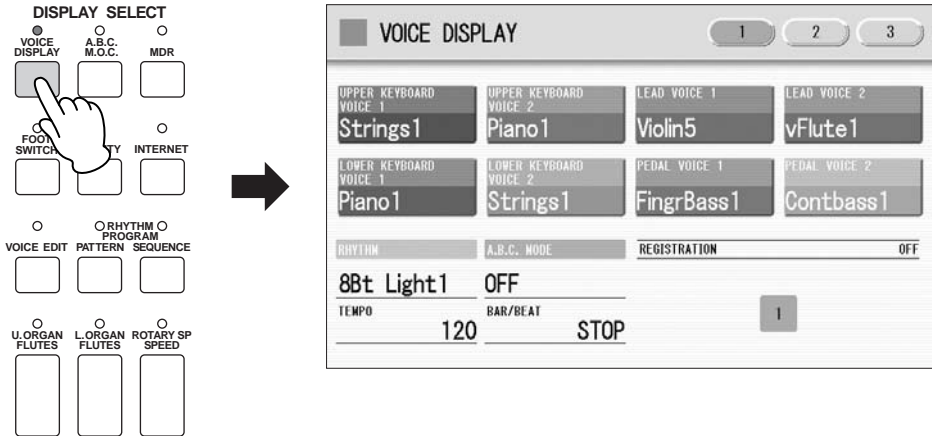

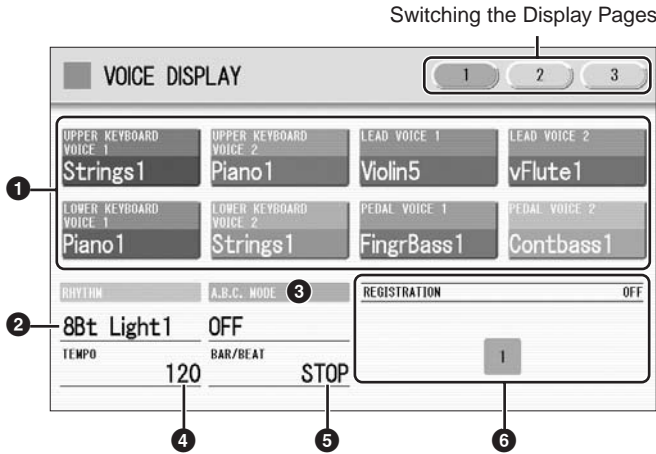

The Voice Display consists of three different pages that can be switched by pressing the [1], [2], or [3] button at the top right of the display.

Voice Display [Page 1]



 **Reference Page**
 Selecting a Voice (page 23)

 **Reference Page**
 Selecting a rhythm (page 51)

 **Reference Page**
 Auto Bass Chord (page 62)

 **Reference Page**
 Adjusting the tempo
 (page 56)

 **Reference Page**
 Registration Shift (page 85)

1 Voice Sections

Shows the Voices currently assigned to each Voice section. You can also mute specific Voice section by pressing its button (the button is grayed-out).

2 RHYTHM

Shows the currently selected rhythm.

3 A.B.C. MODE

Shows the mode of the Auto Bass Chord.

4 TEMPO

Shows the current rhythm tempo.

5 BAR/BEAT

Shows the bar/beat when the rhythm is playing.

6 REGISTRATION

Shows the current position of the Registration Shift.

Voice Display [Page 2]

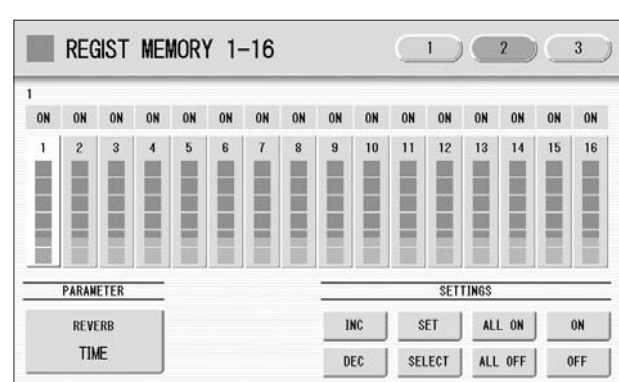

You can confirm the parameter values (for example, Reverb, Volume, Pan) for each Registration Memory simultaneously. Moreover, you can unify a specific parameter used in various Registration Memories at one time. See page 90 for the details.

Voice Display [Page 3]

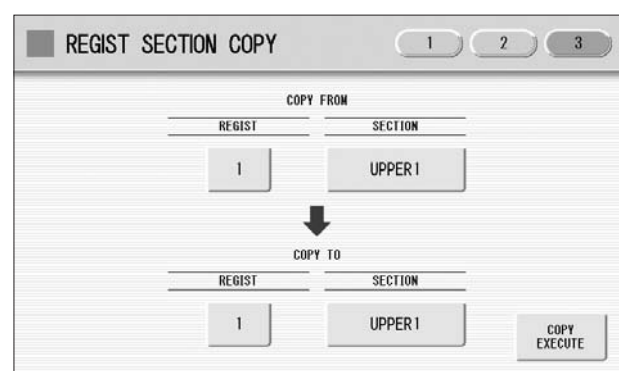

 **Reference Page**
 Registration Memory (page 80)

The Registrations stored to the Registration number can be copied to another Registration number for each individual section.

5 Registration Menu

A “Registration” consists of panel settings including the selected Upper Keyboard Voices, Lower Keyboard Voices, Pedal Voices, rhythm and so on. Each Registration Menu button (1 – 5) includes 48 Registrations (or 60 Registrations on the ELS-01C), each specially suited for playing in a different music style.



NOTE
Additional basic Registrations are preset on the Registration Memory locations from 1 to 16. See page 80 for details.

Selecting Registrations from the Registration Menu

1 Press one of the REGISTRATION MENU buttons.
Each button has different Registrations for different music genres. For example, if you want to play Jazz, press the [4] button. For details on the Registration Menu, see page 20.

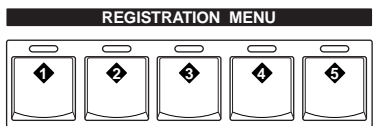

1	Kids
2	Pops & Rock
3	Dance & Ballad
4	Jazz & Latin
5	Symphony & World

2 Select the desired Registration by pressing the appropriate button on the display.
One display page contains 12 Registration buttons. Pressing the numbered buttons in the display changes the display pages, letting you select up to 48 Registrations from one Registration Menu button (or 60 Registrations, on the ELS-01C).

Change the display pages here.

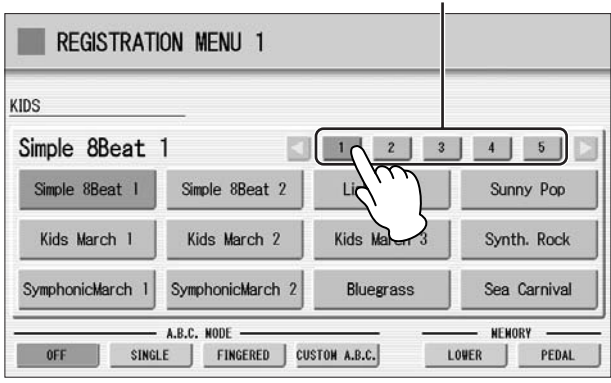

The color of the selected Registration name changes to orange, indicating that it has been selected, and the Auto Bass Chord mode is shown at the bottom of the display.

Reference Page
Auto Bass Chord (page 62)

3 Play your favorite song with the selected Registration.

Registration Menu List

Page	REGISTRATION MENU 1 KIDS	REGISTRATION MENU 2 POPS & ROCK	REGISTRATION MENU 3 DANCE & BALLAD	REGISTRATION MENU 4 JAZZ & LATIN	REGISTRATION MENU 5 SYMPHONY & WORLD	
1	Simple 8 Beat 1	Dynamic 8 Beat	Organ Ballad	Blow On Sax	Fanfare	
	Simple 8 Beat 2	NY Ballad	Dramatic Ballad	Sax Ensemble	String Orchestra	
	Light Step	British Pop	Love Ballad	Moonlight	Romantic Violin	
	Sunny Pop	8 Beat Modern	Smooth Lead	Big Band	Baroque	
	Kids March 1	Rock Band	Pop Ballad	Clarinet Swing	Flute&Harp	
	Kids March 2	Detroit Pop	Guitar Ballad	Jazz Combo	Serenade	
	Kids March 3	Techno Pop	Acoustic Ballad	Medium Jazz	Fast March	
	Synth. Rock	Sheriff Reggae	Healing Guitar	Organ Session	Wild West	
	Symphonic March 1	Rock&Roll	Chillout	Guitar Combo	Vienna Waltz	
	Symphonic March 2	Power Rock	Sweetheart 1	Tender Ballad	Polka	
	Bluegrass	60's Guitar Rock	Sweetheart 2	Jazz Waltz	Chanson Club	
Sea Carnival	Unplugged	Slow & Easy	Five-Four	Theatre Organ		
2	Basic Waltz	Motor City	Euro Trance	Big Band Samba	Flamenco	
	Brass Ensemble	Lovely Shuffle	6/8 Trance	Mambo Brass	Pop Flamenco	
	Pure Waltz	Gospel Shuffle	Cool Hip Hop	Mambo Tenor	Mexican Dance	
	Rococo Ensemble	Joyful Gospel	Latin House	Montuno	Mariachi	
	Pop Cha Cha	Frankly Soul	Dance Beat	Bossa Nova	Celtic Dance	
	Comical Rumba	Soul	Euro Dance Pop	Pop Bossa	Folk Step	
	Comical Samba	Gospel	UK Pop	Sweet Rumba	Italiano	
	Toy Orchestra	6/8 Soul	Jive	Beguine	Musette	
	Charleston	Hit Pop	Disco Queen	Cha Cha Cha	Country	
	Winter Swing	New Country	Disco Soul	Mellow Groove	Hawaiian	
	Snow Waltz 1	Eternal Pop	Pop Disco	Modern R&B	Chinese Nocturne	
	Snow Waltz 2	Ground Beat	Hot Disco	Dixieland Jazz	Japanese Sound	
	3	Alpine Polka *A	Bounce Pop *A	Ibiza *A	Jungle Drum *A	Orchestra March*A
Alpine Polka *B		Bounce Pop *B	Ibiza *B	Jungle Drum *B	Orchestra March*B	
Alpine Polka *C		Bounce Pop *C	Ibiza *C	Jungle Drum *C	Orchestra March*C	
Alpine Polka *D		Bounce Pop *D	Ibiza *D	Jungle Drum *D	Orchestra March*D	
Dream Ballad *A		Blues Jam *A	Power House *A	Jazz Club *A	Pasodoble *A	
Dream Ballad *B		Blues Jam *B	Power House *B	Jazz Club *B	Pasodoble *B	
Dream Ballad *C		Blues Jam *C	Power House *C	Jazz Club *C	Pasodoble *C	
Dream Ballad *D		Blues Jam *D	Power House *D	Jazz Club *D	Pasodoble *D	
Pops Orchestra*A		Evergreen Waltz*A	Dance Latino *A	Afro Session *A	Tango *A	
Pops Orchestra*B		Evergreen Waltz*B	Dance Latino *B	Afro Session *B	Tango *B	
Pops Orchestra*C		Evergreen Waltz*C	Dance Latino *C	Afro Session *C	Tango *C	
Pops Orchestra*D		Evergreen Waltz*D	Dance Latino *D	Afro Session *D	Tango *D	
4		Kids On Stage *A	16 Beat Pop *A	Twilight Disco*A	ChaCha Grandee*A	Show Time *A
		Kids On Stage *B	16 Beat Pop *B	Twilight Disco*B	ChaCha Grandee*B	Show Time *B
	Kids On Stage *C	16 Beat Pop *C	Twilight Disco*C	ChaCha Grandee*C	Show Time *C	
	Kids On Stage *D	16 Beat Pop *D	Twilight Disco*D	ChaCha Grandee*D	Show Time *D	
	Galaxy March *A	Top Gear Rock *A	Love Song *A	3/4 Fast Jazz *A	Majestic Sound*A	
	Galaxy March *B	Top Gear Rock *B	Love Song *B	3/4 Fast Jazz *B	Majestic Sound*B	
	Galaxy March *C	Top Gear Rock *C	Love Song *C	3/4 Fast Jazz *C	Majestic Sound*C	
	Galaxy March *D	Top Gear Rock *D	Love Song *D	3/4 Fast Jazz *D	Majestic Sound*D	
	SE *A	Southern Pop *A	Movie Ballad *A	Twilight Sax *A	Orchestra Swing*A	
	SE *B	Southern Pop *B	Movie Ballad *B	Twilight Sax *B	Orchestra Swing*B	
	SE *C	Southern Pop *C	Movie Ballad *C	Twilight Sax *C	Orchestra Swing*C	
	SE *D	Southern Pop *D	Movie Ballad *D	Twilight Sax *D	Orchestra Swing*D	
	5 (ELS-01C)	Bright 16 Beat *A	Funk *A	Hip Hop Pop *A	Organ Bossa *A	Orchestra 3001*A
		Bright 16 Beat *B	Funk *B	Hip Hop Pop *B	Organ Bossa *B	Orchestra 3001*B
Bright 16 Beat *C		Funk *C	Hip Hop Pop *C	Organ Bossa *C	Orchestra 3001*C	
Bright 16 Beat *D		Funk *D	Hip Hop Pop *D	Organ Bossa *D	Orchestra 3001*D	
Movie Panther *A		West Coast Rock*A	Fusion Shuffle*A	Afro Cuban *A	Wedding Song *A	
Movie Panther *B		West Coast Rock*B	Fusion Shuffle*B	Afro Cuban *B	Wedding Song *B	
Movie Panther *C		West Coast Rock*C	Fusion Shuffle*C	Afro Cuban *C	Wedding Song *C	
Movie Panther *D		West Coast Rock*D	Fusion Shuffle*D	Afro Cuban *D	Wedding Song *D	
Powerful Swing*A		6/8 Enka *A	Whole Ballad *A	Midnight Jazz *A	Fantasy *A	
Powerful Swing*B		6/8 Enka *B	Whole Ballad *B	Midnight Jazz *B	Fantasy *B	
Powerful Swing*C		6/8 Enka *C	Whole Ballad *C	Midnight Jazz *C	Fantasy *C	
Powerful Swing*D		6/8 Enka *D	Whole Ballad *D	Midnight Jazz *D	Fantasy *D	

6 Confirming the Version of Your Electone

You can confirm the version of your Electone by the following procedure.

- 1 **Press the [UTILITY] button.**
The Utility display appears.
- 2 **Press the [GLOBAL] button at the top right of the display, then press the [Version] button in the display.**
The Version dialog appears in the display. Pressing [OK] closes the dialog.

7 Factory Set (Initializing the Electone)

All current settings including Registration Memory, User Voices, User Rhythms, and LCD Display settings can be deleted at once by the following procedure. Be careful when executing Factory Set, since it erases all your existing data. Always save your important data to external media, such as a USB flash memory.
Factory Set does not reset the Internet Direct Connection settings. If you want to reset the Internet Direct Connection settings, see page 206.

 **Reference Page**
Saving Registrations
(page 111)

 **Reference Page**
Initializing Internet Settings
(page 206)

- 1 **Turn off the power.**
- 2 **While holding down the ENDING [1] button, turn the power back on.**

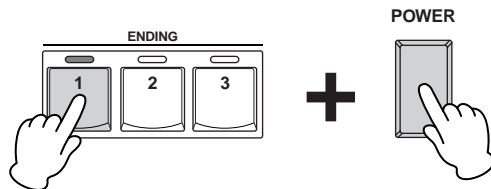

- 3 **Release the ENDING [1] button after Voice Display appears.**
If you don't want to reset the LCD Display settings, you can initialize only Registration settings. See page 85 for more information.

 **Reference Page**
Initializing Registration
Memory (page 85)

This Electone features hundreds of high quality Voices. Any of these Voices can be used on the Upper Keyboard, Lower Keyboard and Pedalboard. Up to four Voice sections are available on the Upper Keyboard for playing together in a layer, while the Lower Keyboard and Pedalboard each have two Voice sections.

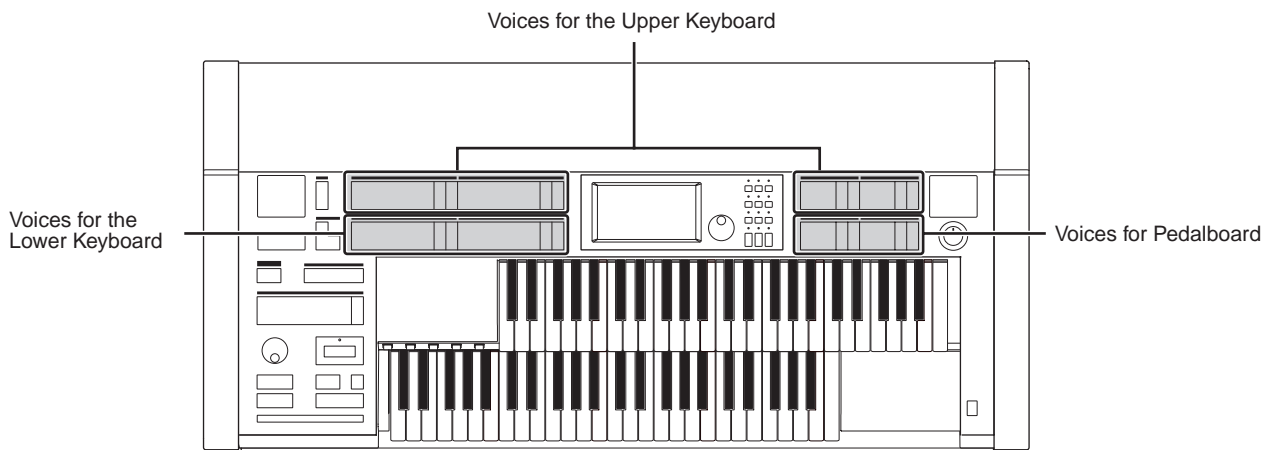

Contents

1 Voices for each keyboard	22	3 Selecting Voices from the User buttons	28
2 Selecting Voices with the Voice buttons	23	4 Voice List	30
• Selecting a Voice	23		
• Changing the Voice volume	25		

1 Voices for each keyboard

Voices for the Upper Keyboard

Up to four different Voice sections are available on the Upper Keyboard for playing together: Upper Keyboard Voice 1, Upper Keyboard Voice 2, Lead Voice 1, and Lead Voice 2. Voices for each section can be selected from the panel.

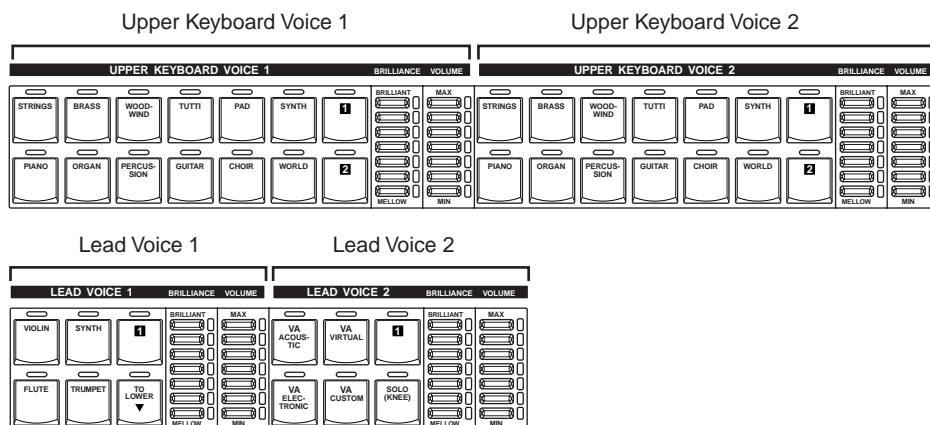

Reference Page

AWM Voices and VA Voices (page 34)

Lead Voice 1 and 2 sound only the highest note (or last note played) if two or more keys are played together. This makes the Lead Voices ideal for “lead” or solo instruments such as Trumpet and Saxophone. Lead Voice 2 includes additional, exclusive VA Voices which are not available in other Voice sections.

Voices for the Lower Keyboard

Up to two different Voice sections are available on the Lower Keyboard for playing together: Lower Keyboard Voice 1 and Lower Keyboard Voice 2. Voices for each section can be selected from the panel.

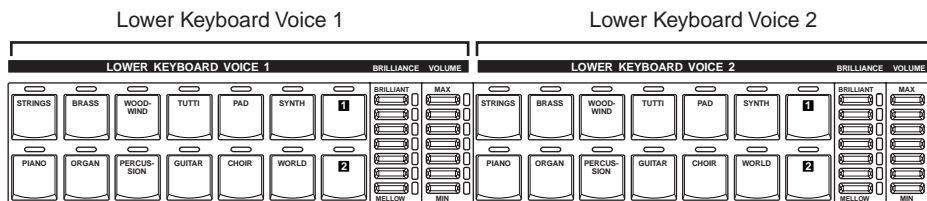

Voices for Pedalboard

Up to two different Voice sections are available on the Pedalboard for playing together: Pedal Voice 1 and Pedal Voice 2. Voices for each section can be selected from the panel. Pedal Voices 1 and 2 sound only the highest note if two or more pedals are played, by default.



Reference Page

POLY (page 40)

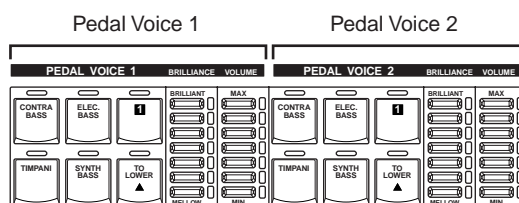

2 Selecting Voices with the Voice buttons

Since selection of Voices follows the same procedure throughout all Voice sections, instructions for only the Upper Keyboard Voice 1 are given here.

Selecting a Voice

- 1 Press one of the Voice buttons in the Upper Keyboard Voice 1 section.

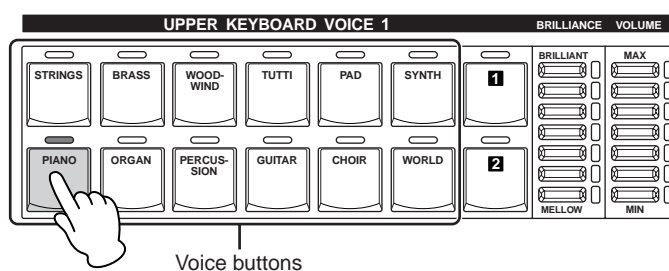

For example, if you have pressed the [PIANO] button, the following display (Voice Menu) will appear.

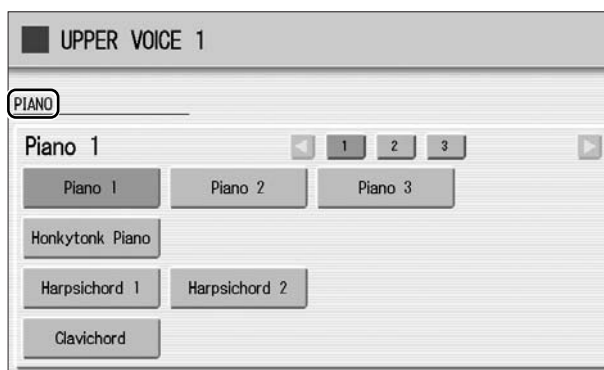

2 Select the desired Voice name from the Voice menu.

The Voice menu contains many Piano Voices, more than can fit on one display page. To change the display pages, press the appropriate number buttons in the display.

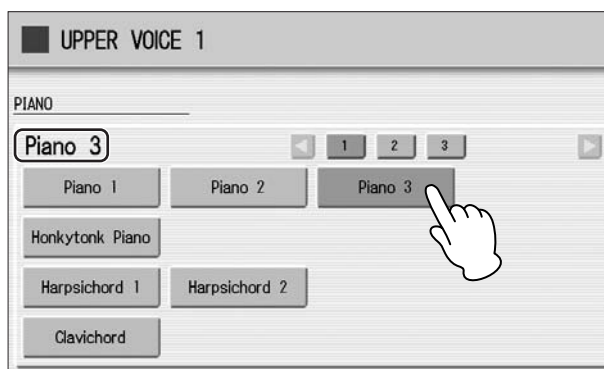

The color of the selected Voice name changes to orange, indicating that it has been selected.

Changing the Voice volume

There are two ways to set the Voice volume: using the VOLUME buttons on the panel and using the volume slider in the display. The VOLUME buttons let you make coarse adjustments to the volume while the slider gives you fine control.

Using the VOLUME buttons on the panel (coarse)

Press one of the VOLUME buttons of each Voice section on the panel to set the desired level for each Voice.

The buttons have seven volume settings, from a minimum of 0, or no sound, to a maximum of full volume.

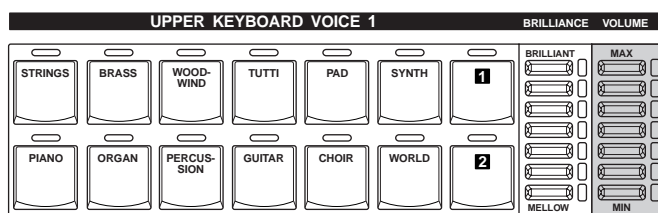

Using VOLUME slider in the display (fine)

Pressing the same Voice button on the panel again (or pressing the Voice name of the selected Voice in the display) calls up the Voice Condition Display.

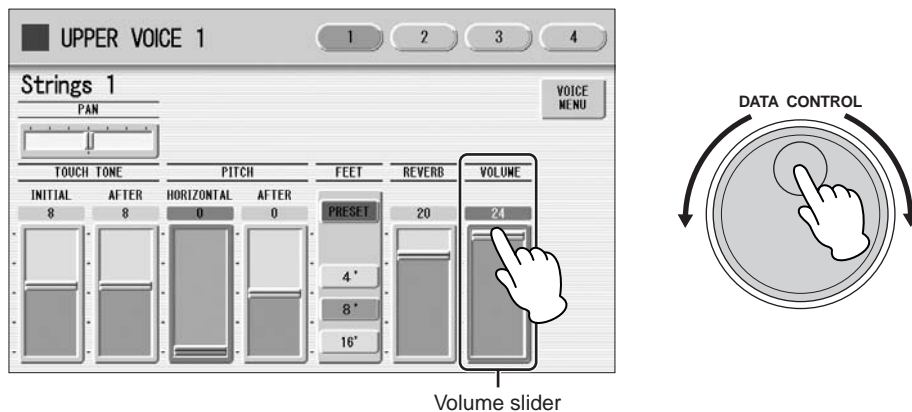

Volume slider

To set the volume, touch the VOLUME slider in the display or use the Data Control Dial. The control range is from 0 (no sound) to 24 (full volume).



NOTE

Depending on the volume value (set by the slider), two adjacent VOLUME button lamps may be lit at the same time, indicating an intermediate position.

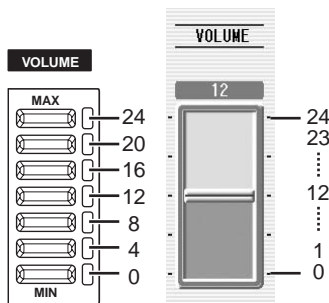

Pressing a Voice button once calls up the Voice Menu display for the selected button. Pressing it a second time calls up the Voice Condition display. Successive presses alternate between the two displays.

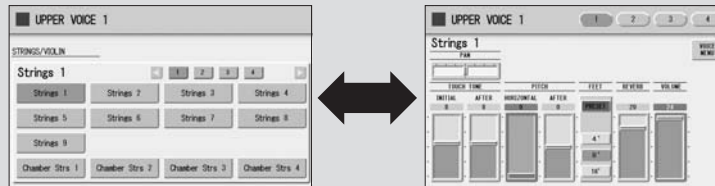
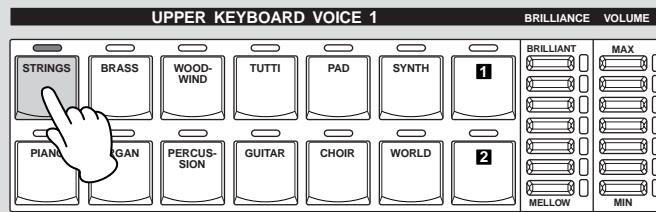

When the Voice Condition display is shown, pressing [VOICE MENU] button on the display also calls up the Voice Menu.

From the Voice Condition display, you can control Voice-related parameters such as Pan, Effect, Volume, and so on. For more information on the Voice Condition display, see page 39.



Turning the Electone off erases all panel settings you have made.

If you wish to keep the panel settings you have made, save them to a USB flash memory or other external media before turning the Electone off (page 84).

About the To Lower function

Voices selected for the Lead Voice 1, Pedal Voice 1, and Pedal Voice 2 sections can also be played on the Lower Keyboard when the [TO LOWER] button in each section is on. When [TO LOWER] is on, the Lead Voice and Pedal Voice cannot be played on the Upper Keyboard and Pedalboard, respectively.

The To Lower function is not available in the Lead Voice 2 section.

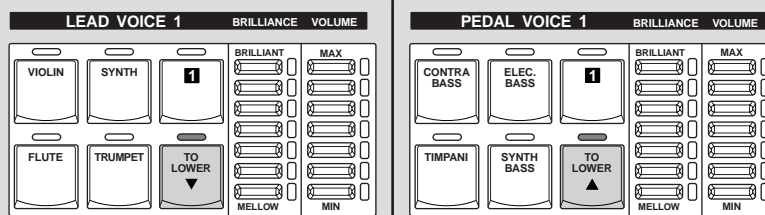

About the Solo function

The Lead Voice 2 section features an exclusive Solo function. Solo lets you instantly switch to a solo Lead Voice in the middle of your performance, muting all other Upper Keyboard Voices.

1 Select the Voice that you wish to play solo in the Lead Voice 2 section.

In this condition, all the Voices for Upper Keyboard (Upper Keyboard Voice 1 and 2, and Lead Voice 1 and 2) can be played.

2 Press the [SOLO (KNEE)] button in the Lead Voice 2 section.

This sets Solo to standby status.

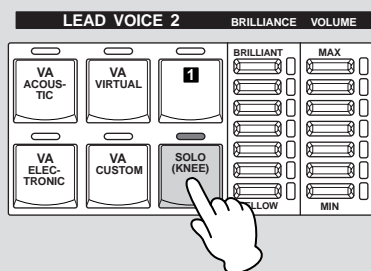

3 To use Solo, unfold the knee lever. (Bring it down into position.)

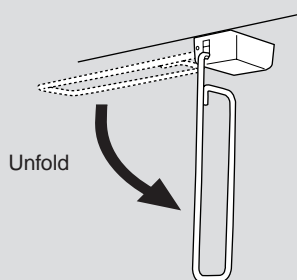

In this condition (Solo on), only the Lead Voice 2 is playable on the Upper Keyboard. (All other Voices are muted.)

4 To temporarily turn Solo off as you play, press the Knee Lever to the right with your knee.

In this condition, all Voices set to the Upper Keyboard except for Lead Voice 2 are playable on the Upper Keyboard. (Only Lead Voice 2 is muted.) Each time you press the Knee Lever (Solo off) you can play all Voices except Lead Voice 2, and each time you release it (Solo on) you can play only Lead Voice 2 on the Upper Keyboard.

Notes on using Solo

- The knee lever can be used to control other functions, such as switching Sustain. When other functions are assigned to the knee lever, pressing knee lever turns these functions on at the same time.
- Pressing the knee lever while holding down a key will not turn Solo off for that key. Solo remains active until the next key is played after pressing the knee lever.
- Lead Voices 1 and 2 sound only the highest note if two or more keys are played. However, in the Solo mode, Lead Voice 2 sounds for the last key played.



Reference Page

Knee Lever (page 188)



Reference Page

Voice Condition Display (page 39)

3 Selecting Voices from the User buttons

This Electone has a wide variety of Voices from which you can choose – far greater than what is immediately apparent from the Voice buttons on the panel. Each Voice section has one or two User buttons (numbered 1 or 2) which can be found at the right side of each Voice section. You can use the User buttons to select Voices that cannot be selected normally from the Voice buttons – such as Contrabass for the Upper Keyboard Voice.

1 Press one of the User buttons in any of the Voice sections.

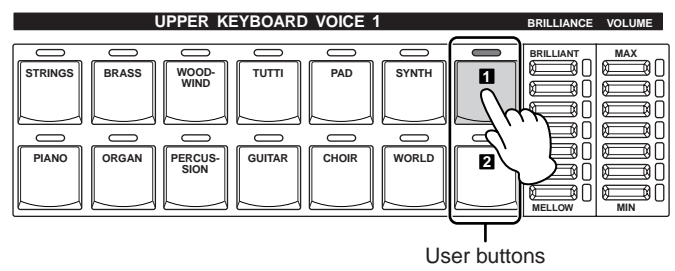

Reference Page
Voice Edit (page 131)

2 Select the desired instrument category with the category buttons in the display. You can also choose the “USER” category to select a User Voice you have created.

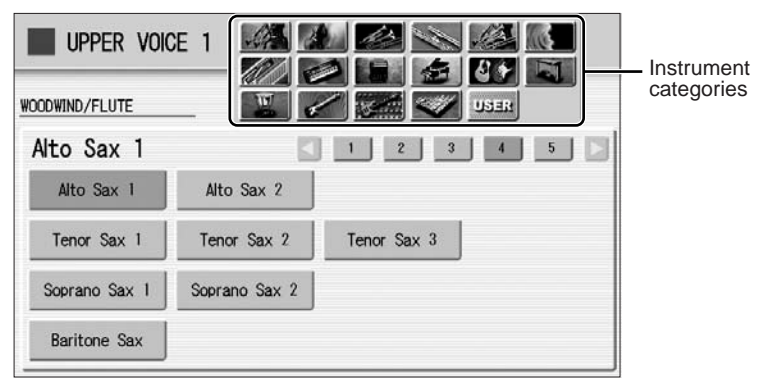

Reference Page
Voice List (page 30)

For example, to call up Marimba 1, select the percussion category.

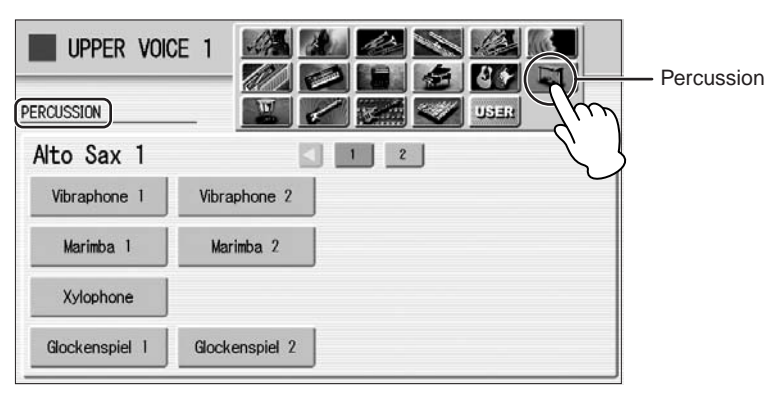

The name of the selected category (Percussion) is displayed on the upper left. The Voice name shown under the category name is that of the currently assigned Voice and is irrelevant to the Voice menu below.

To directly select the desired category, hold down one of the User buttons and simultaneously press the desired Voice button.

1. While holding down the User button...

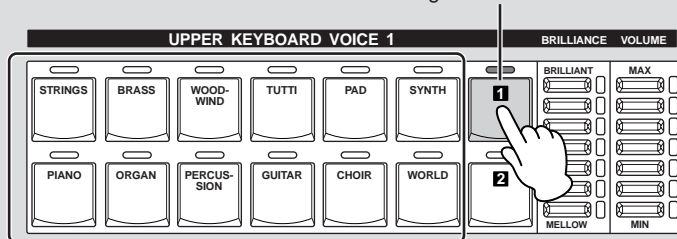

2. Press the Voice button.

3 Select a Voice (Marimba 1, for example) from the displayed Voice Menu.

Pressing number buttons in the display calls up the other Voices in the category,



The Voice name of the selected Voice (Marimba 1) appears under the category name, indicating that the Voice has been selected.

4 Voice List

This list shows all available Voices on the Electone. Numbers written at the left side of each column in this list indicate the numbered buttons displayed in the Voice Menu.

ELS-01/01C

STRINGS/VIOLIN	
	Strings 1
	Strings 2
	Strings 3
	Strings 4
	Strings 5
	Strings 6
1	Strings 7
	Strings 8
	Strings 9
	Chamber Strs 1
	Chamber Strs 2
	Chamber Strs 3
	Chamber Strs 4
	Pizzicato Strs 1
	Pizzicato Strs 2
2	Pizzicato Strs 3
	Pizzicato Strs 4
	Tremolo Strings
	Strings1&7
	Strings2&Viola
	Strings3&4
3	Strings7&Violin5
	Violin5&Cello
	Octave Strings 1
	Octave Strings 2
	Violin 1
	Violin 2
	Violin 3
	Violin 4
	Violin 5
	Violin 6
	Viola
	Cello 1
	Cello 2
	Pizzicato Violin
CONTRABASS	
	Contrabass 1
	Contrabass 2
	Contrabass 3
	Contrabass 4
1	Contrabass 5
	Acoustic Bass 1
	Acoustic Bass 2
	Pizzicato Bass 1
	Pizzicato Bass 2
BRASS/TRUMPET	
	Brass Section 1
	Brass Section 2
	Brass Section 3
1	Brass Section 4
	Brass Section 5
	Brass Section 6

	Trombone Sec 1
	Trombone Sec 2
1	Trombone Sec 3
	Trombone Sec 4
	Trombone Sec 5
	Brass1&Trp6
	Brass2&Trp6
	Horn 1&4
	Octave Brass 1
	Octave Brass 2
2	Octave Brass 3
	Octave Brass 4
	Octave Brass 5
	Octave Brass 6
	Octave Brass 7
	Trumpet 1
	Trumpet 2
	Trumpet 3
	Trumpet 4
	Trumpet 5
	Trumpet 6
3	Trumpet 7
	Muted Trumpet 1
	Muted Trumpet 2
	Muted Trumpet 3
	Flugel Horn 1
	Flugel Horn 2
	Trombone 1
	Trombone 2
	Trombone 3
4	Trombone 4
	Muted Trombone 1
	Muted Trombone 2
	Horn 1
	Horn 2
	Horn 3
	Horn 4
	Horn 5
	Horn 6
	Muted Horn
	Tuba 1
	Tuba 2
	Euphonium
6	Brass Bass 1
	Brass Bass 2
	Brass Bass 3
WOODWIND/FLUTE	
	Flute 1
	Flute 2
1	Flute 3
	Flute 4
	Piccolo
	Recorder 1

	Recorder 2
1	Ocarina
	Whistle
	Clarinet 1
	Clarinet 2
2	Clarinet 3
	Clarinet 4
	Bass Clarinet
	Oboe 1
	Oboe 2
	Oboe 3
	Oboe 4
	Oboe 5
3	English Horn 1
	English Horn 2
	Bassoon 1
	Bassoon 2
	Bassoon 3
	Alto Sax 1
	Alto Sax 2
	Tenor Sax 1
	Tenor Sax 2
4	Tenor Sax 3
	Soprano Sax 1
	Soprano Sax 2
	Baritone Sax
	Sax Ens 1
	Sax Ens 2
	Sax Ens 3
5	Woodwind Ens 1
	Woodwind Ens 2
	Woodwind Ens 3
	Woodwind Ens 4
TUTTI	
	Strings&Winds
	Strings&Brass 1
	Strings&Brass 2
1	Strings&Horn
	Brass&Sax 1
	Brass&Sax 2
	Brass&Sax 3
	Brass&Winds
2	Orchestra Hit
CHOIR	
	Choir 1
	Choir 2
	Choir 3
	Choir 4
1	Choir 5
	Choir 6
	Choir 7
	Choir 8
	Choir 9

2	Vocal
PAD	
	Smooth Pad 1
	Smooth Pad 2
	Smooth Pad 3
	Smooth Pad 4
1	Smooth Pad 5
	Smooth Pad 6
	Smooth Pad 7
	Smooth Pad 8
	Resonance Pad 1
	Resonance Pad 2
	Resonance Pad 3
	Resonance Pad 4
	Resonance Pad 5
2	Resonance Pad 6
	Resonance Pad 7
	Resonance Pad 8
	Resonance Pad 9
	Resonance Pad 10
	Resonance Pad 11
	Bell Pad 1
	Bell Pad 2
	Bell Pad 3
	Bell Pad 4
3	Bell Pad 5
	Bell Pad 6
	Bell Pad 7
	Bell Pad 8
	Bell Pad 9
	Space Pad 1
	Space Pad 2
	Space Pad 3
4	Space Pad 4
	Space Pad 5
	Space Pad 6
	Noisy Pad 1
	Noisy Pad 2
5	Noisy Pad 3
	Noisy Pad 4
	Noisy Pad 5
SYNTH	
	Synth Lead 1
	Synth Lead 2
	Synth Lead 3
1	Synth Lead 4
	Synth Lead 5
	Synth Lead 6
	Synth Lead 7
	Synth Lead 8
	Pop Lead 1
2	Pop Lead 2
	Pop Lead 3

2	Pop Lead 4
	Pop Lead 5
	Pop Lead 6
	Pop Lead 7
3	Synth Cla 1
	Synth Cla 2
	Synth Cla 3
	Synth Cla 4
	Synth Cla 5
	Synth Cla 6
	Synth Sax
	Synth Trumpet
Synth Violin	
4	Synth Brass 1
	Synth Brass 2
	Synth Brass 3
	Synth Brass 4
	Synth Brass 5
	Synth Brass 6
	Synth Brass 7
	Synth Brass 8
	Synth Brass 9
	Synth Brass 10
	Synth Brass 11
	Synth Brass 12
	Synth Brass 13
5	Synth Strs 1
	Synth Strs 2
	Synth Strs 3
	Synth Strs 4
	Synth Strs 5
	Synth Strs 6
	Synth Strs 7
6	Synth Bell 1
	Synth Bell 2
	Synth Bell 3
	Synth Bell 4
	Synth Bell 5
	Synth Bell 6
	Synth Bell 7
	Synth Decay 1
	Synth Decay 2
	Synth Decay 3
	Synth Decay 4
ORGAN	
1	Pipe Organ 1
	Pipe Organ 2
	Pipe Organ 3
	Pipe Organ 4
	Pipe Organ 5
	Harmonica 1
Harmonica 2	
Harmonica 3	
2	Theatre Organ 1
	Theatre Organ 2
	Theatre Organ 3
	Theatre Organ 4
	Theatre Organ 5
	Theatre Organ 6
	Theatre Organ 7

2	Theatre Organ 8
	Accordion 1
	Accordion 2
	Accordion 3
	Accordion 4
	Bandoneon
	Reed Organ
	Jazz Organ 1
	Jazz Organ 2
Jazz Organ 3	
3	Jazz Organ 4
	Jazz Organ 5
	Jazz Organ 6
	Jazz Organ 7
	Jazz Organ 8
	Jazz Organ 9
	Pop Organ 1
4	Pop Organ 2
	Pop Organ 3
	Pop Organ 4
	Pop Organ 5
	Rock Organ 1
	Rock Organ 2
	Rock Organ 3
5	Organ Bass 1
	Organ Bass 2
	Organ Bass 3
	Organ Bass 4
PIANO	
1	Piano 1
	Piano 2
	Piano 3
	Honkytonk Piano
	Harpsichord 1
	Harpsichord 2
Clavichord	
2	DX E.Piano 1
	DX E.Piano 2
	DX E.Piano 3
	DX E.Piano 4
	Stage E.Piano 1
	Stage E.Piano 2
	Stage E.Piano 3
	Stage E.Piano 4
	Stage E.Piano 5
	Stage E.Piano 6
3	Stack E.Piano 1
	Stack E.Piano 2
	Clavi 1
	Clavi 2
GUITAR	
1	Nylon Guitar 1
	Nylon Guitar 2
	Steel Guitar 1
	Steel Guitar 2
	12Str Guitar
	Jazz Guitar 1
	Jazz Guitar 2
	Harp 1
Harp 2	

1	Harp 3
	Elec Guitar 1
	Elec Guitar 2
2	Elec Guitar 3
	Elec Guitar 4
	Elec Guitar 5
	Muted Guitar
	Distortion Gtr 1
	Distortion Gtr 2
	Distortion Gtr 3
3	Banjo
	Mandolin
	Pedal Steel Gtr
PERCUSSION	
1	Vibraphone 1
	Vibraphone 2
	Marimba 1
	Marimba 2
	Xylophone
	Glockenspiel 1
Glockenspiel 2	
2	Celesta 1
	Celesta 2
	Music Box 1
	Music Box 2
	Chime 1
	Chime 2
Chime 3	
TIMPANI	
1	Timpani 1
	Timpani 2
	Timpani Roll 1
	Timpani Roll 2
	Timpani Roll 3
ELECTRIC BASS	
1	Fingered Bass 1
	Fingered Bass 2
	Fingered Bass 3
	Fingered Bass 4
	Fingered Bass 5
	Slap Bass 1
	Slap Bass 2
	Slap Bass 3
	Slap Bass 4
	2
Picked Bass 2	
Picked Bass 3	
Picked Bass 4	
Fretless Bass 1	
Fretless Bass 2	
SYNTH BASS	
1	Funk Bass 1
	Funk Bass 2
	Funk Bass 3
	Funk Bass 4
	Funk Bass 5
	Funk Bass 6
	Funk Bass 7
	Funk Bass 8
	Funk Bass 9

2	Funk Bass 10
	Dance Bass 1
	Dance Bass 2
	Dance Bass 3
	Dance Bass 4
	Dance Bass 5
	Dance Bass 6
	Dance Bass 7
3	Dance Bass 8
	Smooth Bass 1
	Smooth Bass 2
	Smooth Bass 3
	Smooth Bass 4
	Smooth Bass 5
	Smooth Bass 6
Smooth Bass 7	
WORLD	
1	Pan Flute 1
	Pan Flute 2
	Bagpipe
	Dulcimer
	Shakuhachi
	Yokobue
2	Shamisen
	Koto
	Taishokoto
	Erhu 1
	Erhu 2
	Sheng
3	Zheng
	Pipa
	Nay
	Surnay
	Oud
	Sitar
3	Kamanche
	Steel Drum
	Log Drum
	Kalimba

ELS-01C (VA)

	Voice Name	Range	Description
VA ACOUSTIC			
1	V-Flute 1	G2 – A6	Flute with breath and other noises, which may squeak in higher registers. Setting the Touch Tone (After) higher and applying keyboard pressure can recreate flutter tonguing.
	V-Flute 2	C2 – C6	Flute suited for legato playing. Setting the User Vibrato depth to higher values has a nice effect.
	V-Ocarina	C3 – C6	Soft ocarina.
	V-Oboe	C3 – F5	Wider dynamic range with the Touch Tone effect.
	V-Clarinet	D2 – F5	Playing pianissimo creates breath noises, while playing fortissimo creates a brighter sound with slightly lower pitch.
	V-Soprano Sax	A#2 – D5	Rounder and softer soprano saxophone.
	V-Alto Sax 1	D#2 – G4	A bright alto saxophone for contemporary music. You can make the sound 'break up' as if overblowing the instrument by setting After Touch to maximum and applying pressure to the key.
	V-Alto Sax 2	C2 – E4	Alto saxophone suited for fusion music. Playing legato creates squeaky attack sounds and high After Touch settings produce an overblowing effect.
	V-Tenor Sax 1	A#2 – C4	Multi-purpose tenor saxophone. Soft in pianissimo and brighter in fortissimo.
	V-Tenor Sax 2	C1 – G4	Soft tenor saxophone suited for jazz. Playing Legato creates squeaky attack sounds.
	V-Breath Sax 1	A#2 – C4	Soft, breathy tenor saxophone suited for slow tempo music.
	V-Breath Sax 2	C2 – E4	Brighter, breathy tenor saxophone suited for jazz.
2	V-Trumpet 1	A#2 – A#4	Soft trumpet. Slides and glissandos can be created with Horizontal Touch.
	V-Trumpet 2	C2 – C5	Trumpet with characteristic attack sound. Lip slurs can be created by changing the pitch.
	V-Trumpet 3	G2 – C5	Soft trumpet. Applying slight keyboard pressure produces breath noise.
	V-Muted Trumpet	A#2 – A#4	Cup-muted trumpet.
	V-Trombone	E1 – G3	Slides and glissandos can be created with Horizontal Touch. Also, high After Touch settings produce an overblowing effect.
	V-High Trombone	C2 – C5	Brighter trombone suited for high notes.
	V-Shakuhachi	---	Higher Touch Tone (After) setting increases breath noise and also squeaks the sound.
	V-Erhu	---	Playing with softer touch produces hoarse sounds.
	V-Sitar	---	Playing with harder touch squeaks the sounds.
VA VIRTUAL			
1	V-Pan Pipe 1	E2 – G5	Setting the Touch Tone (After) higher and applying keyboard pressure can result in flutter tonguing.
	V-Pan Pipe 2	C1 – C6	Panpipe flute sound. After and Initial Touch affect the pitch and timbre.
	V-Bamboo	C1 – C6	Bamboo panpipe sound with breath noise. After Touch changes the pitch dynamically.
	V-Bottle	C1 – C6	Sound of blowing a bottle. Playing trills over a wide interval range creates a squeaky attack sound.
	V-Floboe	F2 – C7	A hybrid sound combining oboe and saxophone.
	V-Alt Kwek	C3 – C7	A hybrid sound grafting an oboe reed onto a piccolo, with a distinctive pitch change in the low registers.
	V-Tin Whistle	C2 – C7	Sound of a small flute. Playing with softer touch produces breath noise.
	V-India	---	Percussive sitar sound.
	V-East	G1 – C5	Sitar with resonance and reverberation.
	V-Zag	---	Simulation of a bowed ethnic instrument. Playing legato brings out higher octave sounds.
2	V-Asian Pluck	C1 – G6	Plucked ethnic instrument. Using Initial Touch brings out higher octave sounds.
	V-Air Reed 1	A2 – C5	A hybrid sound grafting an oboe reed onto a saxophone. High After Touch settings produce an overblowing effect.
	V-Air Reed 2	E2 – C5	A hybrid sound combining a conventional flute with panpipes.
	V-Airphone	A2 – C5	A hybrid sound grafting an oboe reed onto a soprano saxophone.
	V-Thin Reed	E2 – G5	A hybrid sound grafting a clarinet mouthpiece onto a flute. High After Touch settings produce an overblowing effect.
	V-Harmophone	G1 – G5	A hybrid sound combining a harmonica and saxophone. Depending on use of Touch Tone, both breath noise and a bright clear sound can be produced.
	V-Saxonica	G2 – G5	Harmonica sound resembling an alto saxophone. Playing with soft touch results in a high-pitched sound.
	V-Grass Reed	E2 – G5	A hybrid sound grafting a bassoon reed onto a brass wind instrument. After Touch changes the pitch.
	V-Soft Reed 1	A2 – G5	A hybrid sound grafting a clarinet mouthpiece to a brass wind instrument.
	V-Soft Reed 2	C1 – C6	A hybrid sound grafting a bassoon reed onto a soprano saxophone; includes breath noise.
	V-Troppo	E1 – C6	Thick bassoon sound. After Touch changes the pitch dynamically, and applying keyboard pressure more produces wind noise.
3	V-Buzz String	A2 – F5	Simulation of a hybrid bowed-wind instrument.
	V-Bow String	E1 – E6	Artificial synthesized strings sound.
	V-String Bow	C1 – C6	Simulation of a slow-attacked violin bowed with something other than a violin bow. Playing trills over a wide interval range creates a squeaky attack sound.
	V-Cosmosis	C1 – G5	Bowed strings. Initial Touch affects the attack sound.

	Voice Name	Range	Description
3	V-E.Violin	C1 – C6	Synth violin.
	V-Bowe	C1 – C5	Simulation of a hybrid bowed-saxophone sound.
	V-Claviolin	G2 – G5	A hybrid sound combining a violin and wind instrument.
	V-Air Bow	C2 – G5	A bowed instrument sound with noise.
	V-Waspy Horn	C1 – G4	A hybrid sound grafting a brass wind instrument mouthpiece to a wind instrument. After Touch affects the muted condition. Lip-slide can be created with Horizontal Touch.
	V-Mizu Horn	C1 – C6	A hybrid sound combining a harmonica and trumpet.
	V-Cosmo Mute	C1 – C5	Simulation of a distorted brass wind instrument. After and Initial Touch affect the muted condition.
	V-Fago	F1 – C7	Simulated deep bassoon sound. Playing with soft touch produces breath noise with a high tone range.
VA ELECTRONIC			
1	V-Jazz Guitar	E1 – E5	Soft and warm jazz guitar sound.
	V-Picked Guitar	E1 – E5	Hard-attack guitar played with a pick.
	V-Simple Bass	---	Voice suited for bass phrases. After and Initial touch affect the resonance effect.*
	V-Bass Attack	---	Voice suited for bass phrases. Initial touch affects the muted condition.*
	V-Thumb Bass	C1 – E4	Bass sounds played with the thumb.*
	V-Fretless	C1 – C5	Fretless bass.*
	V-Saw Lead	C1 – C5	Multi-purpose lead sounds. After Touch affects the filter changes.
	V-Edge Lead	C1 – C4	Synth bass sound with a sharp attack portion. After Touch affects the filter changes.
	V-Dist Lead	G1 – C5	Distorted lead sounds. Setting the Touch Tone (After) higher and applying keyboard pressure raises the pitch.
	V-Woody Lead	C2 – G5	Lead sound with woody quality.
	V-Muted Lead	C2 – C5	Lead sound with wah-wah effect. After Touch heightens the wah-wah effect.
	V-Talken Lead	C1 – C5	Human voice-like lead sound. Setting the Touch Tone (After) higher and applying keyboard pressure allows creation of hum noise.
2	V-Mad Tube	---	Distorted synth lead with long release sound. High After Touch settings produce an overblowing effect.*
	V-Mob	---	Distorted lead sound played with pick. Setting the Touch Tone (After) higher and applying keyboard pressure raises the pitch by an octave.*
	V-Transylva	C1 – C6	Softly distorted lead sounds.*
	V-Destiny	---	Wah guitar with a sharp attack.
	V-Igneous	C1 – C4	Lead sound with full feedback effects. After Touch affects the degree of feedback.
	V-Wurli Lead	C1 – C5	Simple synth lead with a sharp attack. High After Touch settings produce an overblowing effect.
	V-Fifty Fifty	---	Analog synthesizer with simple square wave sound.
	V-Ana Wave	---	Analog synthesizer. Initial touch and the length of holding down a key changes the filter effect.
	V-Lyric Off	C1 – C6	Wind synth sound with square wave sound.
	V-Ossyncro	C1 – C6	Lead sound with dynamic pitch change.*
	V-Wahman	C1 – A3	Wah-wah lead voice with pitch change in the attack.
V-Q. Klav	C1 – G5	Funky electric clav sound. Initial touch affects the timbre.*	
3	V-SFX 1	---	Simulated hand-tapping of the open end of a pipe.
	V-SFX 2	---	Simulated scraping of a metallic plate. After Touch affects the degree of scraping.
	V-SFX 3	---	Simulated hitting of a metallic plate with a wood block. Initial Touch changes the apparent hardness of the wood block.
	V-SFX 4	---	Soft playing results in wind sounds. Applying keyboard pressure (After Touch) produces a distorted guitar sound.
	V-SFX 5	---	Jet noise. Applying keyboard pressure produces lead sound.
	V-SFX 6	---	Simulation of metallic plates colliding.
	V-SFX 7	---	Initial touch affects the resonance effect.
	V-SFX 8	---	Cry of a strange animal.
	V-SFX 9	---	Simulation of a thick and long hose.
	V-SFX 10	---	Trumpet with loop feedback sound.
	V-SFX 11	---	Initial touch produces the sound of hitting metal, and After Touch increase the noise.
	V-SFX 12	---	Initial touch produces the sounds of footsteps, and After Touch creates a windy sound.
	V-SFX 13	---	The sound of a soprano saxophone played in the distance. Playing with softer touch produces only breath noise.
	V-SFX 14	---	Lead sound with After Touch-produced pitch change.
	V-SFX 15	---	Initial touch produces the sound of metal being scraped, and After Touch creates noise.
	V-SFX 16	---	Cry/roar of an animal.

Each acoustic instrument has its own ideal note range. Keep in mind that playing outside of the range may create unexpected and unrealistic sounds.

Voices that do not have a specified ideal note range ("---" is shown in the chart above) can be played in any range and result in optimum sound with stable pitch.

* When the Feet parameter is set to 8', the resulting sound is actually 16'.



AWM Voices and VA Voices

The ELS-01C features two different types of Voices: AWM (Advanced Wave Memory) and VA (Virtual Acoustic).

VA Voices are available only on the Lead Voice 2 section while AWM Voices are available on all sections except Lead Voice 2.

AWM is a synthesis system based on sampled waves, or audio recordings of actual instruments. AWM Voices uses multiple samples, so that they sound like a real instrument.

On the other hand, VA synthesis applies sophisticated computer-based “physical modeling” technology to musical sound synthesis. VA Voices in this Electone offer many advantages in terms of musical performance, not just in terms of sound, but also in terms of the behavior that makes acoustic instruments so musical.

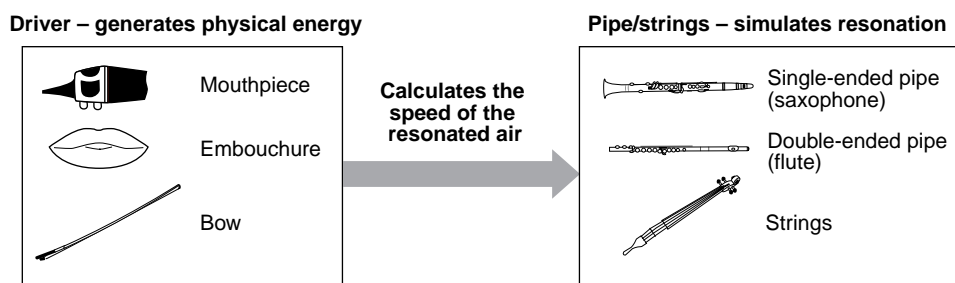

VA synthesis simulates the very complex vibrations, resonances, reflections and other acoustic phenomena that occur in an actual wind or string instrument.



Reference Page

Voice Edit (page 131)

Notes on VA Voices

Since the VA Voices have unique sonic characteristics and are closer in behavior to acoustic instruments than the AWM Voices, you should observe the following precautions when playing VA Voices.

- Some Voices may produce unexpected or unnatural sounds when played outside (higher or lower than) the recommended note range (pages 32 and 33).
- Pitch change may not be smooth on some Voices when Horizontal Touch is applied.
- Portamento (Lead Slide) effects may not be smooth on some Voices.
- Keep in mind that playing legato or trills may not produce any sound.

3 Organ Flutes (ELS-01C)

The ELS-01C has an Organ Flutes feature that allows you to create your own organ Voices, giving you access to an unlimited combination of organ sounds. With this function, you can recreate all of the classic organ sounds by adjusting the flute footage levels and the percussive sounds, just like on conventional organs. There are nine flute footage settings, with three additional footage settings for the attack sound.

1 Press one of the Organ Flutes buttons (UPPER or LOWER).

The lamp above the button lights and the Flute Footage Levers appear on the display.

On the ELS-01, [U. ORGAN FLUTES] and [L. ORGAN FLUTES] buttons are not active (Organ Flutes does not function).

FOOTAGE Page

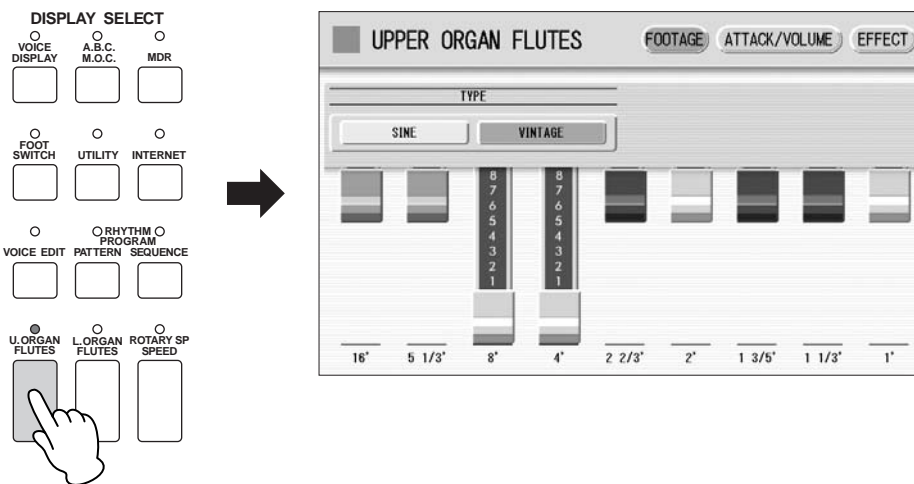

2 Select the wave type for the Organ Flute Voice.

Selecting [SINE] produces a clean, clear sound and selecting [VINTAGE] produces a gritty, slightly distorted sound.

3 Adjust flute footage settings (over a range of 0 – 8).

The Flute footage levers can be adjusted by directly touching the display. The Data Control dial cannot be used. Play the keyboard and listen to the changes in the sound as you adjust the footage levels.

4 Press the [ATTACK/VOLUME] button in the upper right on the display to adjust the volume.

ATTACK/VOLUME Page

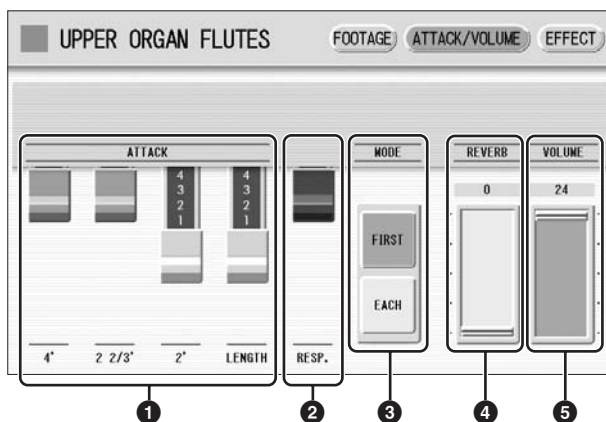

1 ATTACK

Determines the level of each volume in the percussive portion of the Voice. Footage settings are 4', 2-2/3' and 2'. The LENGTH lever determines the duration of the attack sound.

2 RESP. (Response)

Determines the overall speed of the keyboard response. Moving the lever downward makes the keyboard response slower, creating a pipe organ effect.

3 MODE

Determines which notes in a held group of notes are given an attack sound. This parameter is common to both Upper and Lower Organ Flute Voices.

FIRST: Only the first note played will have attack. All other notes played while the first is held have no attack.

EACH: All notes played have an attack sound.

4 REVERB

Determines the amount of reverb applied to the Organ Flute Voice. When the panel REVERB control is set to the minimum, the setting here will have no effect.

5 VOLUME

Determines the overall volume of the Organ Flute Voice. The volume balance of the individual footages is maintained. A minimum setting here produces no Organ Flute sound.



Reference Page

Reverb (page 43)

5 Press the [EFFECT] button at the top right of the display for the Rotary Speaker settings.

EFFECT Page

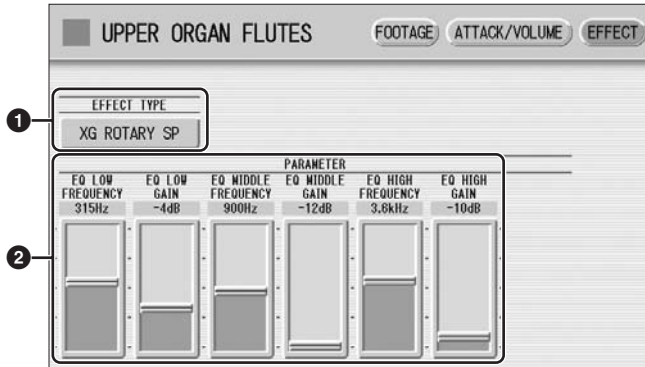

6 EFFECT TYPE

Selects the Rotary Speaker (tremolo) effect type. Press the EFFECT TYPE button to call up a list of the effect types. Select the desired type from the list.

To abort the operation, press the [CLOSE] button.



Reference Pages

Effect List (page 50)

Rotary Speaker (page 48)

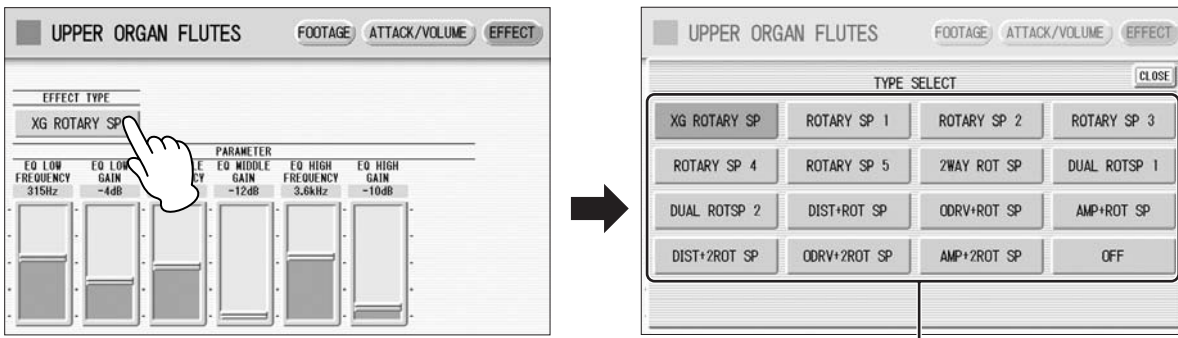

Select the desired effect type

2 Effect Parameters

Effect parameters are displayed corresponding to the selected effect type.

6 Press one of the Organ Flutes buttons (UPPER or LOWER) to cancel the Organ Flute function (the lamp above the button turns off).

The Electone is equipped with two general kinds of functions that can be used to change the sound of the Voices: Voice Controls and Effects.

Each Voice has been given certain factory-preset effect settings to best enhance its sound. However, if you wish, you can change the sound to suit your preferences by using the controls and effects described in this section. All built-in effects are digital.

The chart below shows the various Voice controls and effects for the individual Voice sections. Available functions are indicated by circles. The controls and effects are applied differently according to the different types: independently for each Voice section, independently for each keyboard or globally for the entire system.

Controls and Effects		Reference page for changing the settings	Voice sections to which the controls/effects are applied					
			Upper Keyboard		Lead Voice	Lower Keyboard		Pedalboard
			Upper Keyboard Voice 1, 2	Organ Flute Voice	Lead Voice 1, 2	Lower Keyboard Voice 1, 2	Organ Flute Voice	Pedalboard Voice 1, 2
Selecting from the Voice Condition display	Pan	page 39	○	—	○	○	—	○
	Touch Tone	page 39	○	—	○	○	—	○
	Pitch	page 40	○	—	○	○	—	○
	Feet	page 40	○	—	○	○	—	○
	Reverb (send level)	page 40	○	○	○	○	○	○
	Volume	page 40	○	○	○	○	○	○
	Priority*	page 40	—	—	○*	—	—	—
	Poly (Pedal polyphonic mode)	page 40	—	—	—	—	—	○
	Vibrato	page 41	○	—	○	○	—	○
	Touch Vibrato	page 41	○	—	○	○	—	○
	Lead Slide	page 42	○	—	○	—	—	—
	Transpose	page 42	○	—	○	○	—	○
	Tune	page 42	○	—	○	○	—	○
	Effect (1/2)	page 42	○	○ (Rotary Speaker only)	○	○	○ (Rotary Speaker only)	○
Selecting from the panel	Reverb	page 43	○					
	Sustain	page 47	○	—	○	○	○	
	Brilliance	page 47	○	—	○	○	○	
	Rotary Speaker	page 48	○					

* Priority is applied only for Lead Voice 2.

Contents

1 Selecting from the Voice Condition display	39
2 Selecting from the panel	43
3 Effect List.	50

1 Selecting from the Voice Condition display

Choose a Voice on the panel, then press the same button on the panel again (or press the name of the selected Voice in the display). The Voice Condition display appears. Voice Condition Display for each Voice has four pages that can be switched by pressing [1] – [4] buttons at the top right of the display.

Voice Condition [Page 1]

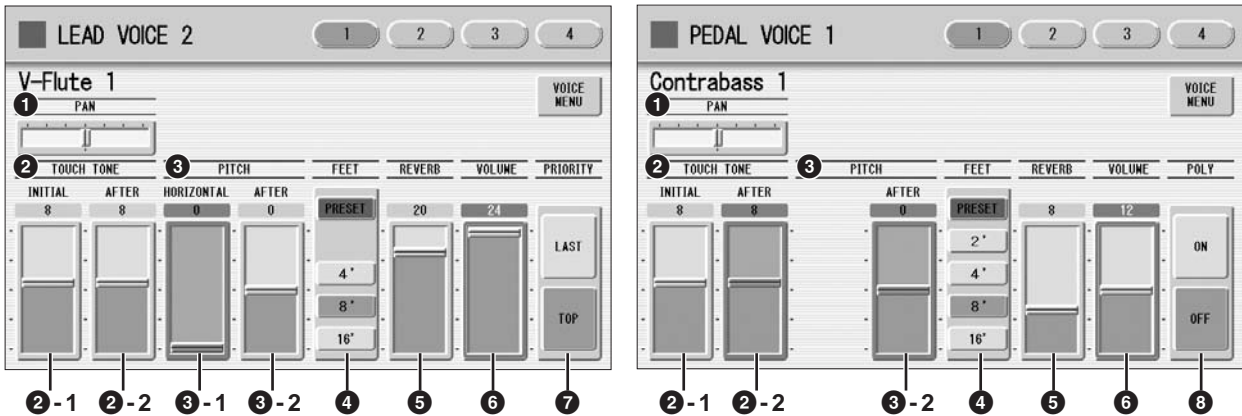

In this display, you can adjust the basic Voice controls, including panning, touch tone and volume. The displays of the various Voice sections have slight differences in their functions.

1 PAN

Determines the position of the Voice in the stereo image. Seven pan positions are available.

2 TOUCH TONE

The Touch Tone function gives you expressive control over the volume and timbre of a Voice. All Voices are provided with this expressive function, making it possible to perfectly reproduce the subtle dynamic and tonal changes of actual instruments. Two types of keyboard touch affect this function: Initial Touch and After Touch.

2 -1 INITIAL touch

Controls volume and timbre according to the velocity at which you play the keys. The harder you play the keys, the greater the volume and the brighter the timbre will become.

Higher settings make the change wider. Minimum setting produces no effect.

Range: 0 – 14

2 -2 AFTER touch

Controls volume and timbre according to the pressure you apply to the keys after playing them.

The harder you press down on the keys, the greater the volume and the brighter the timbre will become.

Higher settings make the change wider. Minimum setting produces no effect.

Range: 0 – 14



NOTE

Initial Touch may not be effective on some organ Voices.



NOTE

On the ELS-01, After Touch is not applied to the Pedal Voices.



NOTE

After Touch has no effect on percussive Voices (such as piano or vibraphone), percussion sounds, or some organ Voices.

3 PITCH

Controls pitch according to the play style of Horizontal Touch or After Touch. On some Voices in the Lead Voice 2 section, not only pitch but also timbre may be affected.



NOTE

Parameters that are available only on the ELS-01C are indicated by a dark frame and background in their display controls.

3 -1 HORIZONTAL touch (ELS-01C)

Controls the pitch by holding down the key and moving it laterally (wiggling your finger from side to side). The faster you move the key laterally, the faster and greater the pitch change becomes, within a range of +/- one octave. You can use this function in combination with Touch Tone described above to add expressiveness to your performance.

Higher settings result in a wider pitch change. The minimum setting produces no effect. This function is not available on the Pedalboard.

Range: 0 – 14

3 -2 AFTER touch

Controls the pitch according to the pressure you apply to the keys after playing them.

The minimum setting produces no effect at all. Higher (positive) settings make the pitch higher according to the pressure and lower (negative) settings make the pitch lower. The setting of +14 or -14 results in the widest pitch change.

Range: -14 – +14

4 FEET

Determines the octave setting of the Voice, letting you use the Voice over a wide register. There are three settings: 4', 8' and 16' (4' is highest and 16' is lowest). A 2' setting is added to the Pedal Voice sections. PRESET is the original (factory) setting.

5 REVERB

Determines the amount of reverb applied to each Voice section. When the panel REVERB control is set to the minimum, the setting here will have no effect. See page 43 for details.

6 VOLUME

Fine adjustment of the Voice volume. See page 25 for more information.

7 PRIORITY (only for the Lead Voice 2)

Determines the mode of Lead Voice 2, Last or Top.

LAST: Only the last played key is sounded when two or more keys are played simultaneously.

TOP: Only the highest note is sounded when two or more keys are played simultaneously. When the Solo mode is on, Lead Voice 2 sounds according to Last mode, regardless of the setting made here.



Reference Page

Solo function (page 27)

8 POLY (only for Pedal Voices)

Allows you to switch the pedal polyphonic mode on or off. Setting POLY to on switches the normally monophonic pedal Voices to polyphonic play. This makes it possible to play the Pedalboard in various expressive ways, such as playing legato or playing intervals and chords.

Keep in mind that you cannot exceed the total maximum polyphony: 14 notes for all sections, Upper, Lower and Pedal.

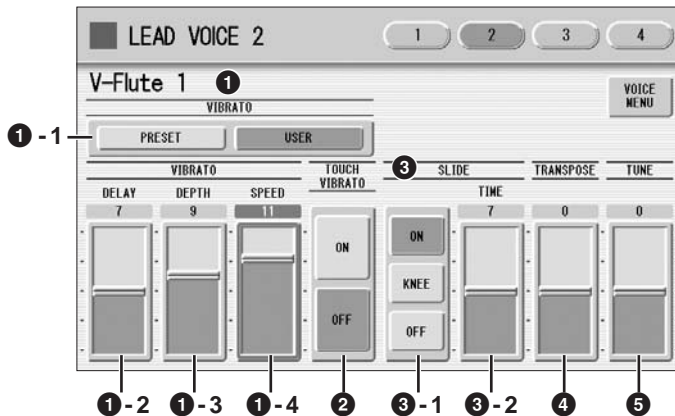

The items included in this page differ between the Lead Voice sections and the other sections. SLIDE (3) only applies to Lead Voice 1 and 2.

1 VIBRATO

The Vibrato function wavers the level of the Voices, making them sound warmer and more animated. This effect is applied independently to each Voice section. For some Voices, vibrato may not be effective at all or the effect may not sound as expected.

1 - 1 PRESET/USER

Selecting PRESET calls up the original (factory) vibrato settings for the Voice. When PRESET is selected, DELAY, DEPTH and SPEED parameters cannot be edited.

Selecting USER lets you adjust the vibrato settings for yourself.

Vibrato Control

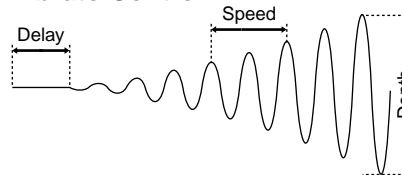

1 - 2 DELAY

Determines the amount of time that elapses between the playing of a key and the start of the vibrato effect. Higher settings increase the delay of the vibrato onset.

Range: 0 – 14

1 - 3 DEPTH

Determines the intensity of the vibrato effect. Higher settings result in a more pronounced vibrato. The minimum setting cancels the vibrato effect.

Range: 0 – 14

1 - 4 SPEED

Determines the speed of the vibrato effect. Higher settings increase the speed of the vibrato.

Range: 0 – 14

2 TOUCH VIBRATO

Turns the Touch Vibrato function on or off. Setting Touch Vibrato to on lets you apply vibrato to individual notes as you play them by after touch. The harder you press down the key, the greater the vibrato will be. When Touch Vibrato is off, vibrato depth cannot be controlled, no matter how hard you press the keys.



NOTE

Touch Vibrato is not applied to the Pedal Voices of the ELS-01.



Reference Page

Controlling Lead Slide (with Knee Lever); (page 190)

3 SLIDE (only for Lead Voices)

Applies a portamento effect to notes played in legato. The Slide function is effective within a one-octave range for Lead Voices. Slide has no effect when playing notes beyond a one-octave range.

3 - 1 ON/KNEE/OFF

On/Off switch and knee lever selector for the Slide effect.

3 - 2 TIME

Determines the speed of the slide or portamento effect. Higher settings makes the slide speed slower.

Range: 0 – 14



Reference Page

Transpose (for entire instrument); (page 193)

4 TRANSPOSE

Changes the pitch in semitones for each Voice section. Range is from -6 to +6.



Reference Page

Pitch (for entire instrument); (page 193)

5 TUNE

Determines the fine pitch settings (detune) for each Voice section, producing a richer sound. Each step represents a 1-cent change in pitch.

Range: -64 – +63

Voice Condition [Page 3, 4]

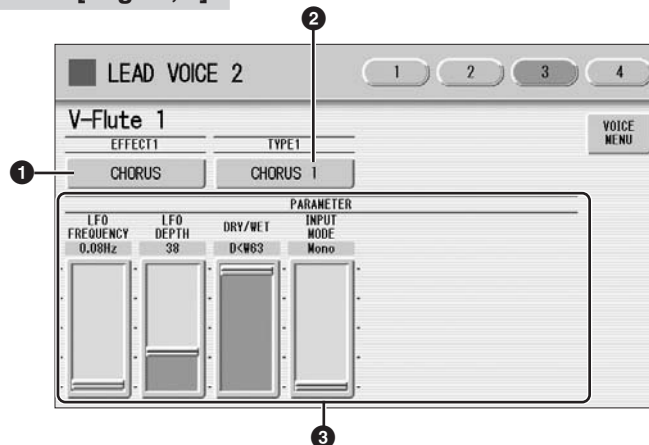

You can edit the effect parameters from these two displays. Both displays have the same contents. You can select two effects for each Voice section with these displays (Voice Condition Pages 3 and 4).



Reference Page

Effect List (page 50)

1 EFFECT 1 (Page 3)/EFFECT 2 (Page 4)

Selects the effect category. Pressing the effect button on the display calls up the effect category list. Select the desired effect category from the list.

To abort the operation, press the [CLOSE] button.

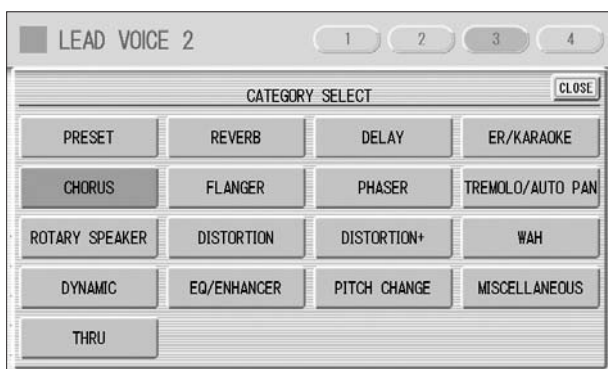

By selecting [PRESET] in the list, the original (factory) effect category for the selected Voice is automatically set. Selecting [THRU] bypasses the effect (no effect is added to the selected Voice).

2 TYPE 1 (Page 3)/TYPE 2 (Page 4)

Determines the type of the effect. Pressing the TYPE button on the display calls up the effect type list, corresponding to the selected effect category. Select the desired effect type from the list.

To abort the operation, press the [CLOSE] button.

If you have selected the [PRESET] category, the effect type cannot be edited.

After changing the effect type, the effect parameter below is automatically changed corresponding to the selected effect type.

3 Effect Parameters

Effect parameters are displayed corresponding to the selected effect type.

2 Selecting from the panel

The Reverb, Sustain and Rotary Speaker displays are called up by pressing the respective buttons on the panel.

Reverb

Reverb adds an echo-like effect to the sound, giving the impression of a performance in a large room or concert hall. You can adjust the reverb volume for each Voice sections, or adjust the reverb volume for rhythm and accompaniment separately.

To adjust the reverb effect and call up the Reverb pages:

Press one of the REVERB buttons, located to the left of the panel, to set the Reverb effect. The Reverb display appears.

The Reverb display consists of four pages.

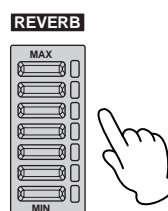

REVERB [Page 1]



NOTE

Depending on the reverb depth value (set by the slider), two adjacent REVERB button lamps may be lit at the same time, indicating an intermediate position.

DEPTH:

Fine adjustment of the depth of reverberation or the level of the reflected sounds.

Coarse reverb depth settings are made with the panel REVERB buttons. The REVERB buttons let you make coarse adjustment in seven settings to the reverb depth while the slider gives you fine control.

When this parameter or the panel REVERB control is set to the minimum, the settings in the pages that follow have no effect.

Range: 0 – 24

REVERB [Page 2]

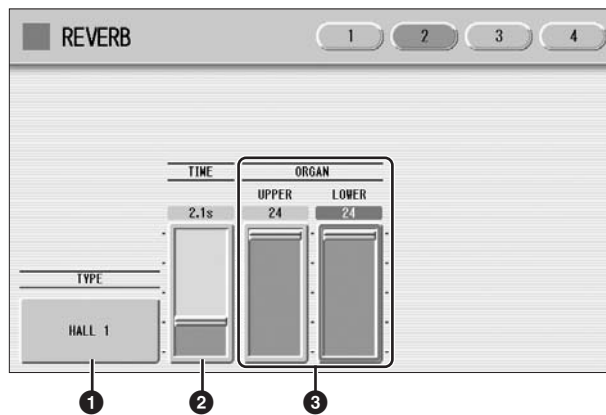

Reference Page

Effect List (page 50)

1 TYPE

Determines the reverb type for each of the Voice sections and the Organ Flute Voice.

Several types can be selected: Room, Hall, Stage, and so on.

Pressing the TYPE button on the display calls up the Reverb Type list.

Press the number buttons to change the display pages.

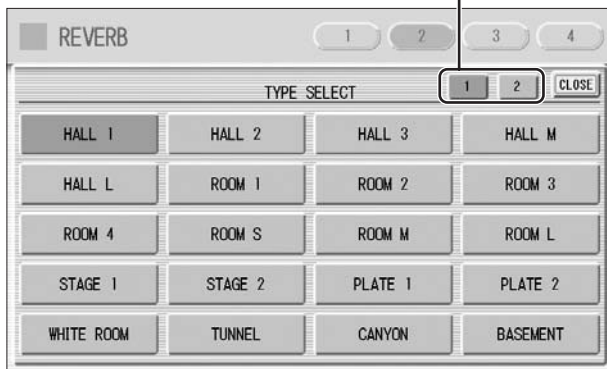

The list contains many reverb types, more than can fit on one display page. To change the display pages, press the appropriate number buttons [1] or [2] in the display. Select the desired reverb type from the list.

To abort the operation, press the [CLOSE] button.

After changing the reverb type, the TIME parameter below is automatically changed corresponding to the selected reverb type.

2 TIME

Determines the reverb length for each of the Voice sections and the Organ Flute Voice. Higher settings increase the reverberance.

Range: 0.3s – 30.0s

3 ORGAN (only for the ELS-01C)

Determines the amount of reverb applied to the Organ Flute Voice. This parameter corresponds to the REVERB slider contained in the ATTACK/VOLUME Page of the Organ Flute display.

On the ELS-01, this slider is not displayed.

Range: 0 – 24



Reference Page

Organ Flutes (page 35)

REVERB [Page 3]

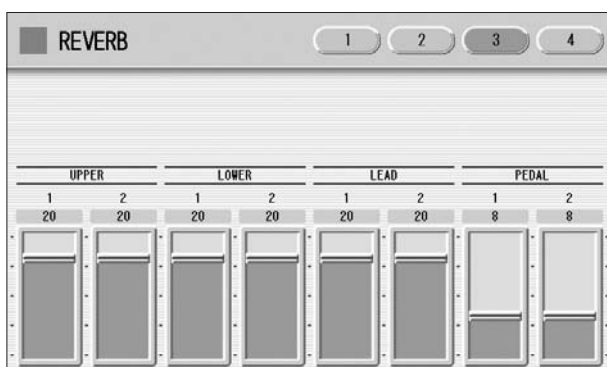

Determines the amount of reverb effect applied to each Voice section. Each slider corresponds to the REVERB slider in Voice Condition Page 1 of the respective Voices.

Range: 0 – 24

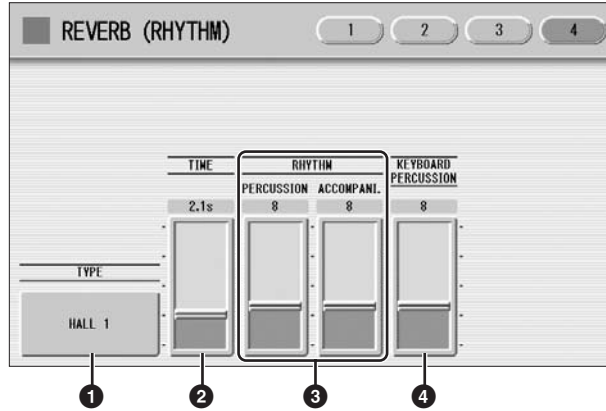

Reference Page

Connecting a Microphone or Guitar (page 214)

1 TYPE

Determines the reverb type for rhythm, accompaniment, keyboard percussion, and microphone signal.

2 TIME

Determines the length of reverb applied to the rhythm, accompaniment, keyboard percussion, and microphone signal.

Range: 0.3s – 30.0s

3 RHYTHM

Determines the amount of reverb applied to the rhythm (with PERCUSSION slider) and accompaniment (with ACCOMPANI. slider). Each slider corresponds to the REVERB slider in the Rhythm Condition display.

Range: 0 – 24

4 KEYBOARD PERCUSSION

Determines the amount of reverb applied to the Keyboard Percussion.

Range: 0 – 24



Reference Pages

Changing the rhythm reverb (page 57)

Keyboard Percussion (page 65)

Sustain

The sustain effect, selectable for each Voice section, causes Voices to gradually fade out when the keys are released. The sustain on/off and sustain length settings are independent for each keyboard, providing maximum expressive control.

The Knee Lever can also be used to switch the sustain on/off. Sustain cannot be applied to the Lead Voices.



Reference Page

Knee Lever (page 188)

To add sustain to the Voices and call up the Sustain Length page:

Press one of the SUSTAIN buttons, located to the left of the panel, to set the sustain. The Sustain Length display appears.

The lamp of the button lights up to indicate that sustain is on. Press the button again to turn sustain off and the lamp turns off. When the lamp is off, sustain does not affect the corresponding keyboard. Remember to check whether the sustain button lamps are on or off before you start to play.

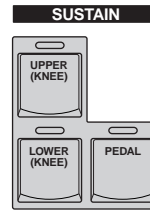

SUSTAIN LENGTH Display

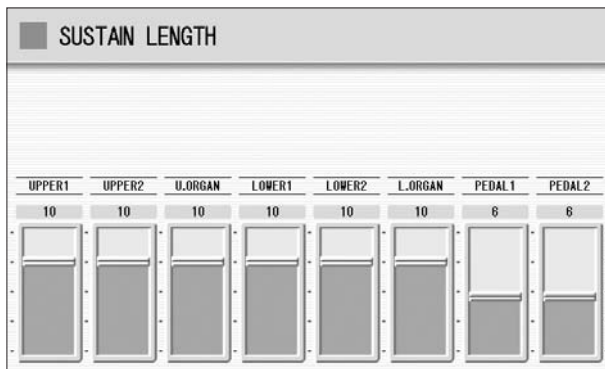

To adjust the sustain length value, use the display slider. If you set the highest value (HOLD), some Voices such as organ or synth will sound continuously even when the keys are released.

Range: 0 – 12, HOLD



NOTE

If you change the Voice when the sustain length is set to HOLD and the keys are released, the Voice only changes after you play another key.



NOTE

When the sustain length is set to HOLD, previously played note(s) may be cut off by subsequently played notes.



NOTE

The minimum setting results in no sustain. Turning sustain off automatically resets the sustain length to be the default setting.

Brilliance

Adjustment of the Voice tone, brighter or mellower.

Press the BRILLIANCE buttons of each Voice section on the panel to set the desired brilliance for each Voice.

The buttons have seven brilliance settings.

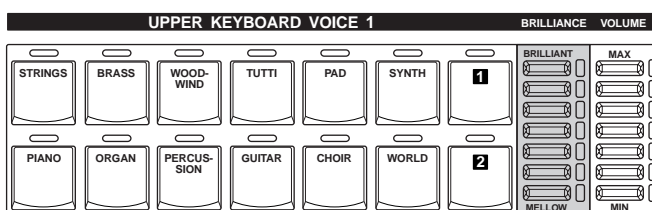

Rotary Speaker

Rotary Speaker recreates the rich, swirling sound of the popular rotating speaker effect. The Rotary Speaker effect can be switched in real time as you play, with either the front panel button or the Left Footswitch (when properly set for Footswitch operation). The Rotary Speaker effect CANNOT be turned on only by turning on the [ROTARY SP SPEED] button. The following procedure is needed to use the Rotary Speaker effect.

1 Select the Rotary Speaker effect from the desired Voice.

When you want to set Rotary Speaker to one of the Voice section, you can select the effect category of Rotary Speaker in the Voice Condition Display Page 3 or 4. See page 42 for details.

Select "Rotary Speaker" here.

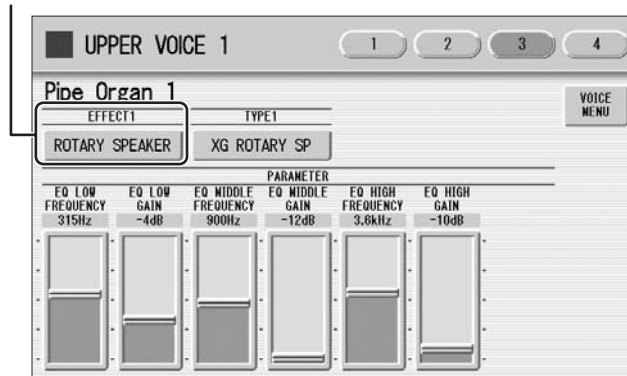

When you want to set Rotary Speaker for the Organ Flute Voice, select the effect type in the EFFECT Page. See page 37 for details.

Select an effect type other than [OFF].

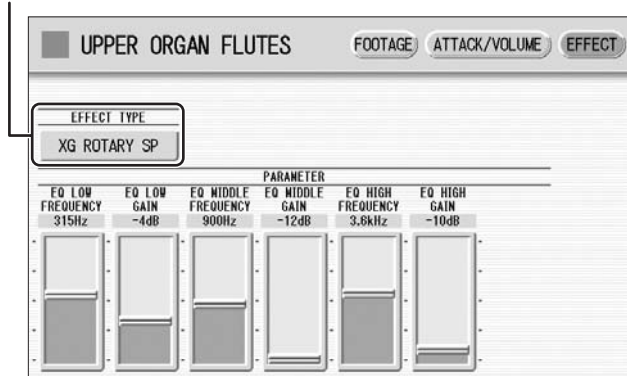

2 Adjust the rotating speed and mode of the Rotary Speaker.

Press the [ROTARY SP SPEED] button on the panel. The ROTARY SPEAKER display appears. The settings in this display are common to all Voice sections.

ROTARY SPEAKER Display

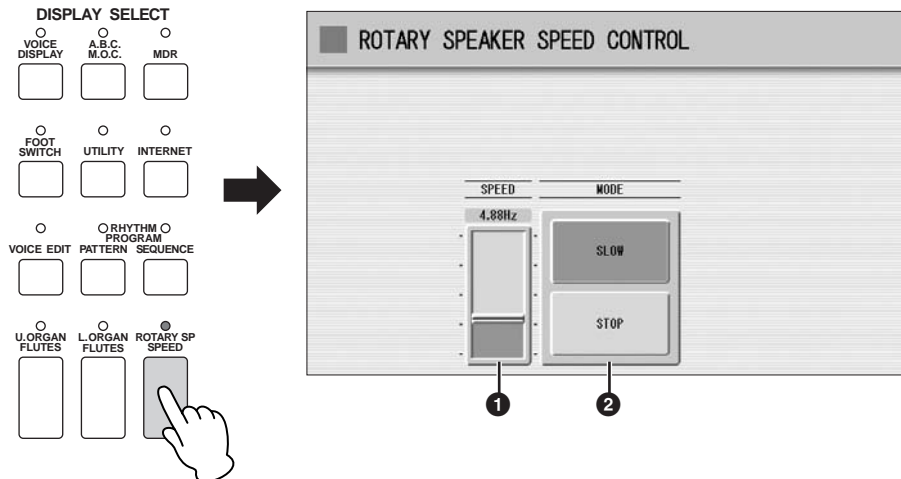

1 SPEED

Determines the speed of the speaker rotation.

Range: 2.69Hz – 39.7Hz

2 MODE

Determines the slow/stop mode when [ROTARY SP SPEED] button is off. If [SLOW] is selected, a slow chorus effect is applied when you turn off the button on the panel. If [STOP] is selected, the Rotary Speaker effect turns off when you turn off the button on the panel.

Once the Rotary Speaker effect has been turned on and set, you can control the effect in real time from the panel or from the Left Footswitch.

3 Control the Rotary Speaker effect from the panel or from the Left Footswitch.

You can control Rotary Speaker on/off not only from the panel but also the Left Footswitch, if the Footswitch has been properly assigned. See page 188 for details.

3 Effect List

REVERB		
1	HALL 1	
	HALL 2	
	HALL 3	
	HALL M	
	HALL L	
	ROOM 1	
	ROOM 2	
	ROOM 3	
	ROOM 4	
	ROOM S	
	ROOM M	
	ROOM L	
	STAGE 1	
	STAGE 2	
	PLATE 1	
	PLATE 2	
	WHITE ROOM	
	TUNNEL	
	CANYON	
	BASEMENT	
	2	XG HALL 1
		XG HALL 2
		XG ROOM 1
		XG ROOM 2
XG ROOM 3		
XG STAGE 1		
XG STAGE 2		
XG PLATE		
GM PLATE		
DELAY		
DELAY LCR		
XG DLY LCR		
DELAY LR		
ECHO		
CROSS DELAY		
TEMPO DELAY		
TEMPO ECHO		
TEMPO CROSS		
ER/KARAOKE		
ER 1		
ER 2		
GATE REVERB		
REVERS GATE		
KARAOKE 1		
KARAOKE 2		
KARAOKE 3		
CHORUS		
CHORUS 1		
CHORUS 2		
XG CHORUS 1		
XG CHORUS 2		

XG CHORUS 3	
XG CHORUS 4	
GM CHORUS 1	
GM CHORUS 2	
GM CHORUS 3	
GM CHORUS 4	
FB CHORUS	
CELESTE 1	
CELESTE 2	
CELESTE 3	
CELESTE 4	
SYMPHONIC	
XG SYMPHONIC	
ENS DETUNE	
FLANGER	
FLANGER 1	
FLANGER 2	
XG FLANGER 1	
XG FLANGER 2	
XG FLANGER 3	
GM FLANGER	
V_FLANGER	
TEMP FLANGER	
DYNA FLANGER	
PHASER	
PHASER 1	
PHASER 2	
EP PHASER 1	
EP PHASER 2	
EP PHASER 3	
TEMPO PHASER	
DYNA PHASER	
TREMOLO/AUTO PAN	
TREMOLO 1	
TREMOLO 2	
XG TREMOLO	
EP TREMOLO	
GT TREMOLO 1	
GT TREMOLO 2	
ORGAN TREMOLO	
AUTO PAN	
XG AT PAN 1	
XG AT PAN 2	
EP AUTO PAN	
ROTARY SPEAKER	
XG ROTARY SP	
ROTARY SP 1	
ROTARY SP 2	
ROTARY SP 3	
ROTARY SP 4	
ROTARY SP 5	
2WAY ROT SP	

DUAL ROTSP 1	
DUAL ROTSP 2	
DIST+ROT SP	
ODRV+ROT SP	
AMP+ROT SP	
DIST+2ROT SP	
ODRV+2ROT SP	
AMP+2ROT SP	
DISTORTION	
DIST HARD 1	
DIST HARD 2	
DIST SOFT 1	
DIST SOFT 2	
ST DIST HARD	
ST DIST SOFT	
OVERDRIVE	
ST OVERDRIVE	
XG DIST	
XG ST DIST	
V_DIST HARD	
V_DIST SOFT	
COMP+DIST	
XG CMP+DIST	
AMP SIM	
XG AMP SIM	
ST AMP SIM 1	
ST AMP SIM 2	
XG ST AMP	
DISTORTION+	
DIST+DELAY	
ODRV+DELAY	
XG DIST+DLY	
XG ODRV+DLY	
CMP+DIST+DLY	
CMP+ODRV+DLY	
XG CMP+DT+DL	
XG CMP+OD+DL	
V_DIST H+DLY	
V_DIST S+DLY	
DIST+T DLY	
ODRV+T DLY	
CMP+DST+TDLY	
CMP+OD+TDLY	
V_DST H+TDLY	
V_DST S+TDLY	
WAH	
AUTO WAH	
XG AUTO WAH	
TOUCH WAH 1	
TOUCH WAH 2	
AT WAH+DIST	
XG AT WH+DST	

AT WAH+ODRV	
XG AT WAH+OD	
TC WAH+DIST	
XG TC WH+DST	
TC WAH+ODRV	
XG TC WAH+OD	
CLAVI TC WAH	
EP TOUCH WAH	
WAH+DST+TDLY	
WAH+OD+T DLY	
WAH+DIST+DLY	
XG WH+DST+DL	
WAH+ODRV+DLY	
XG WH+OD+DLY	
DYNAMIC	
M BAND COMP	
COMPRESSOR	
NOISE GATE	
EQ/ENHANCER	
ST 2BAND EQ	
ST 3BAND EQ	
XG 3BAND EQ	
EQ DISCO	
EQ TEL	
HM ENHANCER	
XG HM ENHNCE	
PITCH CHANGE	
PITCH CHANGE	
XG PCH CHG 1	
XG PCH CHG 2	
MISCELLANEOUS	
AMBIENCE	
IMPULSE EXP	
RESONATOR	
VOICE CANCEL	
TALKING MOD	
LO-FI	
DYNA FILTER	
DYNA RINGMOD	
RING MOD	
ISOLATOR	
THRU	
THRU	

This Electone features 274 different real rhythms featuring actual drum and percussion sampled sounds. Automatic Accompaniment functions are used with the rhythms, providing appropriate and completely automatic accompaniment to match the style of the selected rhythm. Moreover, the Electone has a Keyboard Percussion feature that allows you to play drum and percussion sounds from the Upper, Lower keyboard and Pedalboard.

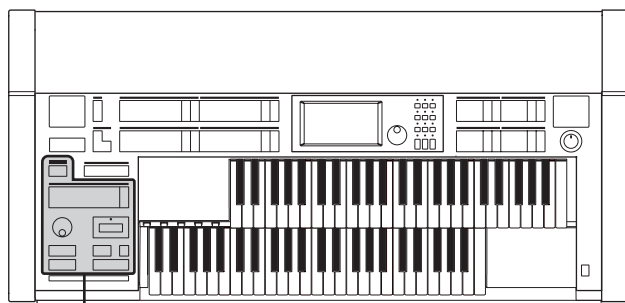

Rhythm/Keyboard Percussion

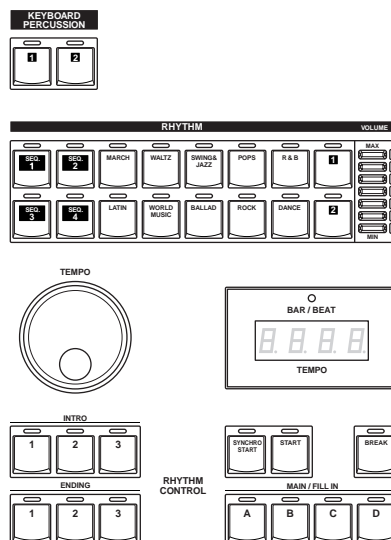

Contents

1 Selecting rhythms with the Rhythm buttons	51	5 Automatic Accompaniment – Auto Bass Chord (A.B.C.) 62
• Selecting a rhythm	51	6 Melody On Chord (M.O.C.)
• Operating the rhythm from the panel.	53	64
• Changing the rhythm volume	55	7 Keyboard Percussion
• Adjusting the tempo	56	65
• Changing the rhythm reverb	57	• Using the Preset Keyboard Percussion
2 Selecting rhythms from the User buttons	58	• Preset Keyboard Percussion List
3 Rhythm List	59	• Assigning sounds to the User Keyboard Percussion
4 Accompaniment	61	• Copying the Keyboard Percussion settings
		• Detailed settings for each percussion instrument.
		• Kit Assign List
		76

1 Selecting rhythms with the Rhythm buttons

A total of 274 rhythms can be instantly selected with the ten rhythm buttons on the front panel.

Selecting a rhythm

In the explanation below, 16Beat 1 in the POPS category is selected as an example.

- 1 Press one of the Rhythm buttons in the RHYTHM section on the front panel (for example, the [POPS] button).

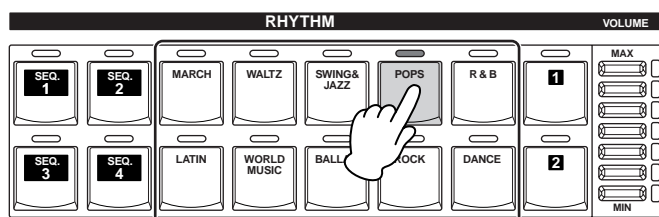

Rhythm buttons

The relevant Rhythm Menu is displayed.

2 Select the desired rhythm name from the Rhythm menu.

The Rhythm menu contains many Pops rhythms, more than can fit on the display page. To change the display pages, press the appropriate number buttons in the display.

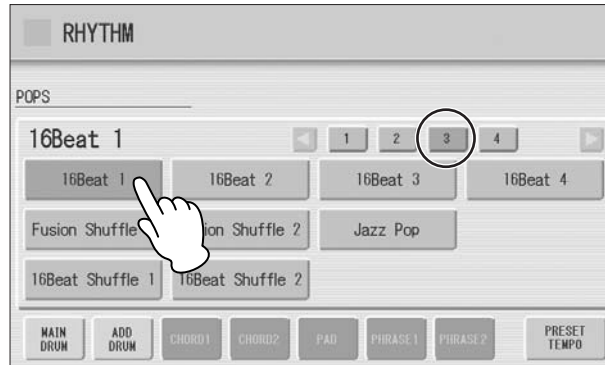

The color of the selected rhythm name changes to orange, indicating that it has been selected.

Rhythm Structure

Each rhythm is made up of “sections.” Since each section is a rhythmic variation of the basic rhythm, you can use them to add “spice” to your performance and mix up the beats while you are playing. You can freely change the section while the rhythm is played back.

INTRO

This is used for the beginning of the song. There are three Intro sections that can be selected with INTRO [1] – [3] buttons. When the Intro finishes playing, the rhythm automatically shifts to the Main section.

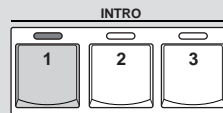

Selected Intro section's lamp is lit

MAIN

This is used for playing the main part of the song. There are four Main sections that can be selected with MAIN/FILL IN [A] – [D] buttons. The rhythm pattern of several measures repeats indefinitely.

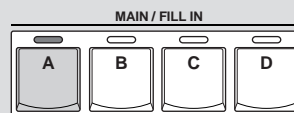

Selected Main section's lamp is lit

FILL IN

This is designed for use as a temporary and regular rhythmic pattern to spice up a repeating rhythm. There are four Fill In sections that can be played by pressing the selected (lit) MAIN/FILL IN [A] – [D] buttons as desired. When one measure pattern of Fill In finishes playing, the rhythm is automatically shifts to the Main section.

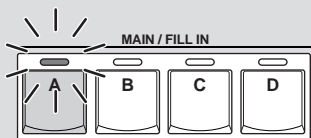

Selected Fill In section's lamp flashes

BREAK

This lets you add dynamic variations and breaks in the rhythm pattern. The Break section is selected by pressing the [BREAK] button. When the one-measure Break pattern finishes playing, the rhythm automatically shifts to the Main section.



The lamp is lit when the Break section is selected

ENDING

This is used for the ending of the song. There are three Ending sections that can be selected with the ENDING [1] – [3] buttons. When the ending is finished, the rhythm automatically stops.

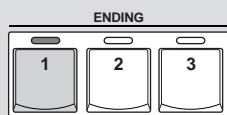

Selected Ending section's lamp is lit

Operating the rhythm from the panel

You can turn the rhythm on/off and switch the sections as desired by pressing the buttons on the panel. Using the Fill Ins and Break patterns let you add dynamic interest and “spice” to your performance.

To start/stop the rhythm:

START

The rhythm begins as soon as the [START] button is pressed.
To stop the rhythm, press the button again.

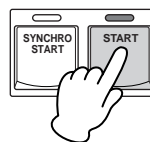

SYNCHRO START

The [SYNCHRO START] button puts the rhythm in “standby.”
The rhythm starts when you press a note on the Lower keyboard or Pedalboard.

When the A.B.C. mode is set to OFF, pressing the [SYNCHRO START] button again stops the rhythm.

When the A.B.C. mode is set to something other than OFF, releasing the key from the Lower keyboard or Pedalboard stops the rhythm.

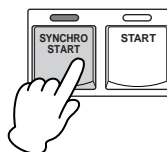

Reference Page

Automatic Accompaniment –
Auto Bass Chord (A.B.C.)
(page 62)

INTRO

Pressing one of the INTRO [1] – [3] buttons automatically adds a short introduction before starting the actual (Main) rhythm. First press one of the INTRO [1] – [3] buttons, then press the [START] or [SYNCHRO START] button to actually start the rhythm.

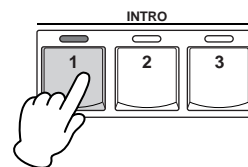

While the introduction is playing, the BAR/BEAT display shows the countdown to the first measure of the pattern. For example, if there is a four-measure lead-in for a pattern in 4/4 time, the display at right appears:

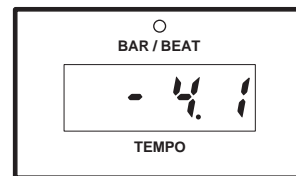

NOTE
When an Intro or Ending pattern is playing, the Lower Keyboard cannot be played.

ENDING

Pressing one of the ENDING [1] – [3] buttons automatically adds an ending phrase before stopping the rhythm.

When you press the Ending button while rhythm is playing back, the rhythm will automatically stop after the ending phrase is played. You can have the ending gradually slow down (ritardando) by pressing the ENDING button once again, while the ending is playing.

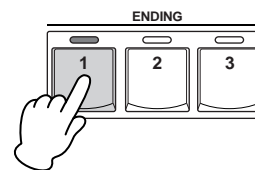

NOTE
Pressing the ENDING [1] button during playback of the Main section will first call up the fill in pattern, then the Ending 1 pattern.

To switch the rhythm sections:

You can change the rhythm section of the Main phrase by pressing the desired MAIN/FILL IN [A] – [D] button. The selected section's lamp (above the button) is lit.

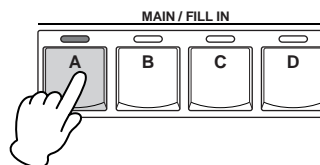

NOTE
You can record the currently selected section to Registration Memory. However, you cannot record the on/off status of the Auto Fill In function.

To use the Fill In patterns:

As you play the Electone along with the rhythm, occasionally press the selected MAIN/FILL button as desired. The Fill In pattern (one measure) will be played and the selected Fill In section's lamp (above the button) flashes.

When you use the Auto Fill In function, Fill Ins will be played automatically. The Auto Fill In function is set in the Rhythm Condition display.

Pressing the selected Rhythm button on the panel again (or pressing the rhythm name of the selected rhythm in the display) calls up the Rhythm Condition Display.

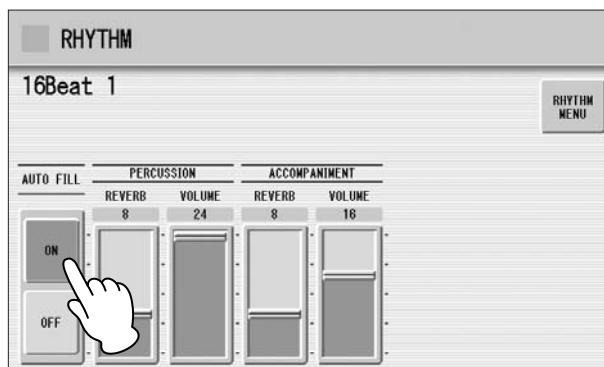

When Auto Fill is set to ON in the left side of the display, the Fill In pattern is automatically played whenever you switch the Main sections.

To use the Break patterns:

As you play the Electone along with the rhythm, occasionally press the [BREAK] button.

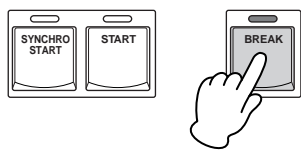

Moreover, you can start/stop the rhythm and switch the sections by using the Footswitch. See page 186 for details.

Changing the rhythm volume

There are two ways to set the rhythm volume: using the VOLUME buttons on the panel and using the volume slider in the display. The volume buttons let you make coarse adjustments to the volume while the slider gives you fine control.

Using VOLUME buttons on the panel (coarse):

Press one of the VOLUME buttons of the rhythm on the panel to set the desired level. The buttons have seven volume settings, from a minimum of 0, or no sound, to a maximum of full volume.

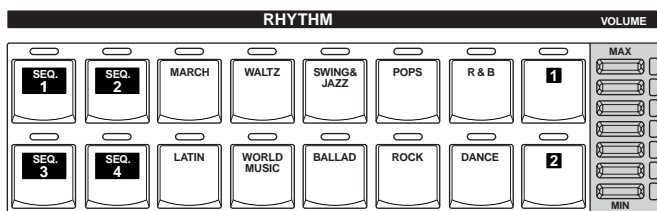

Using VOLUME slider in the display (fine):

Pressing the same rhythm button on the panel again (or pressing the rhythm name of the selected rhythm in the display) calls up the Rhythm Condition Display.

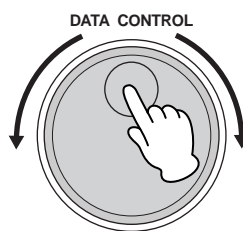
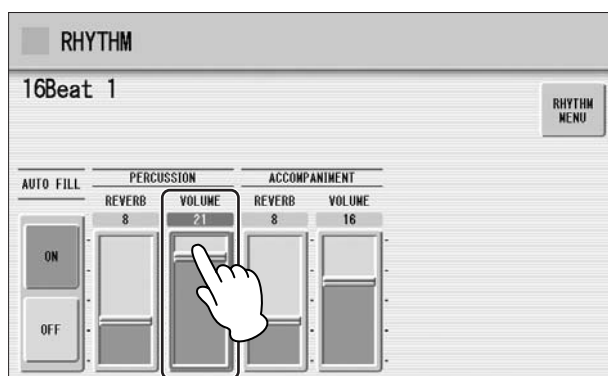

To set the volume, touch the PERCUSSION VOLUME slider in the display or use the Data Control Dial. The control range is from 0 (no sound) to 24 (full volume).



NOTE

Depending on the volume value (set by the slider), two adjacent VOLUME button lamps may be lit at the same time, indicating an intermediate position.

Adjusting the tempo

Turn the TEMPO dial clockwise to increase the tempo, and counter-clockwise to decrease it.

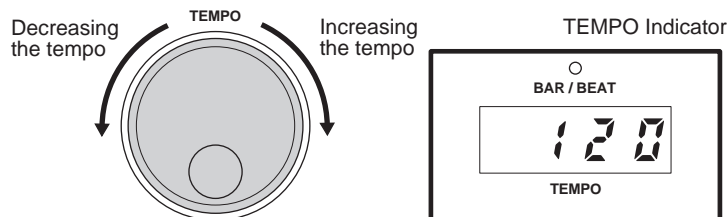

TEMPO display shows the current tempo. Displayed values are given in beats per minute.

The tempo range is 40 to 240 beats per minute.

When the rhythm begins playing, the TEMPO indicator changes function to a BAR/BEAT indicator.

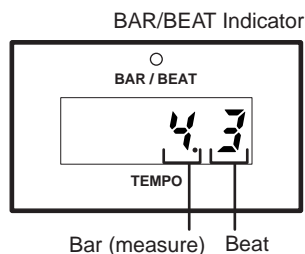

On the BAR/BEAT indicator, the number on the left indicates the current bar or measure and the one on the right indicates the number of the beat in each bar.



Reference Page

Voice Display (page 17)

You can also see the Tempo and Bar/Beat indications in the Voice Display. In the Voice Display, both Tempo and Bar/Beat can be seen in one display.

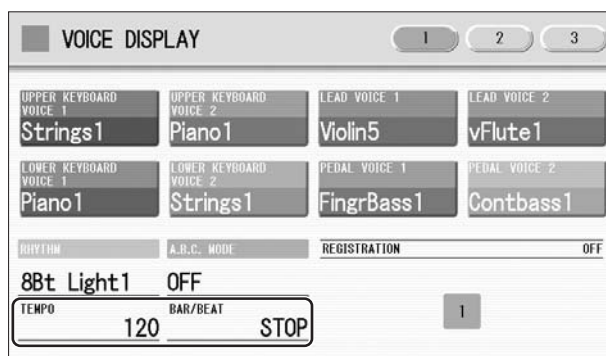
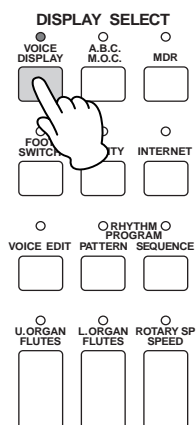

Each rhythm has its original (preset) tempo. Press [PRESET TEMPO] button in the display to restore the tempo to the original setting.

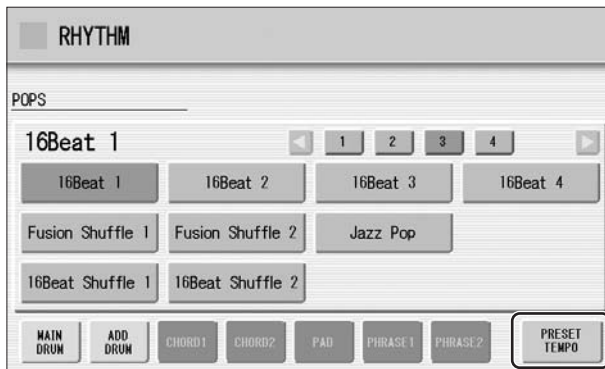

Changing the rhythm reverb

You can adjust the amount of reverb applied to the rhythms and the percussion sounds used in the rhythms in the Rhythm Condition display.



Reference Page

Reverb (page 43)

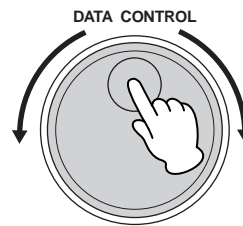
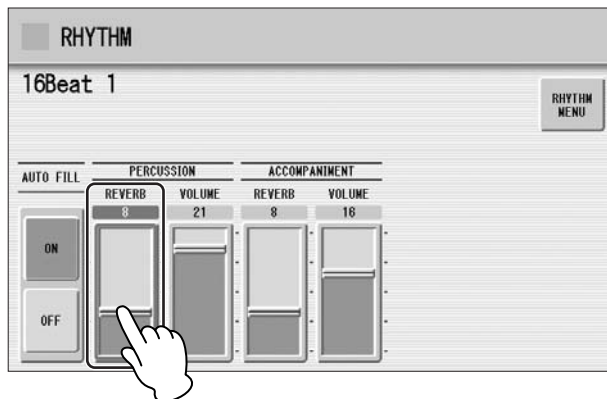

When the panel REVERB control is set to the minimum, the setting here will have no effect.

Range: 0 – 24

2 Selecting rhythms from the User buttons

As with the Voice sections, the Rhythm section also has User buttons (numbered 1 or 2) from which rhythms can be selected. You can select original User rhythms that you have created with the Rhythm Pattern Program function. This also allows you to assign two or three rhythms from the same category to be selected from different buttons; one from the original Rhythm button, and the others from the User buttons.

- 1 Press one of the User buttons at the right of the Rhythm buttons.

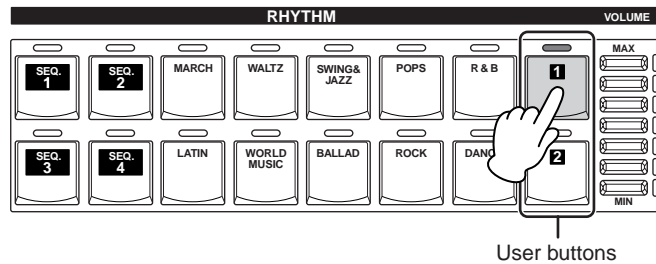

The Rhythm Menu appears in the display.

- 2 Select the desired rhythm category with the category buttons in the display.

You can also choose the “User” category to select a User rhythm you have created.

The currently selected rhythm category appears at the top left of the display. The rhythm name shown below the category name is that of the currently assigned rhythm and is irrelevant to the rhythm category.

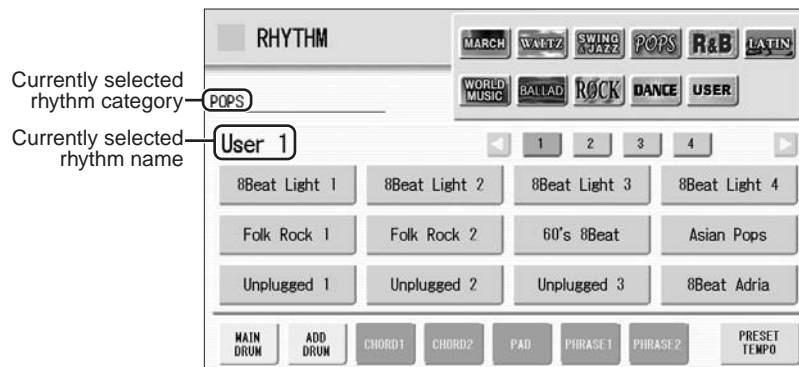

- 3 Select a rhythm from the displayed Rhythm Menu.

Pressing the number buttons in the display calls up the other rhythms in the category.



Reference Page

Rhythm Pattern Program
(page 144)

3 Rhythm List

This list shows all available rhythms on the Electone. Numbers written at the left side of each column in this list indicate the numbered buttons displayed in the Rhythm Menu.

MARCH								
1	Marching Band 1	2	Fast Jazz	2	British 16Beat	1	Bossa Nova 1	
	Marching Band 2		Combo Swing	16Beat 1	3		Bossa Nova 2	Bossa Nova 3
	Marching Band 3		Cool Combo	16Beat 2			Fusion Shuffle 1	Pop Bossa
	Alpine March		Light Swing	16Beat 3			Fusion Shuffle 2	Mambo 1
	6/8 March 1		Afro Cuban 1	16Beat 4		Jazz Pop	Mambo 2	
	6/8 March 2		Afro Cuban 2	16Beat Shuffle 1	16Beat Shuffle 1	Salsa 1		
	6/8 Kids		Bebop		16Beat Shuffle 2	Salsa 2		
	6/8 Organ March		Five-Four	Pop Shuffle	16Beat Shuffle 2	2	Montuno	
	Broadway	Jazz Ballad 1	Eurovision Pop		Calypso			
	SF March	Jazz Ballad 2	British Pop	4	Cha Cha Cha			
	Wild West	Movie Swing	Sing Along	Simple Shuffle 1	Big Band Cha Cha			
	Baroque	Piano Trio	Simple Shuffle 2	Simple Shuffle 2	Pop Cha Cha			
	WALTZ		3	Midnight Swing	R&B		3	Rumba
	1	Vienna Waltz		Slow Jazz	Blues Rock	Rumba		
		Orchestra Waltz		Moonlight 1	Motor City	Pop Rumba		
Simple Waltz		Moonlight 2		Soul 1	Fast Rumba			
Gentle Waltz		Winter Song 1		Soul 2	Guitar Rumba			
Guitar Serenade		Winter Song 2		16Beat Soul	Beguine 1			
Snow Waltz		Foxtrot		Frankly Soul	Beguine 2			
Classic Waltz		Slowfox		Gospel Funk	Cuban Bolero			
Mariachi		Quickstep	Jazz Funk	Tango 1				
Alpine Waltz		Dixieland 1	Funk Beat 1	Tango 2				
Musette		Dixieland 2	Funk Beat 2	Tango Orchestra				
2	Jazz Waltz 1	Dixieland Jazz	Detroit Pop 1	Tango Milonga				
	Jazz Waltz 2	Ragtime	Detroit Pop 2	WORLD MUSIC				
	Jazz Waltz 3	Charleston	New R&B	Bolero				
	Jazz Waltz 4	Guitar Swing	Modern R&B	Flamenco				
	Modern Waltz	POPS		Pop Flamenco				
1	Pop Waltz	8Beat Light 1	Gospel Shuffle	Pasodoble				
	Country Waltz	8Beat Light 2	Gospel Sisters	Polka 1				
	SWING&JAZZ		8Beat Light 3	Amazing Gospel	1	Polka 2		
	1	Big Band 1	8Beat Light 4	6/8 Blues		Banda Polka		
		Big Band 2	Folk Rock 1	Slow Blues		Irish Dance		
Big Band 3		Folk Rock 2	6/8 Soul	Tarantella				
Big Band 4		60's 8Beat	Blues Shuffle	Sirtaki				
Big Band 5		Asian Pops	LATIN		Enka			
Big Band 6		Unplugged 1	Samba	Reggae				
Big Band 7		Unplugged 2	Big Band Samba	Happy Reggae				
Big Band Bop		Unplugged 3	Light Samba 1	Sheriff Reggae				
Orch. Big Band		8Beat Adria	Light Samba 2	Shuffle Reggae				
Orchestra Swing		Bubblegum Pop	Pop Samba 1	Bluegrass 1				
Movie Panther	70's 8Beat	Pop Samba 2	Bluegrass 2					
Jungle Drum	Tijuana	1	Hoedown					
2	Jazz Club		SingerSongWriter	Country 2/4				
	Simple Swing		Surfin' 8Beat	Country Shuffle				
	Acoustic Jazz		Finger Pickin'	Country Band				
Medium Jazz	Heart Beat		Guitar Pop	Hawaiian				
	Guitar Pop		Mexican Dance					

BALLAD		
1	Power Ballad	
	Dramatic Ballad	
	Movie Ballad 1	
	Movie Ballad 2	
	Secret Service	
	Carpenters Pop	
	Romantic Ballad	
	Love Song	
	16Beat Ballad 1	
	16Beat Ballad 2	
	16Beat Ballad 3	
	Easy Ballad	
	2	Guitar Ballad 1
Guitar Ballad 2		
Guitar Ballad 3		
Organ Ballad		
Chart Ballad		
Analog Ballad		
Pop Ballad		
8Beat Modern		
Chillout		
Slow&Easy		
3		6/8 Slow Rock 1
		6/8 Slow Rock 2
		6/8 Orchestra 1
	6/8 Orchestra 2	
	6/8 Ballad	
	Acoustic Ballad	
ROCK		
1	Power Rock	
	Southern Rock	
	60's Rock 1	
	60's Rock 2	
	Hard Rock 1	
	Hard Rock 2	
	Rock Shuffle 1	
	Rock Shuffle 2	
	Tears Rock 1	
	Tears Rock 2	
	Soft Rock	
	British Rock	
	2	Country Rock 1
Country Rock 2		
New Country		
Cowboy Rock		
Rock&Roll 1		
Rock&Roll 2		
Skiffle		
Caribbean Rock		
R&R Shuffle		
Jive		
Boogie Woogie		

DANCE		
1	Ibiza 1	
	Ibiza 2	
	Euro Trance	
	Disco Teens	
	Techno Party	
	Club Dance	
	Dream Dance	
	Club House	
	UK Pop	
	US Disco	
	Swing House	
	2	US Pop
		US Hip Hop
Classic Hip Hop		
Trip Hop		
Chart Pop		
Ground Beat		
Hip Hop Groove		
Hip Hop Pop		
Hip Hop Light		
Euro Hip Hop		
3		Latin DJ's
		Club Latin
		Latin Disco 1
	Latin Disco 2	
	Garage	
	6/8 Trance	
	80's Dance	
	Pop Beat 1	
	Pop Beat 2	
	Funky Dance	
	4	Disco Philly 1
		Disco Philly 2
		70's Disco 1
70's Disco 2		
Disco Funk		
Disco Chocolate		
Dance Pop		

Certain rhythms created for use with slow, soft Songs or for Songs that do not use a bass part at the beginning, may not have drum sections. To use these rhythms, refer to the following information.

Some sections of the following nine rhythms are configured with accompaniment only; they do not contain any drum or percussion.

Category	Rhythm	Section
MARCH	6/8 Organ March	Main A, Main B
	Baroque	All sections except Intro 1
WALTZ	Simple Waltz	Ending 1
	Guitar Serenade	All sections except Intro 1
WORLD MUSIC	Banda Polka	Main A, Fill In A
	Hoedown	Ending 1
	Mexican Dance	Main A, Fill In A
BALLAD	Dramatic Ballad	Main A
ROCK	R&R Shuffle	Ending 1

Some sections of the following five rhythms do not contain an Auto Bass part. This means that even though the Auto Bass Chord is turned on, the bass part will not sound.

- Guitar Serenade in the WALTZ category
- Folk Rock 1 in the POPS category
- Unplugged 1 in the POPS category
- Pop Flamenco in WORLD MUSIC category
- New Country in the ROCK category

4 Accompaniment

The Accompaniment function provides arpeggiated chords and other instrumental embellishments when rhythms are used.

Accompaniment controls are selected from the Rhythm Menu and Rhythm Condition display.

1 Press any one of the RHYTHM buttons once.

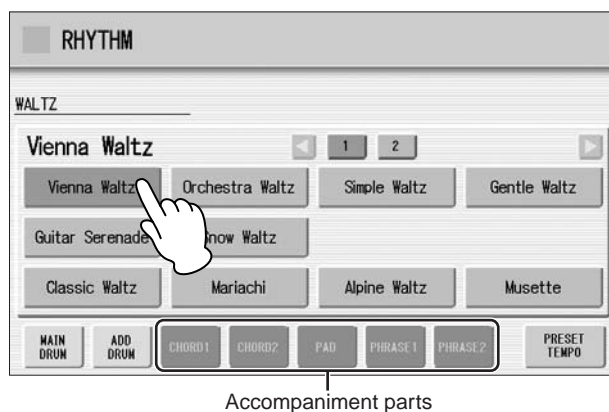

At the bottom of the display, there are seven part buttons, such as Chord 1, Chord 2, Pad, and so on. These parts, with the exception of Main Drum and Add Drum, are Accompaniment parts.

2 Turn the desired parts on.

The Accompaniment consists of five parts, Chord 1, Chord 2, Pad, Phrase 1, and Phrase 2, and each of them can be set to on or off by pressing corresponding button in the display.

If you turn all the parts off, the Accompaniment does not sound.

CHORD 1/CHORD 2:

These are the rhythmic chord backing parts.

PAD:

This part features sustained chords and commonly uses lush sounds such as strings and organ.

PHRASE 1/PHRASE 2:

These parts are used for various embellishments and riffs that enhance the song, such as brass section accents and chord arpeggios.

Not all parts contain accompaniment data. Some parts may be empty depending on the selected rhythm and rhythm section.

Main Drum and Add Drum contains the drum and percussion rhythm patterns. When you turn both Main Drum and Add Drum off, the drum and percussion do not sound. Generally, Main Drum contains the main part of the rhythm and Add drum has additional percussion sounds, such as tambourine.

3 Adjust the volume and amount of reverb applied to the Accompaniment.

Pressing the same rhythm button on the panel again calls up the Rhythm Condition display.

The two sliders at the right side of the display can control the Accompaniment volume and reverb. Touch the slider in the display or use the Data Control dial to adjust the volume/reverb.

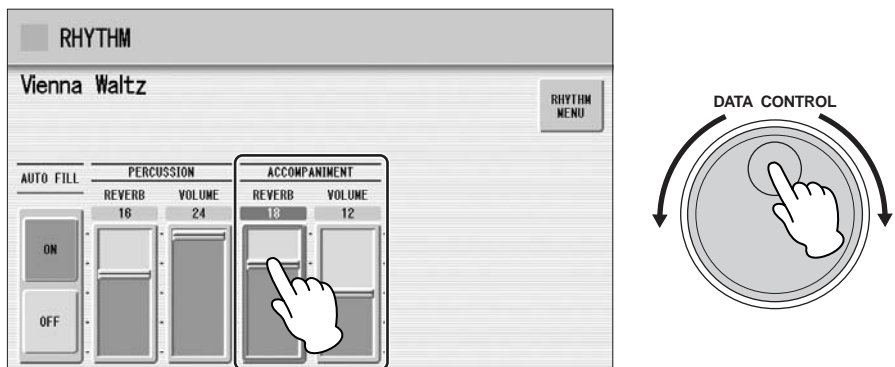

5 Automatic Accompaniment – Auto Bass Chord (A.B.C.)

The Auto Bass Chord (A.B.C.) function works with the Rhythm section of the Electone to automatically produce bass accompaniment as you play. It adds an entirely new dimension to your performance by effectively putting a full backing band at your disposal. There are three modes used for producing Automatic Accompaniment patterns.

Before using the A.B.C. function, turn Pedal Poly off. If Pedal Poly is set to on, the bass pattern of the A.B.C. will not sound.

 **Reference Page**
POLY (page 40)

To set the A.B.C. function:

Press the [A.B.C./M.O.C.] button.

A.B.C./M.O.C. Display

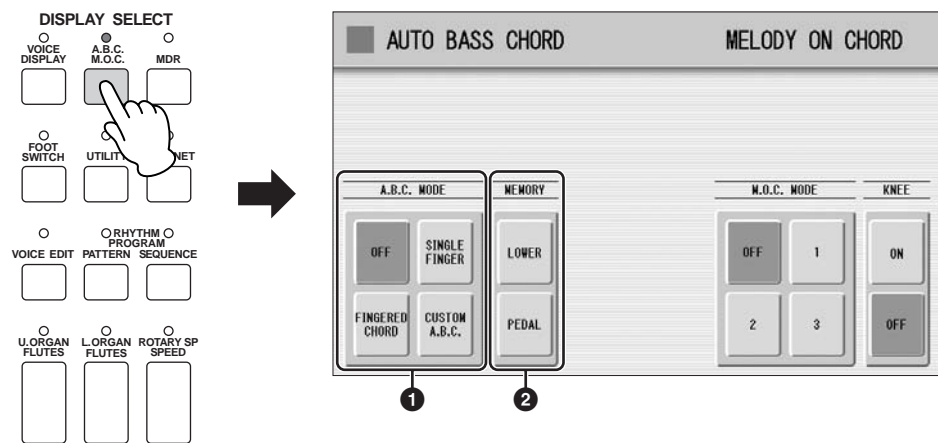

The A.B.C./M.O.C. display appears. The A.B.C. section is at the left half of this display.

1 A.B.C. MODE

OFF:

Cancels the Auto Bass Chord function.

SINGLE FINGER:

The Single Finger mode provides the fastest and easiest means to obtain many different chord/bass combinations. You can produce major, minor, 7th, and minor 7th chords by simply using one, or at most, two or three fingers to play the chords. The chord produced will sound in the same octave regardless of where it is played on the Lower keyboard.

C Key of C



Major chords:

Press the root of the chord (the note that corresponds to the chord's name).



Minor chords:

Simultaneously press the root and any one black key to the left of it.



7th chords:

Simultaneously press the root and any one white key to the left of it.



Minor 7th chords:

Simultaneously press the root as well as any black key and any white key to the left of it.

Playing single finger chords without the use of the rhythm lets you add full continuous chords to your performance.

FINGERED CHORD:

The Fingered Chord mode automatically produces bass accompaniment for chords played in the Lower keyboard. It allows you to use a wider range of chord types than in the Single Finger mode. In the Fingered Chord mode, you play full chords while the Auto Bass Chord function automatically selects the appropriate bass pattern. If you play only one or two notes in the Lower keyboard, the appropriate chord will sound on the basis of the previously played chord.

Key of C

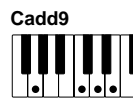
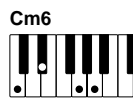
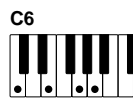
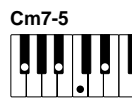
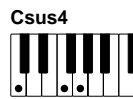
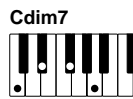
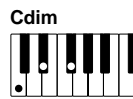
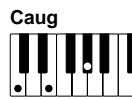
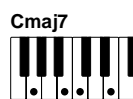
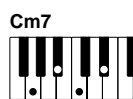
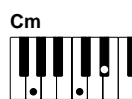

NOTE

When playing certain chords (aug, dim7, sus4, 6, and m6), make sure to play the root of the chord as the lowest note in that chord.

Playing fingered chords without the use of the rhythm lets you add full continuous chords to your performance.

CUSTOM A.B.C.:

The Custom A.B.C. mode is a slight variation on the Fingered Chord mode. It allows you to determine what bass notes will be played in the accompaniment by playing a note on the Pedalboard along with the chords you play in the Lower keyboard.

2 MEMORY

LOWER:

When this is set to on, the Lower keyboard Voices and chord accompaniment keep playing even after you release your fingers from the Lower keyboard, while the rhythm plays.

PEDAL:

When this is set to on, the Pedalboard Voices and bass accompaniment keep playing even after you release your foot from the Pedalboard, while the rhythm plays.

(In the Single Finger and Fingered modes:) When this is set to on, the bass accompaniment of the Pedalboard Voices keeps playing even after you release your fingers from the Lower keyboard.

When you start the rhythm with [SYNCHRO START] button, set the Lower/Pedal Memory to on. When Memory is off, releasing your fingers from Lower keyboard stops the rhythm.

6 Melody On Chord (M.O.C.)

The Melody On Chord (M.O.C.) feature automatically adds a harmony part to the melodies you play on the Upper keyboard. The harmony is derived from the chords you play on the Lower keyboard – or from the chords that are played for you, if you use Automatic Accompaniment. Melody On Chord has three different modes, each providing a different set of harmonics to accompany the melody played. Melody On Chord can also be controlled with the Knee Lever.

To set the M.O.C. function:

Press the [A.B.C./M.O.C.] button.

A.B.C./M.O.C. Display

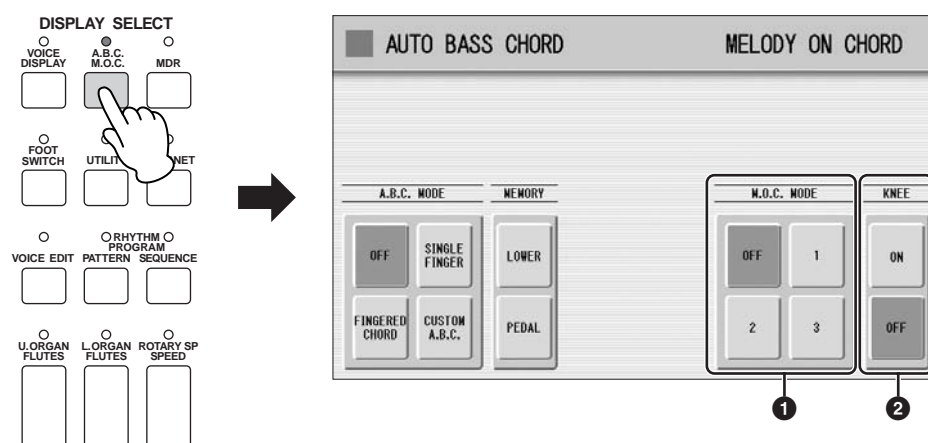

The A.B.C./M.O.C. display appears. The M.O.C. section is at the right half of this display.

1 M.O.C. MODE

OFF:

Cancels the Melody On Chord function.

Mode 1:

Produces harmonies of up to two notes in a range close to the melody played.

Mode 2:

Produces harmonies of up to three notes in a range close to the melody played.

Mode 3:

Produces harmonies of up to four notes in a range relatively distant from the melody played.

2 KNEE

On/off switch for Knee Lever control over Melody On Chord operation. To use the Melody On Chord function with Knee Lever control, first switch the Knee setting to ON, then select one of the three modes (described above). When the control is on, pressing the Knee Lever to the right activates the Melody On Chord function.

Melody On Chord can be heard only when the Upper Keyboard Voice section's volume is set to the appropriate value. Melody On Chord does not apply to the Lead Voices.



Reference Page

Controlling Melody On Chord (with Knee Lever); (page 189)

7 Keyboard Percussion

The Keyboard Percussion function features many types of drum and percussion sounds, playable from the keyboards and Pedalboard.

Keyboard Percussion has two different modes, Preset and User. Preset Keyboard Percussion lets you play the preset drum kit sounds from the keyboards (assigned beforehand to the keys), while the User Keyboard Percussion lets you freely assign the drum sounds to any key or pedal you wish.

Using the Preset Keyboard Percussion

- 1 Turn off the Upper, Lower and/or Pedal Voices by setting each Voice's volume to MIN.
- 2 Turn on the Keyboard Percussion function by pressing the **KEYBOARD PERCUSSION [1]** or **[2]** button.

The Keyboard Percussion (K.B.P.) Display appears.



NOTE

In the Voice Display, each Voice section can be muted (page 18).

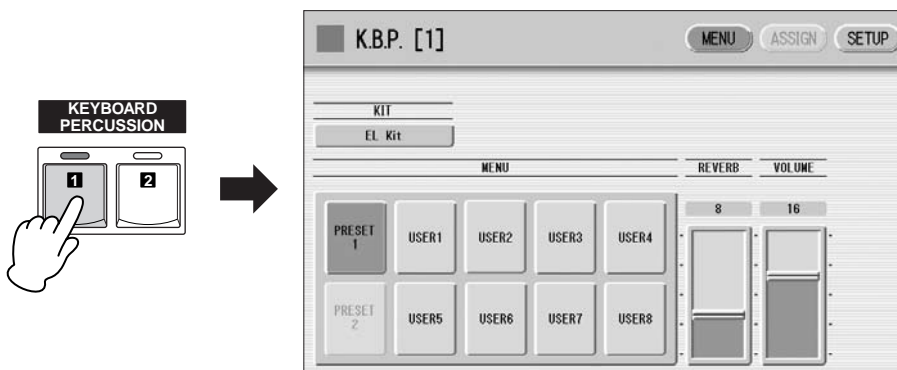

NOTE

Two Keyboard Percussion sets, [1] and [2], can be played at the same time by setting both buttons to on.

Pressing the KEYBOARD PERCUSSION [1] button calls up the Preset 1 kit on the Upper/Lower keyboards, and pressing [2] button calls up the Preset 2 kit on the Pedalboard.



NOTE
Percussion Kit selection is common for the Keyboard Percussion function. For example, if you select "Standard Kit 1" for Preset 1 of the Keyboard Percussion, the kit for Preset 2 and User 1-8 will also be changed to "Standard Kit 1."

3 Select the desired percussion kit.

As a default, EL Kit is assigned to the keyboards but you can change the kit from a total of 16 different kits. Pressing the Kit button on the display calls up the Percussion Kit List. Choose the desired Kit from the list.

To abort the operation, press the [CLOSE] button.

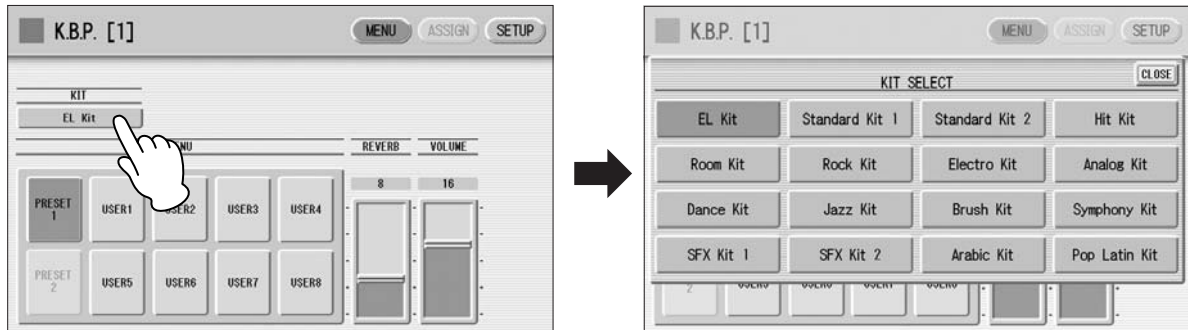

For details of percussion assignments for each kit, see the Preset Keyboard Percussion List on page 67.

The message "Are you sure you want to clear all assignments and setup data?" may appear when you change the kit. Select [CLEAR] to clear all assignments (made in the ASSIGN Page) and detailed settings (made in the SETUP Page) and call up the selected kit on the panel. Select [CANCEL] to call up the selected kit without erasing the assignments and detailed settings.

4 Adjust the volume and amount of reverb applied to the Keyboard Percussion.

Two sliders in the K.B.P. display determine the reverb and volume settings.

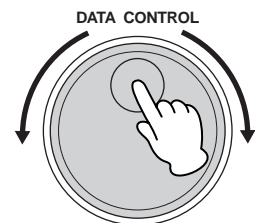
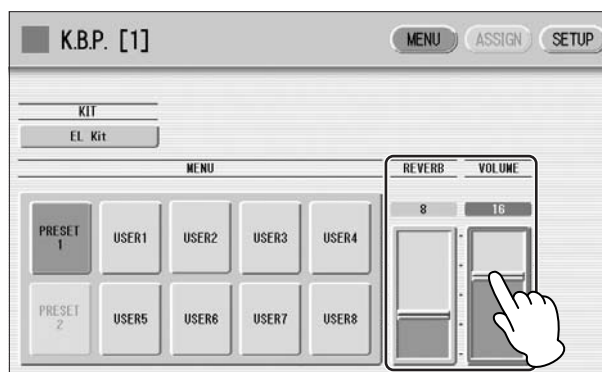

The settings here determine the reverb/volume for the entire Keyboard Percussion setup, not for each percussion instrument. You can, however, adjust each percussion instrument's reverb/volume (page 74).

5 Play some notes on the keyboards and/or Pedalboard.

Preset Keyboard Percussion List

		EL Kit			Standard Kit 1*		
		Preset 2 (PK)	Preset 1 (LK)	Preset 1 (UK)	Preset 2 (PK)	Preset 1 (LK)	Preset 1 (UK)
C1		Bass Drum Heavy	-		Kick	-	
	C#1	SD Brush Roll	-		Side Stick	Surdo Mute	
D1		Snare Drum Heavy	-		Snare	Surdo Open	
	D#1	SD Brush Shot 1	Claves		Hand Clap	Hi Q	
E1		SD Reverb 1	-		Snare Tight	Whip Slap	
F1		Snare Drum Light	-		Floor Tom L	Scratch H	
	F#1	Tom 3	Synth Tom 3		Hi-Hat Closed	Scratch L	
G1		Snare Drum Rim 1	Concert BD		Floor Tom H	Finger Snap	
	G#1	Tom 2	Synth Tom 2		Hi-Hat Pedal	Click Noise	
A1		Hi-Hat Close	Bass Drum Heavy		Low Tom	Metronome Click	
	A#1	Tom 1	Synth Tom 1		Hi-Hat Open	Metronome Bell	
B1		Hi-Hat Open	Bass Drum Light		Mid Tom L	Seq Click L	
C2		Ride Cymbal 1	Snare Drum Heavy	-	Mid Tom H	Seq Click H	-
	C#2	Synth Tom 3	SD Brush Roll	-	Crash Cymbal 1	Brush Tap	-
D2		Crash Cymbal 1	Snare Drum Heavy	-	High Tom	Brush Swirl	-
	D#2	Synth Tom 2	SD Brush Shot 1	-	Ride Cymbal 1	Brush Slap	-
E2		Orchestra Cymbal	SD Reverb 1	-	Chinese Cymbal	Brush Tap Swirl	-
F2		-	Snare Drum Light	-	Ride Cymbal Cup	Snare Roll	-
	F#2	Synth Tom 1	Tom 3	-	Tambourine	Castanet	-
G2		-	Snare Drum Rim 1	-	Splash Cymbal	Snare Soft	-
	G#2		Tom 2	-		Sticks	-
A2			Hi-Hat Close	-		Kick Soft	-
	A#2		Tom 1	-		Open Rim Shot	-
B2			Hi-Hat Open	-		Kick Tight	-
C3			Ride Cymbal 1	-		Kick	Bongo H
	C#3		Orch Snare Drum	-		Side Stick	Bongo L
D3			Crash Cymbal 1	-		Snare	Conga H Mute
	D#3		Snare Drum Roll	-		Hand Clap	Conga H Open
E3			Orchestra Cymbal	-		Snare Tight	Conga L
F3			Orch Cymbal Roll	-		Floor Tom L	Timbale H
	F#3		Triangle Mute	-		Hi-Hat Closed	Timbale L
G3			Tambourine	-		Floor Tom H	Agogo H
	G#3		Triangle Open	-		Hi-Hat Pedal	Agogo L
A3			Castanet	-		Low Tom	Cabasa
	A#3		Cowbell 1	-		Hi-Hat Open	Maracas
B3			Timbale 1 Low	-		Mid Tom L	Samba Whistle H
C4			Timbale 1 High	-		Mid Tom H	Samba Whistle L
D4			Wood Block Low	-		Crash Cymbal 1	Guiro Short
	D#4		Conga Low	-		High Tom	Guiro Long
E4			Wood Block High	-		Ride Cymbal 1	Claves
F4			Conga High	-		Chinese Cymbal	Wood Block H
	F#4		Bongo Low	-		Ride Cymbal Cup	Wood Block L
G4			Agogo Low	-		Tambourine	Cuica Mute
	G#4		Bongo High	-		Splash Cymbal	Cuica Open
A4			Agogo High	-		Cowbell	Triangle Mute
	A#4		Cuica Low	-		Crash Cymbal 2	Triangle Open
B4			Hand Claps	-		Vibraslap	Shaker
B5			Cuica High	-		Ride Cymbal 2	Jingle Bells
C5			Shaker	-		-	Bell Tree
D5				-			-
E5				-			-
F5				-			-
G5				-			-
A5				-			-
B5				-			-
C6				-			-

⬜ : Indicates the keys of the ELS-01/01C keyboard.

*The 10 kits, Standard Kit 2 – Symphony Kit, have the same sound assignments as Standard Kit 1.

		SFX Kit 1			SFX Kit 2		
		Preset 2 (PK)	Preset 1 (LK)	Preset 1 (UK)	Preset 2 (PK)	Preset 1 (LK)	Preset 1 (UK)
C1	C#1	Cutting Noise 1	-		Phone Call	-	
D1		Cutting Noise 2	-		Door Squeak	-	
E1	D#1	-	-		Door Slam	-	
F1		String Slap	-		Scratch Cut	-	
G1	F#1	-	-		Scratch H 3	-	
A1	G#1	-	-		Wind Chime	-	
B1	A#1	-	-		Telephone Ring	-	
C2		-	-		-	-	
D2	C#2	-	-		-	-	
E2	D#2	-	-		-	-	
F2	F#2	Flute Key Click	-		CarEngnIgnition	-	
G2	G#2	-	-		Car Tires Squeal	-	
A2	A#2	-	-		Car Passing	-	
B2		-	-		Car Crash	-	
C3	C#3	-	-		-	-	
D3	D#3	-	-		-	-	
E3		Cutting Noise 1	-		Phone Call	Burst	
F3	F#3	Cutting Noise 2	-		Door Squeak	Roller Coaster	
G3	G#3	-	-		Door Slam	Submarine	
A3	A#3	String Slap	-		Scratch Cut	-	
B3		-	-		Scratch H 3	-	
C4	C#4	-	-		Wind Chime	-	
D4	D#4	-	-		Telephone Ring	-	
E4		-	-		-	-	
F4	F#4	-	Shower		-	Laugh	
G4	G#4	-	Thunder		-	Scream	
A4	A#4	-	Wind		-	Punch	
B4		-	Stream		-	Heart Beat	
C5	C#5	-	Bubble		-	Foot Steps	
D5	D#5	-	Feed		-	-	
E5		-	-		-	-	
F5	F#5	Flute Key Click	-		CarEngnIgnition	-	
G5	G#5	-	-		Car Tires Squeal	-	
A5	A#5	-	-		Car Passing	-	
B5		-	-		Car Crash	-	
C6		-	-		Siren	-	
		-	-		Train	-	
		-	-		Jet Plane	-	
		-	-		Starship	-	
		-	Dog		-	Machine Gun	
		-	Horse		-	Laser Gun	
		-	Bird Tweet		-	Explosion	
		-	-		-	Firework	
		-	-		-	-	
		-	-		-	-	
		-	Ghost		-	-	
		-	Maou		-	-	
		-	-		-	-	
		-	-		-	-	
		-	-		-	-	
		-	-		-	-	
		-	-		-	-	

		Arabic Kit			Pop Latin Kit		
		Preset 2(PK)	Preset 1 (LK)	Preset 1 (UK)	Preset 2 (PK)	Preset 1 (LK)	Preset 1 (UK)
C1	C#1	Kick Soft	-		Bongo H Open 1 f	-	
D1	D#1	Side Stick	-		Bongo H Open 3 f	-	
E1		Snare Soft	-		Bongo H Rim	-	
F1	F#1	Arabic Hand Clap	-		Bongo H Tip	-	
G1	G#1	Snare Drum	-		Bongo H Heel	-	
A1	A#1	Floor Tom L	-		Bongo H Slap	-	
B1		Hi-Hat Closed	-		Bongo L Open 1 f	Hand Clap	
C2	C#2	Floor Tom H	-		Bongo L Open 3 f	-	
D2	D#2	Hi-Hat Pedal	-		Bongo L Rim	-	
E2		Low Tom	-		Bongo L Tip	-	
F2	F#2	Hi-Hat Open	-		Bongo L Heel	Conga H Tip	
G2	G#2	Mid Tom L	-		Bongo L Slap	Conga H Heel	
A2	A#2	Mid Tom H	Nakarazan Dom	-	Timbale L Open	Conga H Open	-
B2		Crash Cymbal 1	Cabasa	-	-	Conga H Mute	-
C3	C#3	High Tom	Nakarazan Edge	-	-	Conga H SlapOpen	-
D3	D#3	Ride Cymbal 1	Hager Dom	-	-	Conga H Slap	-
E3		Crash Cymbal 2	Hager Edge	-	-	Conga H SlapMute	-
F3	F#3	Duhulla Dom	Bongo H	-	Paila L	Conga L Tip	-
G3	G#3	Tambourine	Bongo L	-	Timbale H Open	Conga L Heel	-
A3	A#3	Duhulla Tak	Conga H Mute	-	-	Conga L Open	-
B3			Conga H Open	-		Conga L Mute	-
C4	C#4		Conga L	-		Conga L SlapOpen	-
D4	D#4		Zagrouda H	-		Conga L Slap	-
E4			Zagrouda L	-		Conga L Slide	-
F4	F#4		Kick Soft	Katem Dom		Bongo H Open 1 f	Cowbell Top
G4	G#4		Side Stick	Katem Tak		Bongo H Open 3 f	-
A4	A#4		Snare Soft	Katem Sak		Bongo H Rim	-
B4			Arabic Hand Clap	Katem Tak		Bongo H Tip	-
C5	C#5		Snare Drum	Doff Tak		Bongo H Heel	Guiro Short
D5	D#5		Floor Tom L	Tabla Dom		Bongo H Slap	Guiro Long
E5			Hi-Hat Closed	Tabla Tak 1		Bongo L Open 1 f	-
F5	F#5		Floor Tom H	Tabla Tik		Bongo L Open 3 f	-
G5	G#5		Hi-Hat Pedal	Tabla Tak 2		Bongo L Rim	Tambourine
A5	A#5		Low Tom	Tabla Sak		Bongo L Tip	-
B5			Hi-Hat Open	Tabla Roll Edge		Bongo L Heel	-
C6			Mid Tom L	Tabla Flam		Bongo L Slap	-
D6			Mid Tom H	Sagat 1		Timbale L Open	Maracas
E6			Crash Cymbal 1	Tabel Dom		-	Shaker
F6			High Tom	Sagat 3		-	Cabasa
G6			Ride Cymbal 1	Tabel Tak		-	Cuica Mute
A6			Crash Cymbal 2	Sagat 2		-	Cuica Open
B6			Duhulla Dom	Rik Dom		Paila L	-
C7	C#7		Tambourine	Rik Tak 2		Timbale H Open	-
D7	D#7		Duhulla Tak	Rik Finger 1		-	-
E7			Cowbell	Rik Tak 1		-	-
F7	F#7		Duhulla Sak	Rik Finger 2		-	Triangle Mute
G7	G#7		Claves	Rik BrassTremolo		-	Triangle Open
A7	A#7		Doff Dom	Rik Sak		Paila H	-
B7			-	Rik Tik		-	Wind Chime
C8	C#8						
D8	D#8						
E8							
F8	F#8						
G8	G#8						
A8	A#8						
B8							
C9	C#9						
D9	D#9						
E9							
F9	F#9						
G9	G#9						
A9	A#9						
B9							
C10	C#10						
D10	D#10						
E10							
F10	F#10						
G10	G#10						
A10	A#10						
B10							
C11	C#11						
D11	D#11						
E11							
F11	F#11						
G11	G#11						
A11	A#11						
B11							
C12	C#12						
D12	D#12						
E12							
F12	F#12						
G12	G#12						
A12	A#12						
B12							

Assigning sounds to the User Keyboard Percussion

You can assign any desired drum and percussion sound to any key or pedal, and your original setups can be saved to eight memory locations: User 1 through User 8. The User setting saved in User memory location can be called up by using the KEYBOARD PERCUSSION [1] or [2] buttons.

In the instructions below, drum sounds are assigned to User 1 and called up with KEYBOARD PERCUSSION [1] button.

1 Turn on the Keyboard Percussion function by pressing the KEYBOARD PERCUSSION [1] button.

The K.B.P. display appears.

2 Press [USER 1] on the display.

This procedure assigns User 1 to the KEYBOARD PERCUSSION [1] button. You can call up the User 1 setting the next time you press the [1] button.

3 Select the desired percussion kit.

See page 66 for selecting the kit.

4 Press the [ASSIGN] button at the top right of the display to call up the ASSIGN Page.

In the ASSIGN Page, you can assign specific drum sounds to any of the keys.



Reference Page

Kit Assign List (page 76)

5 Select the desired drum instrument that you wish to assign to a key.

Select the desired drum instrument category with the category buttons in the display. The drum instrument menu of the selected category appears.

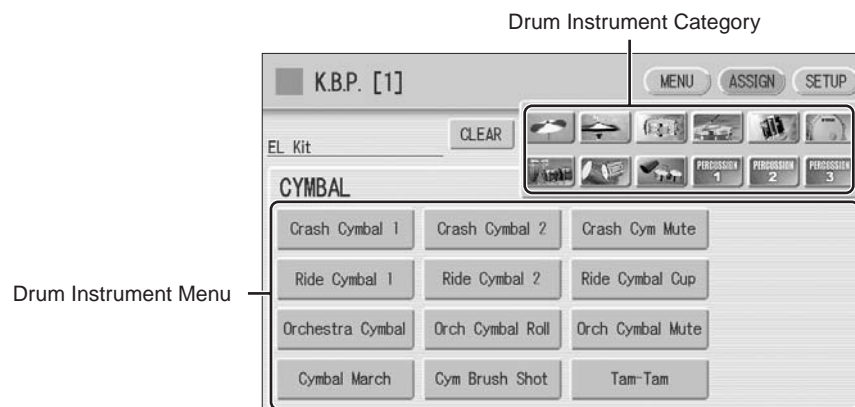

6 Assign an instrument to a particular key or pedal by simultaneously holding down the desired instrument name in the display and pressing the key (or pedal) to which the instrument is to be assigned.

The key to which the instrument is to be assigned

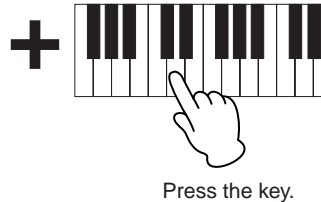
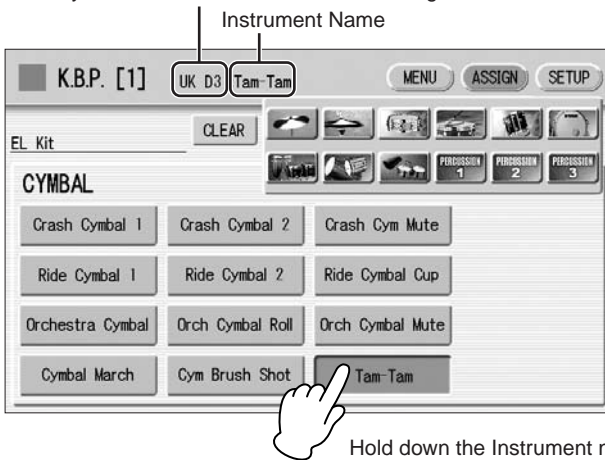

NOTE

Though eight User Keyboard Percussion setups can be created, they cannot be memorized to Registration Memory. Only on/off data and the Keyboard Percussion Menu are memorized to Registration Memory.

When the assignment is complete, the key name and instrument name is displayed at the top of the display. The assignments are saved to the User memory selected in Step 2 (in this example, User 1).

7 Repeat the operation steps above as necessary to construct your own User Keyboard Percussion set.

To erase one instrument:

Simultaneously hold down the [CLEAR] button in the display (ASSIGN Page) and press the key (or pedal) corresponding to the instrument you wish to erase.

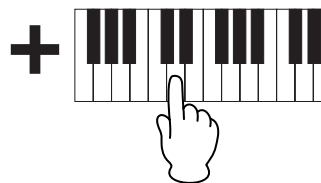

The Keyboard Percussion setting you have created is automatically saved when you switch to another display. While data is being saved, the square at the top left of the display turns light blue for a few seconds. Do not turn the power off while the Keyboard Percussion settings are being saved.

To erase all instruments:

You can clear all assignments using the [CLEAR] button in the display (ASSIGN Page).

- 1 Press, then release the [CLEAR] button. The following display appears, prompting confirmation of the operation.

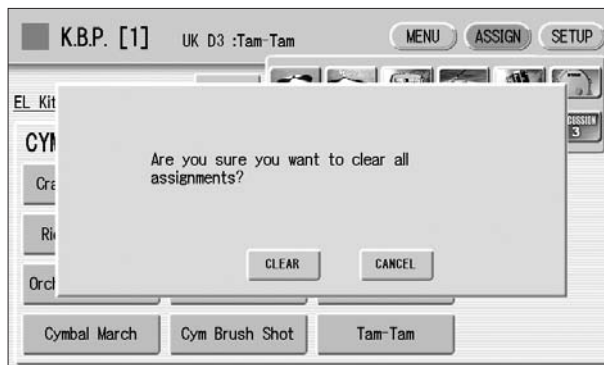

- 2 Press [CLEAR] in the display to erase all data. When [CLEAR] is selected, a “Completed” message momentarily appears on the display.

Press [CANCEL] in the display to abort the operation.

Copying the Keyboard Percussion settings

You can copy the Preset Keyboard Percussion to one of the User locations, or copy from one User location to another. In the instructions below, Preset 1 is copied to User 1.

- 1 Press the **KEYBOARD PERCUSSION [1]** button to copy Preset 1. To copy Preset 1, select the [1] button; to copy Preset 2, select the [2] button. To copy either User location, select button [1] or [2].
- 2 Within the Menu buttons, select the User location as the destination — for example, User 1.

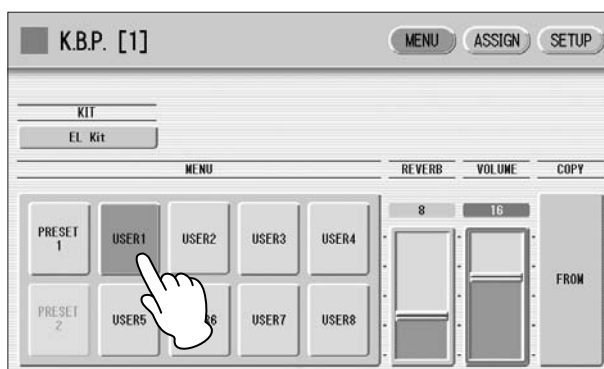

- 3** Press the **COPY [FROM]** button in the display. A list appears, letting you select the copy source location.

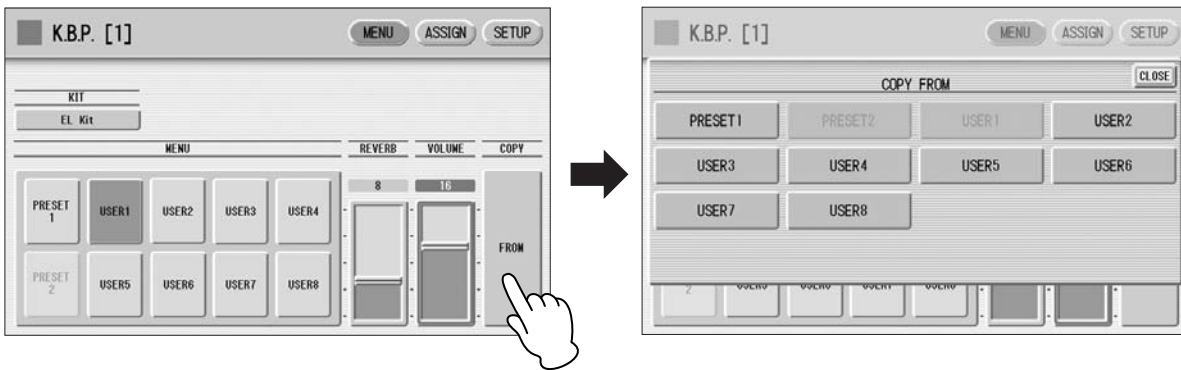

- 4** Select the copy source (**Preset 1 here**) from the list.
A message appears, prompting confirmation of the operation.
- 5** Press the **[COPY]** button in the display to copy **Preset 1**. When **[COPY]** is selected, a “Completed” message momentarily appears in the display.
Press the **[CANCEL]** button in the display to abort the operation.

Detailed settings for each percussion instrument

You can independently adjust the settings of pan, pitch, reverb and volume for each instrument. The settings here are system settings that cannot be memorized to Registration memory.

- 1 Turn off the volume of the relevant keyboard (the keyboard to which the instrument to be changed is assigned).**
- 2 Press the [SETUP] button at the top right of the K.B.P. display to call up the SETUP Page.**
- 3 Press the appropriate key (the key to which the instrument to be changed is assigned).**

The selected instrument's name is shown on the display and you can change its settings.

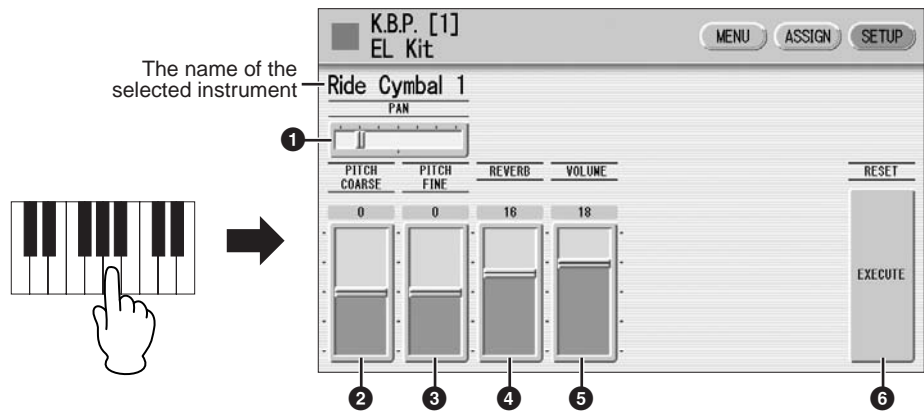

1 PAN

Determines the position of the currently selected instrument in the stereo image. Seven pan positions are available.

2 PITCH COARSE

Adjusts the pitch of the currently selected instrument by 100 cents.

Range: -64 – +63

3 PITCH FINE

Adjusts the pitch of the currently selected instrument by one cent, allowing more detailed tuning of the instrument than PITCH COARSE (2).

Range: -64 – +63

4 REVERB

Determines the amount of reverb applied to the currently selected instrument.

Range: 0 – 24

5 VOLUME

Determines the volume of the currently selected instrument.

Range: 0 – 24

6 RESET

Initializes settings such as pan, pitch, and reverb to their default values. Pressing the [EXECUTE] button calls up the following display, prompting confirmation of the operation.



Press the [EXECUTE] button in the display to restore (initialize) the default settings. When [EXECUTE] is selected, a “Complete” message momentarily appears on the display.

Press the [CANCEL] button in the display to abort the operation.

Kit Assign List

5
Rhythm/Keyboard Percussion

EL Kit
CYMBAL
Crash Cymbal 1
Crash Cymbal 2
Crash Cym Mute
Ride Cymbal 1
Ride Cymbal 2
Ride Cymbal Cup
Orchestra Cymbal
Orch Cymbal Roll
Orch Cymbal Mute
Cymbal March
Cym Brush Shot
Tam-Tam
HI-HAT
Hi-Hat Open
Hi-Hat Close
Hi-Hat Pedal 1
Hi-Hat Pedal 2
Analog HH Open
Analog HH Close
SNARE DRUM
Snare Drum Light
Snare Drum Heavy
Snare Drum Rim 1
Snare Drum Rim 2
SD Accent 1
SD Accent 2
SD Reverb 1
SD Reverb 2
Synth Snare Drum
Orch Snare Drum
Snare Drum Roll
Analog SD
SNARE BRUSH
SD Brush Shot 1
SD Brush Shot 2
SD Brush Roll
TOM
Tom 1
Tom 2
Tom 3
Tom 4
Tom Brush Shot 1
Tom Brush Shot 2
Tom Brush Shot 3
Tom Brush Shot 4
Synth Tom 1
Synth Tom 2
Synth Tom 3
BASS DRUM
Bass Drum Light
Bass Drum Heavy
Bass Drum Attack
Synth Bass Drum
Bass Drum March
Concert BD
Analog BD Short
Analog BD Long
CONGA/BONGO
Conga High
Conga Low
Conga Slap
Conga Muff
Conga Slide
Bongo High
Bongo Low
Bongo Slap
Bongo Mute
CUICA/SURDO
Cuica High
Cuica Middle
Cuica Low
Tamborim Open
Tamborim Mute
Surdo Open
Surdo Mute
Surdo Rim
Surdo Muff
TIMBALES/COWBELL
Timbale 1 High

Timbale 1 Low
Timbale 2 High
Timbale 2 Low
Timbale 3 High
Timbale 3 Low
Timbale 4 High
Timbale 4 Low
Cowbell 1
Cowbell 2
Cowbell 3
Cowbell 4
PERCUSSION 1
Cabasa
Shaker
Maracas High
Maracas Low
Guiro Short
Guiro Long
Woodblock High
Woodblock Mid
Woodblock Low
Claves
Castanet
Vibraslap
PERCUSSION 2
Agogo High
Agogo Low
Triangle Open
Triangle Mute
Windbell Down
Windbell Up
Tambourine
Pandeiro
Bells
Hand Claps
Finger Snap
Scratch
Noise Percussion
PERCUSSION 3
Kotsuzumi 1
Kotsuzumi 2
Kotsuzumi 3
Kotsuzumi 4
Ohtsuzumi 1
Ohtsuzumi 2
Taiko 1
Taiko 2
Ohdaiko 1
Ohdaiko 2
Kakegoe 1
Kakegoe 2
Kakegoe 3

Standard Kit 1
CYMBAL
Crash Cymbal 1
Crash Cymbal 2
Splash Cymbal
Chinese Cymbal
Ride Cymbal 1
Ride Cymbal 2
Ride Cymbal Cup
Hi-Hat Open
Hi-Hat Closed
Hi-Hat Pedal
SNARE DRUM
Snare
Snare Tight
Snare Soft
Snare Roll
Side Stick
Open Rim Shot
Brush Tap
Brush Slap
Brush Swirl
Brush Tap Swirl
TOM
Floor Tom L
Floor Tom H
Low Tom
Mid Tom L

Mid Tom H
High Tom
BASS DRUM
Kick
Kick Tight
Kick Soft
PERCUSSION 1
Conga H Open
Conga L
Conga H Mute
Bongo H
Bongo L
Timbale H
Timbale L
Cowbell
Claves
Guiro Long
Guiro Short
Maracas
Vibraslap
PERCUSSION 2
Surdo Mute
Surdo Open
Cuica Mute
Cuica Open
Cabasa
Shaker
Agogo H
Agogo L
Samba Whistle H
Samba Whistle L
PERCUSSION 3
Tambourine
Castanet
Jingle Bells
Bell Tree
Triangle Open
Triangle Mute
Wood Block H
Wood Block L
Sticks
Whip Slap
Finger Snap
Hand Clap
PERCUSSION 4
Hi Q
Click Noise
Scratch H
Scratch L
Seq Click L
Seq Click H
Metronome Click
Metronome Bell

Standard Kit 2
CYMBAL
Crash Cymbal 1
Crash Cymbal 2
Splash Cymbal
Chinese Cymbal
Ride Cymbal 1
Ride Cymbal 2
Ride Cymbal Cup
Hi-Hat Open
Hi-Hat Closed
Hi-Hat Pedal
SNARE DRUM
Snare Short
Snare Tight H
Snare Soft 2
Snare Roll
Side Stick Light
Open Rim Shot H
Brush Tap
Brush Slap
Brush Swirl
Brush Tap Swirl
TOM
Floor Tom L
Floor Tom H
Low Tom

Mid Tom L
Mid Tom H
High Tom
BASS DRUM
Kick Short
Kick Tight
Kick Soft
PERCUSSION 1
Conga H Open
Conga L
Conga H Mute
Bongo H
Bongo L
Timbale H
Timbale L
Cowbell
Claves
Guiro Long
Guiro Short
Maracas
Vibraslap
PERCUSSION 2
Surdo Mute
Surdo Open
Cuica Mute
Cuica Open
Cabasa
Shaker
Agogo H
Agogo L
Samba Whistle H
Samba Whistle L
PERCUSSION 3
Tambourine
Castanet
Jingle Bells
Bell Tree
Triangle Open
Triangle Mute
Wood Block H
Wood Block L
Sticks
Whip Slap
Finger Snap
Hand Clap
PERCUSSION 4
Hi Q
Click Noise
Scratch H
Scratch L
Seq Click L
Seq Click H
Metronome Click
Metronome Bell

Hit Kit
CYMBAL
Crash Cymbal 1
Crash Cymbal 2
Splash Cymbal
Chinese Cymbal
Ride Cymbal 1
Ride Cymbal 2
Ride Cymbal Cup
Hi-Hat Open 2
Hi-Hat Closed 2
Hi-Hat Pedal 2
SNARE DRUM
Snare Ambient
Snare Tight 2
Snare Electro
Snare Roll
Stick Ambient
Snare Pitched
Brush Tap
Brush Slap
Brush Swirl
Brush Tap Swirl
TOM
Hybrid Tom 1
Hybrid Tom 2

Hybrid Tom 3
Hybrid Tom 4
Hybrid Tom 5
Hybrid Tom 6
BASS DRUM
Kick Tight H
Kick Wet
Kick Tight L
PERCUSSION 1
Conga H Open
Conga L
Conga H Mute
Bongo H
Bongo L
Timbale H
Timbale L
Cowbell
Claves
Guiro Long
Guiro Short
Maracas
Vibraslap
PERCUSSION 2
Surdo Mute
Surdo Open
Cuica Mute
Cuica Open
Cabasa
Shaker
Agogo H
Agogo L
Samba Whistle H
Samba Whistle L
PERCUSSION 3
Tambourine Light
Castanet
Jingle Bells
Bell Tree
Triangle Open
Triangle Mute
Wood Block H
Wood Block L
Sticks
Whip Slap
Finger Snap
Hand Clap
PERCUSSION 4
Hi Q
Click Noise
Scratch H
Scratch L
Seq Click L
Seq Click H
Metronome Click
Metronome Bell

Room Kit
CYMBAL
Crash Cymbal 1
Crash Cymbal 2
Splash Cymbal
Chinese Cymbal
Ride Cymbal 1
Ride Cymbal 2
Ride Cymbal Cup
Hi-Hat Open
Hi-Hat Closed
Hi-Hat Pedal
SNARE DRUM
Snare Snappy
Snare Tight Snap
Snare Soft
Snare Roll
Side Stick
Open Rim Shot
Brush Tap
Brush Slap
Brush Swirl
Brush Tap Swirl
TOM
Tom Room 1
Tom Room 2
Tom Room 3
Tom Room 4
Tom Room 5

Tom Room 6
BASS DRUM
Kick
Kick Tight
Kick Soft
PERCUSSION 1
Conga H Open
Conga L
Conga H Mute
Bongo H
Bongo L
Timbale H
Timbale L
Cowbell
Claves
Guiro Long
Guiro Short
Maracas
Vibraslap
PERCUSSION 2
Surdo Mute
Surdo Open
Cuica Mute
Cuica Open
Cabasa
Shaker
Agogo H
Agogo L
Samba Whistle H
Samba Whistle L
PERCUSSION 3
Tambourine
Castanet
Jingle Bells
Bell Tree
Triangle Open
Triangle Mute
Wood Block H
Wood Block L
Sticks
Whip Slap
Finger Snap
Hand Clap
PERCUSSION 4
Hi Q
Click Noise
Scratch H
Scratch L
Seq Click L
Seq Click H
Metronome Click
Metronome Bell

Rock Kit
CYMBAL
Crash Cymbal 1
Crash Cymbal 2
Splash Cymbal
Chinese Cymbal
Ride Cymbal 1
Ride Cymbal 2
Ride Cymbal Cup
Hi-Hat Open
Hi-Hat Closed
Hi-Hat Pedal
SNARE DRUM
Snare Rock
Snare Rock Tight
Snare Noisy
Snare Roll
Side Stick
Open Rim Shot
Brush Tap
Brush Slap
Brush Swirl
Brush Tap Swirl
TOM
Tom Rock 1
Tom Rock 2
Tom Rock 3
Tom Rock 4
Tom Rock 5
Tom Rock 6
BASS DRUM
Kick Gate

Kick 2
Kick Soft
PERCUSSION 1
Conga H Open
Conga L
Conga H Mute
Bongo H
Bongo L
Timbale H
Timbale L
Cowbell
Claves
Guiro Long
Guiro Short
Maracas
Vibraslap
PERCUSSION 2
Surdo Mute
Surdo Open
Cuica Mute
Cuica Open
Cabasa
Shaker
Agogo H
Agogo L
Samba Whistle H
Samba Whistle L
PERCUSSION 3
Tambourine
Castanet
Jingle Bells
Bell Tree
Triangle Open
Triangle Mute
Wood Block H
Wood Block L
Sticks
Whip Slap
Finger Snap
Hand Clap
PERCUSSION 4
Hi Q
Click Noise
Scratch H
Scratch L
Seq Click L
Seq Click H
Metronome Click
Metronome Bell

Electro Kit
CYMBAL
Crash Cymbal 1
Crash Cymbal 2
Splash Cymbal
Chinese Cymbal
Ride Cymbal 1
Ride Cymbal 2
Ride Cymbal Cup
Hi-Hat Open
Hi-Hat Closed
Hi-Hat Pedal
SNARE DRUM
Snare Noisy 2
Snare Noisy 3
Snare Snap Elec
Snare Roll
Side Stick
Open Rim Shot
Brush Tap
Brush Slap
Brush Swirl
Reverse Cymbal
TOM
Tom Electro 1
Tom Electro 2
Tom Electro 3
Tom Electro 4
Tom Electro 5
Tom Electro 6
BASS DRUM
Kick Gate Heavy
Kick Gate
Kick 3

PERCUSSION 1
Conga H Open
Conga L
Conga H Mute
Bongo H
Bongo L
Timbale H
Timbale L
Cowbell
Claves
Guiro Long
Guiro Short
Maracas
Vibraslap
PERCUSSION 2
Surdo Mute
Surdo Open
Scratch H 2
Scratch L 2
Cabasa
Shaker
Agogo H
Agogo L
Samba Whistle H
Samba Whistle L
PERCUSSION 3
Tambourine
Hi Q 2
Jingle Bells
Bell Tree
Triangle Open
Triangle Mute
Wood Block H
Wood Block L
Sticks
Whip Slap
Finger Snap
Hand Clap
PERCUSSION 4
Hi Q
Click Noise
Scratch H
Scratch L
Seq Click L
Seq Click H
Metronome Click
Metronome Bell

Analog Kit
CYMBAL
Crash Analog
Crash Cymbal 2
Splash Cymbal
Chinese Cymbal
Ride Cymbal 1
Ride Cymbal 2
Ride Cymbal Cup
Hat Open Analog
Hat Close Analog
Hat Close Anlg 2
SNARE DRUM
Snare Analog
Snare Analog 2
Snare Noisy 4
Snare Roll
Side Stick Anlg
Open Rim Shot
Brush Tap
Brush Slap
Brush Swirl
Reverse Cymbal
TOM
Tom Analog 1
Tom Analog 2
Tom Analog 3
Tom Analog 4
Tom Analog 5
Tom Analog 6
BASS DRUM
Kick Analog
Kick Anlg Short
Kick 3
PERCUSSION 1
Conga Analog M
Conga Analog L

Conga Analog H
Bongo H
Bongo L
Timbale H
Timbale L
Cowbell Analog
Claves 2
Guiro Long
Guiro Short
Maracas 2
Vibraslap
PERCUSSION 2
Surdo Mute
Surdo Open
Scratch H 2
Scratch L 2
Cabasa
Shaker
Agogo H
Agogo L
Samba Whistle H
Samba Whistle L
PERCUSSION 3
Tambourine
Hi Q 2
Jingle Bells
Bell Tree
Triangle Open
Triangle Mute
Wood Block H
Wood Block L
Sticks
Whip Slap
Finger Snap
Hand Clap
PERCUSSION 4
Hi Q
Click Noise
Scratch H
Scratch L
Seq Click L
Seq Click H
Metronome Click
Metronome Bell

Dance Kit
CYMBAL
Crash Analog
Crash Cymbal 2
Splash Cymbal
Chinese Cymbal
Ride Cymbal 1
Ride Analog
Ride Cymbal Cup
Hi-Hat Open 3
Hi-Hat Closed 3
Hat Close Anlg 3
SNARE DRUM
Snare Clap
Snare Dry
Snare Techno
Reverse Dance 2
Side Stick Anlg
Rim Gate
Snare Analog 3
Snare Analog 4
Vinyl Noise
Reverse Cymbal
TOM
Tom Dance 1
Tom Dance 2
Tom Dance 3
Tom Dance 4
Tom Dance 5
Tom Dance 6
BASS DRUM
Kick Techno
Kick Techno L
Kick Techno Q
PERCUSSION 1
Conga Analog M
Conga Analog L
Conga Analog H
Bongo Analog H
Bongo Analog L

Timbale H
Timbale L
Cowbell Dance
Claves 2
Guiro Long
Guiro Short
Maracas 2
Vibraslap Analog
PERCUSSION 2
Kick Dance 1
Kick Dance 2
Dance Breath 1
Dance Breath 2
Cabasa
Shaker
Agogo H
Agogo L
Samba Whistle H
Samba Whistle L
PERCUSSION 3
Tambourine Anlg
Hi Q 2
Jingle Bells
Bell Tree
Triangle Open
Triangle Mute
Dance Perc 3
Dance Perc 4
Snare Dance 1
Whip Slap
Finger Snap
Dance Clap
PERCUSSION 4
Hi Q
Click Noise
Scratch Dance 1
Scratch Dance 2
Dance Perc 2
Hi Q Dance 1
Dance Perc 1
Reverse Dance 1

Jazz Kit
CYMBAL
Crash Cymbal 1
Crash Cymbal 2
Splash Cymbal
Chinese Cymbal
Ride Cymbal 1
Ride Cymbal 2
Ride Cymbal Cup
Hi-Hat Open
Hi-Hat Closed
Hi-Hat Pedal
SNARE DRUM
Snare Jazz L
Snare Jazz M
Snare Jazz H
Snare Roll
Side Stick Light
Open Rim Shot
Brush Tap
Brush Slap
Brush Swirl
Brush Tap Swirl
TOM
Floor Tom L
Floor Tom H
Low Tom
Mid Tom L
Mid Tom H
High Tom
BASS DRUM
Kick Jazz
Kick Tight
Kick Soft
PERCUSSION 1
Conga H Open
Conga L
Conga H Mute
Bongo H
Bongo L
Timbale H
Timbale L
Cowbell

Claves
Guiro Long
Guiro Short
Maracas
Vibraslap
PERCUSSION 2
Surdo Mute
Surdo Open
Cuica Mute
Cuica Open
Cabasa
Shaker
Agogo H
Agogo L
Samba Whistle H
Samba Whistle L
PERCUSSION 3
Tambourine
Castanet
Jingle Bells
Bell Tree
Triangle Open
Triangle Mute
Wood Block H
Wood Block L
Sticks
Whip Slap
Finger Snap
Hand Clap
PERCUSSION 4
Hi Q
Click Noise
Scratch H
Scratch L
Seq Click L
Seq Click H
Metronome Click
Metronome Bell

Brush Kit
CYMBAL
Crash Cymbal 1
Crash Cymbal 2
Splash Cymbal
Chinese Cymbal
Ride Cymbal 1
Ride Cymbal 2
Ride Cymbal Cup
Hi-Hat Open
Hi-Hat Closed
Hi-Hat Pedal
SNARE DRUM
Brush Slap 3
Brush Tap 2
Brush Slap 2
Snare Roll
Side Stick Light
Open Rim Shot
Brush Tap
Brush Slap
Brush Swirl
Brush Tap Swirl
TOM
Tom Brush 1
Tom Brush 2
Tom Brush 3
Tom Brush 4
Tom Brush 5
Tom Brush 6
BASS DRUM
Kick Jazz
Kick Tight
Kick Soft
PERCUSSION 1
Conga H Open
Conga L
Conga H Mute
Bongo H
Bongo L
Timbale H
Timbale L
Cowbell
Claves
Guiro Long
Guiro Short

Maracas
Vibraslap
PERCUSSION 2
Surdo Mute
Surdo Open
Cuica Mute
Cuica Open
Cabasa
Shaker
Agogo H
Agogo L
Samba Whistle H
Samba Whistle L
PERCUSSION 3
Tambourine
Castanet
Jingle Bells
Bell Tree
Triangle Open
Triangle Mute
Wood Block H
Wood Block L
Sticks
Whip Slap
Finger Snap
Hand Clap
PERCUSSION 4
Hi Q
Click Noise
Scratch H
Scratch L
Seq Click L
Seq Click H
Metronome Click
Metronome Bell

Symphony Kit
CYMBAL
Hand Cymbal
Hand Cymbal 2
Splash Cymbal
Chinese Cymbal
Hand Cymbal S
Hand Cymbal 2 S
Ride Cymbal Cup
Hi-Hat Open
Hi-Hat Closed
Hi-Hat Pedal
SNARE DRUM
Band Snare
Band Snare 2
Snare Soft
Snare Roll
Side Stick
Open Rim Shot
Brush Tap
Brush Slap
Brush Swirl
Brush Tap Swirl
TOM
Floor Tom L
Floor Tom H
Low Tom
Mid Tom L
Mid Tom H
High Tom
BASS DRUM
Gran Cassa Mute
Gran Cassa
Kick Soft 2
PERCUSSION 1
Conga H Open
Conga L
Conga H Mute
Bongo H
Bongo L
Timbale H
Timbale L
Cowbell
Claves
Guiro Long
Guiro Short
Maracas
Vibraslap

PERCUSSION 2
Surdo Mute
Surdo Open
Cuica Mute
Cuica Open
Cabasa
Shaker
Agogo H
Agogo L
Samba Whistle H
Samba Whistle L
PERCUSSION 3
Tambourine
Castanet
Jingle Bells
Bell Tree
Triangle Open
Triangle Mute
Wood Block H
Wood Block L
Sticks
Whip Slap
Finger Snap
Hand Clap
PERCUSSION 4
Hi Q
Click Noise
Scratch H
Scratch L
Seq Click L
Seq Click H
Metronome Click
Metronome Bell

SFX Kit 1
SFX
Cutting Noise 1
Cutting Noise 2
String Slap
Flute Key Click
Shower
Thunder
Wind
Stream
Bubble
Feed
Ghost
Maou
Dog
Horse
Bird Tweet

SFX Kit 2
SFX 1
Phone Call
Telephone Ring
Wind Chime
Door Squeak
Door Slam
Scratch Cut
Scratch H 3
Laugh
Scream
Punch
Heart Beat
Foot Steps
SFX 2
CarEngnIgnition
Car Tires Squeal
Car Passing
Car Crash
Siren
Train
Jet Plane
Starship
Burst
Roller Coaster
Submarine
Machine Gun
Laser Gun
Explosion
Firework

Arabic Kit
ARABIC 1
Nakarazan Dom
Nakarazan Edge
Hager Dom
Hager Edge
Zagrouda H
Zagrouda L
Arabic Hand Clap
Duhulla Dom
Duhulla Tak
Duhulla Sak
Doff Dom
Doff Tak
ARABIC 2
Katam Dom
Katam Tak
Katam Sak
Tabla Dom
Tabla Tak 1
Tabla Tak 2
Tabla Sak
Tabla Tik
Tabla Roll Edge
Tabla Flam
Tabel Dom
Tabel Tak
ARABIC 3
Sagat 1
Sagat 2
Sagat 3
Rik Dom
Rik Tak 1
Rik Tak 2
Rik Sak
Rik Tik
Rik Finger 1
Rik Finger 2
Rik BrassTremolo
CYMBAL/SNARE DRUM
Crash Cymbal 1
Crash Cymbal 2
Ride Cymbal 1
Hi-Hat Open
Hi-Hat Closed
Hi-Hat Pedal
Snare Drum
Snare Soft
Side Stick
TOM/BASS DRUM
Floor Tom L
Floor Tom H
Low Tom
Mid Tom L
Mid Tom H
High Tom
Kick Soft
PERCUSSION
Conga H Open
Conga L
Conga H Mute
Bongo H
Bongo L
Cowbell
Claves
Cabasa
Tambourine

Pop Latin Kit
CONGA
Conga H Tip
Conga H Heel
Conga H Open
Conga H Mute
Conga H SlapOpen
Conga H Slap
Conga H SlapMute
Conga L Tip
Conga L Heel
Conga L Open
Conga L Mute
Conga L SlapOpen
Conga L Slap
Conga L Slide

BONGO
Bongo H Open 1 f
Bongo H Open 3 f
Bongo H Rim
Bongo H Tip
Bongo H Heel
Bongo H Slap
Bongo L Open 1 f
Bongo L Open 3 f
Bongo L Rim
Bongo L Tip
Bongo L Heel
Bongo L Slap
PERCUSSION 1
Timbale H Open
Timbale L Open
Paila H
Paila L
Cowbell Top
Tambourine
Guiro Long
Guiro Short
Maracas
Cuica Open
Cuica Mute
Cabasa
Shaker
PERCUSSION 2
Triangle Open
Triangle Mute
Wind Chime
Hand Clap

6 Registration Memory

Registration Memory allows you to store virtually all the settings you make on the panel and LCD, providing a convenient way to instantly change all Voice settings and rhythms while you're playing, with the simple touch of a single button on the Registration Memory panel. The buttons are conveniently located between the Upper and Lower keyboards for easy access while playing. Moreover, you can also recall the settings using the right footswitch. All Registrations in Registration Memory can also be saved to a USB flash memory or other external media.



Various types of basic Registrations have been programmed to the numbered Registration Memory buttons, 1 – 16. When you record your own Registration settings to a numbered button, the preset Registration for that button will be overwritten and erased as a result. When you initialize the Registration Memory (page 85), the preset settings will be recalled and your own Registration setting(s) will be erased and replaced with the factory defaults.

Contents

1 Storing Registrations	80	5 Registration Shift	85
2 Selecting Registrations	82	• Setting the Registration Shift mode in the Regist Shift display	86
3 Saving the Registration data to USB flash memory	84	• Confirming the Registration Shift setting in the Voice Display	88
4 Initializing Registration Memory	85	6 Unifying a specific parameter	90
		7 Copying Registrations	93

1 Storing Registrations

Newly created Registrations you make can be stored to the Registration Memory panel buttons. All Registrations in Registration Memory can also be saved to a USB flash memory or other external media for future recall.



Reference Pages

- Selecting a Voice (page 23)
- Selecting a Rhythm (page 51)
- Voice Controls and Effects (page 38)

1 Create your original Registration.

2 While holding down the [M.] (Memory) button in the Registration Memory section, press the numbered button to which you wish to save your Registration.

1. While holding down [M.] button...

2. Press desired numbered button.

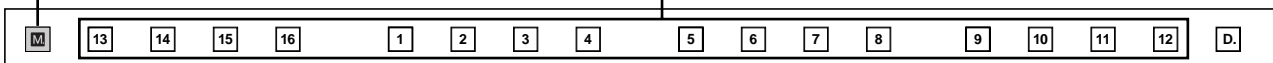

When the Registration is stored, the numbered button flashes momentarily.



When recording Registration settings, the square at the top left of the display turns light blue for a few seconds, indicating that the Registration is currently being saved. Do not turn the power off while the Registration is being saved.

Functions and settings that cannot be memorized:

The following settings cannot be stored to a Registration Memory number.

- Pitch (page 193)
- MIDI Control settings (page 221)
- Mic. Volume (page 215)
- Mic. Reverb (page 215)
- LCD related settings (page 15)
- Internet Direct Connection settings (page 203)
- Score related settings except Next Page (page 123)

The following settings common to all Registration Memory numbers 1 – 16 and cannot be stored individually for each number.

- Transpose (page 193)
- Attack mode in Organ Flute Voices (page 36)
- Registration Shift (page 85)
- Auto Fill setting (page 54)
- Reverb type (page 44)
- User Voices (page 141)
- User rhythms (page 167)
- User Keyboard Percussion (page 70)
- Rhythm Sequences (page 174)
- Disable setting (page 82)
- Disable mode (page 83)
- Next Page setting of score setting (page 123)



Reference Page

Saving Registrations as
Registration Data (File);
(page 111)

2 Selecting Registrations

Simply press the numbered button that corresponds to the Registration you wish to select.

- You can also recall Registrations by using the right footswitch. This function is called “Registration Shift” (page 85).
- You can also program the Registrations to change automatically at specific points within the Rhythm Sequence. This function is called “Registration Sequence” (page 179).

Using the [D.] (Disable) button:

Rhythm and automatic accompaniment patterns also change when you select different Registration Memory buttons. Pressing the [D.] (Disable) button allows you to keep the same rhythm, accompaniment patterns, tempo, and so on throughout all your Registration changes, or make your own rhythm selections if you want to.

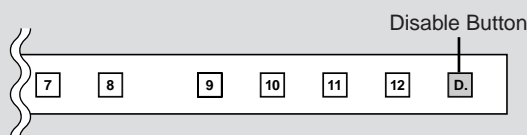

The particular settings that do not change when the [D.] (disable) button is on depend on the Disable mode setting. For details on the Disable mode, see “Selecting Disable Mode” on page 83.

Selecting Disable Mode:

The Disable mode enables you to select what is to be disabled when the [D.] (Disable) button is on. There are two Disable modes: NORMAL (rhythm menu, tempo, etc. are disabled) and TEMPO (only tempo is disabled).

- 1 Press the [UTILITY] button to call up the GLOBAL Page of the Utility Display.
- 2 Press the DISABLE MODE [NORMAL] or [TEMPO] button.

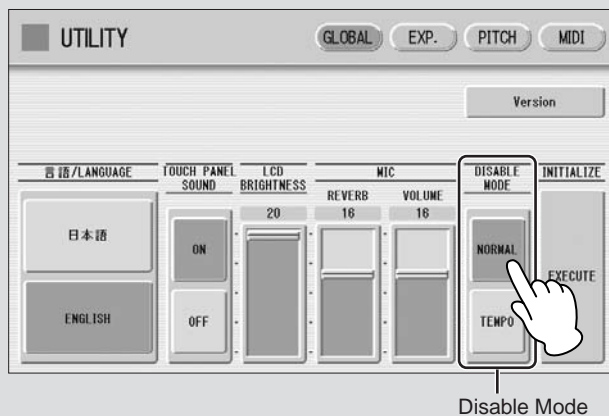

NORMAL

When the Electone is set to the NORMAL mode and the [D.] (Disable) button is on, the following functions will not change, even when you change the Registration Memory number.

- Rhythm menu, Rhythm section, Rhythm tempo, Rhythm volume, Rhythm reverb
- Rhythm reverb time
- Accompaniment volume, Accompaniment reverb, On/Off status of Accompaniment parts
- A.B.C. mode, A.B.C. memory
- M.O.C. mode, Knee lever control for M.O.C.
- Second expression pedal control for rhythm tempo

TEMPO

When the Electone is set to the TEMPO mode and the [D.] (Disable) button is on, the rhythm tempo will not change, even when you change the Registration Memory number.

3 Saving the Registration data to USB flash memory



Reference Page

Saving Registrations as Registration Data (File); (page 111)

You can save your Registration Memory settings to an external storage device, such as USB flash memory, with sixteen Registrations comprising a single file.

The instructions below explain how to save the Registration data to a USB flash memory. For details about using other external storage devices, see chapter 7, Music Data Recorder (M.D.R.).

1 Insert a USB flash memory into the USB TO DEVICE terminal.

2 Press the [MDR] button on the panel to call up the M.D.R. display.

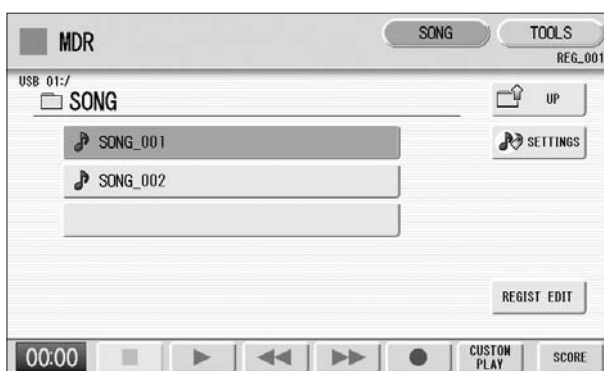
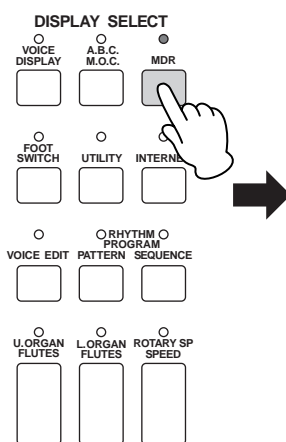

3 Select the song to which you want to save the Registration data (page 103).

4 Press [REGIST EDIT] button in the display to call up the Registration Edit display.

5 Press the [SAVE] button in the display.

A message appears, indicating the Registration data is currently being saved. When the operation is completed, the message closes.



Reference Page

Recalling Recorded Registrations (page 115)



Reference Page

Changing the Song Name (page 108)

4 Initializing Registration Memory

Deleting all Registration data in Registration Memory initializes the Registration Memory. Be careful when using this operation, since it erases all your existing data. In order to avoid inadvertently losing your important data, save it to an external storage device.



Reference Page

Factory Set (Initializing the Electone); (page 21)

- 1 Press the [UTILITY] button on the panel to call up the GLOBAL Page in the Utility display.

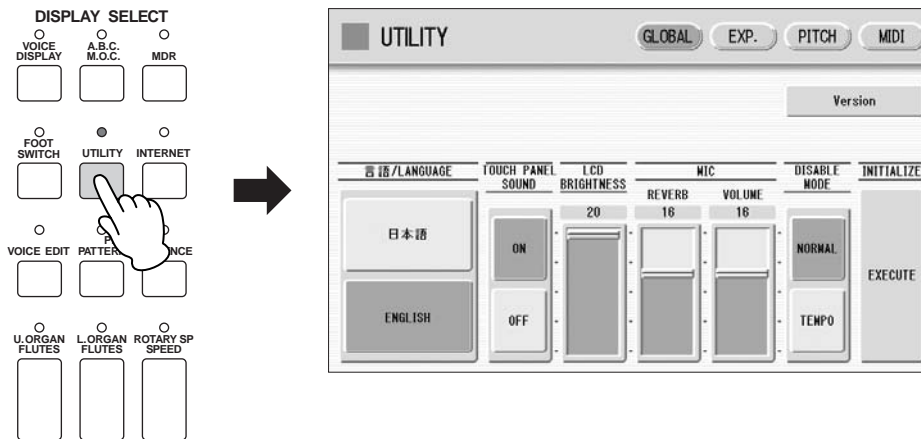

- 2 Press the INITIALIZE [EXECUTE] button on the right side in the display.

The message “Are you sure you want to initialize Registration data?” appears. Press [INITIALIZE] to actually initialize the data. When the operation is complete, the Electone will be restarted. Press [CANCEL] to cancel the operation.

5 Registration Shift

The Registration Shift function allows you to change Registrations without taking your hands from the keyboards. By using the Right Footswitch on the expression pedal, you can “jump” to a specified Registration or step through the panel Registrations in sequence, either in numeric order or in any order you specify.

Registration Shift has three modes: Shift, Jump and User. These are set in the Regist Shift display. You can also view and check the Registration Shift mode in the Voice Display.

Setting the Registration Shift mode in the Regist Shift display

1 Press the [FOOT SWITCH] button on the panel.

2 Press the [RIGHT] button at the top right of the display to call up the RIGHT Page (Regist Shift display).

REGIST SHIFT Display

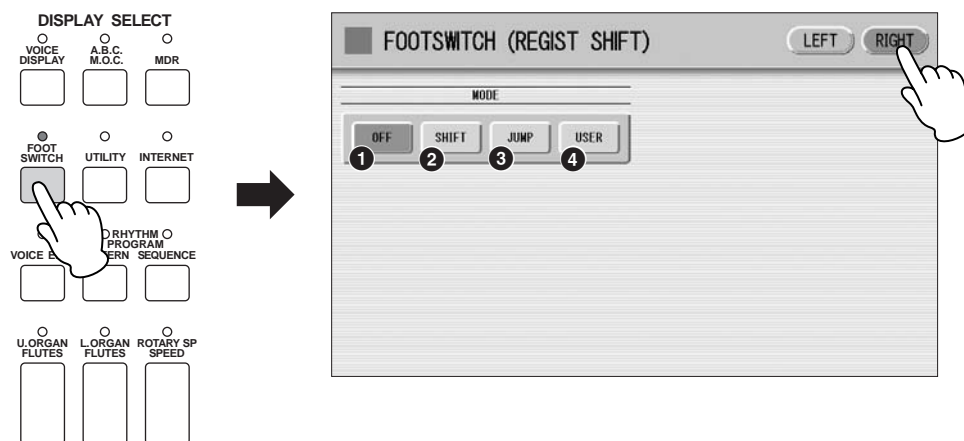



1 OFF

Turns off the Registration Shift assignment. When you select OFF, you cannot change Registrations by using the Right Footswitch.

2 SHIFT

In the Shift mode, each press of the Right Footswitch selects the Registration Memory presets in their numerical order. After the last Registration is reached, the function 'wraps around' to select the first preset again. The numbered buttons light up as they are selected.

3 JUMP

Pressing the Right Footswitch jumps to select the designated panel Registration. You can set the Jump "destination" with   buttons in the display or the Data Control dial.

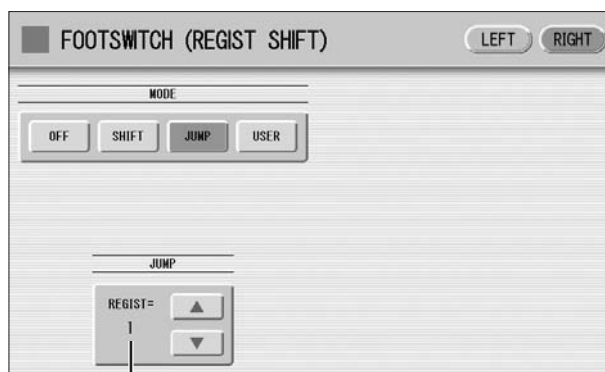

Registration number of the destination

4 USER

In the User mode, each press of the Right Footswitch selects Registrations according to the order you've specified.

To set the User Registration order:

1 Press the desired numbered button in the Registration Memory section.

2 Press the [SET] button in the display.

The Registration number appears in the display, indicating that the Registration is entered.

3 Repeat the above procedure 1 through 2 to set the Registration order.

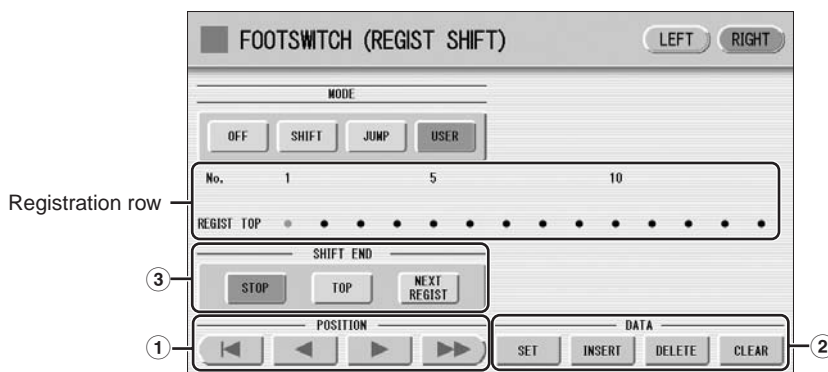

① POSITION

These are cursor controls used to move the cursor (colored orange) along the Registration row in the display. Entered Registration numbers are shown in boxes, while the numbers in the row above indicate the position in the sequence (in other words, the number of successive presses of the Right Footswitch). Up to 80 steps (Registrations) can be memorized.

- Moves the cursor to the first position.
- Moves the cursor one step to the left.
- Moves the cursor one step to the right.
- Moves the cursor five steps to the right.

② DATA

These are data controls used to enter and delete Registration numbers in the Registration row.

SET: For initially entering a Registration number to a blank space in the Registration row, or for replacing a number at the current cursor position.

To enter a number, press the desired Registration Memory button (the selected button will light), then press [SET] in the display. The entered Registration number will appear in the Registration row. After using SET to enter Registrations, the cursor can be moved among the numbers.

INSERT: For inserting a Registration number just before the current cursor position.

To perform the operation, first move the cursor to a numbered position. Then, press the desired Registration Memory button (the selected button will light), and press [INSERT] in the display. The new Registration number is inserted at the cursor position and all other numbers to the right of the cursor are moved to accommodate the new numbers.

Registration numbers cannot be entered beyond the Registration Shift function's capacity of 80. If the insert operation exceeds this capacity, a "Data Full" message appears and the operation cannot be executed.



Reference Page

Saving Two or More Registration Banks to One Song (page 111)



NOTE

When you play the song using Next Regist. function, always press the [▶] (Play) button in the M.D.R. display to start the song and activate these functions. The [CUSTOM] (Custom Play) button will not activate the Next Regist. function.



NOTE

If the next Registration data contains User voices and/or VA custom voices, the Electone may produce no sound for a few seconds while loading the Registration.



NOTE

When you use the Next Regist function during Rhythm playback, Rhythm Sequence and User Rhythm cannot be loaded.

DELETE: For deleting a Registration number at the current cursor position. To delete the unnecessary number, move the cursor to a numbered position and press [DELETE] in the display.

CLEAR: For erasing all current user Registration Shift settings.

After selecting [CLEAR], a message appears prompting confirmation of the operation.

Select [CLEAR] to clear all data. The message “Clear all data” momentarily appears in the display and returns to the previous display.

Select [CANCEL] to abort the operation.

③ SHIFT END

Determines how to end the Registration shift function.

STOP: Selects the last Registration and quits the operation.

TOP: After the last preset is reached, the first preset is called up again, starting the sequence over again from the beginning.

NEXT REGIST: After the last preset is reached, the next Registration data in the Song is called up. This function is available only when two or more Registration data sets are saved in one Song. This function is handy when you need to play a song with more than sixteen Registrations.

The Shift End mark (◀▶) will automatically be put at the end of the Registrations you entered when Top or Next Regist is selected as the Shift End.

Confirming the Registration Shift setting in the Voice Display

You can confirm the Registration Shift mode in the Voice Display, Page 1.

Press the [VOICE DISPLAY] button on the panel to call up the Voice Display.

The Registration Shift mode is shown at the bottom right of the display.

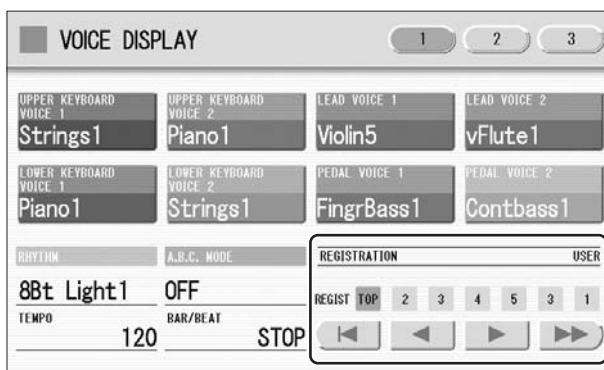
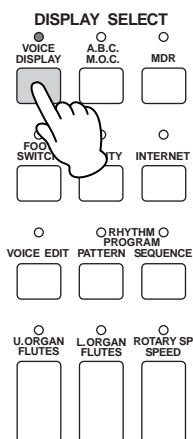

Registration Shift, OFF:

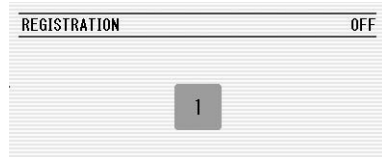

The current Registration number is displayed.

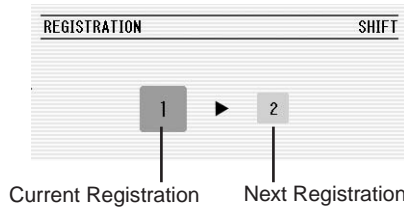

Registration Shift, in “SHIFT” mode:

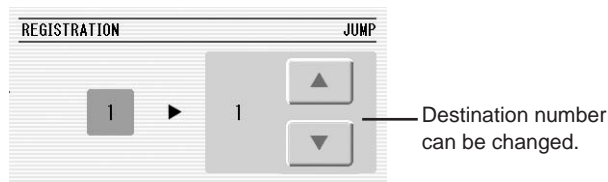

The current Registration number (left) and the next number (right) are displayed.

Registration Shift, in “JUMP” mode:





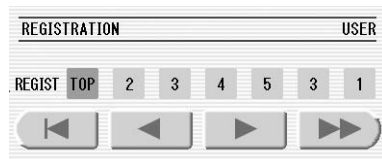

The current Registration number (left) and the destination number (right) will be displayed. You can change the destination number even in the middle of the performance by using the   buttons in the display or the Data Control dial.

Registration Shift, in “USER” mode:



Indicates the current position of the Registration Shift. You can change the Registration by moving the cursor (in orange) right/left, using the displayed buttons or the Data Control dial. This is handy if you’ve inadvertently advanced the shift setting in the middle of your performance. The user Registration settings cannot be edited here.

-  Moves the cursor to the first position.
-  Moves the cursor one step to the left and selects the next Registration.
-  Moves the cursor one step to the right and selects the previous Registration.
-  Moves the cursor five step to the right and selects the Registration.

6 Unifying a specific parameter

In the Voice Display, Page 2, you can conveniently “unify” a specific parameter used in different Voice groups at one time. This is useful when you are changing, for example, the Voice Brilliance setting for the Upper Keyboard and want the same setting to be applied to the entire instrument.

Available parameters

- Reverb
- Panning
- Rhythm Reverb
- Brilliance
- Volume
- Sustain

1 Press the [VOICE DISPLAY] button on the panel.

2 Press the [2] button at the top right of the display to select Page 2.

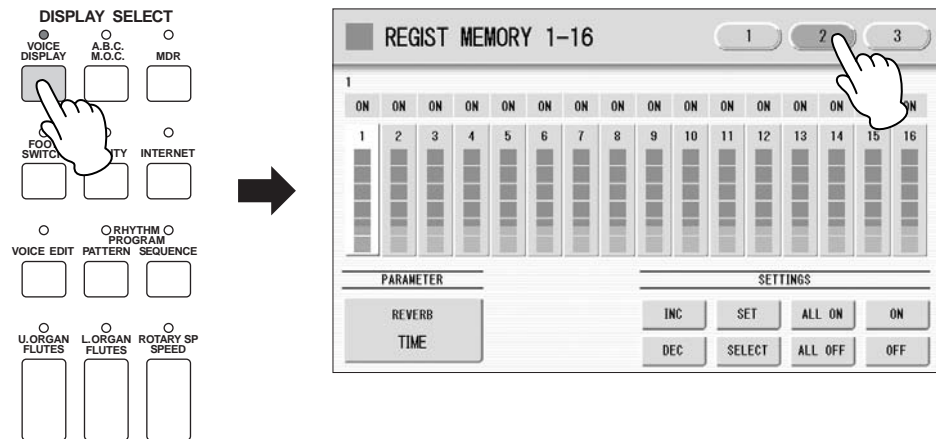

3 Press the PARAMETER button (indicates the currently selected parameter) in the display to select the desired parameter for changing.

The Parameter Select pop-up menu appears, letting you select the desired parameter.

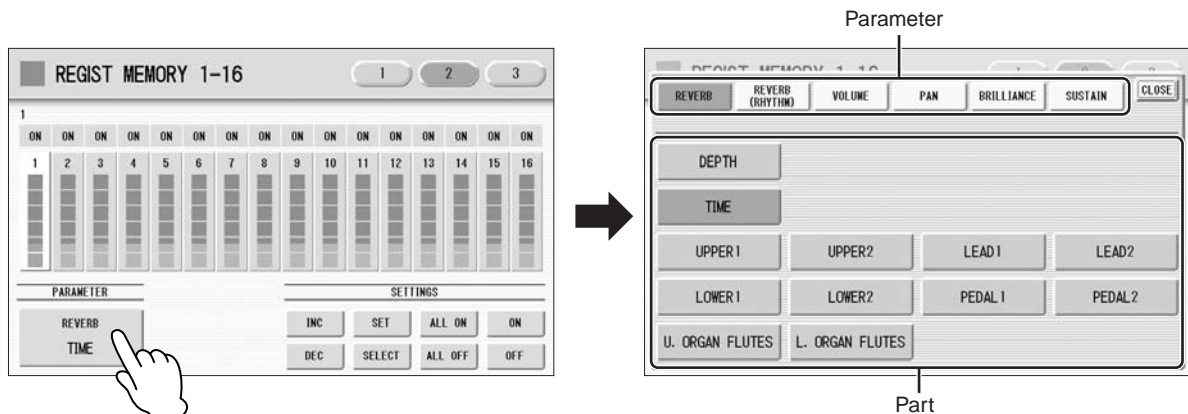

Select the parameter and part in the Parameter Select pop-up menu. After selecting the desired parameter, the pop-up menu automatically closes.

The amount of the selected parameter for each Registration is shown in the display.

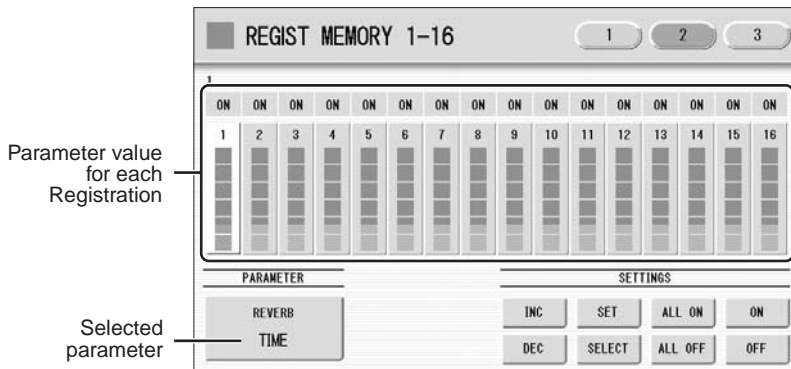

4 Select the targeted Registration numbers and turn them on.

Parameters in Registrations set to ON will be changed.

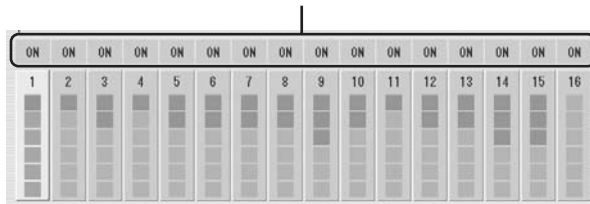

Press the targeted Registration in the display and turn it on with the SETTINGS buttons: ALL ON, ALL OFF, ON, OFF, and SELECT.

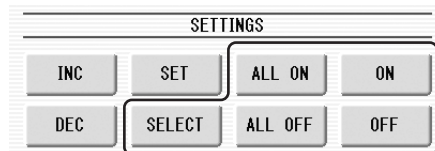

ALL ON: Selects all Registration memory numbers.

ALL OFF: Cancels all Registration memory numbers.

ON: Sets the currently selected Registration memory number to “ON.”

OFF: Sets the currently selected Registration memory number to “OFF.”

SELECT: Turns on the Registration memory numbers that contain the same Voice as the one which is currently set in the Registration at the cursor position. The targeted Registration numbers are underlined.

5 Unifies the currently turned-on parameter's values.

You unify the relevant parameter values in each Registration memory number or offset them. Keep in mind that you cannot restore the original data once you change the parameter's value.

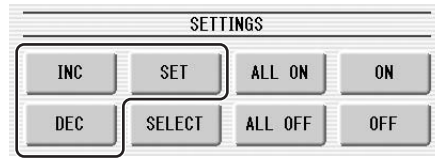

Unifying the currently turned-on parameter's value:

Pressing [SET] unifies the currently turned-on parameter's values to the one in the currently selected Registration (at the cursor position). A message appears prompting you to confirm the operation.



To continue the operation, select [UNIFY]. Select [CANCEL] to abort the operation.

Offsetting the currently turned-on parameter's value.

Pressing the [+]/[-] buttons in the display or using the Data Control dial offsets the currently turned-on parameter's value. If you select Pan as the parameter, [◀]/[▶] buttons are shown instead of [+]/[-].

If you change the value, and if parameter values for some Registration memory number reach the maximum or minimum, the following message appears.

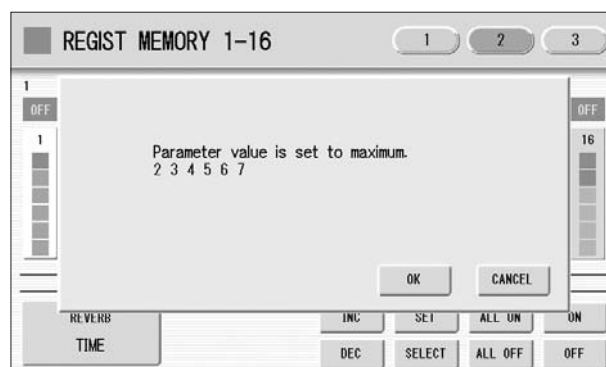

In this case, pressing [OK] continues the operation, ignoring those parameters at maximum or minimum value. Pressing [CANCEL] aborts the operation.

7 Copying Registrations

In the Voice Display, Page 3, you can copy a Registration stored to a specific Registration Memory number to another number on a specific section basis (Voices, rhythm, keyboard percussion). (The function is called Regist Section Copy.) This is useful, for example, when you want the upper keyboard Voice in Registration number 4 to be the same as in Registration number 1.

- 1 Press the [VOICE DISPLAY] button on the panel to call up the Voice Display.
- 2 Press the [3] button at the top right of the display to call up Page 3.

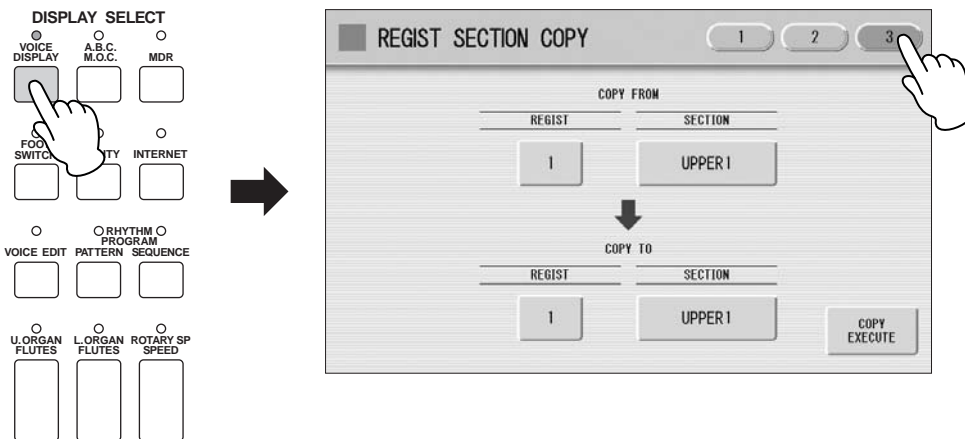

- 3 Press the COPY FROM [REGIST] number button and select the Registration number that you wish to copy.

To abort the operation press the [CLOSE] button.

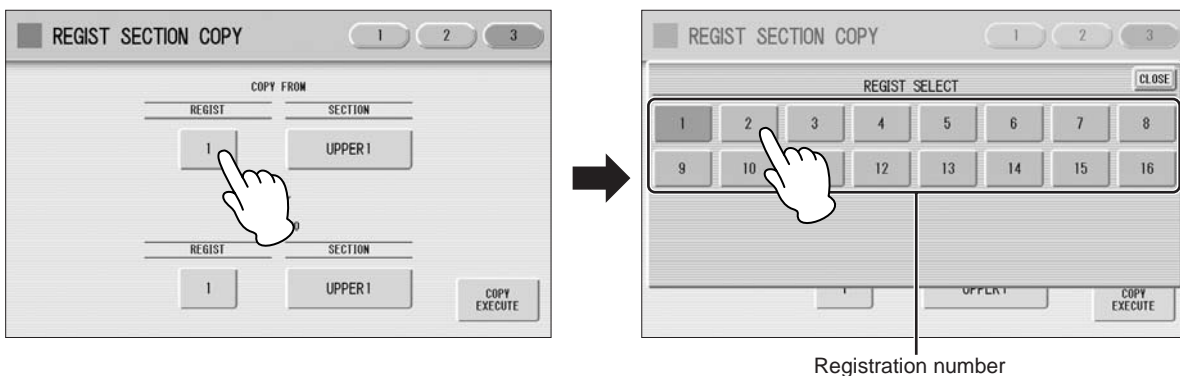

4 Press the COPY FROM [SECTION] button and select the Regist Section that you wish to copy.

To abort the operation press the [CLOSE] button.

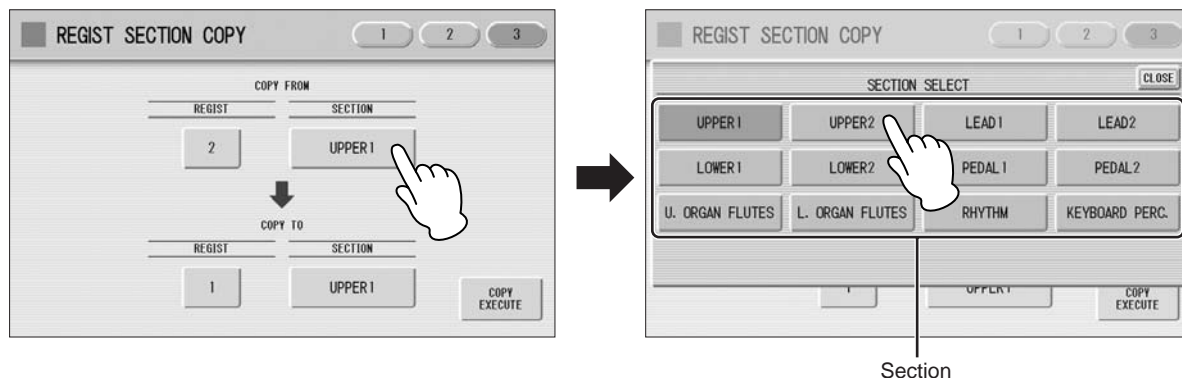

NOTE

If you change the source Regist Section after changing the destination Regist Section the destination may automatically change to the section selected as the source Regist Section.

5 In the same way, select the COPY TO Registration number and Regist Section.

The COPY TO Regist Section depends on the Regist Section selected for COPY FROM.

6 Press the [COPY EXECUTE] button at the bottom right in the display.

The following display appears, prompting confirmation of the operation.

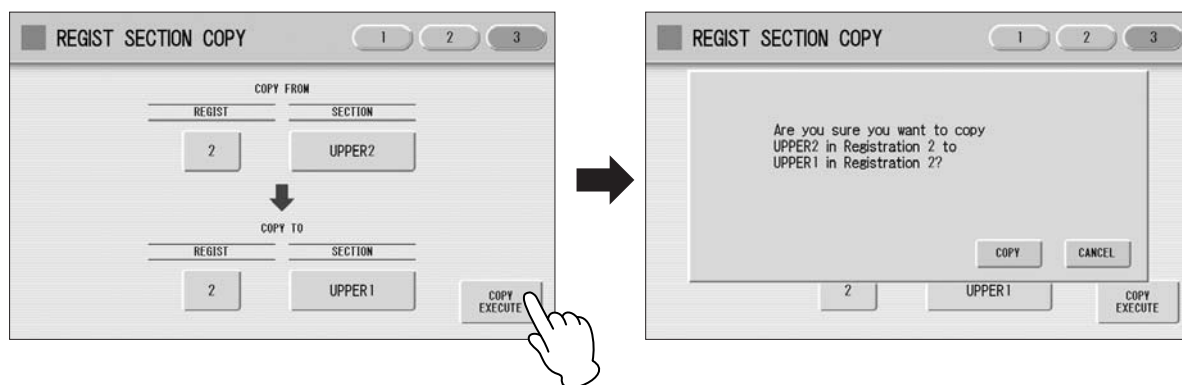

7 Press the [COPY] button in the display to copy the Registration and a message momentarily appears in the display indicating that the Registration has been copied.

Select [CANCEL] to abort the operation.

Music Data Recorder (MDR)

The Music Data Recorder (M.D.R.) is a sophisticated recording system built into the Electone that lets you record your performances and Registration settings to a USB flash memory or other external media. If you install the optional floppy disk drive such as the UD-FD01 to the Electone, you can record your performances/settings to floppy disks.

Before using an external media such as USB flash memory, carefully read “Precautions when using the USB TO DEVICE terminal” section on page 100.

Contents

1 Calling Up the M.D.R. Display	95	
2 Using the LCD Display	96	
• Song Icons	98	
• Precautions when using the USB TO DEVICE terminal	100	
• Handling the floppy disk drive (FDD) and floppy disks	101	
3 Formatting External Media	102	
4 Selecting a Song	103	
5 Recording	105	
• Recording your performance	105	
• Re-recording (Retry)	106	
• Recording each part separately	106	
• Punch-in Recording	108	
6 Changing the Song Name	108	
7 Saving Registrations as Registration Data (File)	111	
• Saving Two or More Registration Banks to One Song	111	
• Replacing Registrations	112	
		• Next Regist (Registration) Settings (Changing the order of the Registration data)
		113
		8 Recalling Recorded Registrations
		115
		9 Playing Back a Song
		117
		• Playing Back the Selected Part(s)
		118
		• Fast Forward, Rewind and Pause
		119
		• Changing the Tempo
		119
		• Repeat Playback
		120
		10 Displaying the Score
		122
		• Changing the score contents and settings
		123
		11 Other Functions (Tools)
		124
		• Song Copy
		124
		• Song Delete
		126
		• Converting to XG
		128
		• Converting ELS format to EL
		129
		• Converting EL format to ELS
		129
		• Checking the Remaining Memory
		130

1 Calling Up the M.D.R. Display

Press the [MDR] button in the panel to call up the M.D.R. display. All operations related to the M.D.R., such as recording and playing your performances, can be done in the M.D.R. display.

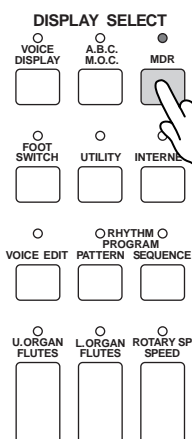

NOTE

The items shown in the display and their order differ depending on the connected external media.

Pressing any button other than the [MDR] button while the M.D.R. display is open exits from the M.D.R. display. If you exit from the function inadvertently, simply press the [MDR] button again to recall the M.D.R. display.

All the instructions in this chapter are related to the M.D.R. display. To call up the M.D.R. functions and the M.D.R. display, press the [MDR] button.

2 Using the LCD Display

The M.D.R. display consists of two display pages: the SONG Page and the TOOLS Page. In the SONG Page, you can select a song, then play it back or record it. The TOOLS Page has a variety of song utility operations, such as copy, delete, rename, etc. Pressing the [SONG] or [TOOLS] button at the top right of the display switches between the SONG Page and the TOOLS Page.

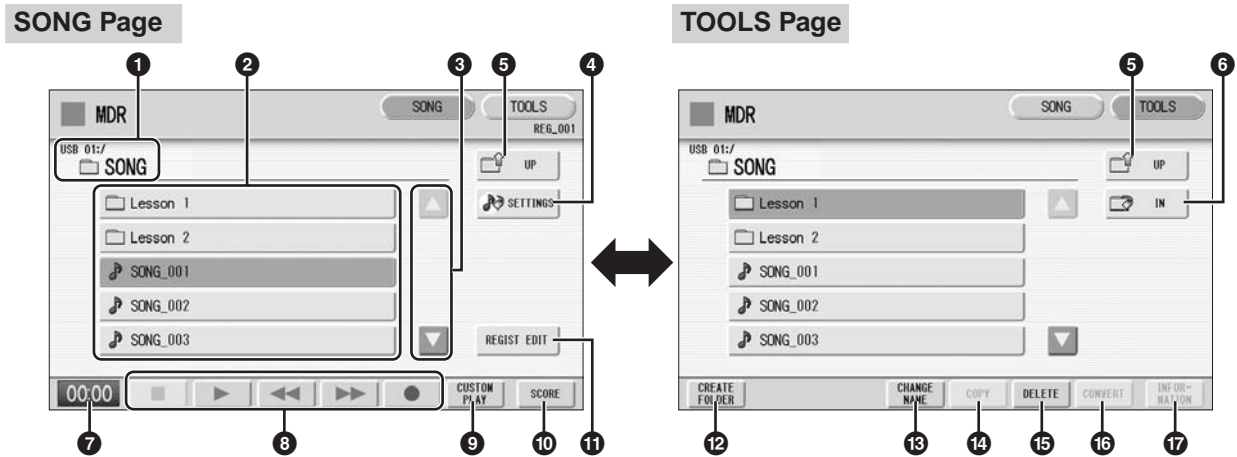

1 Current Media/Folder

Displays the currently selected media and folder(s). The left side of the indication (before “:/”) shows the particular media and the right side shows the path with currently selected folder name at the end. For example, “USB 01:/Folder1/” indicates that the folder named “Folder1” contained in the USB flash memory is selected.

2 Media/Folder/Song List

Displays the media, folders or songs. Up to 120 folders can be displayed (5 folders at once).

3 Scroll Buttons

If the Media/folder/Song List contains more than 5 media/folders/songs, you can scroll through the display with these buttons.

4 SETTINGS

Displays/changes the settings for the currently selected song.

5 UP

Selects the higher layer folder or media. For example, when “USB 01:/Folder1/” (Folder1 in the USB flash memory) is selected, pressing the [UP] button selects “USB 01:/” (USB flash memory).



Reference Page

Setting a song (page 104)

6 IN

Selects the next lower (or deeper) layer folder or media. For example, when “USB 01:/Folder1/” (Folder1 in the USB flash memory) is selected, pressing the [IN] button selects “USB 01:/Folder1/SONG/” (the SONG folder contained in Folder1 of the USB flash memory).

7 Elapsed Time

Displays the elapsed time when recording/playing back a song (up to 59 min. 59 sec.).

8 Song Control

Controls song recording, playback, etc.

9 CUSTOM PLAY

Records/plays back only the performance data of the selected songs. Using this button does not recall the Registration data.

10 SCORE

Displays the selected song's score.

11 REGIST EDIT

Displays the Regist (Registration) Edit Display for the selected song's Registration data.

12 CREATE FOLDER

Creates a new folder in the Media/Folder/Song List. Up to 120 folders can exist in one media or within a single upper folder. Pressing this button calls up the New Folder display in which you can enter the desired name. Enter the name and press the [OK] button to create a new folder. The method for entering a folder name is the same as that of the song name. See page 108.

13 CHANGE NAME

Changes the folder/song name.

14 COPY

Copies the selected song.

15 DELETE

Deletes the selected folder/song.

16 CONVERT

Converts the selected song for use on another Electone or other instruments, or converts songs recorded on another Electone for use on the ELS-01/01C. Songs can be converted to XG format, EL format or ELS format.

17 INFORMATION

Displays available memory when media is selected and displays information such as the title and composer when a song is selected. The information to be displayed depends on the songs.



Reference Pages

Recording Your Performance (page 105)
Playing Back a Song (page 117)



Reference Page

Displaying the Score (page 122)



Reference Pages

Saving Registrations as Registration Data (File) (page 111)
Recalling Recorded Registrations (page 115)



Reference Page

Changing the Song Name (page 108)



Reference Page

Song Copy (page 124)



Reference Page

Song Delete (page 126)



Reference Pages

Converting to XG (page 128)
Converting ELS format to EL (page 129)
Converting EL format to ELS (page 129)



Reference Pages

Checking the Remaining Memory (page 130)
About Protected Songs (page 116)

If media cannot be found:

- 1 Press the  button until the button is grayed out. The Media List will be displayed. If there are more than five media selections, scroll through the display with the Scroll buttons (page 96) to display the desired media.



If songs cannot be found:

- 1 Check the current media/folder (page 96).
- 2 If the desired song is stored in the currently displayed folder, use the Scroll buttons (page 96) to display the song.



NOTE







If the message "Registration data will be initialized" is displayed when you select a folder, press [INITIALIZE] button (media is not initialized). The message will appear when recalling the protected song.

If the desired song is stored in a different folder, use the  and  buttons to select the folder in which the desired song is stored.

If you are not sure of the folder in which the desired song is stored, press  button a few times to display the Media List and check the folders in which the song is likely to be stored.

Song Icons

These icons are shown when you select a media, folder, and song.

	Indicates media such as a USB flash memory or floppy disk. This icon is displayed in the Media/Folder List.
	Indicates a folder.
	Indicates that write-protect or copy-protect is effective for the media.
	Indicates that performance data is contained in the song.
	Indicates an XG-compatible song.
	Indicates a Protected Original Song. See page 116 for details.
	Indicates a Protected Edit Song. See page 116 for details.

Media Contents: Folders, Songs, and Files

Folders:

A folder is a storage location in the media, used to organize multiple songs in groups. If you've saved hundreds of songs to a USB flash memory, it may be difficult to find the desired song quickly. Organizing your songs in folders, with similar songs grouped together (for example, according to genre or tempo), makes it easier to find the songs you want.

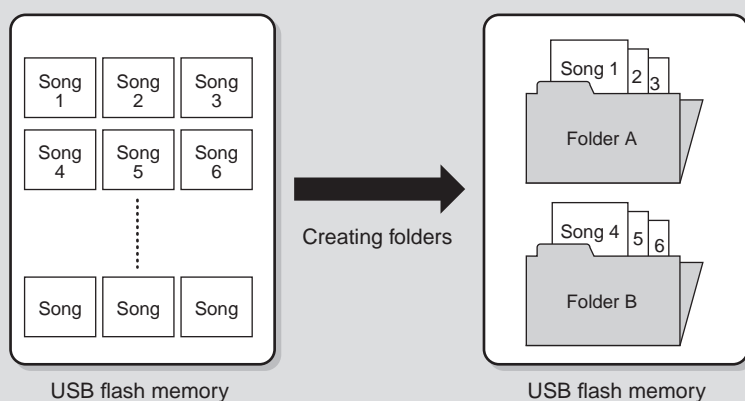

Songs:

A song is the Electone data for a piece of music, recorded to external media. A single song can contain a variety of data, including the recorded performance, Registrations, and so on.

Files:

A file is an element of data in a song. For example, a single song consists of various files, such as Registration files and performance files. The following files are created with the M.D.R. (The extension will not appear in the Electone display. They will, however, be displayed on a computer.)

Files in the song

File	Explanation	Extension
Performance data	This file contains performance data, played on the keyboards and pedals of the Electone.	.mid
Registration data	This file contains Registration settings, User Voices, User rhythms, and Rhythm Sequences.	.b00
XG-converted data	This file contains XG song data, for which Electone performance data is converted to XG-compatible format.	.mid

In addition, one file (extension: .name) is automatically created in each folder for organization/maintenance of the folder contents. It does not appear on the Electone display.

Precautions when using the USB TO DEVICE terminal

This instrument features a built-in USB TO DEVICE terminal. When connecting a USB device to the terminal, be sure to handle the USB device with care. Follow the important precautions below.



NOTE

For more information about the handling of USB devices, refer to the owner's manual of the USB device.

■ Compatible USB devices

- USB storage devices (flash memory, floppy disk drive, hard disk drive, etc.)
- USB hub
- USB-LAN adaptor

The instrument does not necessarily support all commercially available USB devices. Yamaha cannot guarantee operation of USB devices that you purchase. Before purchasing a USB device for use with this instrument, please visit the following web page:

<http://www.yamahamusicsoft.com/>



NOTE

Other USB devices such as a computer keyboard or mouse cannot be used.

■ Connecting USB device

- When connecting a USB device to the USB TO DEVICE terminal, make sure that the connector on the device is appropriate and that it is connected in the proper direction.

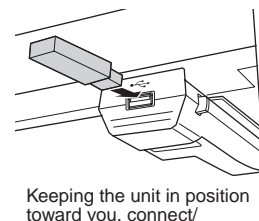
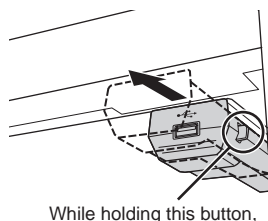

NOTE

During your performance, make sure to slide the USB unit under the keyboard. If you leave it in the forward position, there is a danger of hitting it with your hand and breaking the USB device.

- If you intend to connect two or three devices at the same time to a terminal, you should use a self-powered USB hub device. Make sure to connect the USB hub to the USB TO DEVICE terminal directly, not to the USB unit. Up to two USB hubs can be used. If an error message appears while using the USB hub, disconnect the hub from the instrument, then turn on the power of the instrument and re-connect the USB hub.
- Though the instrument supports the USB 1.1 standard, you can connect and use a USB 2.0 storage device with the instrument. However, note that the transfer speed is that of USB 1.1.

Using USB Storage Devices

By connecting the instrument to a USB storage device (external media), you can save data you've created to the connected device, as well as read data from the connected device.



NOTE

Although CD-R/RW drives can be used to read data to the instrument, they cannot be used for saving data.

■ The number of USB storage device to be used

Up to four USB storage devices can be connected to the USB TO DEVICE terminal. (If necessary, use a USB hub. The number of USB storage devices that can be used simultaneously with musical instruments even when a USB hub is used is a maximum of four.) This instrument can recognize up to four drives in one USB storage device.

■ Formatting USB storage media

When a USB storage device is connected or media is inserted, a message may appear prompting you to format the device/media. If so, execute the Format operation (page 102).



The format operation overwrites any previously existing data. Make sure that the media you are formatting does not contain important data. Proceed with caution, especially when connecting multiple USB storage media.

■ To protect your data (write-protect)

To prevent important data from being inadvertently erased, apply the write-protect provided with each storage device or media. If you are saving data to the USB storage device, make sure to disable write-protect.

■ Connecting/removing USB storage device

Before removing the media from the device, make sure that the instrument is not accessing data (such as in the Save, Copy and Delete operations).



While the instrument is accessing data (such as during Save, Copy, Delete, Load and Format operations) or is mounting the USB storage device (shortly after the connection), do NOT unplug the USB connector, do NOT remove the media from the device, and do NOT turn the power off to either device. Doing so may corrupt the data on either or both devices. If you are using a USB flash memory which has a lamp, the lamp will flash when the instrument is accessing the USB flash memory.



Avoid frequently turning the power on/off to the USB storage device, or connecting/disconnecting the device too often. Doing so may result in the operation of the instrument "freezing" or hanging up.

■ Data Backup

For maximum data security, Yamaha recommends that you keep two copies of important data on separate USB storage devices. This gives you a backup if one device is lost or damaged.

Handling the floppy disk drive (FDD) and floppy disks

If you want to use floppy disks, install the optional UD-FD01 floppy disk drive to the Electone. For information on how to install the UD-FD01, see page 224.

Be sure to handle floppy disks and treat the disk drive with care. Follow the important precautions below.

■ Floppy disk compatibility

- 3.5" 2DD and 2HD type floppy disks can be used.

■ Formatting a floppy disk

- If you find that you are unable to use new, blank disks or old disks that have been used with other devices, you may need to format them. For details on how to format a disk, see page 102. Keep in mind that all data on the disk will be lost after formatting. Make sure to check beforehand whether or not the disk contains important data.



NOTE

Floppy disks formatted on this device may or may not be useable as is on other devices.

■ Inserting/removing Floppy Disks

● Inserting a floppy disk into the disk drive

- Hold the disk so that the label of the disk is facing upward and the sliding shutter is facing forward, towards the disk slot. Carefully insert the disk into the slot, slowly pushing it all the way in until it clicks into place and the eject button pops out.



Never insert anything but floppy disks into the disk drive. Other objects may cause damage to the disk drive or floppy disks.

● Removing a floppy disk

- After checking that the instrument is not accessing* the floppy disk, firmly press the eject button at the upper right of the disk slot all the way in. When the floppy disk is ejected, pull it out of the drive. If the floppy disk cannot be removed because it is stuck, do not try to force it, but instead try pressing the eject button again, or try re-inserting the disk and attempt to eject it again.

* Access of the disk indicates an active operation, such as recording, playback, or deletion of data. If a floppy disk is inserted while the power is on, the disk is automatically accessed, since the instrument checks whether the disk has data.



Do not remove the floppy disk or turn off the instrument itself while the disk is being accessed. Doing so may result not only in loss of data on the disk but also damage to the floppy disk drive.

- Be sure to remove the floppy disk from the disk drive before turning off the power. A floppy disk left in the drive for extended periods can easily pick up dust and dirt that can cause data-read and -write errors.

■ Cleaning the disk drive read/write head

- Clean the read/write head regularly. This instrument employs a precision magnetic read/write head which, after an extended period of use, will pick up a layer of magnetic particles from the disks used that will eventually cause read and write errors.
- To maintain the disk drive in optimum working order Yamaha recommends that you use a commercially-available dry-type head cleaning disk to clean the head about once a month. Ask your Yamaha dealer about the availability of proper headcleaning disks.

■ About floppy disks

● Handle floppy disks with care, and follow these precautions:

- Do not place heavy objects on a disk or bend or apply pressure to the disk in any way. Always keep floppy disks in their protective cases when they are not in use.
- Do not expose the disk to direct sunlight, extremely high or low temperatures, or excessive humidity, dust or liquids.
- Do not open the sliding shutter and touch the exposed surface of the floppy disk inside.
- Do not expose the disk to magnetic fields, such as those produced by televisions, speakers, motors, etc., since magnetic fields can partially or completely erase data on the disk, rendering it unreadable.
- Never use a floppy disk with a deformed shutter or housing.
- Do not attach anything other than the provided labels to a floppy disk. Also make sure that labels are attached in the proper location.

● To protect your data (write-protect tab):

- To prevent accidental erasure of important data, slide the disk's write-protect tab to the "protect" position (tab open). When saving data, make sure that the disk's write-protect tab is set to the "overwrite" position (tab closed).

● Data backup

- For maximum data security Yamaha recommends that you keep two copies of important data on separate floppy disks. This gives you a backup if one disk is lost or damaged.

3 Formatting External Media



NOTE

Before purchasing a USB flash memory device, please consult your Yamaha dealer, or an authorized Yamaha distributor for advice, or see the Yamaha website (<http://www.yamahamusicsoft.com/>).



NOTE

The indications USB 1, USB 2, etc. will be displayed depending on the number of the connected media.



NOTE

"USB-FD01" appears in the display only when a floppy disk drive has been installed to the Electone.

If you find that you are unable to use new, blank external media (such as floppy disks or USB flash memory) or old one that have been used with other devices, you may need to format them.

Formatting erases all the data in the media and makes it ready to record. The data erased by formatting will be lost permanently. Check whether or not the media contains any important data you wish to keep before executing the operation. Proceed with caution, especially when connecting multiple USB storage media.

1

Connect the media to the USB TO DEVICE terminal.

2

Press the [TOOLS] button at the top right of the display to call up the TOOLS Page.

3

Press the  button repeatedly if necessary until the button is grayed out.

4

Select the desired media you want to format.

To format a USB flash memory, select [USB XX] (USB 01, USB 02, etc.).
To format a floppy disk, select [USB-FD01].

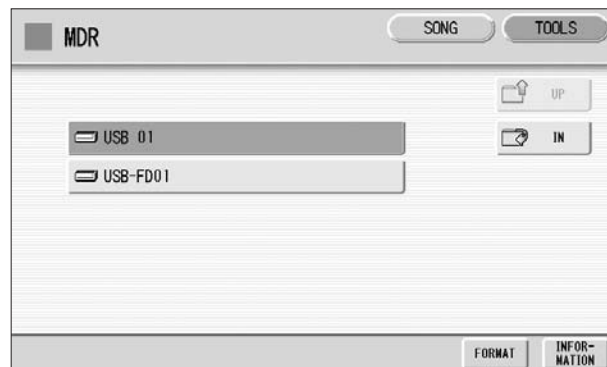

5

Press the [FORMAT] button in the display.

A message appears, prompting confirmation of the operation. Select [FORMAT] to format the media, or [CANCEL] to abort the operation.



Do not remove the media while formatting.

4 Selecting a Song

In the M.D.R. display, you can select a blank song to which you want to record your performance or save the Registration settings, or you can select a desired song for playback.

In the M.D.R. display, songs in the currently selected media are displayed. First call up the desired media (and folder, if necessary) in the display, then select the desired song.

1 Check the currently selected media at the top of the display.

For example, if you want to select a song in the USB flash memory, confirm that “USB 01:” is displayed at the top of the display.

Currently selected media/folder

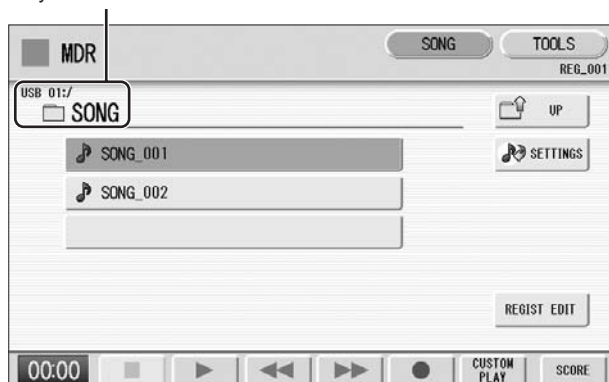

Do not remove the media while the instrument is accessing the media. (If you are using a USB flash memory which has a lamp, the lamp will flash when the instrument is accessing the USB flash memory.)

For information on selecting the desired media, see page 98.

2 Press desired song button in the display.

Referring to the song name and icons, select the desired song. The selected song button is highlighted in orange.

Song containing data



Blank song (containing no data)



Reference Pages

Changing the Song Name (page 108)
Song Icons (page 98)



Reference Pages

Playing Back the Selected Part(s) (page 118)

Changing the Tempo (page 119)

About the [SETTINGS] button

Pressing the  button calls up a display of the currently selected song, letting you confirm the tempo and parts that are played when playing the song.

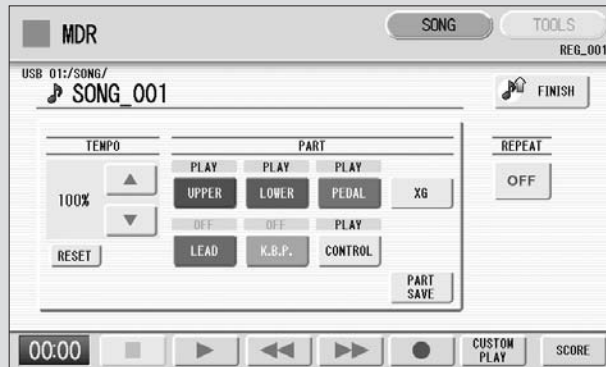

When playing back the song (by pressing the [▶] (Play) button), only those parts that are set to “PLAY” in the display actually play at the indicated tempo (over a range of 50% to 200% of the original tempo when recording). If the song contains no performance data, all parts are set to “OFF.” Pressing the [PART SAVE] button saves each part playback setting (the tempo is not saved).

5 Recording

Recording your performance

Set the desired Registrations on the Electone. Make all the Electone settings necessary for the song you will record. This means entering the all Registrations you will need for the entire performance in the Registration Memory. Make sure also to select the Registration that you will use at the beginning of the song.

1 Insert a media to the USB TO DEVICE terminal.

2 Select a blank song for recording your performance.

For details on selecting a song, see page 103.

If you want to overwrite an existing song already containing performance data, you will need to delete it beforehand.

3 Press the [SONG] button at the top right of the display to call up the SONG Page, then select the [●] (Record) button.

The following display appears, indicating that you can record your performance.

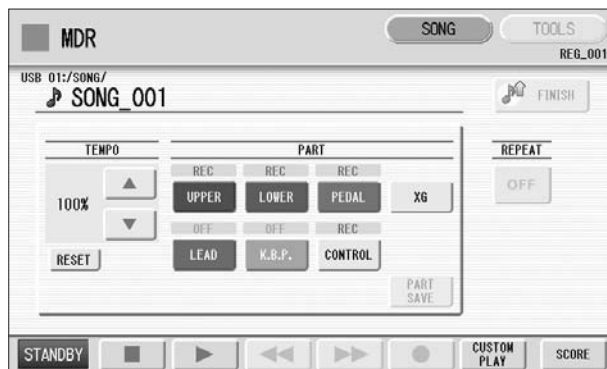

4 Press the [▶] (Play) button.

An hourglass icon appears at the bottom left of the display, indicating that Registration data is currently being read.

5 After the hourglass disappears, begin playing.

6 When you finish playing, press the [■] (Stop) button in the display.

The recording is finished and the LCD returns to the M.D.R. display. The song to which your performance is recorded is automatically named "SONG_XXX" (XXX indicates song number). You can change the song name as desired. (For details, see page 108.)



Never attempt to eject the media or turn the power off during recording, reading and playing back.



NOTE

If a message appears indicating there is not enough free space in media, press the [CANCEL] button, then press the [■] (Stop) button to go back to the M.D.R. display. Delete any unnecessary songs if possible or insert new media. To continue recording your performance on media that does not have enough space, press the [CONTINUE] button.



Do not remove the media from the Electone while data is being recorded (while the hourglass icon or other message is shown).

Re-recording (Retry)

If you make a mistake during recording, you can re-record the song from the beginning.

- 1 **Press the [●] (Record) button while the song is still running.**
This automatically stops recording and returns you to the starting point of the song.

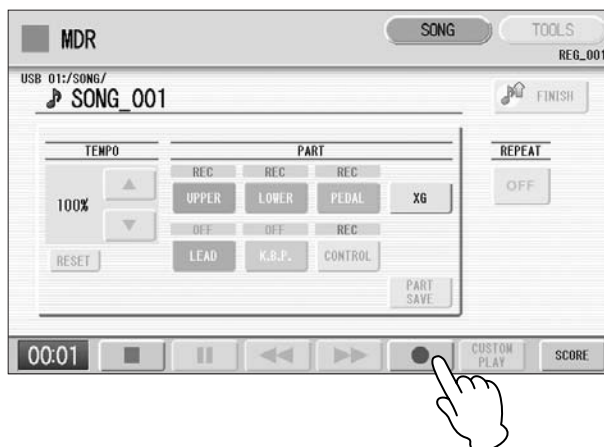

NOTE

Pressing the [■] (Stop) button cancels the re-recording and records the previous performance.

- 2 **Press the [►] (Play) or [CUSTOM PLAY] button to begin re-recording the song.**

Re-recording starts from the beginning of the song and replaces the previously recorded performance with the newly recorded performance.

Recording each part separately

You can also record the parts of your performance independently. This function lets you record Keyboard Percussion and performance control data, such as Registration changes and expression pedal operation, separately from the other parts of the song. Even Keyboard Percussion and Lead Voice 1 Voices can be recorded separately, though, the Lead Voice 2 Voices will be included in the performance data of the Upper Keyboard. The following instruction is an example: First, record the chords and bass to the song using the Lower and Pedalboard, and then record the melody using the Upper Keyboard.

- 1 **Follow steps 1 – 3 on page 105 to call up the Rec Standby display.**

- 2 **Select the parts for recording.**

Each pressing of a part button switches the status: PLAY, OFF, and REC.

PLAY: Playback the parts that have been recorded.

OFF: Recording or playback is not active.

REC: Records the part.



NOTE

When you record the Keyboard Percussion, make sure that the KEYBOARD PERCUSSION [1] and/or [2] button is set to on.

If you set the Upper part to “REC,” the performance on the Upper Keyboard (including Lead Voice 1 Voices) is recorded. Setting Lead to “REC,” however, records only the Lead Voice 1 Voices. You cannot set both Upper and Lead to “REC” at the same time; neither can the Lower and Keyboard Percussion parts be recorded at the same time.

The following setting lets you record only Lower Keyboard and Pedalboard parts.

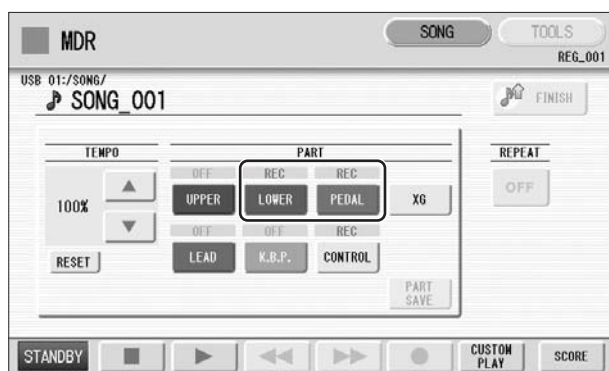

NOTE

You should also set the Control button to “REC,” in order to record Registration changes and expression pedal operation.

3 Press the [▶] (Play) button, and start playing after the hourglass icon disappears.

4 Press the [■] (Stop) button when you are finished with your performance to stop recording.

Now you’ve recorded the first parts of your performance.

5 Press the [●] (Record) button to set up recording of the next part—Upper part in this case.

A message appears prompting confirmation of operation. Select [OVERWRITE] to overwrite and the Rec Standby display appears.

6 Select the parts for recording.

Set the next parts you want to record (in this case, the Upper part) to “REC.” Also set the part already recorded (in this case Lower and Pedal parts) to “PLAY,” so you can hear the previously recorded parts as you record new ones.

7 Change the playback tempo for the selected part.

The playback tempo can be set over a range of 50% to 200% of the original. The original recorded tempo is 100%; values less than 100% result in a slower tempo while values greater than 100% result in a faster tempo.

8 Press the [CUSTOM PLAY] button to start recording of the new part or parts (Upper part).

Playback of the previously recorded parts starts immediately. The [CUSTOM PLAY] button is used here to record only the parts that have been selected for recording, and plays back only those parts that have been selected for playback. While you listen to the parts being played back, start playing the melody on the Upper Keyboard.

When the end of the recorded performance is reached, playback is automatically stopped. The length of a subsequently recorded part cannot exceed the length of the previously recorded parts.



NOTE

Use the TEMPO [RESET] button in the display to reset the tempo to its original value (100%).

Punch-in Recording

This lets you re-record a specific phrase or section which you don't want to use, either that of a specific part(s) or all parts.



NOTE

This function is best used when the phrase to be re-recorded has definite beginning and end points, with slight pauses before and after.

- 1 Select the song which contains the phrase you want to change.**
For details on selecting a song, see page 103.
- 2 Press the [▶] (Play) button to start playback of the song.**
- 3 Press the [■] (Pause) button at the point you want to execute punch-in recording.**
- 4 Press the [●] (Record) button.**
The recording display appears, indicating that the Music Data Recorder is ready to record.
- 5 Set the parts which you want to change to “REC” status and other parts to “PLAY.”**
- 6 Press the [▶] (Play) button to start punch-in recording. Play the new phrase, as you want it to be changed.**
- 7 Press the [■] (Stop) button to quit the punch-in recording as soon as you reach the end of the phrase.**

6 Changing the Song Name



NOTE

When you change the name of an XG song, the extension (.mid) cannot be changed.

You can name the song, such as giving it a title or indicating the date on which it was recorded. However, song names of the EL-series Electone, such as the EL-900, cannot be changed.

- 1 Select the song whose name you want to change.**
For details on selecting a song, see page 103.
- 2 Press the [TOOLS] button at the top right of the display to call up the TOOLS Page.**

3 Press the [CHANGE NAME] button.

The following display appears.

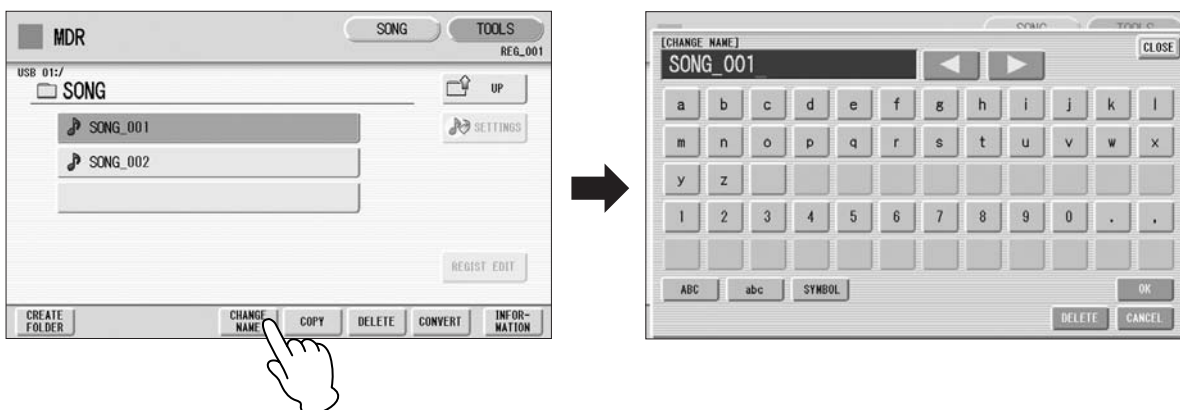

4 Move the cursor to the desired point by using the [◀] [▶] buttons in the display or the Data Control dial.

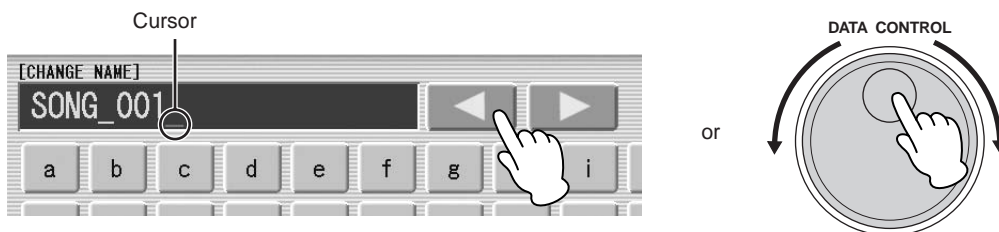

5 Select the desired character type: alphabet, upper or lowercase, or symbol.

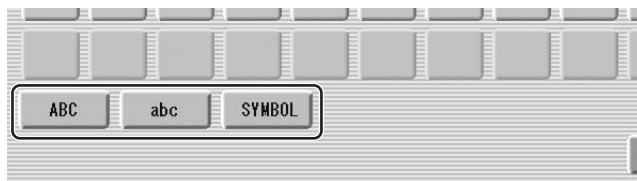

NOTE

If you select Japanese as the Language in the Utility display, you can also select Japanese language characters (hiragana and kanji, normal size katakana, half size katakana, full size alphabet, and full size symbols).

6 Select the desired character for entry.

A song name can contain up to 50 characters.



NOTE

An XG song name can contain up to 46 characters.

7 After finished, select [OK] to actually enter the name.

The LCD will return to the TOOLS Page display.



To delete the entered character:

- 1 Move the cursor to the character you want to delete.

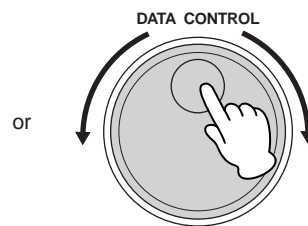

- 2 Press the [DELETE] button at the bottom right in the display.
The character is deleted.



To convert into kanji (Japanese language):

This applies only if you are using the **かな漢** (Kana-Kan) button in Japanese.

- 1 When the input “Hiragana” characters are shown in the reverse display (highlighted), press the **漢字変換** (kanji-conversion) button once or several times to convert to the characters into the appropriate kanji.

- The reversed area can be changed by the [◀] [▶] buttons in the display or the Data Control dial.
- The converted area can be cleared at once by pressing the **キャンセル** (cancel) button.

- 2 To actually enter the change, press the [OK] button or enter the next character. To enter the hiragana character itself (without converting it), press the **削除** (delete) button.

A “name is not available” message may appear when you press the [OK] button to finish entering the name. If this message appears, the name is invalid and you should enter another name.

The following names cannot be used. (“xx” indicates numbers.)

MDR_xx.EVT	ELS_SONG.NAM	MDR_xxx.TMP	TMP
MDR_xx.MID	MDR_xxx.MID	REG_xxx.TMP	TMPE02
MDR_xx.Bxx	REG_xxx.B00	ELS_SONG.TMP	
MDR_xx.Vxx	SONG_xxx	SONG_xxx.C02	
SONG.NAM			



NOTE

Songs are ordered in the following sequence: symbol, number, alphabet, hiragana, kanji, other symbols. Names with an asterisk (*) at the top are exceptions to this rule.

7 Saving Registrations as Registration Data (File)

You can also record Registrations by themselves, without recording a performance. Bulk data, including Registration Memory and Registration Shift settings, Rhythm Patterns (User rhythms) Rhythm Sequence data, and User Voices, are also saved in the operation.

1 First create your original settings you want to save then select the destination (blank song).

For details on selecting a song, see page 103.

2 Press the [REGIST EDIT] button in the display to call up the Regist (Registration) Edit Display.

3 Press the [SAVE] button in the display.

A message appears, indicating the Registration data is currently being saved. After the message disappears, exit from the Regist (Registration) Edit Display by pressing the [CLOSE] button and return to the SONG SELECT Page. The song to which the Registration is recorded is automatically named "SONG XXX" (XXX indicates song number).

Saving Two or More Registration Banks to One Song

When you want to use more than 16 Registration numbers, you can save additional Registration banks to a single song, with the following procedure.



Reference Page

Next Regist (page 88)
Programming a Registration
Sequence (page 179)

1 First create the original settings you want to save, then select the destination song.

For details on selecting a song, see page 103.

2 Press the [REGIST EDIT] button in the display to call up the Regist (Registration) Edit Display.

The Registration data which has previously been saved to the song is shown.

3 Press the lowest blank (empty) Registration button.

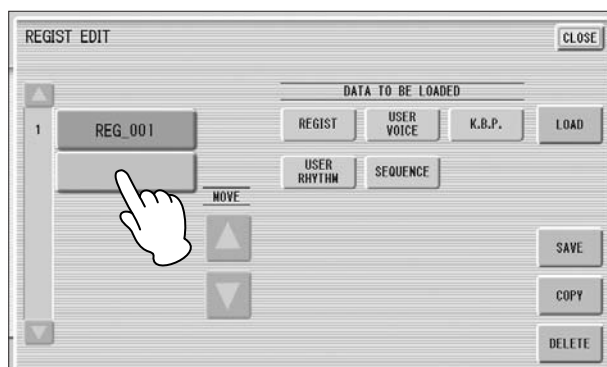

4 Press the [SAVE] button.

The Registration data will be added.

When you play back this song, the top Registration bank in this display will be loaded to the Electone. You can also change the order of the Registration bank. See page 113.

Replacing Registrations

The M.D.R. also lets you change the Registrations of an existing song without changing the performance data. In advance, you need to create the original Registration that will replace the old one.

1 Select the song for which you wish to replace the Registrations.

For details on selecting a song, see page 103.

2 Press the [REGIST EDIT] button in the display to call up the Regist (Registration) Edit Display.

The Registration bank which has been saved to the song is shown.

3 Select the Registration bank you wish to replace.

4 Press the [SAVE] button.

A message appears, prompting confirmation of overwriting the Registration bank. Select [OVERWRITE] to overwrite (replace), or select [CANCEL] to abort the operation.

Next Regist (Registration) Settings (Changing the order of the Registration data)

When playing back a song which uses more than 16 Registration numbers, you can use two or more Registration banks saved in a single song and recall them one by one as you play the song. This function is called Next Regist (Registration).

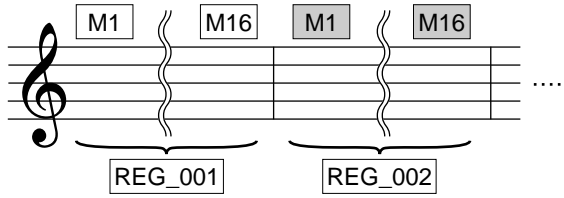

If you want to use the Next Regist (Registration) function, you'll have to make one of the following settings in advance:

- Set the Registration Shift mode to User, and select Next Regist (Registration) as the Shift End, in advance.
- Enter the Next Regist (Registration) data in the Registration Sequence.



NOTE

If the next Registration data contains User voices and/or VA custom voices, the Electone may produce no sound for a few seconds while the Registration is being loaded.

1 Save the desired Registrations to a song.

For instructions on saving two or more Registration banks to a song, see page 111.

2 Select the song containing the Registrations for which you want to change the order.

For details on selecting a song, see page 103.

3 Press the [REGIST EDIT] button in the SONG Page to call up the Regist (Registration) Edit Display.

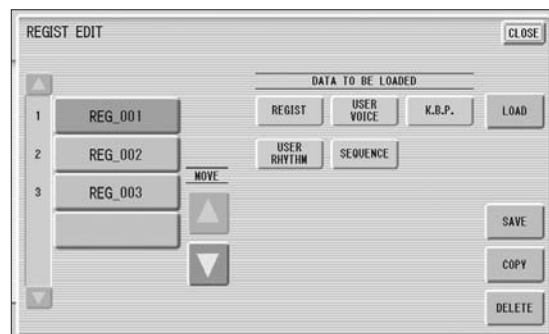
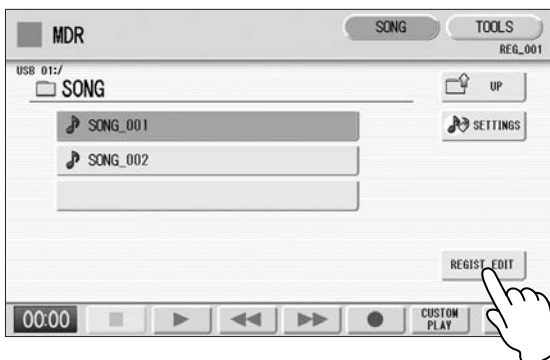

4 Change the Registration order, in the order you want to recall.

First select the specific Registration bank you want to edit, then move, copy or delete the selected data as needed to change the order.



NOTE

If the Next Regist (Registration) function is used while the rhythm is being played back, the sequence data and User rhythm will not change.

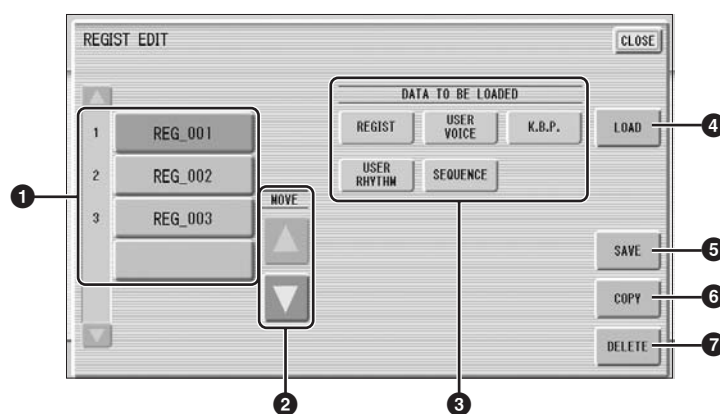

1 Registration Data List

From this list, select the Registration you want to move, copy or delete. The selected Registration is highlighted in orange. When more than five Registration banks are saved in the song, a scroll button  is available for scrolling through the Registration Data List.

2 MOVE

Moves the selected Registration bank up or down.

3 DATA TO BE LOADED

When loading the Registration bank to the panel, select the desired data you want to load. For more information, see page 115.

4 LOAD

Loads the selected Registration bank to the panel/keyboards. After loading, press one of the Registration Memory button and play the keyboard to check the Registration.

5 SAVE

Saves the current panel settings as a Registration bank in the song. The currently selected Registration in the Registration Data List (1) will become the destination location.

6 COPY

Copies the currently selected Registration to the lowest blank location in the Registration Data List.

7 DELETE

Deletes the currently selected Registration bank in the Registration Data List.

5 Exit from the Regist (Registration) Edit Display by pressing the [CLOSE] button at the top right of the display.

8 Recalling Recorded Registrations

Registrations (and bulk data) recorded to song numbers can be easily loaded back to the Electone by the following procedure. The M.D.R. independently recalls the following five types of data:

- REGIST
- USER VOICE
- K.B.P.
- USER RHYTHM
- SEQUENCE

You can select and recall the desired data independently.

1 Insert the appropriate media and select the song you want to load back to the Electone.

For details on selecting a song, see page 103.

2 Press [REGIST EDIT] button in the display to call up the Regist (Registration) Edit Display.

3 Select the Registration you want to load to the Electone.

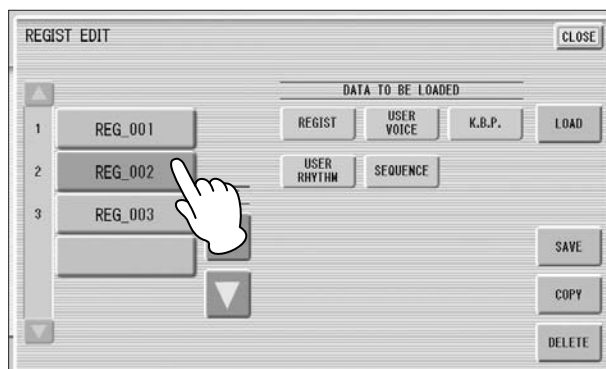

4 Using the five “DATA TO BE LOADED” buttons, select the desired data you want to load.

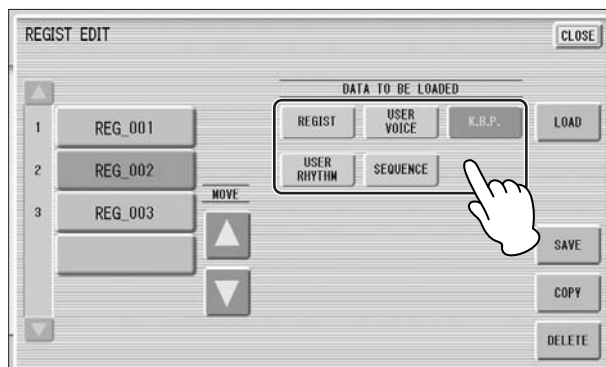

NOTE

When you load the Registration data by using the Next Regist function, all data will be loaded no matter which buttons you select here.



NOTE

If you load a Registration while a rhythm is playing, sequence data and User rhythms in the Registration data cannot be loaded.

5 Press the [LOAD] button.

A message appears, prompting confirmation of the operation. Press the [LOAD] button to load the Registration data. Press [CANCEL] to cancel the operation.

6 Exit from the Regist (Registration) Edit Display by pressing the [CLOSE] button at the top right of the display.

When you select the protected song, the buttons (DATA TO BE LOADED) may be unavailable (grayed out). For example, combining a part of one protected song with another protected song is not allowed.

About Protected Songs

If you buy or download the song data, it may be protected so that you cannot delete or copy, in order to prevent accidental erasure or protect copyright. This is "Protected Song." Protected songs can be saved to a USB flash memory confirmed by Yamaha.

The protected song can be played back as well as the song you created, but it cannot be converted to XG format, or EL format. It is not possible to edit the Registration data in the protected song, nor to overwrite the performance data.

If you want to edit the protected song, first copy it within one media/folder, then edit the copy. (You cannot copy to another media/folder.) The copy song (called "protected edit song") is available only when the original song (called "protected original song") exists in the same folder. Be careful not to delete the protected original song.

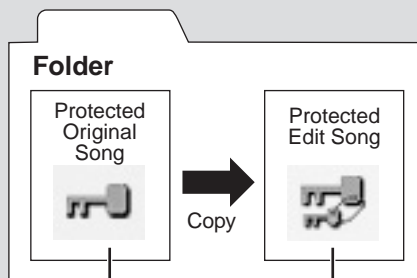

You cannot edit this song

You can edit this song, only when this is in the folder that contains protected original song.



To move the protected song in a USB flash memory with a computer, you'll need to use the Musicsoft Downloader application. If you move the song without Musicsoft Downloader, the song cannot be played back. Musicsoft Downloader can be obtained at the following Internet address: <http://music.yamaha.com/download/>



When you want to edit a protected song, first initialize the Registration Memory (page 85), then select the desired song. If you have not initialized the Registration first, the edited song may not be saved.

9 Playing Back a Song

The M.D.R. enables you to play back commercially available XG-compatible song data and MIDI data created with a computer as well as songs recorded on the Electone itself.

1 Select the song to be played back.

For details on selecting a song, see page 103.

2 Press the [▶] (Play) button in the display to load the Registration data.

An hourglass icon appears, indicating the Registration data is loading.

If the song contains more than two Registration banks, the first one will be loaded. You can check the Registration order in the Regist (Registration) Edit Display.

If the song contains no performance data, after loading the Registration data, the LCD returns to the SONG Page.

3 Playback starts automatically after reading the Registration data (the elapsed time is shown).

In general, all parts recorded to the song are played back; however, you can mute specific parts and playback only selected parts. For more information, see page 118.

When the end of the recorded performance is reached, playback automatically stops. You can, however, stop playback in the middle of the song by pressing the [■] (Stop) button in the display.



Reference Page

Next Regist Settings
(Changing the order of the
Registration data) (page
113)



Reference Page

About the [SETTINGS]
button (page 104)

Custom Play

If you want to play back the song without resetting the Registrations, press the [CUSTOM PLAY] button instead of the [▶] (Play) button. This displays the song time and starts playback immediately.



When you play the song using the Next Regist function, always press the [▶] (Play) button to start the song, not the [CUSTOM PLAY] button.

Playing Back the Selected Part(s)

You can also play back selected parts of your recorded performance, while other parts are temporarily turned off. This function is especially useful for playing a single part, such as the melody, over previously recorded accompaniment parts.



Reference Page

Setting a song (page 104)

To play back the selected part(s):

During playback or in the Settings Display, press each part button to turn the part you want to playback to “PLAY” and the part you want to mute to “OFF.” Each pressing of a part button switches the status between PLAY and OFF. Pressing the [PART SAVE] button saves each part’s playback status.

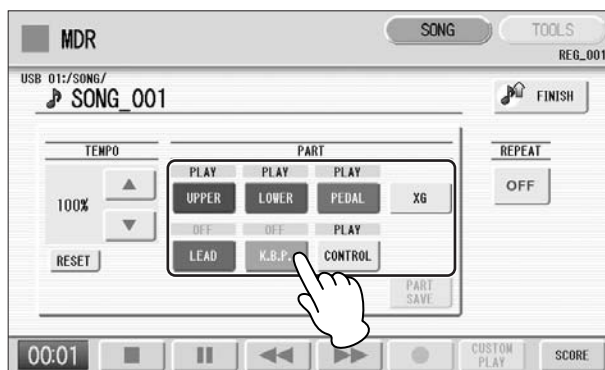

Reference Page

Converting to XG (page 128)

To play back the selected part(s) of XG-compatible song data:

Press the Part [XG] button while XG-compatible song data is being played back. The following XG Part Setup Display appears.

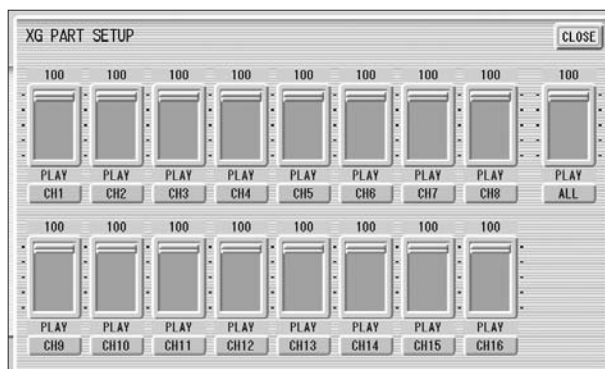

Press the appropriate channel buttons (e.g., the [CH1] button) to set each channel to playback or mute. Each pressing of a button switches the status: PLAY and OFF. Set a part to [PLAY] if you want to play it back and [OFF] if you do not. The [ALL] button enables you to switch all channels to PLAY/OFF at once.

To set each channel’s volume use the sliders. Each channel’s volume can be adjusted between 0 and 100.

The [ALL] slider adjusts the overall volume.

Fast Forward, Rewind and Pause

Fast Forward and Rewind:

During playback, press the [▶▶] (Fast forward) button or [◀◀] (Rewind) button and hold it down until the time reaches the desired position.

Even when the button is released, playback is paused. To resume playback from the point you've advanced or reversed to, press the [▶] (Play) button or [CUSTOM PLAY] button.

Pause:

If you want to temporarily stop playback of the song or songs, press the [■] (Pause) button.

To resume playback from the point at which the song was paused, press the [▶] (Play) button or [CUSTOM PLAY] button.

Changing the Tempo

You can change the tempo of the song as the song is playing in the M.D.R. display, either while the song is stopped or while it is playing.

To Change the Tempo:

Use the TEMPO ▲ ▼ buttons in the display or Data Control dial to change the tempo. (The TEMPO dial on the panel cannot be used to change the tempo for the Music Data Recorder.) The range is 50 – 200%. The original recorded tempo is 100% and values less than 100% indicate slower tempo; values greater than 100% indicate faster tempo.

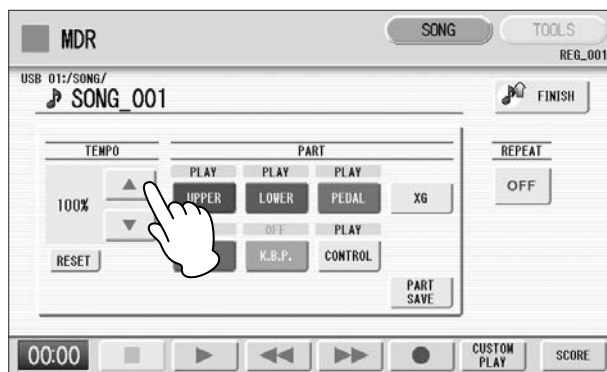

To reset the changed tempo:

Use the TEMPO [RESET] button in the display to reset the tempo to its original value (100%).

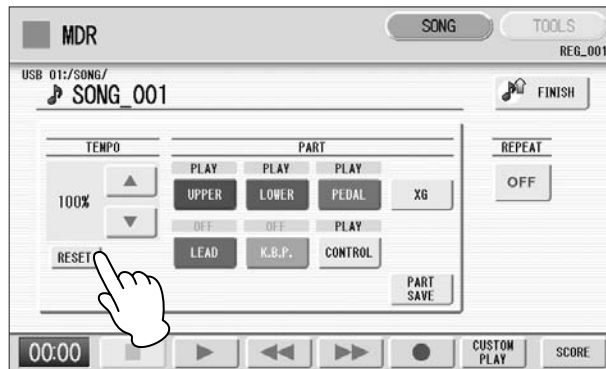

Repeat Playback

This feature allows you to repeatedly play back either all songs on a folder or only one specific song.

- 1 Select the song you wish to play back.**
If you wish to play back all songs on a folder, select the first song that will be played back. For details on selecting a song, see page 103.
- 2 Press the [SONG] button at the top right of the display to call up the SONG Page.**
- 3 Press the  button on the panel to call up the Settings Display.**

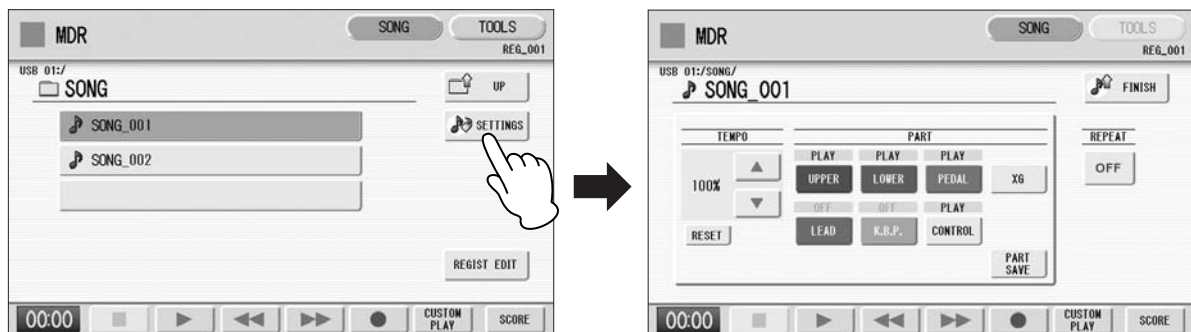

4 Press the REPEAT button to select the repeat mode.

Each press of the button switches the mode.

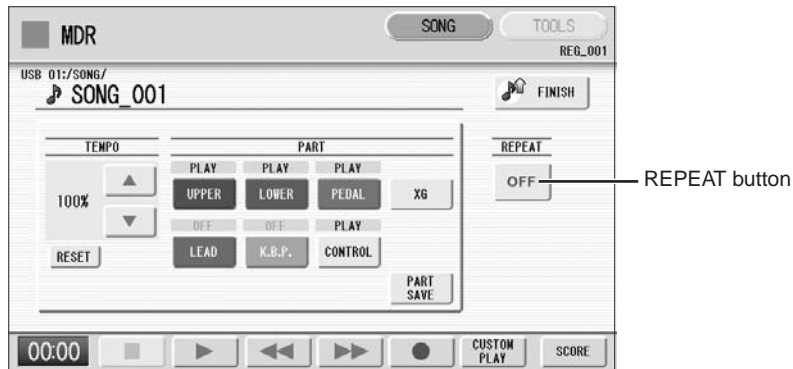

SINGLE

Repeats the currently selected song again and again.

ALL

Repeats all songs in the currently selected folder in order.

RANDOM

Repeats all songs in the currently selected folder randomly.

OFF

Cancels repeat playback.

5 Exit from the Settings Display by pressing the button at the top right of the display.

6 Press the [▶] (Play) button in the SONG Page to begin playback.

10 Displaying the Score

The M.D.R. display can display a music notation (score) of the performance data recorded to media. You can change the size and the number of staves to be displayed. While a song is being played back, the cursor moves according to the performance and the pages are automatically turned.

1 Select the song containing performance data.

For details on selecting a song, see page 103.

2 Press the [SCORE] button in the display.

The currently selected song score will be displayed.

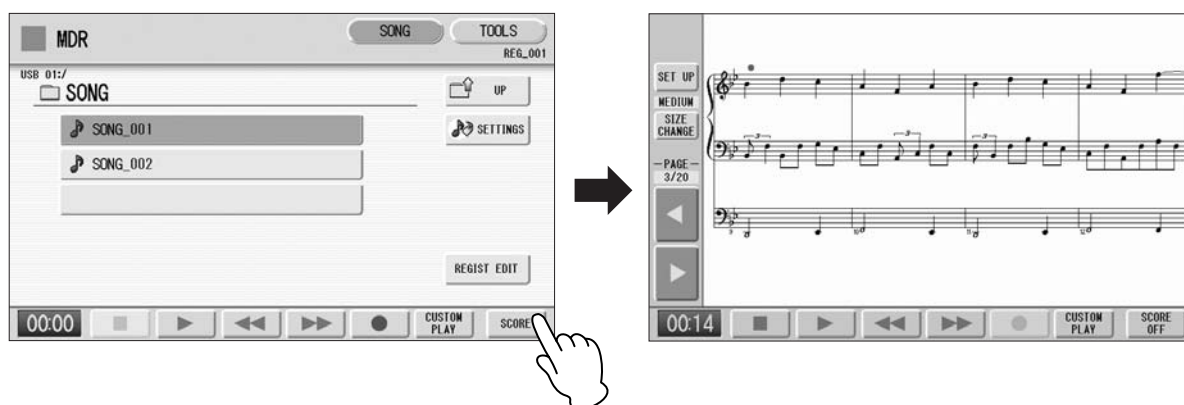

NOTE

The score size setting cannot be stored to a Registration Memory.



NOTE

Scores for protected songs cannot be displayed, excepting those songs that specifically allow score display.

3 Press the [▶] (Play) button in the display to start playing back the song.

As the song plays back, the cursor moves accordingly and the page is automatically turned at the appropriate point.

In this condition, pressing the [●] (Record) button in the display lets you record a song and have the score displayed for you.

The score size can be adjusted by pressing the [SIZE CHANGE] button in the display. Each press of the [SIZE CHANGE] button alternates the score size in the following sequence: normal, large, extra large, small, normal, and so on. Please note that the size cannot be changed while a song is being recorded.

4 You can manually turn the page, by stopping playing back a song using the [■] (Stop) or [||] (Pause) button, and then pressing the PAGE [◀] or [▶] buttons in the display.

Pressing these buttons moves to the previous or next page. The PAGE [▶] button can be assigned to the left foot switch (page 123).

5 To exit the score, press the [SCORE OFF] button in the display.

Changing the score contents and settings

The Score Settings Display lets you choose the contents to be displayed. In this display, you can also assign the Next Page function to the left foot switch:

- 1 Display the score.
- 2 Press the [SET UP] button in the display to call up the Score Settings Display.

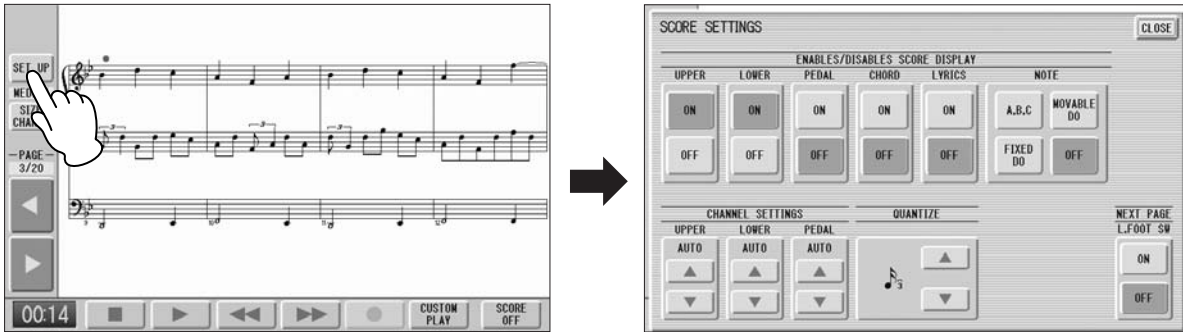

NOTE

Please note that the score settings cannot be changed while the song is being recorded. The [SET UP] button is disabled during recording.

- 3 Change the score settings.

To set whether a specific part is displayed or not in the score, press the appropriate [ON] or [OFF] buttons of each part. Please note that at least one of the upper keyboard, lower keyboard or pedalboard will be set to [ON].

Available settings for notes and how they will be displayed (NOTE) include [A, B, C] (conventional C-D-E indications), [FIXED DO] (solfeggio), [MOVABLE DO] (relative solfeggio) and [OFF].

For the CH SETTINGS, the upper keyboard, lower keyboard and pedalboard can be assigned to the channels with the [▲] or [▼] button. You can also use the Data Control dial to select channels after pressing the [▲] or [▼] button. Selecting [AUTO] automatically assigns parts to the channels according to the song data.

To set the QUANTIZE value use the [▲] or [▼] button. You can also use the Data Control dial to select channels after pressing the [▲] or [▼] button. The shorter the note value is selected, the more precisely the score is displayed.

Setting the NEXT PAGE L. Foot SW [ON] lets you turn the score to the next page with the left foot switch. You can also turn the score to the next page with the PAGE [▶] button in the display. If rhythm, glide and/or rotary speaker are assigned to the left foot switch and set on, both the assigned functions and the Next Page function work.

- 4 Exit from the Score Settings Display by pressing the [CLOSE] button at the top right of the display.



NOTE

The score display settings cannot be stored to a Registration Memory. Only the left foot switch setting can be stored to USB flash memory as Registration data common to all Registration Memory numbers.



NOTE

Setting the NOTE to [MOVABLE DO] displays each key note as "Do."



Reference Page

About Quantize (page 156)

11 Other Functions (Tools)

The TOOLS Page in the M.D.R. display has many functions, such as song copy, song delete, etc.

Song Copy

This function lets you copy data recorded in one song to another song. You can copy and exchange the data even between two different media. (Only songs created with the ELS-01/01C can be copied. Songs created with the EL-series, such as the EL-900, cannot be copied.) Make sure to check the remaining memory of the destination media in advance. If memory space is insufficient, or if the folder already contains 100 songs, Song Copy is not available.

Moving a Protected Song

A protected song can be copied within a folder, but it cannot be copied to another folder or media. If you specify another folder or media as the copy destination, a message appears prompting moving of the song—not copying. When the [MOVE] button is pressed, the protected original song and all protected edit songs which come from the same protected original song will be moved together. This effectively “moves” a protected song, but does not “copy” it.

To copy a song:

Insert the media that contains a song to be copied and the destination media.

- **To copy within one media**
Insert the media that contains a song to be copied.
- **To copy a song from USB flash memory to another**
Insert both the USB flash memory that contains a song to be copied and the destination USB flash memory. When there are not enough terminals available, use a self powered USB hub. If you don't have a USB hub, you can copy a song by following the procedure on page 125.

1 Select the song to be copied.
For details on selecting a song, see page 103.

2 Press the [TOOLS] button at the top right of the display to call up the TOOLS Page.

3 Press the [COPY] button in the display to call up the Copy To Display.

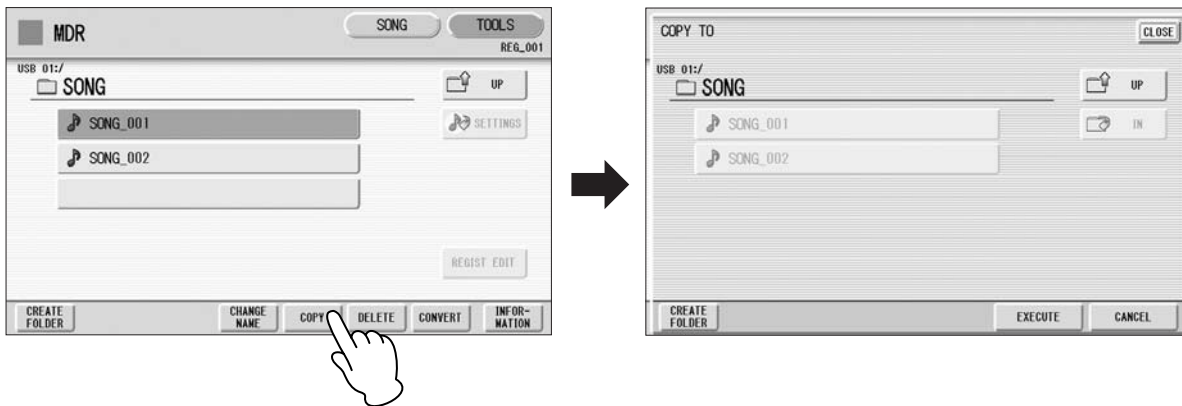

4 (If necessary) Change the destination.
For details on changing the destination, see page 103.

5 Press the [EXECUTE] button to execute the copy.
The song name in the destination is the same as the one of the source song. If you copy a song to a folder that contains a song whose name is the same as the source song, the copied song name will be “source song name_XXX” (XXX indicates song number). If you want to change the song name, see page 108. If you copy an XG-compatible song to another folder or media that contains a song with the same name as the source song, a message appears prompting confirmation of overwriting the song. Selecting [OVERWRITE] overwrites the XG-compatible song in the destination.



Never attempt to eject the media or turn the power off during copying (or moving a protected song). Data may be lost.



NOTE

If you copy a protected song to the same folder as the source song, the copied song will be the protected edit song.

To copy a song from USB flash memory to another:

It is recommended that you use connect both media (source and destination) to the USB TO DEVICE terminal. However, if there are not enough terminals available, you can copy a song by following the procedure below.

- 1** Follow the step 1 – 3 on page 124.
- 2** Press the  button several times until the Media List is displayed.
- 3** Select “MEMORY” as the destination.

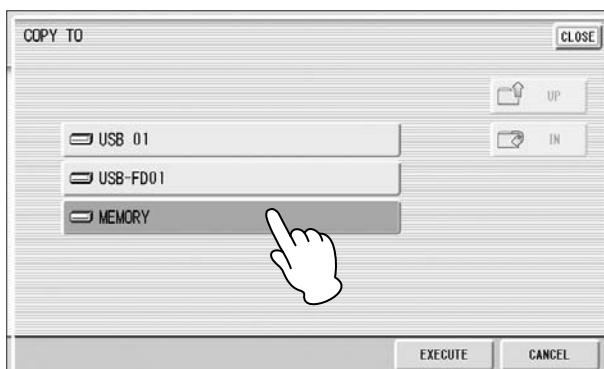

Removing the media during operation may result in loss of the data. Never attempt to remove the media unless the “Eject the source media” message appears.

**NOTE**

If you want to abort the operation, press the [CANCEL] button.



Never attempt to turn the power off during copying a protected song. Data may be lost.

4 Press the [EXECUTE] button to execute the Song Copy.

The song to be copied is copied to the internal memory of the Electone. The message “Eject the source media” will appear on the display.

5 Eject the source media.

After ejecting the source media, the message “Insert the destination media” will appear on the display.

6 Insert the destination media to which you want to copy.**7 Select the destination.**

For details on specifying the destination, see page 103.

8 Press the [EXECUTE] button to execute Song Copy. Select [OVERWRITE] to execute or [CANCEL] to abort the operation.

The song is copied with the same name as the source song. If you copy a song to a folder that contains a song whose name is the same as the source song, the copied song name will be “source song name_XXX” (XXX indicates song number).

If you copy an XG-compatible song to another folder or media that contains a song with the same name as the source song, a message appears prompting confirmation of overwriting the song. Selecting [OVERWRITE] overwrites the XG-compatible song in the destination.

If you want to change the song name, see page 108.

Song Delete

You can delete the data of one song. You can specify for deletion only Registration data, only the performance data, or both of them (entire song). Also, only the songs created on the ELS-01/01C and XG-compatible songs can be deleted. Songs created on the EL series instruments such as the EL-900 cannot be deleted.

1 Select the song to be deleted.

For details on selecting a song, see page 103.

2 Press the [TOOLS] button at the top right of the display to call up the TOOLS Page.**3 Press the [DELETE] button in the display.**

A message appears, prompting confirmation of the operation.

Confirm that the song to be deleted is shown in the display. If you want to change the song, press the [CANCEL] button and select the desired song.

- 4 Press the button of the specific data you want to delete (“DELETE ALL,” “DELETE REGIST” or “DELETE PERFORMANCE”). The selected data will be deleted.

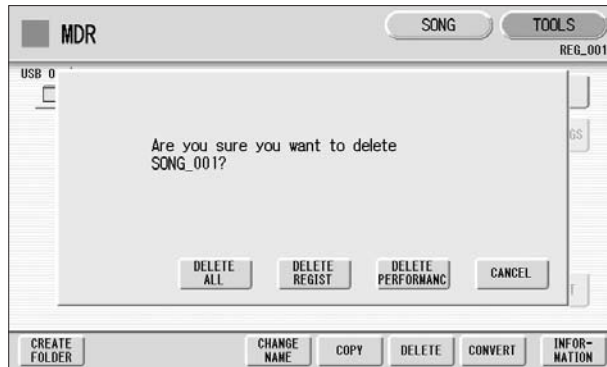

- **DELETE ALL:** Deletes the entire song.
- **DELETE REGIST:** Deletes only Registration data in the song.
- **DELETE PERFORMANCE:** Deletes only performance data in the song.

Pressing [CANCEL] aborts the operation.

When deleting folders, songs with only registration, songs with only performance data, protected songs or XG-compatible songs:

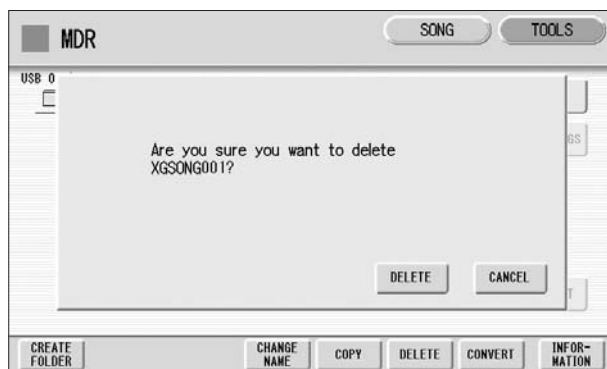

Select [DELETE] to actually delete the data, or select [CANCEL] to abort the operation.

Converting to XG

This function allows you to convert the ELS-01/01C song data to XG format data. You can playback the data using XG devices. The converted XG song data may sound differently from the original data.

Confirm that the media should contain enough amount of available memory before the conversion. The protected songs cannot be converted to XG format.

1 Select a song to be converted to XG.

For details on selecting a song, see page 103.

2 Press the [TOOLS] button at the top right of the display to call up the TOOLS Page.

3 Press the [CONVERT] button.

A message “Which do you want to select?” appears.

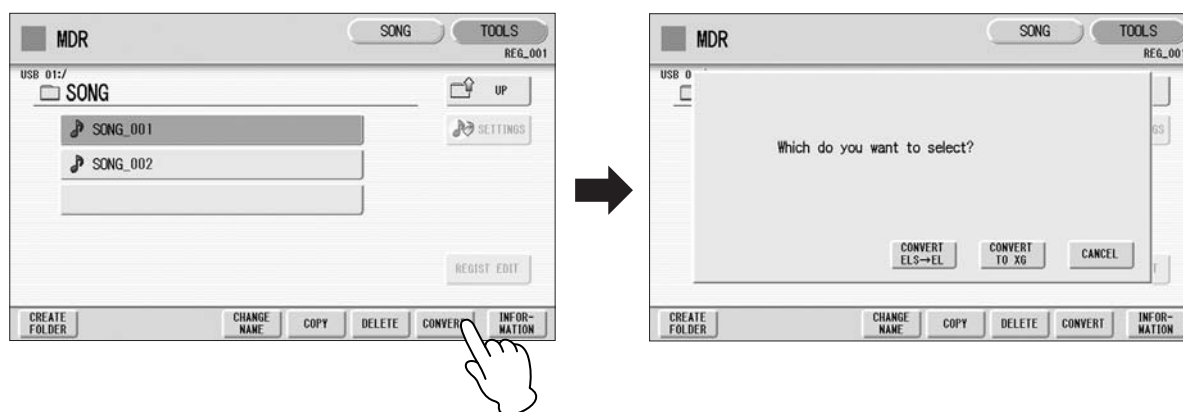

4 Press the [CONVERT TO XG] button.

The following display appears.

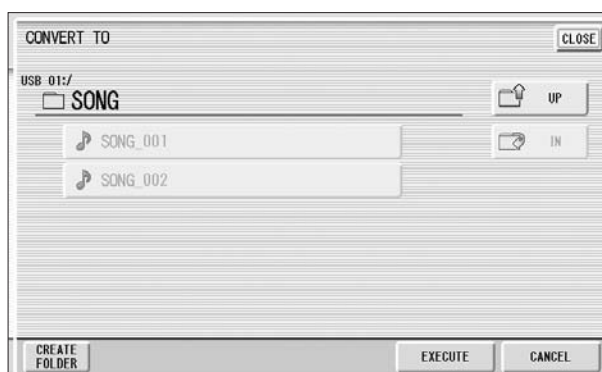

5 (If necessary) Changes the destination to save the converted song.

For details on changing the destination, see page 103.

6 Press the [EXECUTE] button.

A message appears indicating that the converted data is being checked and the M.D.R. starts playback of the selected song. When playback is finished, the display returns to the previous display.



NOTE

Playing the keyboard or pressing the panel controls during the confirmation of the conversion will be recorded to the converted XG-compatible song.

Converting ELS format to EL

You can convert songs created on the ELS-01/01C to EL-series format, and save them to a floppy disk. The converted data can be used with EL-series Electones, such as the EL-900. This function is not available for protected songs.

You'll need to install the optional floppy disk drive such as UD-FD01.

1 Select the song to be converted to EL-series format.
For details on selecting a song, see page 103.

2 In the TOOLS Page, press the [CONVERT] button.
A "Which do you want to select?" message appears.

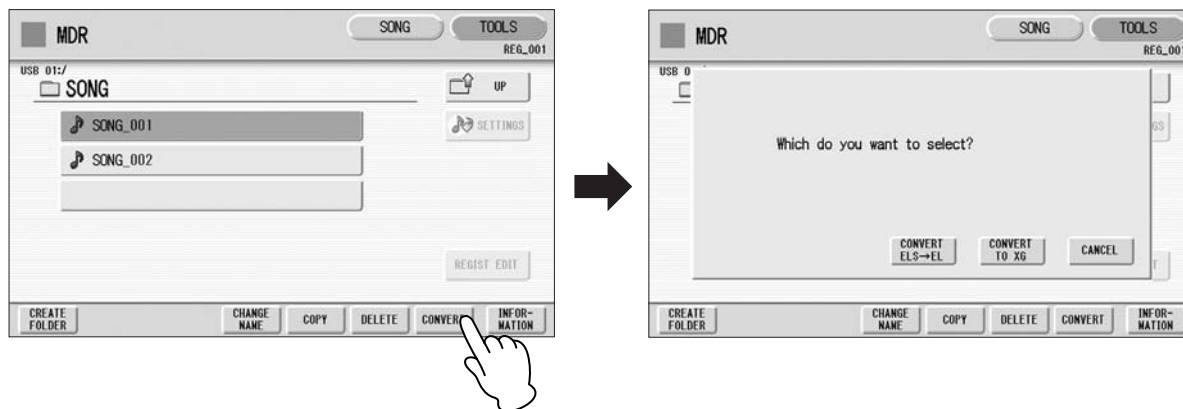

3 Press the [CONVERT ELS → EL] button.
If the source song contains two or more Registration banks, you'll need to make ready the same number of destination songs to save the converted data.

4 Insert the floppy disk, then press the [EXECUTE] button in the display.
If the remaining memory of the floppy disk is insufficient, conversion cannot be executed. (An error message appears and the operation is cancelled.)

 **Reference Page**

About Protected Songs (page 116)

 **NOTE**

User rhythms cannot be converted to EL format.

 **NOTE**

If the source song's name contains full size characters or Japanese characters, these characters will be shown as question marks (such as "????").

Converting EL format to ELS

You can convert the songs in the floppy disk created with an EL-series Electone, such as the EL-900, to the ELS-01/01C format, and save it to a USB flash memory confirmed by Yamaha. You'll need to install the optional floppy disk drive such as UD-FD01.

Depending on the original song, the sound or tempo of the converted song may differ from the original song, or the Next Song function of the original song may not be effective.

1 Insert the floppy disk that contains the song you want to convert to ELS format, then select the source song.
For details on selecting a song, see page 103.

 **Reference Page**

Installing the Floppy Disk Drive (page 224)

 **NOTE**

When you convert the protected EL data to ELS format, set the write-protect tab of the EL disk to the "overwrite" position (tab closed).

2 In the TOOLS Page, press the [CONVERT] button.

A message appears confirming if you want to convert from the EL format to the ELS format.

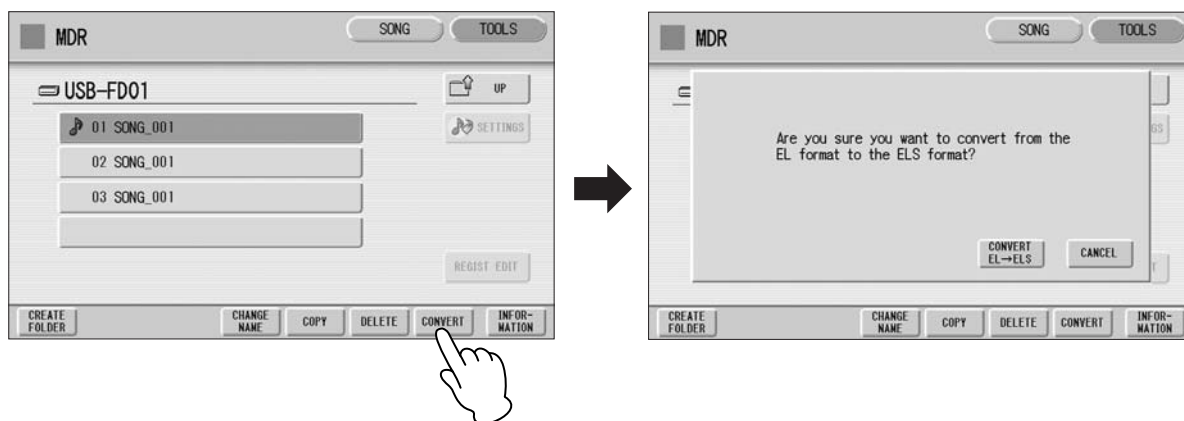

3 Press the [CONVERT EL → ELS] button in the display, then specify the destination for the converted song.

To use the converted song on the ELS-01/01C, the destination must be USB flash memory.

4 Press the [EXECUTE] button in the display to start conversion.

If the remaining memory of the USB flash memory is insufficient, conversion cannot be executed. (An error message appears and the operation is cancelled.)

Checking the Remaining Memory

In the TOOLS Page, press the [INFORMATION] button. If media is selected, the remaining memory in the media is shown and if a song is selected, the song data capacity, title, composer, etc. are shown.

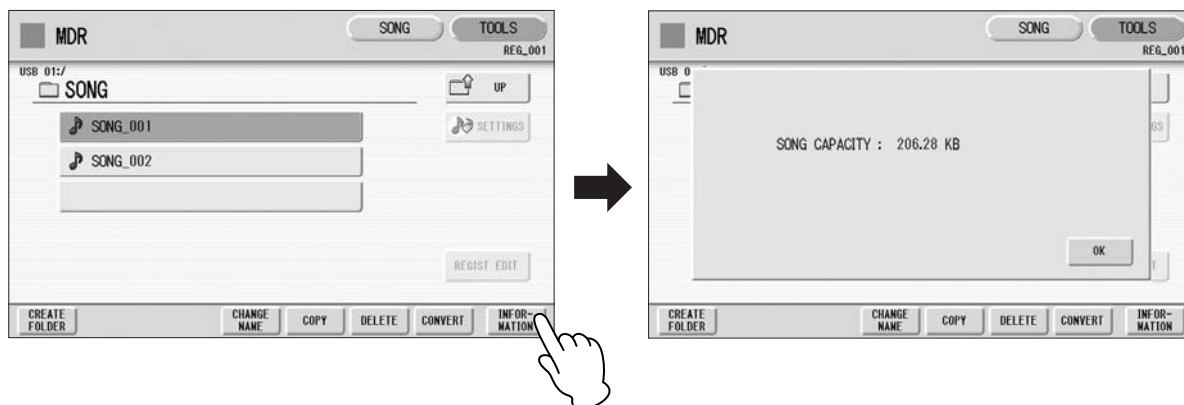

This Electone has a Voice Edit feature that allows you to create your own Voices. We suggest that you read through the Voice Structure below at first to get a firmer understanding of the Voices. Then go through the editing steps, reading *Editing a Voice* on page 134 for editing of an AWM Voice, or page 139 for editing of a VA Voice.

Contents	
1 Voice Structure	131
• AWM Voice structure	131
• VA Voice structure	132
2 Editing a Voice	132
• Selecting a Voice for editing	132
• Editing an AWM Voice	134
• Editing a VA Voice (only for ELS-01C)	139
3 Saving the edited Voice	141
4 Quitting Voice Edit	142
5 Recalling an Edited Voice	142

1 Voice Structure

The internal structure of the Voices of this Electone is explained below. Refer also to “AWM Voices and VA Voices” (page 34).

AWM Voice structure

AWM Voices consist of up to four recorded samples of a real instrument.

Each waveform, referred to as an “Element,” can be edited, by changing the level (volume), filter settings, and so on. A single Voice contains four boxes (AWM1 – AWM4) in which the Elements are put. If a Voice consists of less than three Elements, some boxes are empty. For example, Strings 1 consists of two Elements (as shown).

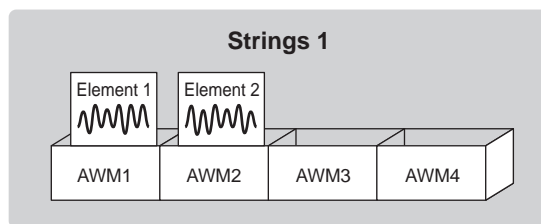

You can add Elements from other Voices – Brass, for example – if a box (AWM3 and/or AWM4) is empty. This allows you to create your own original ensemble sounds. In the Voice Edit function, you can edit not only each Element, but also assemble some Elements from other Voices.

VA Voice structure

VA Voices are made by simulating the characteristic behavior of acoustic instruments. You can edit the Voice's volume and timbre. Moreover, you can also add AWM Elements to a VA Voice to create your own original Voice.

VA Voices are available only on the Lead Voice 2 section of the ELS-01C. All Voices in the other Voice sections are AWM Voices.

2 Editing a Voice

Selecting a Voice for editing

1 Select the Voice you want to edit from the Voice Menu.

For example, if you want to edit Accordion 1, select [Accordion 1] in the Voice Menu of the [ORGAN] button in any Voice section.

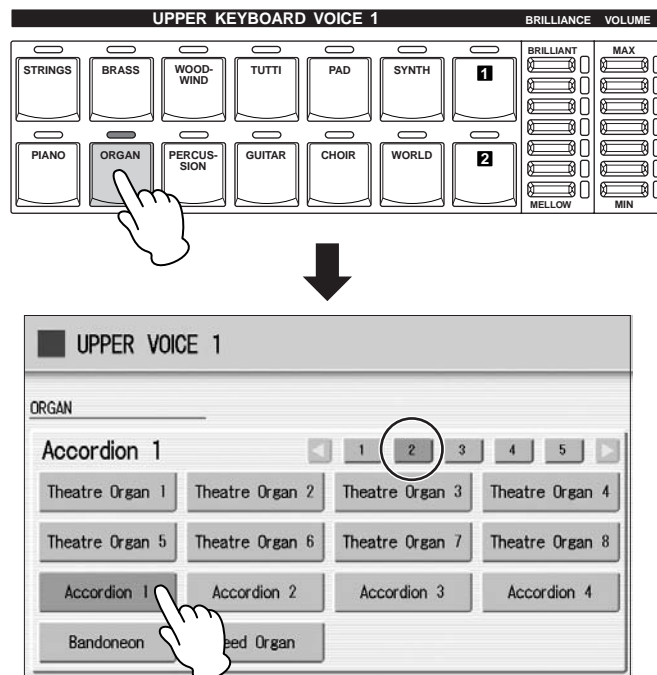

Mute all other Voice sections except for the targeted Voice section.

2 While holding down the [VOICE EDIT] button, press the Voice button corresponding to the Voice you wish to edit.

If you press [VOICE EDIT] without selecting a Voice, the following display will prompt you to complete the step. While this display appears, press the desired Voice button.

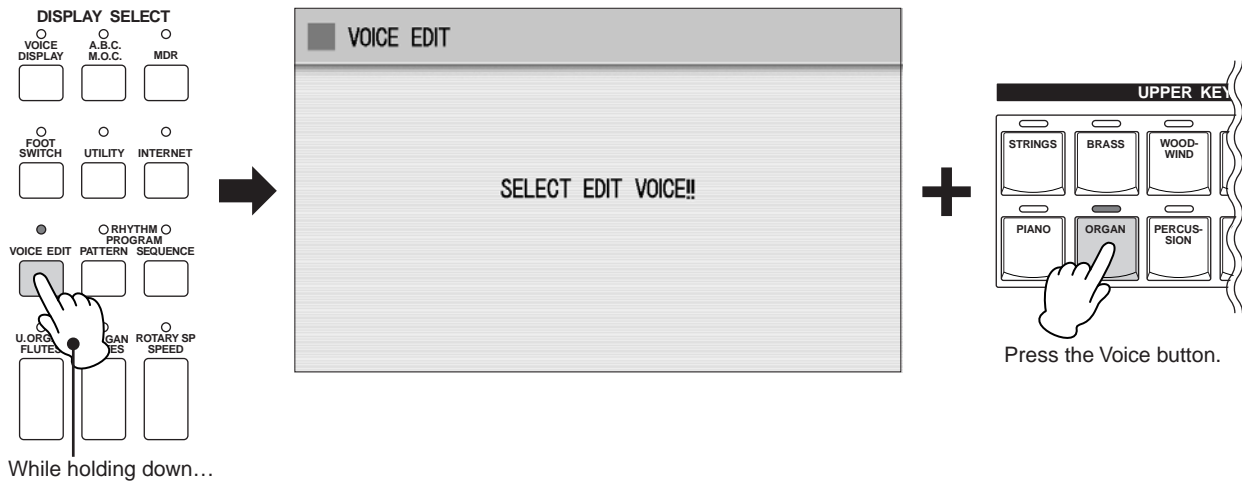

After you have selected the Voice button, the AWM Page (first page of the Voice Edit display) will appear if the selected Voice is an AWM Voice. If you have selected a VA Voice, the VA Page will appear.

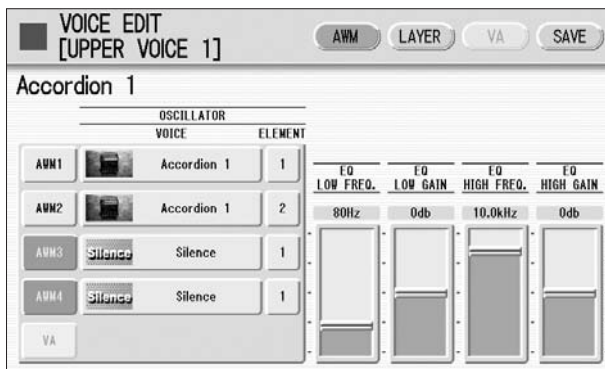

If you release the [VOICE EDIT] button before pressing a Voice button, the Voice Edit function will not be called up, and the normal Voice Display will appear.

The message “Voice data is too large to edit” may appear when you press the Voice button while holding down the [VOICE EDIT]. If this message appears, select another Voice.

Editing an AWM Voice

You can edit an AWM Voice on the AWM Page and LAYER Page in the Voice Edit display. In the AWM Page, the tonal balance of the entire Voice can be corrected by some EQ parameters. In the LAYER Page, you can make detailed edits to each Element.

AWM Page

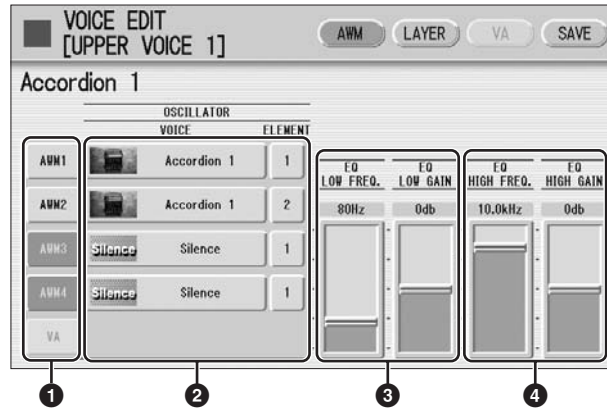

1 Element On/Off switches

The [AWM1] – [AWM4] buttons indicate the Elements which make up the selected Voice, and the [VA] button indicates the VA tone generator (the VA button is grayed out when you are editing an AWM Voice). You can mute any of the Elements by simply pressing the corresponding button. Pressing the button again cancels the mute.

2 VOICE/ELEMENT

Indicates the Voice/Element currently being edited. For example, the screen above shows that Element 1 of Accordion 1 is assigned to AWM1, the Element 2 of Accordion 1 is assigned to AWM2 and no Voice is assigned to AWM3 and AWM4. You can also call up another Element from another Voice and replace the currently selected Element with it. Pressing the VOICE or ELEMENT button in the display calls up the Voice or Element menu, from which you can select the desired Voice/Element (usually Element 1). If you change Voice, the Element will automatically change to the first Element of the Voice (usually Element 1).

3 EQ LOW FREQ./EQ LOW GAIN

Sets the frequency and gain (level) of the low frequency band. The EQ LOW FREQ. slider sets the desired frequency band over a range of 32 Hz – 2.0 kHz. The EQ LOW GAIN slider sets the level for the frequency band (specified by the EQ LOW FREQ. slider) over a range of -12 dB – +12 dB.

4 EQ HIGH FREQ./EQ HIGH GAIN

Sets the frequency and gain (level) of the high frequency band. The EQ HIGH FREQ. slider sets the desired frequency band over a range of 500 Hz – 16.0 kHz. The EQ HIGH GAIN slider sets the level for the frequency band (specified by the EQ HIGH FREQ. slider) over a range of -12 dB – +12 dB.

EQ (Equalizer)

Usually an equalizer is used to correct the sound output from amps or speakers to match the special character of the room. The sound is divided into several frequency bands, then by raising or lowering the level for each band, the correction is made. This Electone has a two-band (high and low) digital equalizer that lets you adjust the overall sound according to the type of music you play — classical music being more refined and soft, pop music more crisp, and rock music more dynamic.

LAYER Page

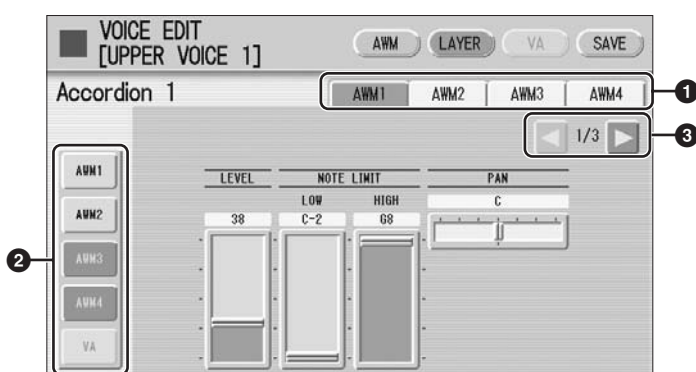

① Element select buttons

Select the Element you wish to edit.

② Element On/Off switches

The [AWM1] – [AWM4] buttons indicate the Elements which make up the selected Voice, and the [VA] button indicates the VA tone generator (the [VA] button is grayed out when you are editing an AWM Voice). You can mute any of the Elements by simply pressing the corresponding button. Pressing the button again cancels the mute. Muting all other Elements except for the one you are editing lets you clearly hear that single Element for ease in editing. Note that when some Elements are muted, playing the keyboard in certain key areas or with certain velocities may result in no sound.

③ Display switch buttons

The LAYER Page contains three pages. The ◀ ▶ buttons are used to switch among them.

LAYER Page 1

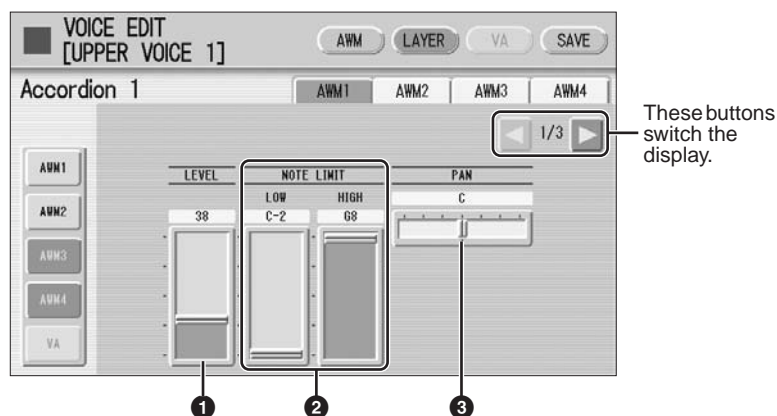

1 LEVEL

Determines the output level of the Element.

Range: 0 – 127

2 NOTE LIMIT

Determines the lowest and highest notes in the range for which the Element sounds. The setting of the HIGH slider cannot be set lower than that of the LOW slider. Some Elements are not affected by this parameter.

Range: C-2 – G8

3 PAN

Determines the position of the Element in the stereo image.

Range: L64 – R63

LAYER Page 2

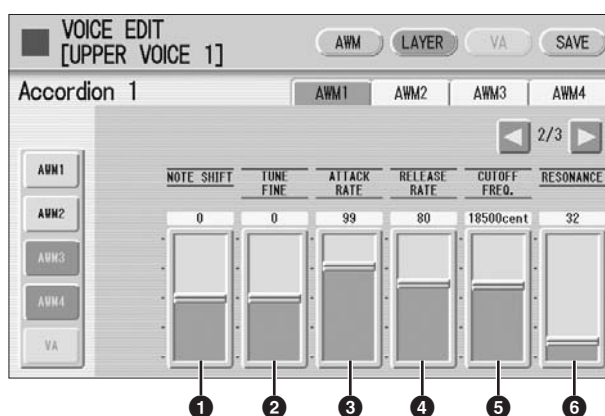

1 NOTE SHIFT

Determines the pitch settings in semitones.

Range: -64 – +63

2 TUNE FINE

Determines the fine tuning.

Range: -64 – +63

3 ATTACK RATE

Determines how quickly the Element will reach its maximum level after the key is played. Higher values produce a faster attack.

Range: 0 – 127

4 RELEASE RATE

Determines how much time it takes for the level to reach 0 after the key is released. Higher values make the time shorter.

Range: 1 – 127

5 CUTOFF FREQ.

Determines the cutoff frequency of the filter.

Range: 9600 – 24000 cent

6 RESONANCE

Determines the amount of resonance (harmonic emphasis) applied to the signal at the cutoff frequency. Some Elements are not affected by this parameter.

Range: 16 – 140



Reference Page

Envelope Parameters
(page 140)

Filter — Cutoff frequency and Resonance

Filter modifies the tone by cutting the output of a specific frequency portion of the sound. This Electone is equipped with a low pass filter, which passes only those signals below the cutoff frequency and cuts signals above the cutoff frequency.

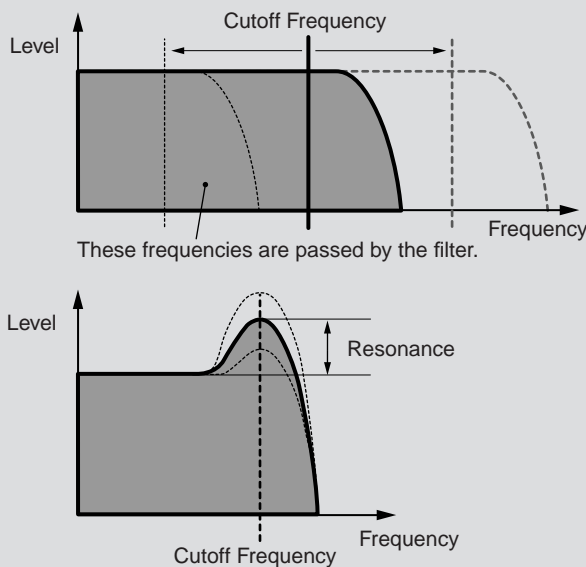

You can produce a relatively bright or darker sound by setting the cutoff frequency. Resonance is a parameter that boosts the level of the signal in the area of the cutoff frequency. By emphasizing the overtones in this area, this can produce a distinctive “peaky” tone.

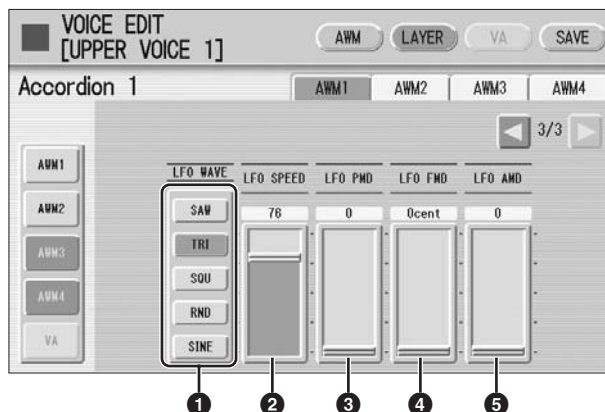

1 LFO WAVE

Determines the LFO waveform used to vary the sound. For details, see page 139.

2 LFO SPEED

Determines the speed of the LFO waveform. Higher values make the speed faster.

Range: 2 – 93

3 LFO PMD (Pitch Modulation Depth)

Determines the amount by which the LFO waveform varies the pitch of the sound. Higher values result in a greater amount of pitch change. For the minimum setting, the pitch does not change.

Range: 0 – 400

4 LFO FMD (Frequency Modulation Depth)

Determines the amount by which the LFO waveform varies the filter cutoff frequency. Higher values result in a greater amount of frequency change. For the minimum setting, the frequency does not change.

Range: 0 – 4800 cent

5 LFO AMD (Amplitude Modulation Depth)

Determines the amount by which the LFO waveform varies the amplitude of the sound. Higher values result in a greater amount of amplitude change. For the minimum setting, the amplitude does not change.

Range: 0 – 128



Reference Page

Vibrato (page 41)

When playing a User Voice you have created using the LFO parameters (above), set the Vibrato setting in the Voice Condition display to “Preset,” not “User.” If Vibrato is set to “User” and the Vibrato parameters (depth and/or speed) are set fairly high, you may not be able to hear the effect of the LFO.

LFO (Low Frequency Oscillator)

As its name suggests, the LFO creates waveforms of a low frequency. These waveforms can be used to vary the pitch, filter or amplitude to create effects such as vibrato, wah and tremolo.

The following five waveforms are available.

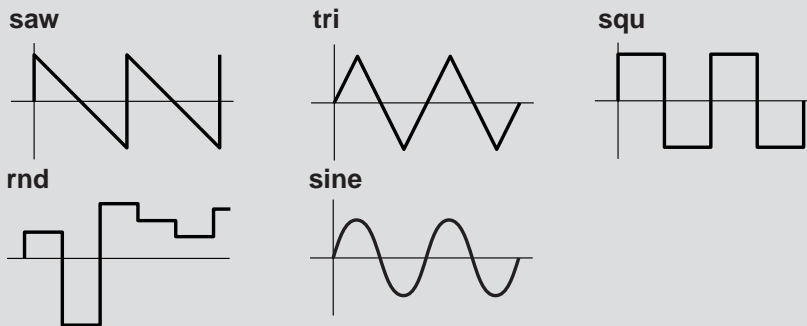

Editing a VA Voice (only for ELS-01C)

You can edit a VA Voice in the VA Page of the Voice Edit display. If you are using the ELS-01, the VA Page cannot be selected.

VA Page

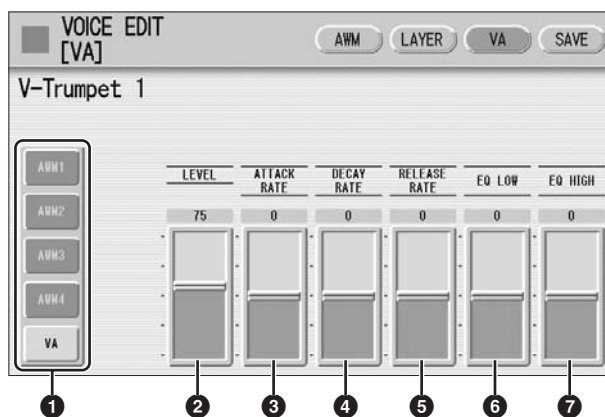

1 Element On/Off switches

The [AWM1] – [AWM4] buttons indicate the Elements which make up the selected Voice, and the [VA] button indicates the VA tone generator. You can mute any of the Elements by simply pressing the corresponding button. Pressing the button again cancels the mute. AWM buttons are grayed out when you are editing a VA Voice since VA Voices do not contain Elements. However, you can add AWM Elements to a VA sound in the AWM and LAYER Pages if you want. See page 134.

2 LEVEL

Determines the level of the VA sound.

Range: 0 – 127

③ ATTACK RATE

Determines how quickly the sound will reach its maximum level after the key is played. Lower values produce a slower attack.

Range: -64 – +63

④ DECAY RATE

Determines how much time it takes to reach its second level from the first (maximum) level.

Range: -64 – +63

⑤ RELEASE RATE

Determines how much time it takes for the level to reach 0 after the key is released. Positive value makes the time shorter and negative value makes it longer.

Range: -64 – +63

⑥ EQ LOW

Determines the level (volume) of the low range frequencies. Positive values boost or increase the level, while negative values decrease or cut it.

Range: -64 – +63

⑦ EQ HIGH

Determines the level (volume) of the high range frequencies. Positive values boost or increase the level, while negative values decrease or cut it.

Range: -64 – +63



Reference Page

EQ (Equalizer); (page 135)

Envelope Parameters

The level envelope lets you control the transition in volume from the moment a note is pressed on the keyboard to the moment the sound stops. The parameters

② – ⑤ above are envelope-related parameters.

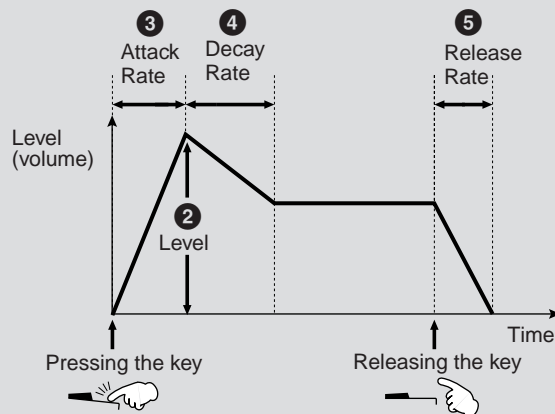

3 Saving the edited Voice

Edited AWM Voices can be saved as User Voices (up to sixteen), and edited VA Voices can be saved as VA Custom Voices (up to six).

- 1 Press the [SAVE] button at the top right of the display to call up the SAVE Page.

When saving User Voices (AWM)



When saving VA Custom Voices (VA)

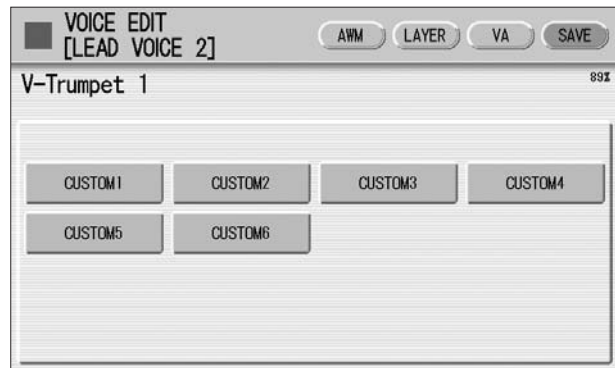

- 2 Select the User Voice number or VA Custom Voice number you wish to save to.

The message appears to prompt confirmation of the operation. (Saving a new Voice automatically erases the Voice previously stored to the selected User number.)

- 3 (If necessary) Press the [RENAME] button to give a name to your original Voice.

The method for editing the name is the same as the one for the song name in the M.D.R. section. (See page 108 for more information.) Up to sixteen characters can be entered.

- 4 Press the [SAVE] button to save the Voice, or press [CANCEL] to abort the operation.



This operation automatically erases any Voice that had been previously saved to the selected User Voice number or VA Custom Voice number. Be careful not to erase any important data. Always save your important data in advance to a USB flash memory or other external media using the M.D.R. function.

After saving the Voice, be sure to quit the Voice Edit function (page 142) before turning the power off. Turning off the Electone without quitting Voice Edit erases the User Voice you have edited.

4 Quitting Voice Edit

You can quit the Voice Edit function from any of its display pages.

1 Press the [VOICE EDIT] button on the panel.

If your original Voice has already been saved, the Voice Edit function quits automatically. If the edited Voice has not been saved, a message appears prompting confirmation of the operation.

2 Select [EXIT] to quit the Voice Edit function, or [CANCEL] to abort the operation and return to the previous display.



When quitting Voice Edit, the square at the top left of the display turns light blue for a few seconds, indicating that the Voice you have created is currently being saved. Do not turn the power off while the Voice is being saved.

5 Recalling an Edited Voice

Once your original AWM Voice has been saved, it can be selected from the User button in each Voice section. Refer to chapter 2, “Selecting Voices from the User buttons” (page 28).

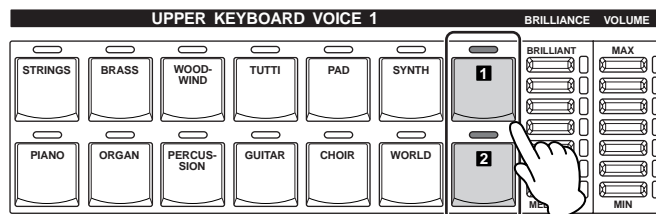

Once your original VA Voice has been saved, it can be selected from the [VA CUSTOM] button in LEAD VOICE 2. Refer to chapter 2, “Selecting Voices with the Voice buttons” (page 23).

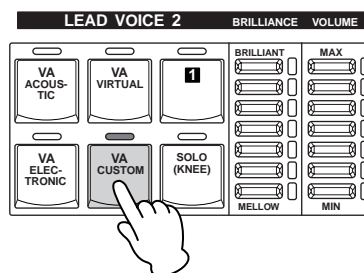

Rhythm Program

The Electone includes powerful rhythm programming functions: Rhythm Pattern Program and Rhythm Sequence Program. Rhythm Pattern Program allows you to record your own original rhythms and save them as user rhythms. Rhythm Sequence Program lets you connect the existing rhythms or your original rhythms to create complete rhythm tracks, which you can automatically play back during your performance. Moreover, Rhythm Sequence Program includes an automatic Registration Shift feature — called Registration Sequence.

Contents

1 Outline of the Rhythm Programming Operation	143	
2 Rhythm Pattern Program	144	
• Entering the Rhythm Pattern Program	144	
• Basic settings for the Rhythm Pattern	146	
• Entering Percussion Sounds to a Rhythm Pattern – Step Write	150	
• Editing Entered Percussion Notes	152	
• Entering Percussion Sounds to a Rhythm Pattern – Real Time Write	157	
• Creating Backing Patterns (Rhythmic Chord Function)	158	
• Changing the Voices for Accompaniment Parts	161	
• Adjusting Volume and Panning	162	
• Effect Settings	163	
• Detailed settings for each percussion instrument	166	
• Saving Rhythm Patterns	167	
• Quitting the Rhythm Pattern Program	169	
• Recalling User Rhythm Patterns	169	
		• Selecting Rhythm from an External Media 170
		• Percussion Kit List 171
3 Rhythm Sequence Program	174	
• Selecting a Sequence	174	
• Programming a Sequence	175	
• Auditioning a Sequence	177	
• Editing an Existing Rhythm Sequence	177	
• Programming a Registration Sequence	179	
• Editing an Existing Registration Sequence	181	
• Quitting the Rhythm Sequence Program	181	
• Playing Rhythm Sequences	182	
• Playing All Sequences in Order	182	
• Copying a Sequence	183	
4 Saving Rhythm Pattern and Rhythm Sequence Data to external media	184	

1 Outline of the Rhythm Programming Operation

Rhythm Pattern Program (pages 144 – 169)

You can create your original rhythm patterns by entering percussion sounds or editing preset rhythm patterns.

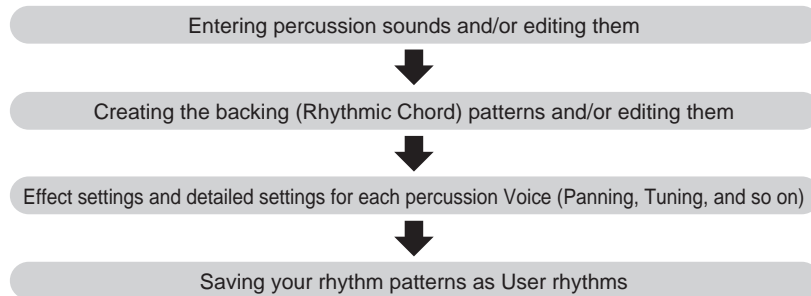

Rhythm Sequence Program (pages 174 – 181)

You can connect any of the rhythms together to make complete rhythm compositions. Moreover, you can also program Registration Shift events at any point in the composition so that the Registration Memory settings automatically change as the rhythm sequence plays back.

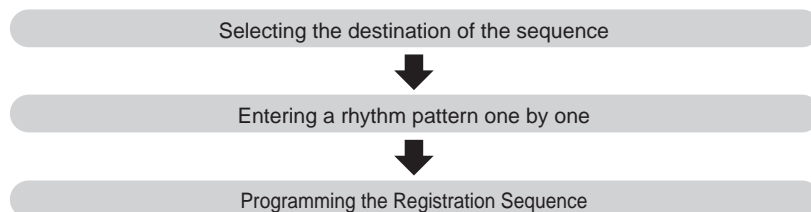

2 Rhythm Pattern Program

Rhythm Pattern Program lets you use any of the different instrument sounds (drum and percussion) assigned to each key on the Upper and Lower keyboards in creating your own rhythms. Up to 48 of your original rhythms can be saved as User Rhythms.

Entering the Rhythm Pattern Program

There are two ways to program a User pattern: copying a preset rhythm that is similar to the rhythm you want to create, and creating your own rhythm from scratch.

To copy a preset rhythm:

Copying a preset rhythm lets you make changes to an existing rhythm, saving you time if you want to program a rhythm that is similar to an existing preset pattern.

1 Select the rhythm you want to copy from the Rhythm Menu.

2 While holding down the [PATTERN] button in the panel (the display prompts you to select a rhythm), select the Rhythm button that contains the preset rhythm to be copied to the Rhythm Pattern Program.



NOTE

Pressing the [PATTERN] button while the rhythm is running automatically stops the rhythm.

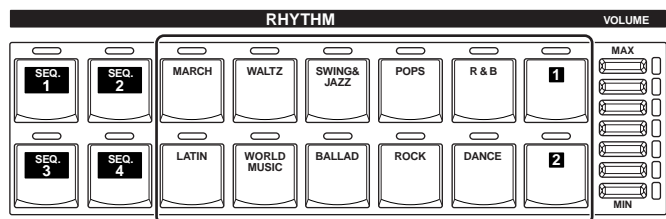
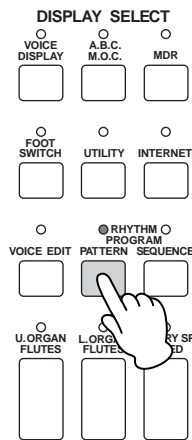

To create your own rhythm from scratch:

Press the [PATTERN] button and release it without selecting a Rhythm button.

A blank pattern is loaded to the Rhythm Pattern Program.

A Rhythm consists of 15 sections: Intro 1 – 3, Main A – D, Fill In A – D, Ending 1 – 3, and Break.

In Rhythm Pattern Program, you can enter or edit percussion notes one by one, or assemble each part from other different rhythms to create your own new User Rhythm.

Case 1: Creating your own rhythm by changing a preset rhythm

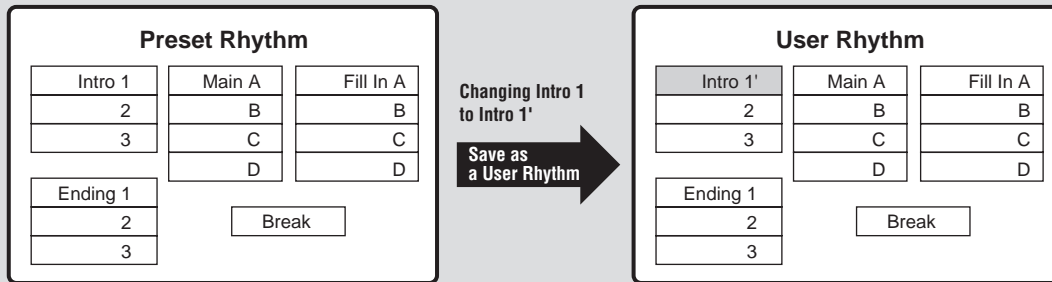

All Rhythm sections, including any which have not been edited, are saved as one User Rhythm.

Case 2: Creating your own rhythm by assembling parts from other different rhythms

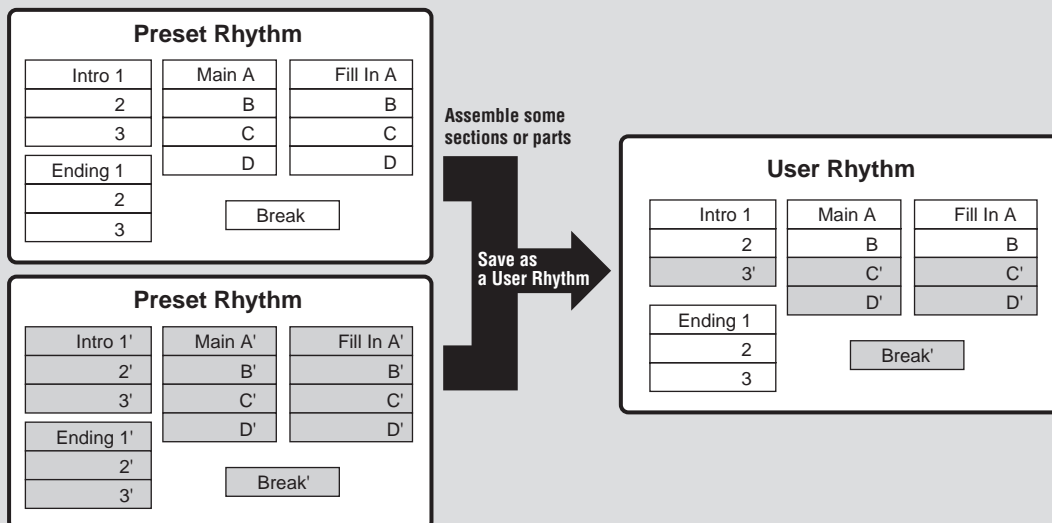

Case 3: Creating your own rhythm from scratch

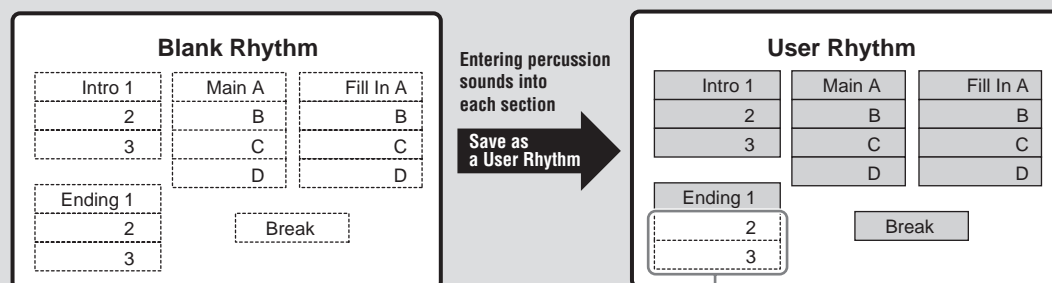

These are blank sections (no percussion sounds); if you press ENDING [2] or [3] button, no sound is played.

Basic settings for the Rhythm Pattern

In the SETTING Page of the display, set the conditions of the rhythm, such as time signature, measure length, and so on. You can also customize the part settings in this SETTING Page — deleting any part or copying a part from another rhythm to the currently selected rhythm.

- 1 Press the [SETTING] button in the display to call up the SETTING Page.

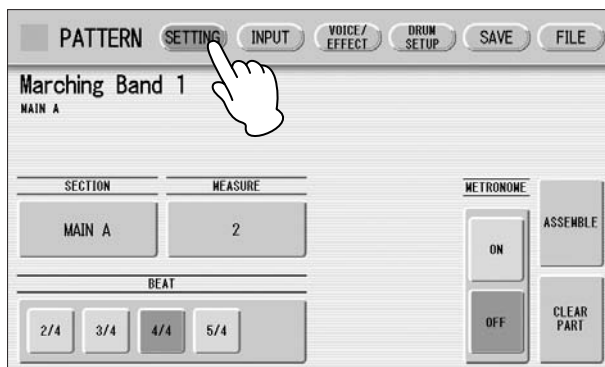

- 2 Determines the time signature used for the rhythm. You can select the time signature with the BEAT buttons.

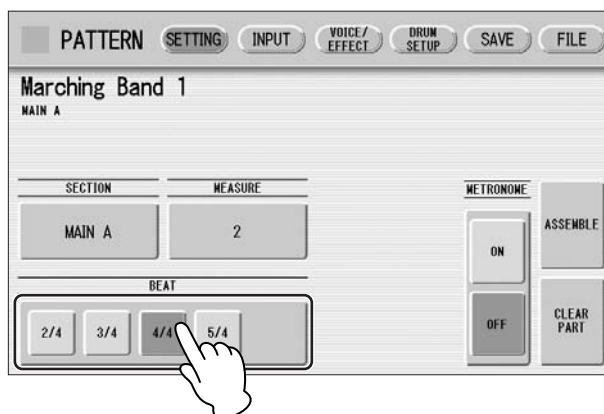

If you start the Rhythm Pattern Program from a preset rhythm, pressing a BEAT button that is not the same as the currently selected rhythm calls up the following message.



Selecting [CLEAR] deletes all data in the rhythm and changes the time signature.
Select [CANCEL] to abort the operation.

3 Select a section to which you want to enter or edit the rhythm pattern.

Pressing the SECTION button on the display calls up the Section Select pop-up menu. After selecting the desired section, the pop-up menu automatically closes.

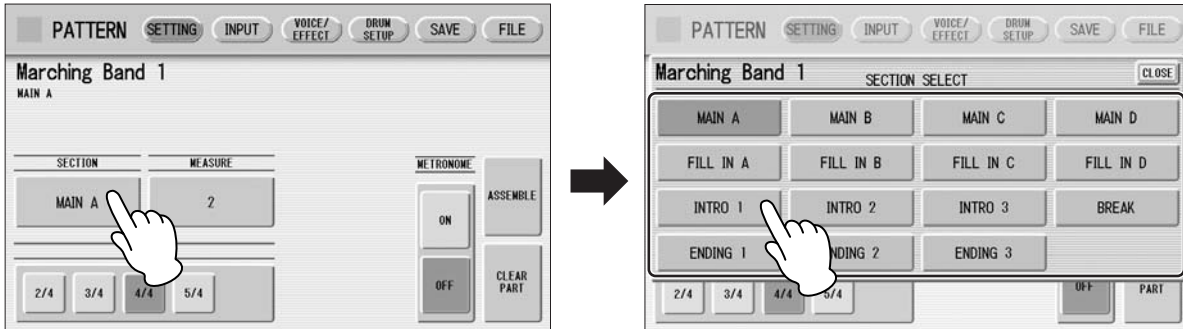

You can play the selected section by pressing the Rhythm [START] button on the panel. You can also change the section while the rhythm is playing. For details on muting the accompaniment part, refer to page 162.

4 Sets the measure length of the rhythm pattern.

Pressing the MEASURE button on the display calls up the Measure Select pop-up menu. Select the desired measure in the pop-up menu. If you select Break or Fill In as the section, the measure cannot be changed.

5 (If necessary) Set the Metronome, Part Assemble, and Part Clear parameters.

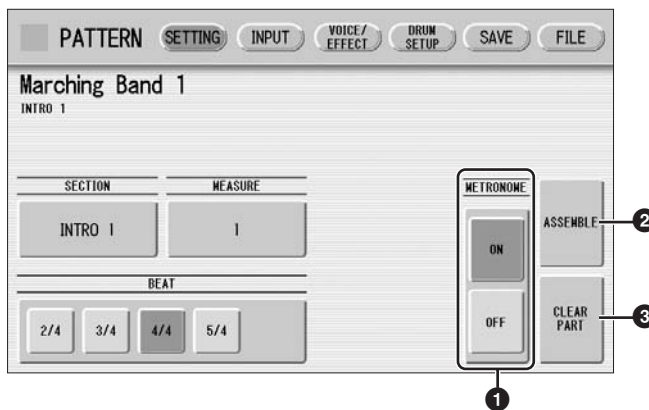

1 METRONOME

Turns the metronome click on or off. When set to ON, the metronome sounds on each beat of the measure (for example, three times per measure in 3/4 time) to serve as a rhythmic guide when programming patterns. Set to On here with Real Time Write.



Reference Pages

Step Write and Real Time Write (page 149)

Entering Percussion Sounds to a Rhythm Pattern — Real Time Write (page 157)



NOTE

Pressing the VOLUME buttons for Rhythm also changes the volume of the metronome.

2 ASSEMBLE

Copies the part from another rhythm to the currently selected rhythm. You can assemble various sections from multiple rhythms to create your original rhythm. Pressing the [ASSEMBLE] button calls up the following display.

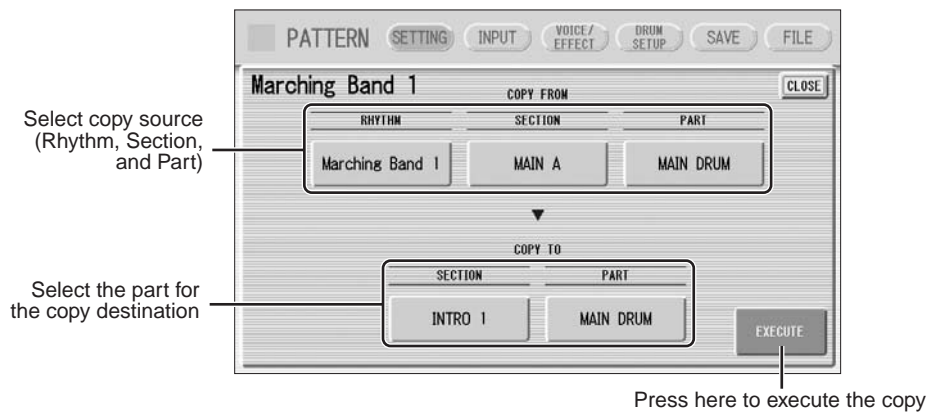

Select the copy source: Rhythm, Section and Part. Then select the destination. You can copy only one part, or all parts of a rhythm.

After setting the source and destination, press [EXECUTE]. Copy is executed and returning to the previous display.

You can also select a rhythm pattern currently being created as the COPY FROM RHYTHM.

To create a MAIN B section based on MAIN A, you can conveniently create that you create the MAIN A rhythm first and copy it to MAIN B, then edit the MAIN B rhythm.

To select the rhythm currently being created, select “Current Rhythm” on the 5th page of the “USER” category.

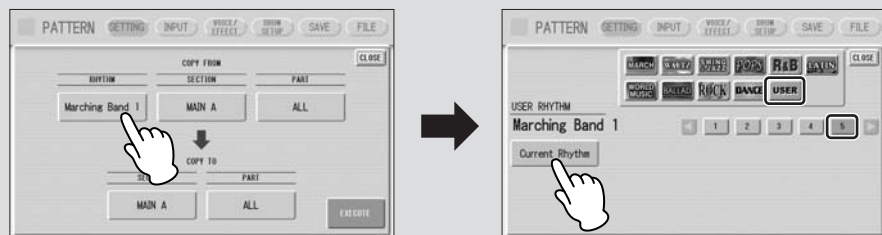

3 CLEAR PART

Clears a specific part or parts from the currently selected rhythm. Pressing this button calls up the following display.

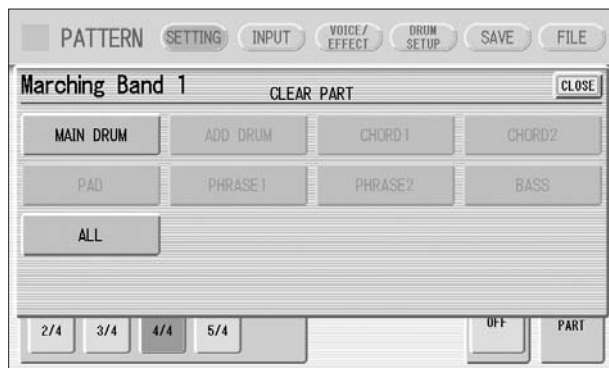

Select the part you want to delete from the displayed parts. You cannot select a part that contains no data (the button is grayed out). If you select [ALL] here, the percussion and all accompaniment parts are cleared.

When selecting the desired part, a display prompting confirmation of the operation appears. Select [CLEAR] to execute the operation, or select [CANCEL] to abort the operation.



Reference Page

Accompaniment (page 61)



NOTE

If you select BASS here, the bass phrase in the A.B.C. will be cleared.

Step Write and Real Time Write

There are two different methods you can use to program rhythms: Step Write and Real Time Write.

Step Write allows you to enter percussion sounds as individual note values. As a method, it is very similar to writing down the notes on a sheet of music paper; each note is entered one at a time, and though you can hear each individual note entered, you cannot actually hear the pattern playing as you create it. Step Write is good for precision and for entering percussion sounds whose note placement and rhythmic value has been determined, such as a bass drum that plays every beat in a measure.

Real Time Write on the other hand, is similar to using a multi-track tape recorder; you can hear previously recorded parts of the pattern as you record new parts on top. Real Time Write is best for capturing the “feel” of a rhythm, because it allows you to actually play the pattern as you are creating it.

Each method has its own advantages and uses. Which method you use depends partly on the type of rhythm you intend to create and partly on your own personal preference. You can switch between the two methods in editing to create a single rhythm by the use of both methods. This would come handy, for example, in programming the basic beats of a rhythm with Step Write, then using Real Time Write to add percussion accents and embellishments.

Which mode of the operation is selected depends on the play status of the rhythm. If the rhythm is stopped, Step Write is automatically selected. If the rhythm is playing, Real Time Write is selected. See the instructions below for Step Write, and page 157 for Real Time Write.

Entering Percussion Sounds to a Rhythm Pattern – Step Write



NOTE

The volume of the percussion and accompaniment sound during use of Rhythm Pattern Program can be controlled with the VOLUME button of the RHYTHM section. When you quit Rhythm Pattern Program, the VOLUME of the RHYTHM section will return to the previous selected level.

You can enter percussion sounds in the INPUT Page of the display. Before entering percussion sounds, turn off the Upper and Lower keyboard Voices by setting each Voice's volume to MIN.

- 1 Press the [INPUT] button at the top of the display to call up the INPUT Page.
- 2 Select the part, MAIN DRUM or ADD DRUM, to which you want to enter the percussion.

In general, main (or basic) drum/percussion instruments (such as Bass Drum, Snare Drum, and so on) are entered in Main Drum part and others (such as Tambourine, Triangle) are entered in Add Drum part.



- 3 Select the desired Drum Kit. You can select a kit from 20 Drum kits and 5 SFX kits. For details on each kit, see page 171. Pressing the button indicating the currently selected kit calls up the kit Select the pop-up menu, then select the desired kit from the pop-up menu. The selected kit is called up on the Upper and Lower keyboards.

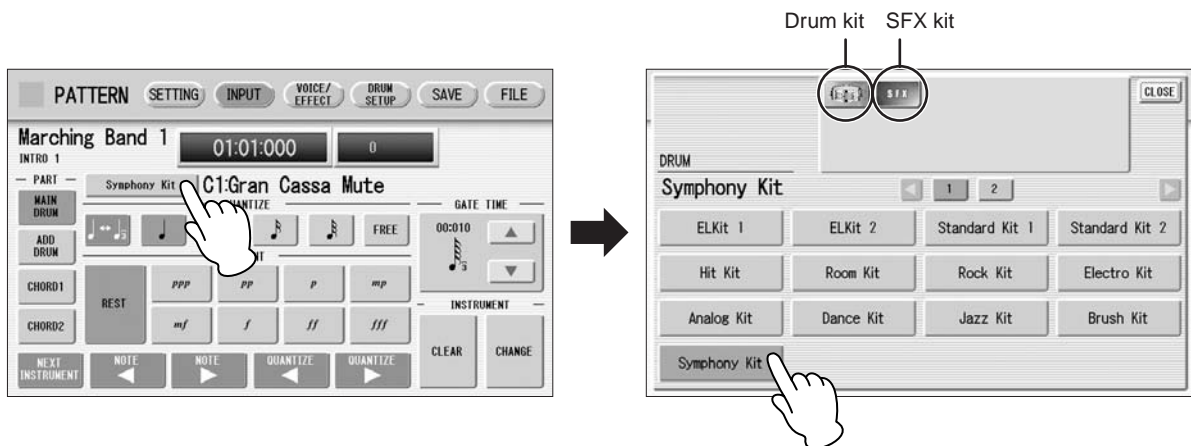

You can select only one kit for each part (Main Drum or Add Drum). When you want to create a rhythm pattern including two different drum kits, select one kit for Main Drum and another for Add Drum.

4 Select the percussion sound you wish to enter by pressing the key on the Upper or Lower keyboard that corresponds to the sound.

The selected instrument's name appears on the display.



5 Set the appropriate Quantize value.

For details on Quantize, refer to page 156.



NOTE

The Quantize setting can be changed in the middle of Step Write.



6 Set the Gate Time. (This is optional, and only necessary when you want to enter a sustaining sound, such as a whistle.)

For a list of instruments that require a Gate Time setting, refer to the Percussion Kit List on page 171. For details on Gate Time, refer to page 160.

7 Use the ACCENT buttons to enter the sound to the selected point. Press each ACCENT button to actually enter the percussion sounds.

You can change the rhythm clock to which the percussion sound is entered by pressing the QUANTIZE [◀] [▶] buttons.

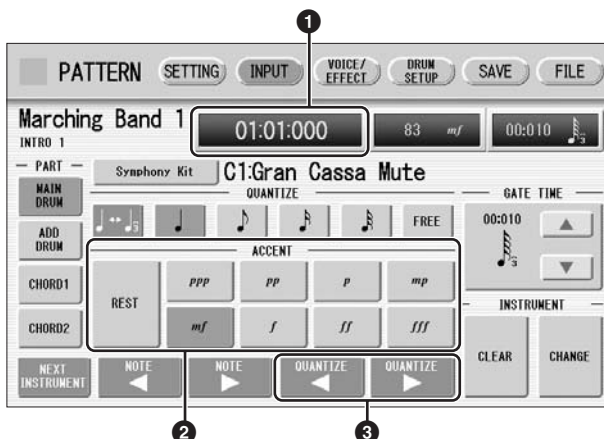

1 Rhythm Clock box

Displays the current position in the pattern according to measure, beat, and number of clicks.

A click is the smallest division of a pattern, and one beat is made up of 480 clicks.

The rhythm clock advances up to the measures set in the SETTING Page and loops back to the beginning of the rhythm (01:01:00).



Reference Page

Basic settings for the Rhythm Pattern (page 146)

2 ACCENT buttons

Records the instrument and determines its volume or Accent level. Press one of the ACCENT buttons you wish to set (“*ppp*” is softer and “*fff*” is louder; “REST” is no sound). The instrument is automatically inserted at the Accent level to the selected position in the pattern. Selection of an Accent level automatically advances the rhythm clock by one step, according to the current Quantize resolution value.

3 QUANTIZE [◀] [▶] controls

Each press of the buttons advances or reverses the rhythm clock by one step. The size of a single step is determined by the Quantize value.

8 Repeat steps 4 through 7 above to layer each instrument and complete your own rhythm.

Editing Entered Percussion Notes

You can change the accent level, position, or gate time of the entered sound, or delete the entered sound.

To change the accent level of an entered note:

1 Select the desired note for changing the accent level.

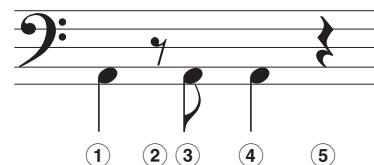
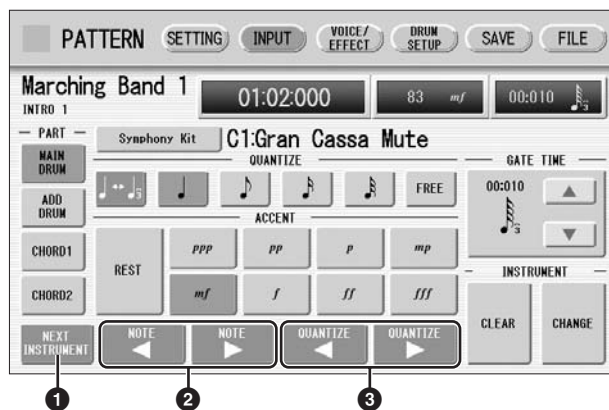

1 NEXT INSTRUMENT

Selects the entered instruments one by one, from left key to right.

2 NOTE [◀] [▶] controls

Selects the previous/next position's note of the currently selected instrument. In the above notes for example, you can select notes ①, ③ and ④ one by one. Rests ② and ⑤ are ignored.

3 QUANTIZE [◀] [▶] controls

Advances or reverses the rhythm clock by one step. The size of a single step is determined by the Quantize value.

2 Change the accent level by using the ACCENT buttons or Accent box.

The Accent box allows for finer changes.

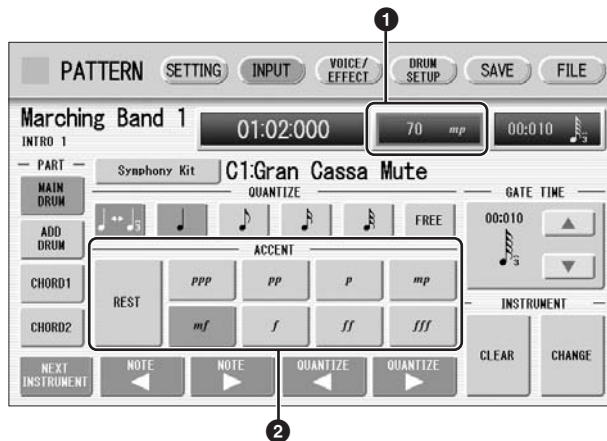

1 Accent box

Touch on the box to enable the Accent box.

Turning the Data Control dial changes the accent level over a range of 0 – 127.

The minimum setting results in no sound.

2 ACCENT buttons

Determines the coarse accent level. Eight accent levels (from “*ppp*” to “*fff*”) are available.

Press the desired Accent button to change the currently selected note to the selected level.

To move an entered note:

- 1 Select the note you want to move (as in Step 1 on page 152).
- 2 Press the Rhythm Clock box to enable the box.



- 3 Turn the Data Control dial to change the position by one clock.

To change the length of an entered note:

The length of sustaining sounds such as Snare Roll and Whistle can be changed by adjusting the Gate Time. See page 161 for more information.

To erase an entered note:

- 1 Select the note you want to erase (as in Step 1 on page 152).
- 2 Press the [REST] button in the ACCENT section of the display. The selected note is deleted and replaced with a rest.



You can also erase all notes of a single instrument, or all notes entered.

To erase one instrument:

- 1 Select the key to which the instrument that you want to erase is assigned.

The key name you have selected and its instrument name are displayed.

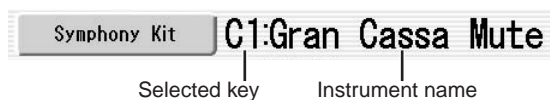

- 2 Press [CLEAR] in the display. The following display appears, prompting confirmation of the operation.

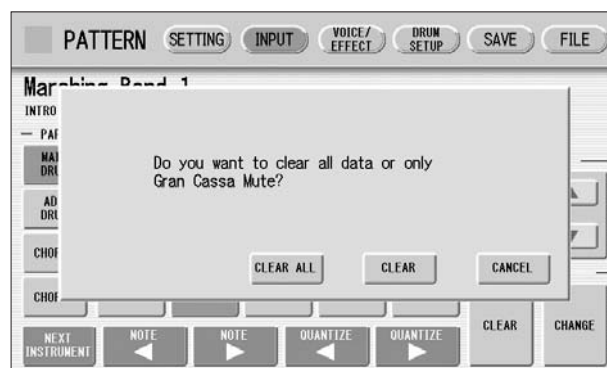

- 3 Select [CLEAR] to erase the selected instrument. A bell sound indicates that the instrument has been erased.

The following method can also be used to erase one instrument.

While holding down the [CLEAR] button, press the key on the keyboard corresponding to the instrument you wish to erase.

A bell sound indicates that the instrument has been erased.

To erase all instruments:

- 1 Press [CLEAR] in the display.**
The following display appears, prompting confirmation of the operation.



- 2 Select [CLEAR ALL] to erase all instruments.**
All instruments are instantly erased.

When you want to replace the instrument you have already entered with another instrument, it's not necessary to delete and re-enter. You can quickly replace the sound with the following procedure.

To replace the instrument:

Before the operation, stop the rhythm.

- 1 Select the key to which the instrument you want to replace is assigned.**

The key name you have selected and its instrument name are displayed.

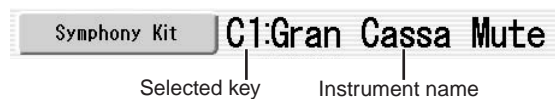

- 2 Simultaneously hold down the [CHANGE] button in the display and press the key on the Upper or Lower keyboard that corresponds to the instrument you want to use.**

The instrument is instantly erased and replaced with the newly selected one.

About Quantize

The Quantize function is a process of rounding off timing or duration values, so that each note plays with precise timing. You can select nine types of Quantize value.

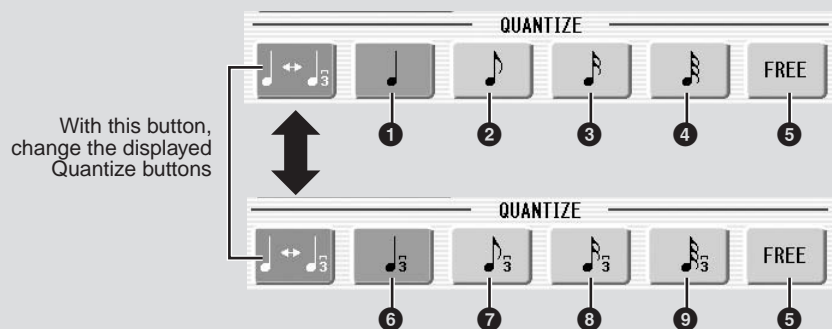

With Step Write

It allows you to automatically correct the length (duration) and timing of each note you enter.

Steps Depending on the Quantize Values

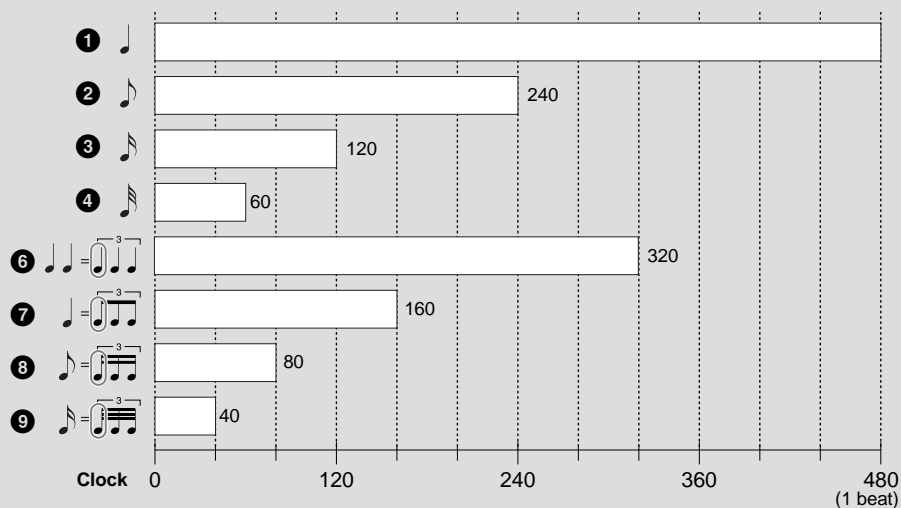

Setting Quantize to FREE (5) results in the finest, least amount of quantization (1/480 beat).

With Real Time Write

It allows you to automatically correct the timing of the notes you play, according to the specified Quantize resolution. No correction occurs when you select FREE. Generally, you should set Quantize to be the same as the shortest note you intend to play.

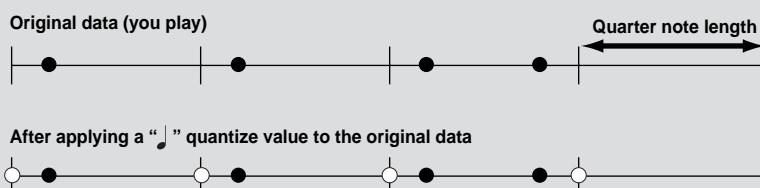

Entering Percussion Sounds to a Rhythm Pattern — Real Time Write

While you listen to the entered rhythm or metronome click, play the Upper/Lower keyboards to enter the desired percussion sounds.

- 1 **Select the desired part to which the percussion sounds are entered, and the desired drum kit, by following Steps 1 – 3 on page 150.**
- 2 **Set the appropriate Quantize value.**
The positions at which the sounds are input will be corrected according to the predetermined Quantize value in the Real Time Write operation. For details, refer to page 156.



- 3 **Press the rhythm [START] button in the panel.**
The rhythm (or Metronome) starts playing, enabling the Real Time Write operation.



- 4 **While the rhythm is running, play the percussion sounds from the Upper and/or Lower keyboards.**

If you have started the Rhythm Pattern Program by copying a preset rhythm, you can listen the selected rhythm as you play the sound. If you have started from scratch, set the Metronome to “on” in the SETTING Page and listen to the metronome click. The pattern will automatically repeat (or “loop”) for a certain number of measures as set in the SETTING Page.

 **Reference Page**
Metronome (page 147)

- 5 **Repeat steps 2 through 4 above to layer each instrument and complete your own rhythm.**

You can erase an instrument while rhythm is played.

To erase an instrument/key assignment:

While holding down the [CLEAR] button, press the key on the keyboard corresponding to the instrument you wish to erase. All instances of the selected instrument will be erased from the pattern.

When you want to erase all instruments, or edit entered percussion notes, you need to stop the rhythm then edit. See page 152, “Editing Entered Percussion Notes.”

Creating Backing Patterns (Rhythmic Chord Function)

The Rhythm Pattern Program allows you to use one of the Electone’s Accompaniment patterns with your original rhythm. You can select and save the Accompaniment pattern that best matches the rhythm that you have created. Moreover, Rhythm Pattern Program features a Rhythmic Chord function that lets you add your own backing patterns to the rhythms you create.

To select an appropriate Accompaniment pattern for your newly created rhythm:

- 1 Press the [SETTING] button at the top of the display to call up the SETTING Page.
- 2 Press the [ASSEMBLE] button.
A pop-up menu appears, letting you select the copy source and destination part.
- 3 Using the COPY FROM [RHYTHM] and [SECTION] buttons, select the rhythm and the section which has the accompaniment you wish to use.



Reference Page

Basic settings for the Rhythm Pattern (page 146)



- 4 Using the COPY FROM [PART] button, select the accompaniment part you want to copy.
- 5 Using the COPY TO [PART] button, select the desired accompaniment part (CHORD 1 or CHORD 2) to be used for the Rhythmic Chord pattern.

6 Press the [EXECUTE] button to execute the copy.

The desired accompaniment part (Rhythmic Chord pattern) has been copied.

To create your own backing patterns with the Rhythmic Chord function:

The Rhythmic Chord pattern can be entered by the same methods as the rhythm: Step Write and/or Real Time Write.

- 1 Press the [INPUT] button at the top of the display to call up the INPUT Page.
- 2 Select the part, CHORD 1 or CHORD 2, which you want to create for the Rhythmic Chord pattern.

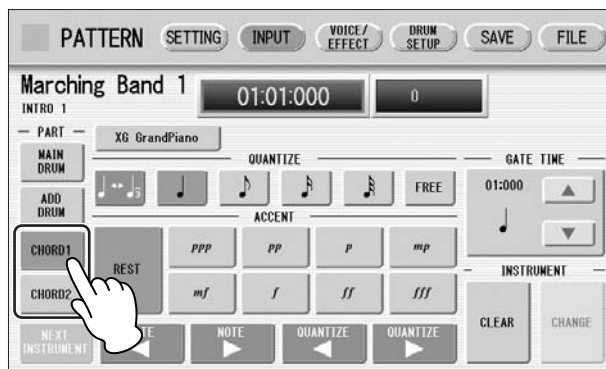

If the part you have select contains a preset accompaniment pattern, a message appears prompting you to confirm whether you want to clear the existing data or not. To create your own Rhythmic Chord pattern, select [CLEAR].

- 3 Select the desired Voice.
- Pressing the button showing the Voice name calls up the relevant Voice Menu. Select the desired Voice category with the instrument icon buttons, then select the desired Voice from the Voice Menu. The selected Voice is called up for both the Upper and Lower keyboards.



NOTE

The Voice menu that appears here is not the same as the one for the Voice Sections.

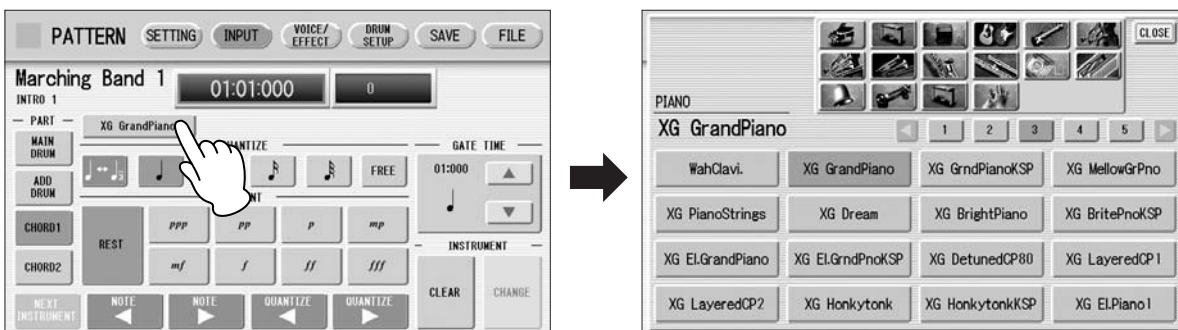



Voices can also be changed even after entering the Rhythmic Chord pattern. You can select only one Voice for one part (Chord 1 or Chord 2). When you want to create a Rhythmic Chord pattern including two different Voices, select one Voice for Chord 1 and another for Chord 2.

4 Set the appropriate Quantize value.

For details on the Quantize function, refer to page 156.

5 Set the Gate Time.

You can adjust the Gate Time setting by using the GATE TIME   buttons in the display, or the Data Control dial. Using the buttons in the display makes coarse changes in the value. Using the Data Control dial makes fine changes.

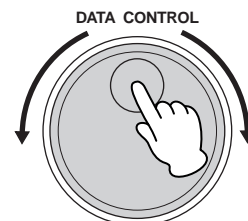

Gate time determines the actual length of time a note sounds. For example, a quarter note is sometimes played as tenuto (long length) and sometimes played as staccato (short length).

Since 1 beat is made up of 480 clocks, a quarter note played tenuto may have a gate time between 450 – 470, and a staccato quarter note may be about 240.

6 Enter the Rhythmic Chord pattern.

The methods for entering the Rhythmic Chord pattern are the same as those for entering the rhythm pattern. Any key you press sounds a C major triad chord (C, E, and G). For information on Step Write, see page 151; for information on Real Time Write, see page 157.

You can also edit the entered Rhythmic Chord pattern using the same method as in “Editing Entered Percussion Notes” (page 152). To change the gate time of the notes of the Rhythmic Chord pattern, follow the instructions below.

To change the Gate Time:

- 1 Select the note for which you want to change the gate time (see Step 1 on page 152).
- 2 Press the Gate Time box to enable the box.



- 3 Turn the Data Control dial to change the Gate Time.

Changing the Voices for Accompaniment Parts

In Rhythm Pattern Program, you can create your original drum patterns using Main Drum and Add Drum, and original backing patterns using Chord 1 and Chord 2. Moreover, you can change the Voices for all accompaniment parts, including Pad, Phrase 1 and Phrase 2. Voices can be changed in the VOICE/EFFECT Page.

- 1 Press the [VOICE/EFFECT] button at the top of the display to call up the VOICE/EFFECT Page.
- 2 Press the [VOICE] button in the display. The following display will appear.

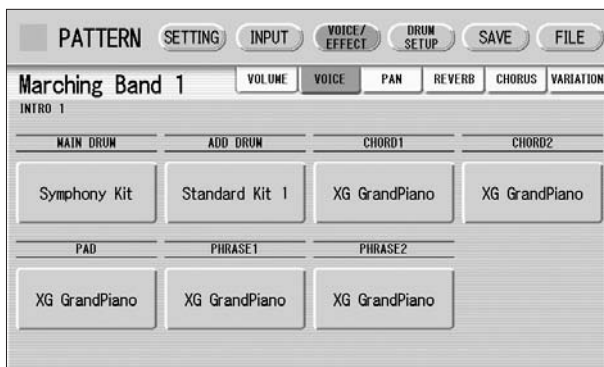

3 Select the desired part for which you wish to change the Voice. The Voice menu appears.

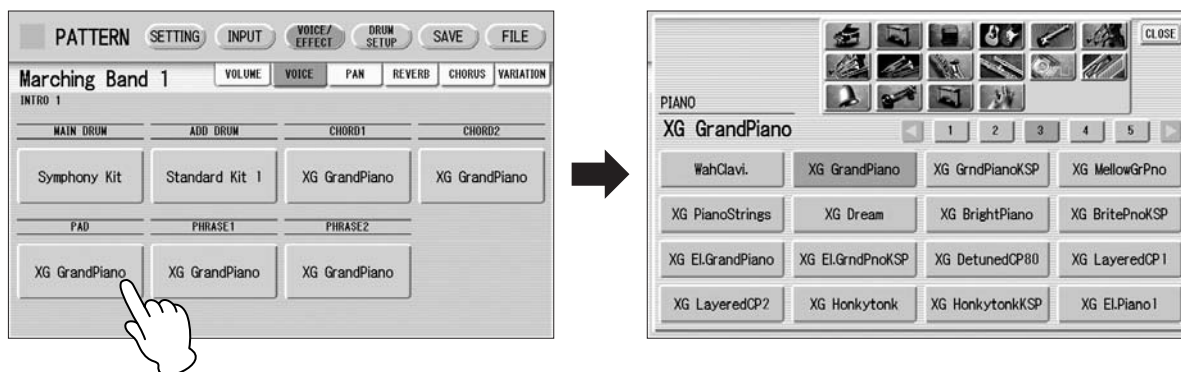

NOTE

The Voice menu that appears here is not the same as the one for the Voice Sections.

4 Select the desired Voice, and the Voice menu automatically closes.

After selecting the desired Voice, customize the accompaniment to your personal preference by adjusting the volume and pan, and setting the desired effects below.

Adjusting Volume and Panning

Volume and Pan are set in VOICE/EFFECT Page.

VOLUME Display

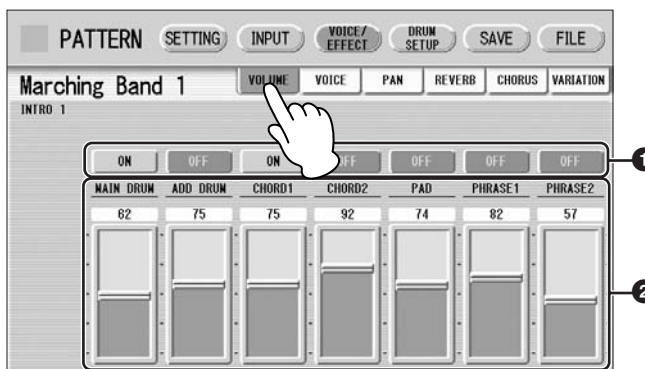

1 ON/OFF

Determines the on/off status of each accompaniment part. When this is set to OFF, the part is muted.

2 Volume sliders

Determines the volume of each accompaniment part.

Range: 0 – 127

PAN Display

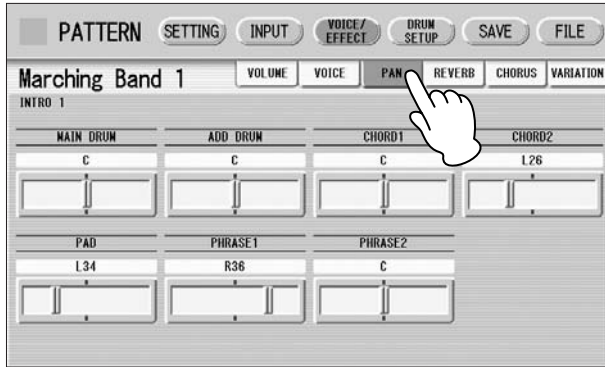

Determines the position of each accompaniment part in the stereo image.

Range: L64 – R63

Effect Settings

You can set Reverb, Chorus, and Variation effects as desired for your original rhythm. Reverb adds a warm ambience to the sound, simulating the complex reflections of actual performance spaces, such as a concert hall or a small club. Chorus provides a wide variety of sound transformations and enhancements. Variation includes many kinds of special effects for changing the sound, both subtly and radically. These effects are set in the VOICE/EFFECT Page.

REVERB Display

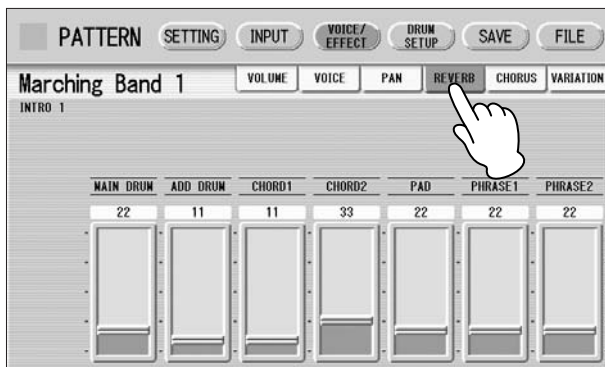

Determines the amount of reverb applied to each accompaniment part.

Range: 0 – 127

CHORUS Display

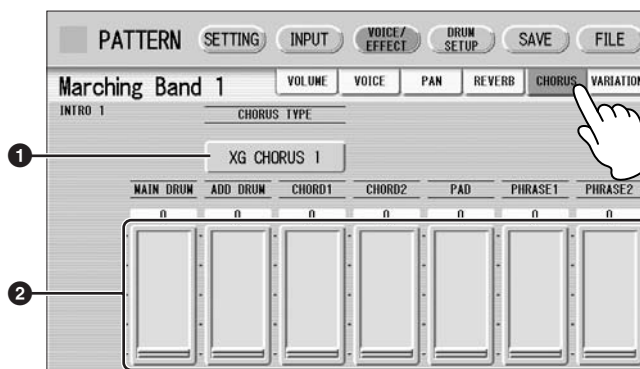

1 CHORUS TYPE

Determines the type of the chorus effect. Pressing the CHORUS TYPE button calls up the chorus type list.

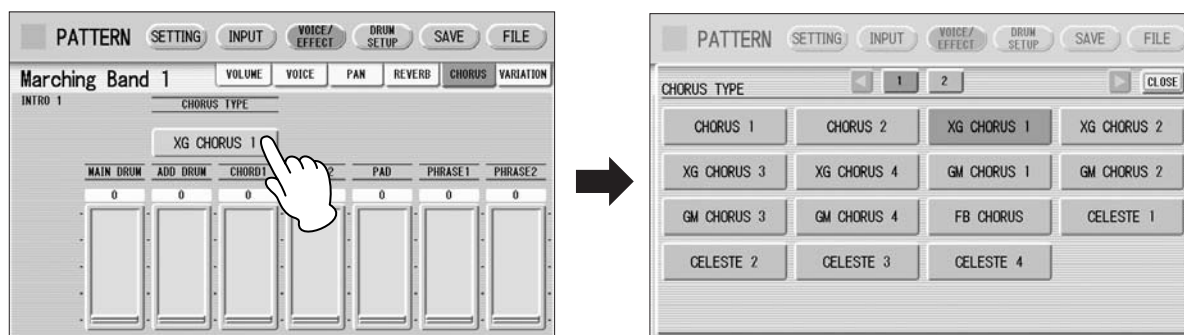

Select the desired chorus type, and the list automatically closes.

2 Chorus sliders

Determines the amount of chorus effect applied to each accompaniment part.

Range: 0 – 127

VARIATION Display

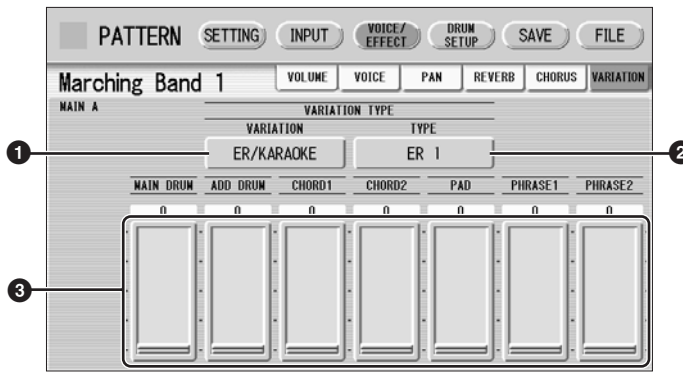

1 VARIATION (Variation Effect Category)

Selects the effect category of the variation effect. Pressing the VARIATION button calls up the effect category list.

 **Reference Page**
Effect List (page 50)

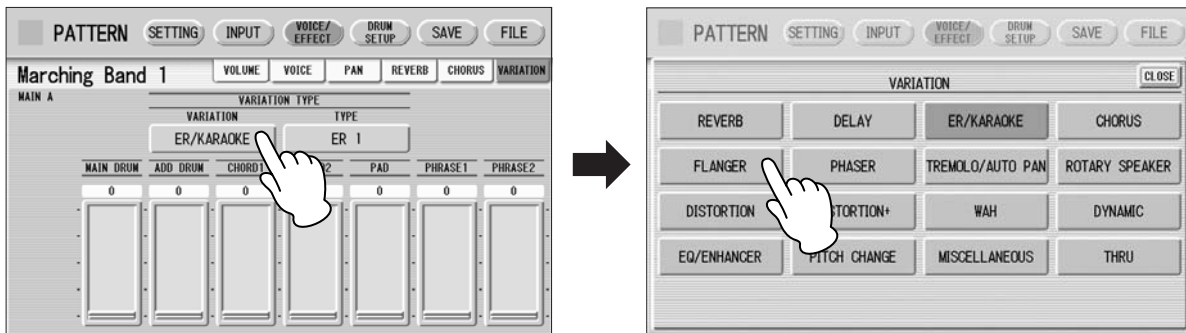

Select the desired effect category, and the list automatically closes. After changing the category, the variation type below automatically changes corresponding to the selected category.

2 TYPE (Variation Type)

Determines the type of the variation effect. Pressing the TYPE button calls up the effect type list.

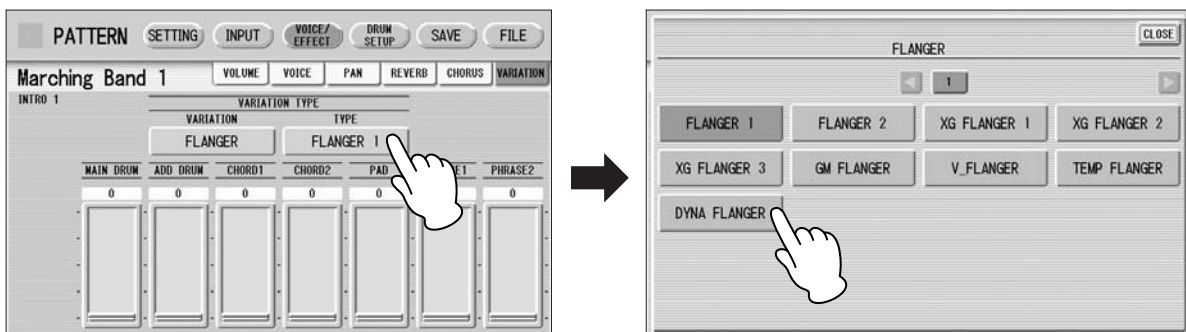

Select the desired type, and the list automatically closes.

3 Variation sliders

Determines the amount of Variation effect applied to each accompaniment part.

Range: 0 – 127

Detailed settings for each percussion instrument

You can independently adjust the settings of pan, pitch, reverb and volume for each instrument.

- 1 Press the [DRUM SETUP] button at the top of the display to call up the DRUM SETUP Page.
- 2 Select the desired part, Main Drum or Add Drum.

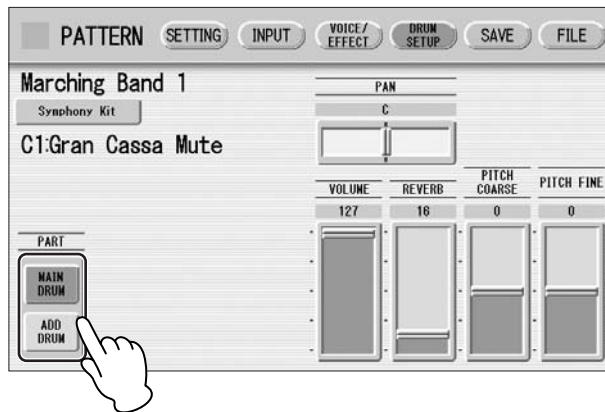

- 3 Press the appropriate key (the key to which the instrument to be changed is assigned).

The selected instrument's name is shown on the display and you can change its settings.

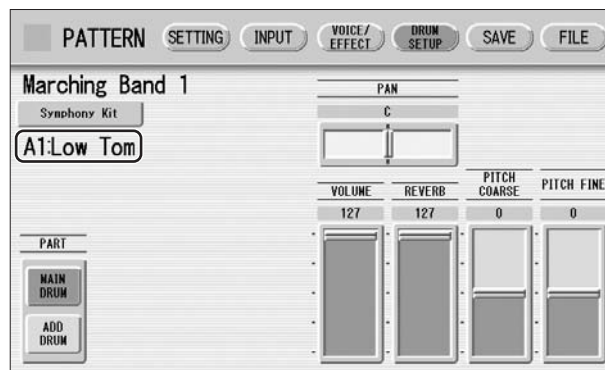

- 4 Adjust the parameters: Pan, Volume, Reverb and Pitch.

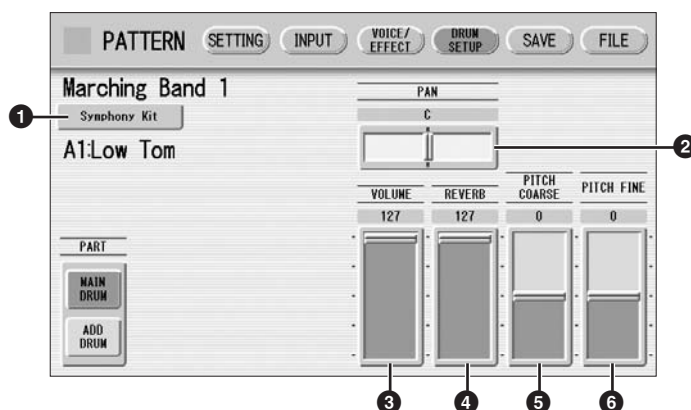

1 Percussion Kit Name

Indicates the currently selected kit. Pressing this button calls up the Percussion Kit list, letting you select the desired kit. When you change the kit, the instruments you have already entered are replaced with the instruments of the newly selected kit.



Reference Page

Percussion Kit List
(page 171)

2 PAN

Determines the position of the currently selected instrument in the stereo image.

Range: L63 – R63

3 VOLUME

Determines the volume of the currently selected instrument.

Range: 0 – 127

4 REVERB

Determines the amount of reverb applied to the currently selected instrument.

Range: 0 – 127

5 PITCH COARSE

Determines the pitch of the currently selected instrument, adjustable in semitone (100-cent) steps.

Range: -64 – +63

6 PITCH FINE

Determines the pitch of the currently selected instrument, adjustable in 1-cent steps, allowing more detailed tuning of the instrument than in PITCH COARSE (5) above.

Range: -64 – +63

Saving Rhythm Patterns

You can save your newly created rhythm pattern as a User Rhythm, up to a maximum of 48 patterns.

1 If necessary, confirm the contents of the rhythm you want to save.

Confirming rhythm patterns before saving

The rhythm pattern you have created will be saved with 15 sections collectively into one rhythm. Before saving, we recommend that you confirm the contents of each section.

Example: When saving the Main A and Main B sections you have created into one user rhythm

First select “Main A” by using the [SECTION] button on the SETTING Page, then press the [START] button on the panel. This lets you hear the Main A pattern you have created. Confirm that the rhythm pattern is what you want to save as Main A. Next, select “Main B” by using the [SECTION] button, then play it back and confirm that this is what you want to save as Main B.

If the Main A and/or Main B patterns contain undesired data or no data, create the desired data by using the Assemble function (page 148).

After confirming the desired section (Main A and Main B here), we recommend that you confirm that all other sections contain no data. If unnecessary data is contained in some sections which you don't want to save, delete that unnecessary data. This can reduce the data size of the user rhythm.

2 Press the [SAVE] button at the top right of the display to call up the SAVE Page.

If the rhythm is playing, it will automatically be stopped.

3 Select the User Rhythm number to which you wish to save.

The following display appears, prompting confirmation of the operation.

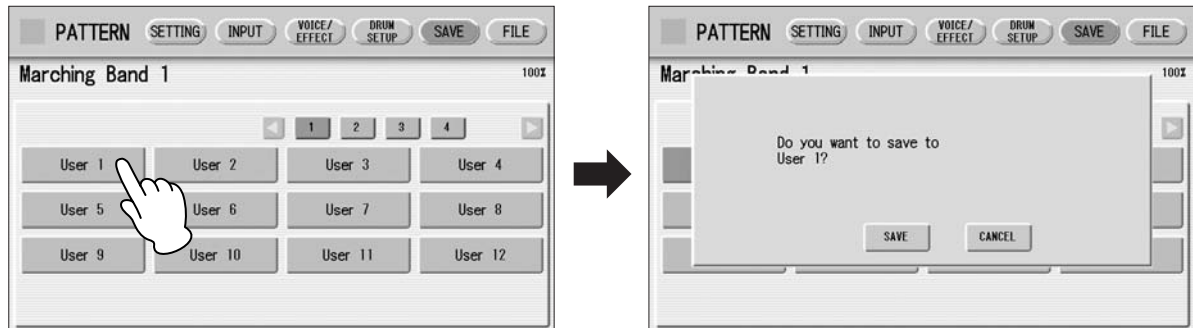

4 Press the [SAVE] button to save the pattern, or press [CANCEL] to abort the operation.

Remaining Memory (amount of memory available for storing rhythms) is shown on the display as a percentage.



Reference Page

Confirming rhythm patterns before saving (page 167)

CLEAR PART (page 149)

If a “Data full” message appears when you press the [SAVE] button, the pattern cannot be saved because of lack of available memory space. If this occurs, check through all fifteen sections for any unnecessary data. After erasing some of the less necessary data, try to save the pattern again.

To avoid this, you should periodically check the amount of remaining memory while you are creating your rhythm.

After saving the Rhythm, be sure to quit Rhythm Pattern Program (page 169) before turning the power off. Turning off the Electone without quitting Rhythm Pattern Program erases the User Rhythm you have created.

Quitting the Rhythm Pattern Program

You can quit the Rhythm Pattern Program from any of its display pages.

1 Press the [PATTERN] button.

If a rhythm is playing, it will automatically be stopped.

If you leave Rhythm Pattern Program without having edited any patterns, this simply quits the Rhythm Pattern Program.

If you have not saved the edited pattern, a message appears, prompting confirmation of the operation.

2 Select [EXIT] to leave Rhythm Pattern Program, or [CANCEL] to abort the operation and return to the previous display.



When you leave the Rhythm Pattern Program, the square at the top left in the display turns light blue for a few seconds, indicating that data is currently being saved. Do not turn the power off while the data is being saved.

Recalling User Rhythm Patterns

The User rhythms you have created in the Rhythm Pattern Program can be selected and played from the User buttons in the panel Rhythm section. Refer to Chapter 5, “Selecting rhythms from the User buttons” (page 58).

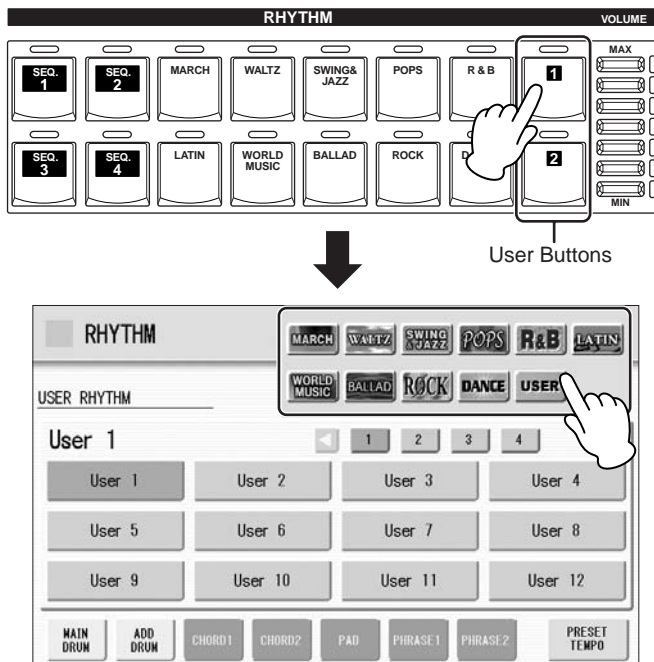

Selecting Rhythm from an External Media

You can load rhythms from a USB flash memory or other external media and edit and save them as User Rhythms. Data that can be loaded includes not only that of the Electone, but also all Style File Format files.

- 1 Insert the media which contains the desired pattern into the USB TO DEVICE terminal.**
- 2 Press the [PATTERN] button on the panel.**
- 3 Press [FILE] at the top right in the display.**
If you open the FILE Page while the rhythm is playing, the rhythm will automatically be stopped.
- 4 Press the [SELECT] button to select the desired pattern file.**
The method for selecting a file is the same as that in the M.D.R. section. See page 103 for more information.

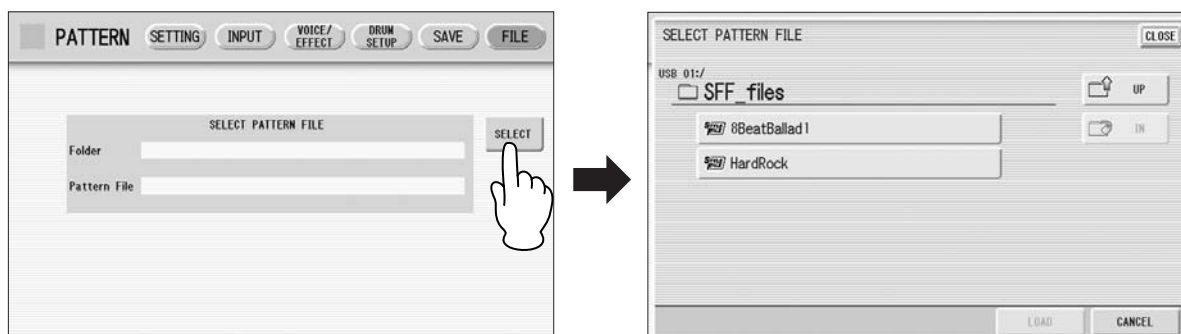

- 5 Press the [LOAD] button to load the pattern.**
To edit the loaded pattern, go to the INPUT Page (page 152), then save your created pattern(s) as a User Rhythm (page 167).

About file types that can be loaded to the Electone

This Electone is compatible with Style File Format data. The Style File Format (SFF) is Yamaha's original style data format, which uses a unique conversion system to provide high-quality automatic accompaniment based on a wide range of chord types. In this format, each rhythm pattern (called a "style") is made up of fifteen sections (Intro 1 – 3, Main A – D, Fill In A – D, Break, Ending 1 – 3) as rhythm pattern variations. Each of these fifteen sections in turn has eight different parts, made up of MIDI sequence data. You can load any patterns (styles) which have been created by an SFF-compatible instrument. Instruments compatible with SFF have the Style File Logo on the panel.



Percussion Kit List



		Standard Kit 1 Live!Std Kit Live!Std+P Kit	Standard Kit 2 Live!Funk Kit Live!Funk+P Kit	Hit Kit	Room Kit	Rock Kit	Electro Kit
Lower Keyboard	C-1	C#-1	Surdo Mute	Surdo Mute	Surdo Mute	Surdo Mute	Surdo Mute
	D-1		Surdo Open	Surdo Open	Surdo Open	Surdo Open	Surdo Open
	D#-1		Hi Q	Hi Q	Hi Q	Hi Q	Hi Q
	E-1		Whip Slap	Whip Slap	Whip Slap	Whip Slap	Whip Slap
	F-1		Scratch H	Scratch H	Scratch H	Scratch H	Scratch H
	F#-1		Scratch L	Scratch L	Scratch L	Scratch L	Scratch L
	G-1		Finger Snap	Finger Snap	Finger Snap	Finger Snap	Finger Snap
	G#-1		Click Noise	Click Noise	Click Noise	Click Noise	Click Noise
	A-1		Metronome Click	Metronome Click	Metronome Click	Metronome Click	Metronome Click
	A#-1		Metronome Bell	Metronome Bell	Metronome Bell	Metronome Bell	Metronome Bell
	B-1		Seq Click L	Seq Click L	Seq Click L	Seq Click L	Seq Click L
	C0		Seq Click H	Seq Click H	Seq Click H	Seq Click H	Seq Click H
	C#0		Brush Tap	Brush Tap	Brush Tap	Brush Tap	Brush Tap
	D0		Brush Swirl*	Brush Swirl*	Brush Swirl*	Brush Swirl*	Brush Swirl*
	D#0		Brush Slap	Brush Slap	Brush Slap	Brush Slap	Brush Slap
	E0		Brush Tap Swirl*	Brush Tap Swirl*	Brush Tap Swirl*	Brush Tap Swirl*	Reverse Cymbal*
	F0		Snare Roll*	Snare Roll*	Snare Roll*	Snare Roll*	Snare Roll*
	F#0		Castanet	Castanet	Castanet	Castanet	Hi Q 2
	G0		Snare Soft	Snare Soft 2	Snare Electro	Snare Soft	Snare Noisy
	G#0		Sticks	Sticks	Sticks	Sticks	Sticks
	A0		Kick Soft	Kick Soft	Kick Tight L	Kick Soft	Kick Soft
	A#0		Open Rim Shot	Open Rim Shot H	Snare Pitched	Open Rim Shot	Open Rim Shot
	B0		Kick Tight	Kick Tight	Kick Wet	Kick Tight	Kick 2
	C1		Kick	Kick Short	Kick Tight H	Kick	Kick Gate
	C#1		Side Stick	Side Stick Light	Stick Ambient	Side Stick	Side Stick
	D1		Snare	Snare Short	Snare Ambient	Snare Snappy	Snare Rock
	D#1		Hand Clap	Hand Clap	Hand Clap	Hand Clap	Hand Clap
	E1		Snare Tight	Snare Tight H	Snare Tight 2	Snare Tight Snap	Snare Rock Tight
	F1		Floor Tom L	Floor Tom L	Hybrid Tom 1	Tom Room 1	Tom Rock 1
	F#1		Hi-Hat Closed	Hi-Hat Closed	Hi-Hat Closed 2	Hi-Hat Closed	Hi-Hat Closed
	G1		Floor Tom H	Floor Tom H	Hybrid Tom 2	Tom Room 2	Tom Rock 2
	G#1		Hi-Hat Pedal	Hi-Hat Pedal	Hi-Hat Pedal 2	Hi-Hat Pedal	Hi-Hat Pedal
A1		Low Tom	Low Tom	Hybrid Tom 3	Tom Room 3	Tom Rock 3	
A#1		Hi-Hat Open	Hi-Hat Open	Hi-Hat Open 2	Hi-Hat Open	Hi-Hat Open	
B1		Mid Tom L	Mid Tom L	Hybrid Tom 4	Tom Room 4	Tom Rock 4	
C2		Mid Tom H	Mid Tom H	Hybrid Tom 5	Tom Room 5	Tom Rock 5	
C#2		Crash Cymbal 1	Crash Cymbal 1	Crash Cymbal 1	Crash Cymbal 1	Crash Cymbal 1	
D2		High Tom	High Tom	Hybrid Tom 6	Tom Room 6	Tom Rock 6	
D#2		Ride Cymbal 1	Ride Cymbal 1	Ride Cymbal 1	Ride Cymbal 1	Ride Cymbal 1	
E2		Chinese Cymbal	Chinese Cymbal	Chinese Cymbal	Chinese Cymbal	Chinese Cymbal	
F2		Ride Cymbal Cup	Ride Cymbal Cup	Ride Cymbal Cup	Ride Cymbal Cup	Ride Cymbal Cup	
F#2		Tambourine	Tambourine	Tambourine Light	Tambourine	Tambourine	
G2		Splash Cymbal	Splash Cymbal	Splash Cymbal	Splash Cymbal	Splash Cymbal	
G#2		Cowbell	Cowbell	Cowbell	Cowbell	Cowbell	
A2		Crash Cymbal 2	Crash Cymbal 2	Crash Cymbal 2	Crash Cymbal 2	Crash Cymbal 2	
A#2		Vibraslap	Vibraslap	Vibraslap	Vibraslap	Vibraslap	
B2		Ride Cymbal 2	Ride Cymbal 2	Ride Cymbal 2	Ride Cymbal 2	Ride Cymbal 2	
C3		Bongo H	Bongo H	Bongo H	Bongo H	Bongo H	
C#3		Bongo L	Bongo L	Bongo L	Bongo L	Bongo L	
D3		Conga H Mute	Conga H Mute	Conga H Mute	Conga H Mute	Conga H Mute	
D#3		Conga H Open	Conga H Open	Conga H Open	Conga H Open	Conga H Open	
E3		Conga L	Conga L	Conga L	Conga L	Conga L	
F3		Timbale H	Timbale H	Timbale H	Timbale H	Timbale H	
F#3		Timbale L	Timbale L	Timbale L	Timbale L	Timbale L	
G3		Agogo H	Agogo H	Agogo H	Agogo H	Agogo H	
G#3		Agogo L	Agogo L	Agogo L	Agogo L	Agogo L	
A3		Cabasa	Cabasa	Cabasa	Cabasa	Cabasa	
A#3		Maracas	Maracas	Maracas	Maracas	Maracas	
B3		Samba Whistle H*	Samba Whistle H*	Samba Whistle H*	Samba Whistle H*	Samba Whistle H*	
C4		Samba Whistle L*	Samba Whistle L*	Samba Whistle L*	Samba Whistle L*	Samba Whistle L*	
C#4		Guiro Short	Guiro Short	Guiro Short	Guiro Short	Guiro Short	
D4		Guiro Long*	Guiro Long*	Guiro Long*	Guiro Long*	Guiro Long*	
D#4		Claves	Claves	Claves	Claves	Claves	
E4		Wood Block H	Wood Block H	Wood Block H	Wood Block H	Wood Block H	
F4		Wood Block L	Wood Block L	Wood Block L	Wood Block L	Wood Block L	
F#4		Cuica Mute	Cuica Mute	Cuica Mute	Cuica Mute	Scratch H 2	
G4		Cuica Open	Cuica Open	Cuica Open	Cuica Open	Scratch L 2	
G#4		Triangle Mute	Triangle Mute	Triangle Mute	Triangle Mute	Triangle Mute	
A4		Triangle Open	Triangle Open	Triangle Open	Triangle Open	Triangle Open	
A#4		Shaker	Shaker	Shaker	Shaker	Shaker	
B4		Jingle Bells	Jingle Bells	Jingle Bells	Jingle Bells	Jingle Bells	
C5		Bell Tree	Bell Tree	Bell Tree	Bell Tree	Bell Tree	
D5							
D#5							
E5							
F5							
F#5							
G5							

Lower Keyboard

Upper Keyboard

*: Indicates an instrument which requires the Gate Time setting.

Lower Keyboard

Upper Keyboard

		Analog Kit	Dance Kit	Jazz Kit	Brush Kit Live!Brush Kit Live!Brush+P Kit	Symphony Kit	EL Kit 1
C-1	C#-1	Surdo Mute	Kick Dance 1	Surdo Mute	Surdo Mute	Surdo Mute	Scratch
D-1		Surdo Open	Kick Dance 2	Surdo Open	Surdo Open	Surdo Open	Concert BD
	D#-1	Hi Q	Hi Q	Hi Q	Hi Q	Hi Q	Noise Percussion
E-1		Whip Slap	Whip Slap*	Whip Slap	Whip Slap	Whip Slap	Bass Drum March
F-1		Scratch H	Scratch Dance 1*	Scratch H	Scratch H	Scratch H	Analog BD Short
	F#-1	Scratch L	Scratch Dance 2*	Scratch L	Scratch L	Scratch L	Synth Tom 3
G-1		Finger Snap	Finger Snap	Finger Snap	Finger Snap	Finger Snap	Analog BD Long
	G#-1	Click Noise	Click Noise	Click Noise	Click Noise	Click Noise	Synth Tom 2
A-1		Metronome Click	Dance Perc 1	Metronome Click	Metronome Click	Metronome Click	Synth Bass Drum
	A#-1	Metronome Bell	Reverse Dance 1	Metronome Bell	Metronome Bell	Metronome Bell	Synth Tom 1
B-1		Seq Click L	Dance Perc 2	Seq Click L	Seq Click L	Seq Click L	Bass Drum Attack
		Seq Click H	Hi Q Dance 1	Seq Click H	Seq Click H	Seq Click H	Bass Drum Heavy
C0	C#0	Brush Tap	Snare Analog 3	Brush Tap	Brush Tap	Brush Tap	Tom 4
D0		Brush Swirl*	Vinyl Noise*	Brush Swirl*	Brush Swirl*	Brush Swirl*	Bass Drum Light
	D#0	Brush Slap	Snare Analog 4	Brush Slap	Brush Slap	Brush Slap	Tom 3
E0		Reverse Cymbal*	Reverse Cymbal*	Brush Tap Swirl*	Brush Tap Swirl*	Brush Tap Swirl*	Orchestra Cymbal
F0		Snare Roll*	Reverse Dance 2'	Snare Roll*	Snare Roll*	Snare Roll*	Snare Drum Roll*
	F#0	Hi Q 2	Hi Q 2	Castanet		Castanet	Tom 2
G0		Snare Noisy 4	Snare Techno	Snare Jazz H	Brush Slap 2	Snare Soft	SD Brush Roll
	G#0	Sticks	Snare Dance 1	Sticks	Sticks	Sticks	Tom 1
A0		Kick 3	Kick Techno Q	Kick Soft	Kick Soft	Kick Soft 2	SD Brush Shot 2
	A#0	Open Rim Shot	Rim Gate	Open Rim Shot	Open Rim Shot	Open Rim Shot	Tom Brush Shot 4
B0		Kick Anlg Short	Kick Techno L	Kick Tight	Kick Tight	Gran Cassa	SD Brush Shot 1
		Kick Analog	Kick Techno	Kick Jazz		Gran Cassa Mute	Snare Drum Heavy
C1	C#1	Side Stick Anlg	Side Stick Anlg	Side Stick Light	Side Stick Light	Side Stick	Tom Brush Shot 3
D1		Snare Analog	Snare Clap	Snare Jazz L	Brush Slap 3	Band Snare	Snare Drum Light
	D#1	Hand Clap	Dance Clap	Hand Clap	Hand Clap	Hand Clap	Tom Brush Shot 2
E1		Snare Analog 2	Snare Dry	Snare Jazz M	Brush Tap 2	Band Snare 2	SD Accent 2
F1		Tom Analog 1	Tom Dance 1	Floor Tom L	Tom Brush 1	Floor Tom L	SD Accent 1
	F#1	Hat Close Analog	Hi-Hat Closed 3	Hi-Hat Closed	Hi-Hat Closed	Hi-Hat Closed	Tom Brush Shot 1
G1		Tom Analog 2	Tom Dance 2	Floor Tom H	Tom Brush 2	Floor Tom H	SD Reverb 2
	G#1	Hat Close Anlg 2	Hat Close Anlg 3	Hi-Hat Pedal	Hi-Hat Pedal	Hi-Hat Pedal	Snare Drum Rim 2
A1		Tom Analog 3	Tom Dance 3	Low Tom	Tom Brush 3	Low Tom	SD Reverb 1
	A#1	Hat Open Analog	Hi-Hat Open 3	Hi-Hat Open	Hi-Hat Open	Hi-Hat Open	Snare Drum Rim 1
B1		Tom Analog 4	Tom Dance 4	Mid Tom L	Tom Brush 4	Mid Tom L	Synth Snare Drum
		Tom Analog 5	Tom Dance 5	Mid Tom H	Tom Brush 5	Mid Tom H	Analog SD
C2	C#2	Crash Analog	Crash Analog	Crash Cymbal 1	Crash Cymbal 1	Hand Cymbal	Triangle Mute
D2		Tom Analog 6	Tom Dance 6	High Tom	Tom Brush 6	High Tom	Tambourine
	D#2	Ride Cymbal 1	Ride Cymbal 1	Ride Cymbal 1	Ride Cymbal 1	Hand Cymbal S	Triangle Open
E2		Chinese Cymbal	Chinese Cymbal	Chinese Cymbal	Chinese Cymbal	Chinese Cymbal	Castanet
F2		Ride Cymbal Cup	Ride Cymbal Cup	Ride Cymbal Cup	Ride Cymbal Cup	Ride Cymbal Cup	Claves
	F#2	Tambourine	Tambourine Anlg	Tambourine		Tambourine	
G2		Splash Cymbal	Splash Cymbal	Splash Cymbal	Splash Cymbal	Splash Cymbal	Cabasa
	G#2	Cowbell Analog	Cowbell Dance	Cowbell	Cowbell	Cowbell	
A2		Crash Cymbal 2	Crash Cymbal 2	Crash Cymbal 2	Crash Cymbal 2	Hand Cymbal 2	Finger Snap
	A#2	Vibraslap	Vibraslap Analog	Vibraslap	Vibraslap	Vibraslap	
B2		Ride Cymbal 2	Ride Analog	Ride Cymbal 2	Ride Cymbal 2	Hand Cymbal 2 S	Hand Claps
C3	C#3	Bongo H	Bongo Analog H	Bongo H	Bongo H	Bongo H	Crash Cymbal 2
D3		Bongo L	Bongo Analog L	Bongo L	Bongo L	Bongo L	Hi-Hat Close
	D#3	Conga Analog H	Conga Analog H	Conga H Mute	Conga H Mute	Conga H Mute	Crash Cymbal 1
E3		Conga Analog M	Conga Analog M	Conga H Open	Conga H Open	Conga H Open	Hi-Hat Open
		Conga Analog L	Conga Analog L	Conga L	Conga L	Conga L	Crash Cym Mute
F3		Timbale H	Timbale H	Timbale H	Timbale H	Timbale H	Ride Cymbal 2
	F#3	Timbale L	Timbale L	Timbale L	Timbale L	Timbale L	Hi-Hat Pedal 2
G3		Agogo H	Agogo H	Agogo H	Agogo H	Agogo H	Ride Cymbal 1
	G#3	Agogo L	Agogo L	Agogo L	Agogo L	Agogo L	Hi-Hat Pedal 1
A3		Cabasa	Cabasa	Cabasa	Cabasa	Cabasa	Ride Cymbal Cup
	A#3	Maracas 2	Maracas 2	Maracas	Maracas	Maracas	
B3		Samba Whistle H*	Samba Whistle H*	Samba Whistle H*	Samba Whistle H*	Samba Whistle H*	Cym Brush Shot
		Samba Whistle L*	Samba Whistle L*	Samba Whistle L*	Samba Whistle L*	Samba Whistle L*	Cymbal March
C4	C#4	Guiro Short	Guiro Short	Guiro Short	Guiro Short	Guiro Short	Analog HH Close
D4		Guiro Long*	Guiro Long*	Guiro Long*	Guiro Long*	Guiro Long*	Orch Cymbal Roll
	D#4	Claves 2	Claves 2	Claves	Claves	Claves	Analog HH Open
E4		Wood Block H	Dance Perc 3	Wood Block H	Wood Block H	Wood Block H	Orch Cymbal
F4		Wood Block L	Dance Perc 4*	Wood Block L	Wood Block L	Wood Block L	Orch Cymbal Mute
	F#4	Scratch H 2	Dance Breath 1	Cuica Mute	Cuica Mute	Cuica Mute	
G4		Scratch L 2	Dance Breath 2*	Cuica Open	Cuica Open	Cuica Open	Tam-Tam
	G#4	Triangle Mute	Triangle Mute	Triangle Mute	Triangle Mute	Triangle Mute	
A4		Triangle Open	Triangle Open	Triangle Open	Triangle Open	Triangle Open	
	A#4	Shaker	Shaker	Shaker	Shaker	Shaker	
B4		Jingle Bells	Jingle Bells	Jingle Bells	Jingle Bells	Jingle Bells	
C5	C#5	Bell Tree	Bell Tree	Bell Tree	Bell Tree	Bell Tree	
D5							
	D#5						
E5							
F5							
	F#5						
G5							

*: Indicates an instrument which requires the Gate Time setting.



Lower Keyboard

Upper Keyboard

		EL Kit 2	Live!Studio Kit	SFX Kit 1	SFX Kit 2	Arabic Kit	Cuban Kit	Pop Latin Kit
C-1	C♯-1	Maracas High	Surdo Mute					
D-1		Surdo Mute	Surdo Open					
	D♯-1	Maracas Low	Hi Q					
E-1		Surdo Muff	Whip Slap					
F-1		Surdo Rim	Scratch H					
	F♯-1	Cuica High	Scratch L					Hand Clap
G-1		Surdo Open	Finger Snap					
	G♯-1	Cuica Middle	Click Noise					
A-1		Tamborim Mute	Metronome Click					
	A♯-1	Cuica Low	Metronome Bell				Conga H Tip	Conga H Tip
B-1		Tamborim Open	Seq Click L				Conga H Heel	Conga H Heel
		Pandeiro	Seq Click H			Nakarazan Dom	Conga H Open	Conga H Open
C0	C♯0	Bongo High	Brush Tap			Cabasa	Conga H Mute	Conga H Mute
D0		Conga Slide	Brush Swirl*			Nakarazan Edge	Conga H SlapOpen	Conga H SlapOpen
	D♯0	Bongo Low	Brush Slap			Hager Dom	Conga H Slap	Conga H Slap
E0		Conga Slap	Brush Tap Swirl*			Hager Edge	Conga H SlapMute	Conga H SlapMute
F0		Conga Muff	Snare Roll*			Bongo H	Conga L Tip	Conga L Tip
	F♯0	Bongo Mute	Castanet			Bongo L	Conga L Heel	Conga L Heel
G0		Conga High	Snare Studio L			Conga H Mute	Conga L Open	Conga L Open
	G♯0	Bongo Slap	Sticks			Conga H Open	Conga L Mute	Conga L Mute
A0		Conga Low	Kick Ambience H			Conga L	Conga L SlapOpen	Conga L SlapOpen
	A♯0		Open Rim Shot			Zagrouda H	Conga L Slap	Conga L Slap
B0		Timbale 1 High	Kick Ambience L			Zagrouda L*	Conga L Slide*	Conga L Slide*
		Timbale 1 Low	Kick Studio	Cutting Noise 1*	Phone Call*	Kick Soft	Bongo H Open 1 f	Bongo H Open 1 f
C1	C♯1		Side Stick	Cutting Noise 2*	Door Squeak*	Side Stick	Bongo H Open 3 f	Bongo H Open 3 f
D1		Timbale 2 High	Snare Studio M		Door Slam*	Snare Soft	Bongo H Rim	Bongo H Rim
	D♯1		Hand Clap	String Slap*	Scratch Cut*	Arabic Hand Clap	Bongo H Tip	Bongo H Tip
E1		Timbale 2 Low	Snare Studio L		Scratch H 3*	Snare Drum	Bongo H Heel	Bongo H Heel
F1		Timbale 3 High	Floor Tom L		Wind Chime*	Floor Tom L	Bongo H Slap	Bongo H Slap
	F♯1	Woodblock High	Hi-Hat Closed		Telephone Ring*	Hi-Hat Closed	Bongo L Open 1 f	Bongo L Open 1 f
G1		Timbale 3 Low	Floor Tom H			Floor Tom H	Bongo L Open 3 f	Bongo L Open 3 f
	G♯1	Woodblock Mid	Hi-Hat Pedal			Hi-Hat Pedal	Bongo L Rim	Bongo L Rim
A1		Timbale 4 High	Low Tom			Low Tom	Bongo L Tip	Bongo L Tip
	A♯1	Woodblock Low	Hi-Hat Open			Hi-Hat Open	Bongo L Heel	Bongo L Heel
B1		Timbale 4 Low	Mid Tom L			Mid Tom L	Bongo L Slap	Bongo L Slap
		Vibraslap	Mid Tom H			Mid Tom H	Timbale L Open	Timbale L Open
C2	C♯2	Triangle Mute	Crash Cymbal 1			Crash Cymbal 1		
D2		Tambourine	High Tom			High Tom		
	D♯2	Triangle Open	Ride Cymbal 1			Ride Cymbal 1		
E2		Castanet	Chinese Cymbal	Flute Key Click*	CarEngnIgnition*	Crash Cymbal 2		
F2		Claves	Ride Cymbal Cup		Car Tires Squeal*	Duhulla Dom	Paila L	Paila L
	F♯2		Tambourine		Car Passing*	Tambourine	Timbale H Open	Timbale H Open
G2		Cabasa	Splash Cymbal		Car Crash*	Duhulla Tak		
	G♯2		Cowbell		Siren*	Cowbell		
A2		Finger Snap	Crash Cymbal 2		Train*	Duhulla Sak		
	A♯2		Vibraslap		Jet Plane*	Claves		
B2			Ride Cymbal 2		Starship*	Doff Dom	Paila H	Paila H
C3	C♯3	Wind Bell Down	Bongo H		Burst*	Katem Dom	Cowbell Top	Cowbell Top
D3		Agogo High	Bongo L		Roller Coaster*	Katem Tak		
	D♯3	Wind Bell Up	Conga H Mute		Submarine*	Katem Sak		
E3		Agogo Low	Conga H Open			Katem Tak		
F3		Bells	Conga L			Doff Tak	Guiro Short	Guiro Short
	F♯3	Cowbell 4	Timbale H			Tabla Dom	Guiro Long*	Guiro Long*
G3		Shaker	Timbale L			Tabla Tak 1		
	G♯3	Cowbell 3	Agogo H			Tabla Tik		
A3		Guiro Short	Agogo L	Shower*	Laugh*	Tabla Tak 2	Tambourine	Tambourine
	A♯3	Cowbell 2	Cabasa	Thunder*	Scream*	Tabla Sak		
B3		Guiro Long	Maracas	Wind*	Punch*	Tabla Roll Edge*		
		Cowbell 1	Samba Whistle H*	Stream*	Heart Beat*	Tabla Flam		
C4	C♯4	Taiko 2	Samba Whistle L*	Bubble*	Foot Steps*	Sagat 1	Maracas	Maracas
D4		Ohndaiko 2	Guiro Short	Feed*		Tabel Dom	Shaker	Shaker
	D♯4	Taiko 1	Guiro Long*			Sagat 3	Cabasa	Cabasa
E4		Ohndaiko 1	Claves			Tabel Tak		Cuica Mute
F4		Ohtsuzumi 2	Wood Block H			Sagat 2		Cuica Open
	F♯4	Ohtsuzumi 1	Wood Block L			Rik Dom		
G4		Kakegoe 3	Cuica Mute			Rik Tak 2		
	G♯4	Kotsuzumi 4	Cuica Open			Rik Finger 1		
A4		Kakegoe 2	Triangle Mute			Rik Tak 1		
	A♯4	Kotsuzumi 3	Triangle Open			Rik Finger 2		Triangle Mute
B4		Kakegoe 1	Shaker			Rik BrassTremolo*		Triangle Open
		Kotsuzumi 2	Jingle Bells			Rik Sak		
C5	C♯5	Kotsuzumi 1	Bell Tree	Dog*	Machine Gun*	Rik Tik		Wind Chime
D5				Horse*	Laser Gun*			
	D♯5			Bird Tweet*	Explosion*			
E5					Firework*			
F5								
	F♯5			Ghost*				
G5				Maou*				

*: Indicates an instrument which requires the Gate Time setting.

3 Rhythm Sequence Program

With the Rhythm Sequence Program function, you can string together any of the Electone's existing rhythms and the rhythms of your own creation together to make complete rhythm compositions.

You can save four rhythm compositions (each can contain up to 140 bars) to the Sequence buttons on the panel for future recall. Two or more rhythm compositions can be played back in succession, letting you divide a song into parts and play back the rhythm data as desired. Here are a couple of example applications:

- When you want to play more than two songs in a medley, save the rhythm composition for each song to a separate sequence button. You can then recall each desired song by simply pressing the corresponding sequence button to which the song is saved.
- When you want to practice a song in separate sections (for example, separately practicing the verse, chorus and bridge), divide the song into the relevant parts. For example, save the intro part to the [SEQ. 1] button, the main chorus part to the [SEQ. 2] button, the ending to the [SEQ. 3] button, and so on. Then, recall the desired part simply by pressing the appropriate sequence button. You can also play through a song by recalling all the parts in sequence.

Selecting a Sequence

There are two ways to program a rhythm sequence: creating your own sequence from scratch, or copying and editing an existing sequence that is similar to the sequence you want to create.



Reference Page

Programming a Sequence (page 175)

Copying a Sequence (page 183)

- 1 Press the [SEQUENCE] button in the DISPLAY SELECT section. The MENU Page of the Sequence display appears.

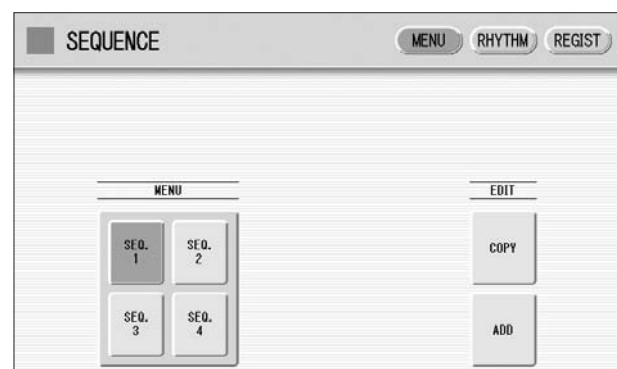
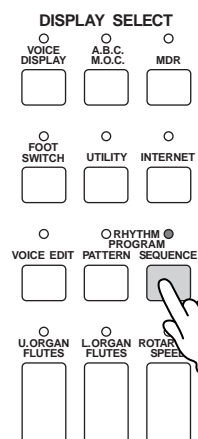

Any rhythm currently playing will automatically be stopped when you call up the Rhythm Sequence Program function.

- 2 Press one of the Sequence buttons ([SEQ. 1] – [SEQ. 4]) on the left half in the display to select the rhythm sequence number you want to edit.

The lamp of the selected numbered sequence button in the Rhythm section lights.

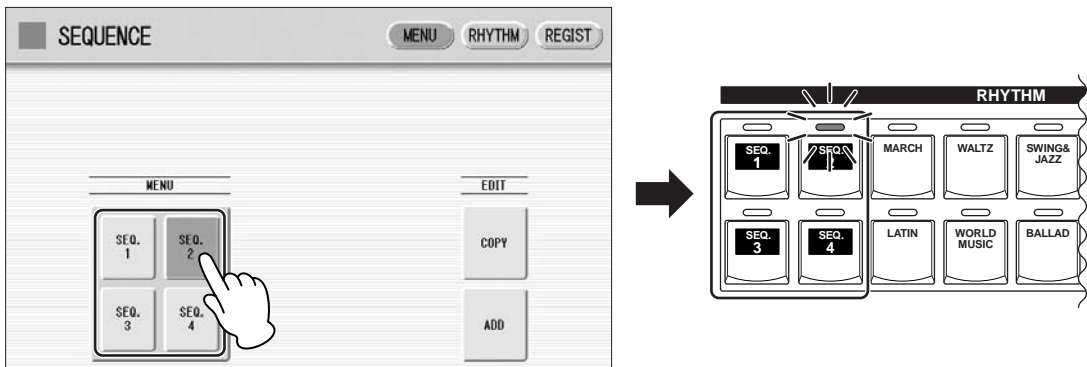

Instead of pressing the Sequence button on the display, you can press one of the sequence buttons in the Rhythm section on the panel to select the sequence number.

This selects the Sequence number, to which a rhythm composition can be saved. If you want to edit existing a rhythm composition, refer to “Copying a Sequence” on page 183. If you want to program a rhythm sequence from scratch, refer to “Programming a Sequence” below.

Programming a Sequence

- 1 Press the [RHYTHM] button at the top right of the display to call up the RHYTHM Page.
- 2 Press the rhythm button corresponding to the rhythm you want to enter to the sequence. If you press User button [1] or [2], you can select a rhythm of your own creation (User rhythm).

The rhythm menu of the selected rhythm button is displayed.

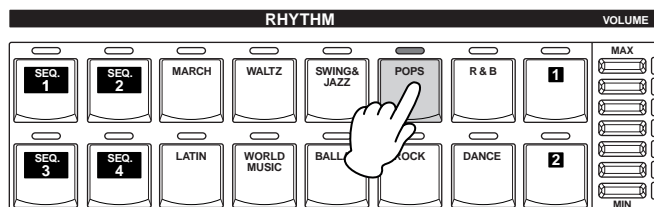

3 Select the desired rhythm from the displayed rhythm menu.

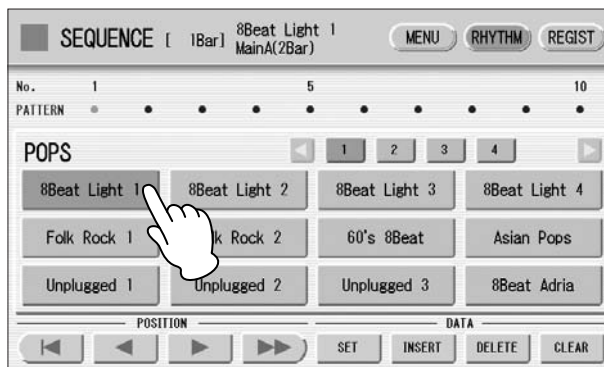

NOTE

When entering an Intro section, check the number of bars at the top of the display.



NOTE

When you press the ENDING [1] button while the Main section is playing back, a fill-in pattern will be called up before the Ending 1 pattern. In the Rhythm Sequence program, however, a fill in pattern is not called up when Ending 1 is entered to the Sequence.

4 Select a rhythm section (Main A – D, Fill in A – D, Intro 1 – 3, Ending 1 – 3, or Break) by pressing one of the rhythm control buttons on the panel.

The selected rhythm and section appears at the top of the display.

5 Press the [SET] button in the display.

One bar of the selected rhythm is entered and its name is displayed as a box in the rhythm row on the display. When the rhythm is entered, the cursor (colored orange) will automatically move to one step right. A maximum of 140 bars can be entered to a single sequence. When you select an ending pattern and press the [SET] button, an entire ending pattern (more than one bar) is entered. You cannot enter a rhythm after an ending pattern.

6 Repeat steps 2 through 5 above to enter the rhythm and create your own rhythm composition.

Turning the power off before quitting or closing the Rhythm Sequence Program erases any sequences you have made. Before turning the power off, quit the Rhythm Sequence Program (page 181).

Auditioning a Sequence

You can play a sequence you are editing at any time to audition the changes.

- 1 **Move the cursor to the desired position for playback.**
Move the cursor by using the Data Control dial, or the POSITION buttons on the display.

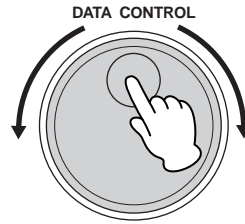
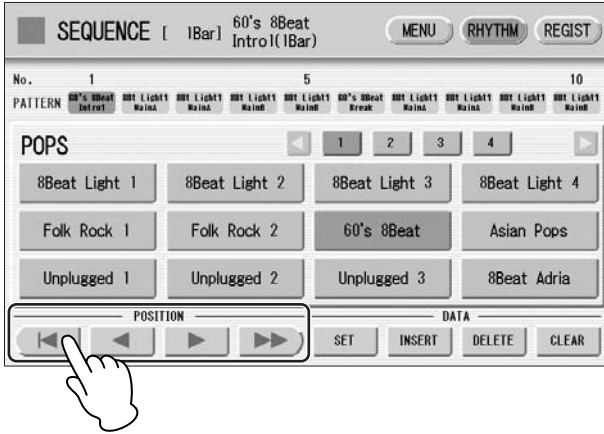

- 2 **Press the rhythm [START] button on the panel.**

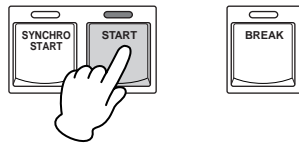

The Sequence plays back. Pressing the [START] button again stops playback.



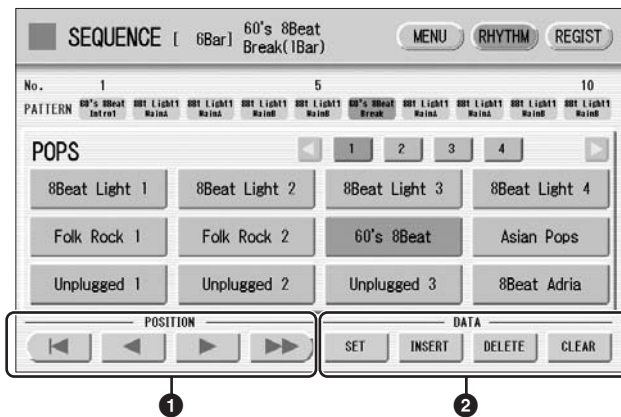

Editing an Existing Rhythm Sequence

You can insert a new rhythm between the rhythms you have already entered, or delete the entered rhythm from the sequence.



1 POSITION

These are cursor controls for moving the cursor (colored orange) along the rhythm row in the display.

-  Moves the cursor to the first position.
-  Moves the cursor one step to the left.
-  Moves the cursor one step to the right.
-  Moves the cursor five steps to the right.

2 DATA

These are data controls for entering rhythms and deleting existing rhythms in the rhythm row.



NOTE

When you insert an ending pattern into the editing sequence, any existing rhythm data that follows an Ending pattern is automatically deleted.

SET

For initially entering a rhythm to an empty position in the rhythm row, or for replacing a pattern at the cursor position. Pressing the [SET] button enters the rhythm selected from the rhythm menu to the cursor position.

This operation is not available between measures of an ending pattern.

INSERT

For inserting a rhythm before the current cursor position. The new rhythm is entered just before the cursor position and all other rhythms to the right of the cursor are moved to accommodate the new number. This operation is not available between measures of an ending pattern.

Additional rhythms cannot be entered beyond the Rhythm sequence function's capacity of 140. If the Insert operation results in the rhythm number going over the capacity, a "Data Full" message appears and the operation cannot be executed.

DELETE

For deleting a rhythm at the current cursor position. When the ending pattern is selected, pressing the [DELETE] button deletes the entire ending pattern (more than one bar).

CLEAR

For erasing all patterns entered to the selected sequence.

After selecting [CLEAR], a message appears prompting confirmation of the operation.

Select [CLEAR] to clear the currently selected rhythm sequence, or select [CANCEL] to abort the operation and return to the previous display.

Programming a Registration Sequence

The Registration Sequence feature allows you to have desired Registrations automatically called up in sequence, when playing a Rhythm Sequence. It lets you program the timing (bar/beat/clock) at which the Registration is changed. You can also program the Next Regist function in Registration Sequence.

A Registration Sequence is saved as a part of the corresponding Rhythm Sequence. With this feature, you can have the sounds of the instrument change as desired automatically to match the Rhythm Sequence playback.



NOTE

If you are loading a Registration while a rhythm is playing, the sequence data and User rhythms in the Registration data cannot be loaded.

- 1 Press the [REGIST] button at the top right in the display to call up the Registration Sequence display.

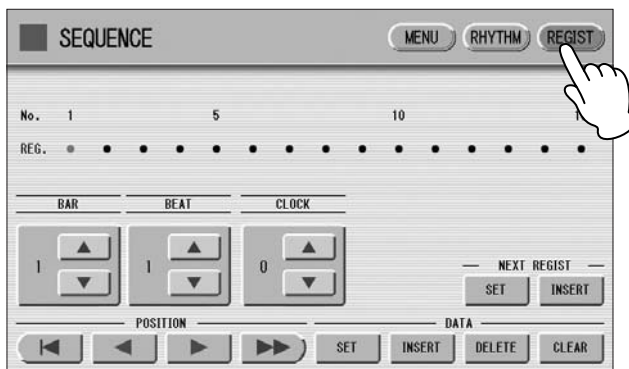

The Registration Sequence is programmed from this display. The entered Registration number is shown along the Registration row in the middle of the display.

- 2 Press the desired numbered button in the Registration Memory section.

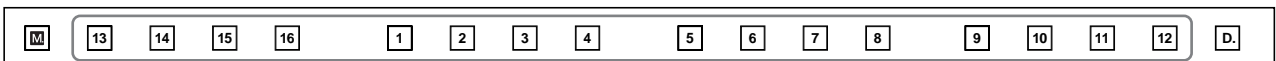

- 3 Using the buttons in the display or the Data Control dial, set the Bar/Beat/Clock position at which you want to change the Registration (1 beat = 96 Clock).

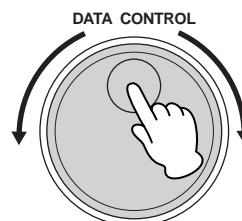
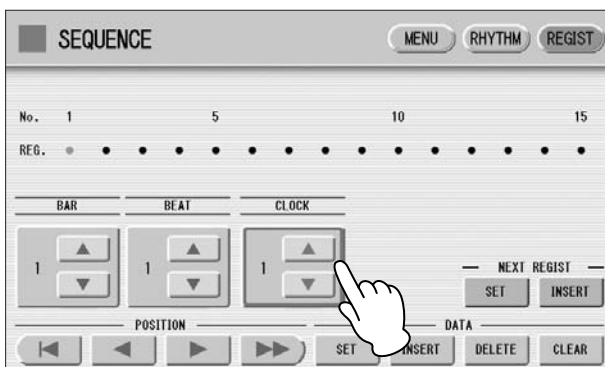



When using the Data Control dial, first press the number you wish to change in the display, then turn the dial.

4 Press the DATA [SET] button in the display.
The Registration number appears in the display (in the timing order), indicating that the Registration is entered. Up to 140 Registrations can be entered. If some Registration numbers are entered to the same Bar/Beat/Clock, the last entered one takes priority.

5 Repeat steps 2 through 4 above to set the Registration Sequence.

Entering Next Regist:

When you program the Next Regist function in Registration Sequence, the next registration data in current song can be loaded automatically just by playing the rhythm sequence.

1 Using the   buttons in the display or the Data Control dial, set the Bar/Beat/Clock position at which you want to enter the Next Regist (1 beat = 96 clock).

2 Press the NEXT REGIST [INSERT] button in the display.
The Next Regist mark  appears at the timing point you set in step 1, indicating that the Next Regist is entered.

Next Regist Loading Time

- Loading Next Regist may take a few seconds (the time may differ depending on the size of the data to be loaded).
- When using a floppy disk instead of USB flash memory, the loading time will be longer than when using USB flash memory.
- Next Registration data can be loaded by two ways: using right footswitch and programming Next Regist in the Registration Sequence. Loading time is the same regardless of which way you load the Next Registration data.

Editing an Existing Registration Sequence

You can move or delete the entered Registration Sequence (Registration number or Next Regist data) from the sequence.

To move an entry:

- 1 Using the **POSITION** buttons, move the cursor and select the data (Registration number or Next Regist) you want to move.
- 2 Change the position by pressing the **Bar/Beat/Clock** buttons in the display.
- 3 To move the Registration number timing, press the **DATA [SET]** button. To move the Next Regist timing, press the **NEXT REGIST [SET]** button.

The position of the Registration number or Next Regist is changed and displayed in the proper order.

To erase an entry:

- 1 Using the **POSITION** buttons, move the cursor and select the data (Registration number or Next Regist) you want to delete.
- 2 Press the **[DELETE]** button to delete the data.

Quitting the Rhythm Sequence Program

You can quit the Rhythm Sequence Program from any of its display pages. When you quit, the sequence you have made will be automatically saved.

To quit the Rhythm Sequence Program:

Press the [SEQUENCE] button on the panel.

The Voice Display appears, indicating that the Rhythm Sequence Program is closed.



When quitting the Rhythm Sequence Program, the square at the top left of the display turns light blue for a few seconds, indicating that the sequence is currently being saved. Do not turn the power off while the sequence is being saved.

Playing Rhythm Sequences

To play any of the rhythm sequences you have created:

- 1 Press the appropriate Sequence button ([SEQ. 1] – [SEQ. 4]) on the panel.

The SEQ button's lamp lights.

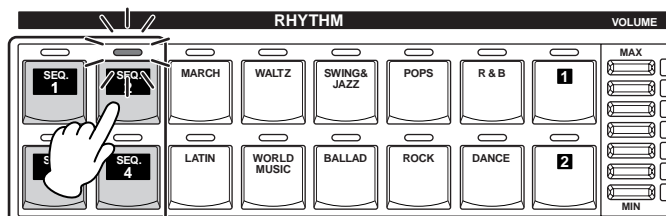

- 2 Press the rhythm [START] button.

The rhythm in the selected sequence starts playback.

When one of the four rhythm sequences is playing, each programmed rhythm that plays is indicated by the lit LED of the Rhythm buttons.

The Registration Memory also changes with the Rhythm Sequence playback, if the sequence includes a Registration Sequence.

Rhythm playback automatically stops when the sequence reaches its end.

If you've stopped rhythm playback in the middle of the sequence, press the [START] button again to resume playback.

Playing All Sequences in Order

You can also have up to all four rhythm sequences automatically play in order, one after another.

- 1 Press the desired Sequence buttons, making sure that all their LEDs are lit.

- 2 Press the rhythm [START] button.

The rhythm sequences start from the lowest number and play in order automatically to the highest number. (For example, if you press Sequence buttons 4, 2 and 1 in that order, the sequences will be played back not in the order you pressed them, but in their numeric order: 1, 2, then 4.) This function effectively allows you to make a long rhythm sequence that exceeds the 140-pattern memory limit of a single sequence.

Pressing one of the SEQ. buttons while a Rhythm Sequence is playing back automatically cancels the pressed sequence, and its LED turns off. You cannot cancel a sequence that is currently playing. The SEQ. lamp goes out when the sequence assigned to it is finished playing.

To start a sequence using the Left Footswitch:

You can start or stop the Rhythm Sequence playback using the left footswitch.

- 1 Press the desired Sequence buttons, making sure that all their LEDs are lit.**
- 2 Press the [FOOT SWITCH] button on the panel to call up the Footswitch display, LEFT Page.**
- 3 Set the control mode of the Footswitch to RHYTHM STOP.**
(See page 185 for information about the Footswitch settings.)
- 4 Press the Left Footswitch with your right foot to turn the sequence on.**

Pressing the Left Footswitch again in the middle of the sequence playback cancels the Rhythm Sequence.

When you are playing a Rhythm Sequence that is made up of several sequences (SEQ. buttons), pressing the Left footswitch turns off the currently playing Rhythm Sequence, and pressing it again starts the next sequence.

Copying a Sequence

You can copy a rhythm sequence stored on a sequence button to another button. You can also add a rhythm sequence to the end of another rhythm sequence.

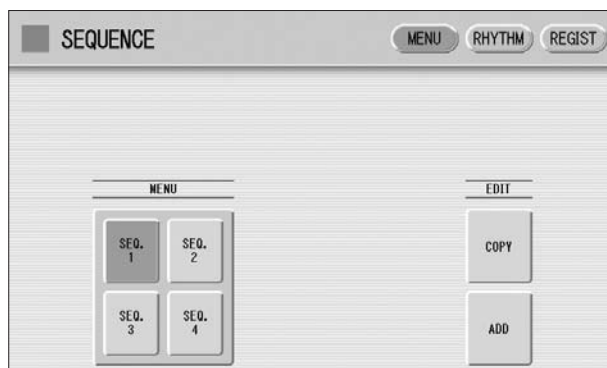

- 1 Press the EDIT [COPY] or [ADD] button in the Sequence Menu page.**

The Copy From or Add From Display appears.

- 2 Select the number of the desired rhythm sequence program to which you want to copy or to which you want to add.**

A message appears prompting confirmation of operation.

- 3 Press the [COPY] or [ADD] button to copy or add the rhythm sequence.**

Press [CANCEL] to abort the operation.

- 4 If necessary, edit the sequence.**

Refer to the section “Editing an Existing Rhythm Sequence” on page 177 and/or “Editing an Existing Registration Sequence” on page 181.



NOTE

If you add a rhythm sequence to another rhythm sequence that has an ending at the end, the section will automatically change to MAIN A and the new sequence will be added after the MAIN A part.

4

Saving Rhythm Pattern and Rhythm Sequence Data to external media

You can save your own rhythm patterns (created in the Rhythm Pattern Program) and Rhythm Sequence (created in the Rhythm Sequence Program) to external media, such as USB flash memory. Refer to the section “Saving Registrations as Registration Data (File)” on page 111 for instructions.

When loading your original Rhythm data from external media back to the Electone, be sure to stop the rhythm if it is playing. Loading cannot be executed when a rhythm is running.

Footswitches, Knee Lever and Expression Pedals

These leg- and foot-operated controls allow you to execute various performance functions and switch the effect on/off, without taking your hands from the keyboard.

Contents

1 Footswitches	185	3 Expression Pedals	190
• Controlling the Rhythm	186	• Controlling Pitch Bend	191
• Controlling Glide	187	• Controlling the Rhythm Tempo	192
• Controlling Rotary Speaker	188		
2 Knee Lever	188		
• Controlling Sustain	188		
• Controlling Melody On Chord	189		
• Controlling Lead Slide	190		
• Controlling the Solo Function	190		

1 Footswitches

The Electone has two Footswitches on the main expression pedal. The Right Footswitch is used for the Registration Shift function. The Left Footswitch can be set to control one of the following functions: Rhythm, Glide, and Rotary speaker. See page 85 for the details of the Registration Shift function or Right Footswitch. The explanation on the Left Footswitch is given here.

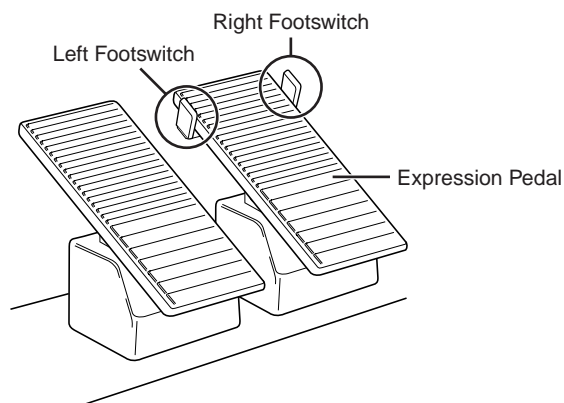

- 1 Press the [FOOT SWITCH] button.
- 2 Press the [LEFT] button at the top right of the display to call up the LEFT Page.



NOTE

When the Next Page function of the score display is assigned to the left foot switch, and if rhythm, glide and/or rotary speaker are assigned to the left foot switch as well, pressing the foot switch performs both the assigned function and the Next Page function. For details on the Next Page function, refer to page 123.

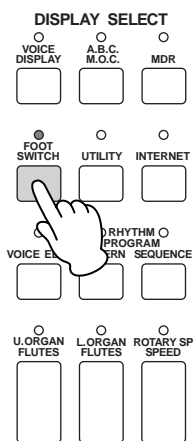

In this display, you can assign the control function to the Left Footswitch: Rhythm, Glide, and Rotary Speaker. If you choose OFF here, the Left Footswitch will not control any function.

Controlling the Rhythm

You can control the rhythm start/stop or switch the rhythm sections by using the Left Footswitch.

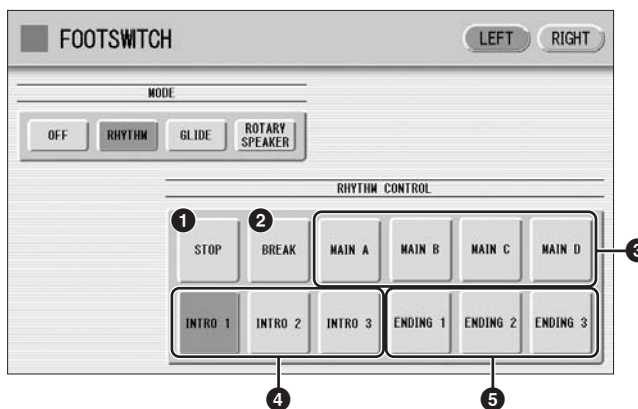

Reference Page

Rhythm Structure (page 52)

1 STOP

Switches the rhythm on/off whenever you press the Footswitch.

2 BREAK

When you press the Footswitch, the Break section turns on. This function corresponds to the [BREAK] button on the panel.

3 MAIN A – MAIN D

These functions correspond to the MAIN/FILL IN [A] – [D] buttons on the panel. For example, when the [MAIN A] button is selected in this display and you press the Footswitch, the rhythm section is switched to Main A or Fill In A.

4 INTRO 1 – INTRO 3

These functions correspond to the INTRO [1] – [3] buttons on the panel. For example, when the INTRO [1] button is selected in this display and you press the Footswitch, the rhythm section is switched to Intro 1.

5 ENDING 1 – ENDING 3

These functions correspond to the ENDING [1] – [3] buttons on the panel. For example, when the ENDING [1] button is selected in this display and you press the Footswitch, the rhythm section is switched to Ending 1. After the ending pattern is played, the rhythm stops.

Controlling Glide

You can control the Glide effect by using the Left Footswitch.

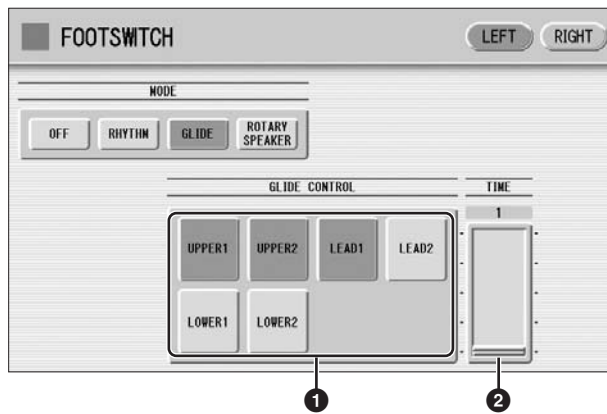

Pressing the Footswitch immediately lowers the pitch of the selected Voice or Voices by a half-step and releasing it slowly returns the pitch to the original.

1 Voice Selections (UPPER1/UPPER2/LEAD1/LEAD2/LOWER1/LOWER2)

Select the desired Voice section(s) to which the Glide function is to be applied.

2 TIME

Determines the speed of the Glide function, or in other words, how gradually the pitch returns when the Footswitch is released. Higher values make the speed slower.

Range: 1 – 5

Controlling Rotary Speaker



Reference Page

Rotary Speaker (page 48)

You can control the Rotary Speaker effect (on/off) by using the Left Footswitch.

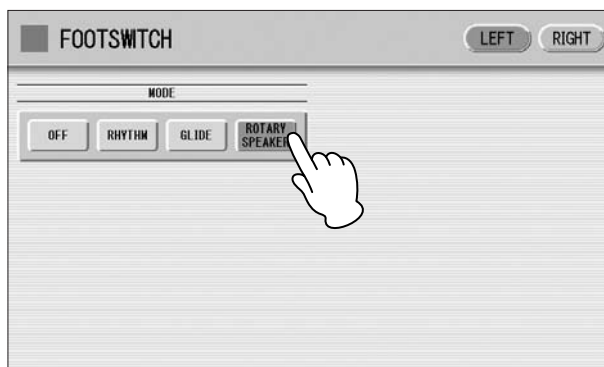

When the [Rotary Speaker] button is selected in this display and you press the Footswitch, the Rotary Speaker effect is switched on or off. This function corresponds to the [ROTARY SP SPEED] button on the panel. To use this function, you'll need to make the appropriate Rotary Speaker settings for each Voice section or Organ Flute Voice. For details, see page 48.

2 Knee Lever

The Knee Lever, located on the underside of the keyboard panel, can be used to turn one of the following on and off: Sustain effect, Melody On Chord function, Lead Slide effect, or Solo function.

Controlling Sustain

You can control on/off status of sustain for the Upper and Lower keyboards by using the Knee Lever. Sustain for the Pedalboard cannot be controlled.



Reference Page

Sustain (page 47)

1 Make sure that the Upper and/or Lower Sustain buttons have been turned on.

2 Fold the Knee Lever down.
Sustain is off when the Knee Lever is folded down.

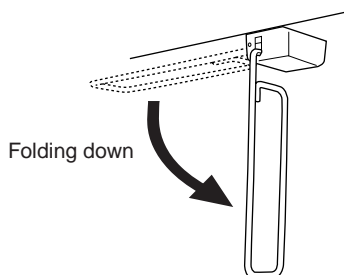
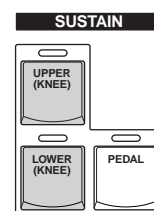

3 To apply sustain, press the Knee Lever to the right.
Sustain is constantly applied as long as the Knee Lever is pressed. Releasing the Knee Lever turns sustain off.

1 When the Knee Lever is folded up:

Sustain is applied constantly, as long as the front panel Sustain buttons are on.

2 When the Knee Lever is vertical:

Sustain is cancelled.

3 When the Knee Lever is continuously pressed to the right:

Sustain is on.

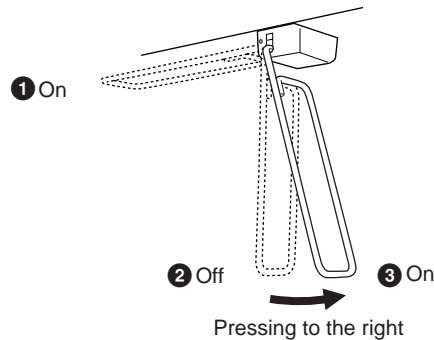

Controlling Melody On Chord

1 Press the [A.B.C./M.O.C.] button on the front panel.
The Melody On Chord section appears in the right half of the display.

2 Set the KNEE control to "ON," and select one of the modes.

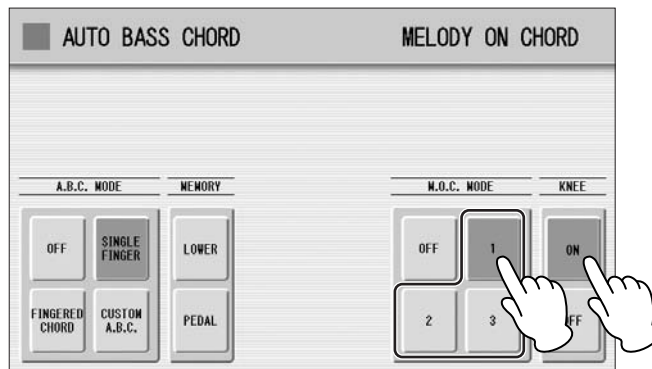
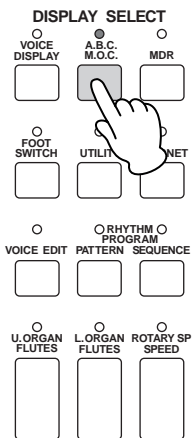

Reference Page

Melody On Chord (page 64)

3 Press the Knee Lever to the right with your knee when you want to apply the M.O.C. effect.

The M.O.C. effect is applied constantly, as long as the Knee Lever is pressed. When you release the Knee Lever, the M.O.C. effect is cancelled.

Controlling Lead Slide



Reference Page

Voice Condition Display
(page 39)

- 1 Call up the Voice Condition display Page 2 of the Lead Voice section to which you want to apply the Lead Slide effect.
- 2 Press the [KNEE] button of the Slide section on the display.

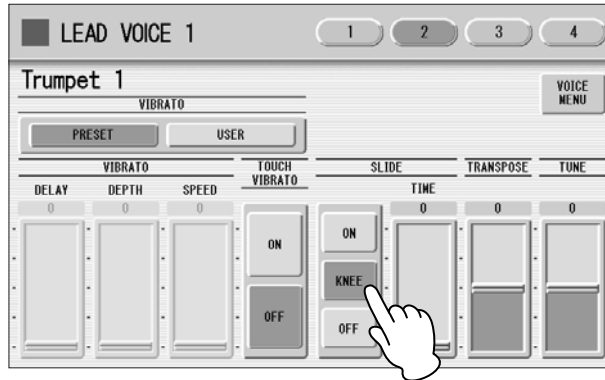

- 3 Press the Knee Lever to the right with your knee when you want to apply the Slide effect.

The Slide effect is applied as long as the Knee Lever is pressed. Releasing the Knee Lever, cancels the Lead Slide effect.

Controlling the Solo Function

You can turn the Solo function on/off by using the Knee Lever. See page 27 for more information.

3 Expression Pedals



Reference Page

Getting Started (page 11)

The Expression pedal can be used to control the volume with your foot as you play. Moreover, the ELS-01C has another Expression Pedal, the 2nd Expression Pedal. The 2nd Expression Pedal can be used to control the Pitch Bend and the Tempo of the Rhythm. The explanation on the 2nd Expression Pedal is given here.

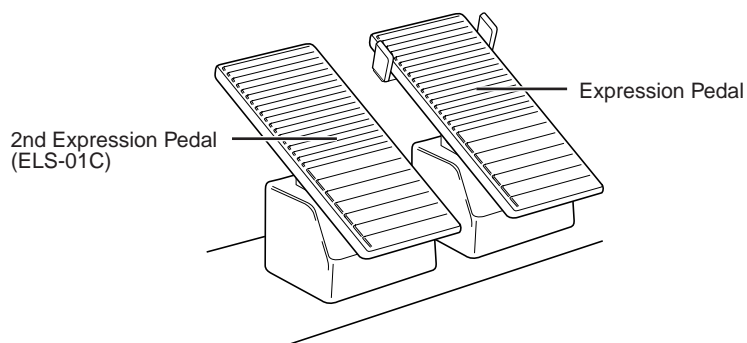

- 1 Press the [UTILITY] button on the front panel.
The Utility display appears.
- 2 Press the [EXP.] button in the upper right of the display to call up the EXP. (Expression) Page.

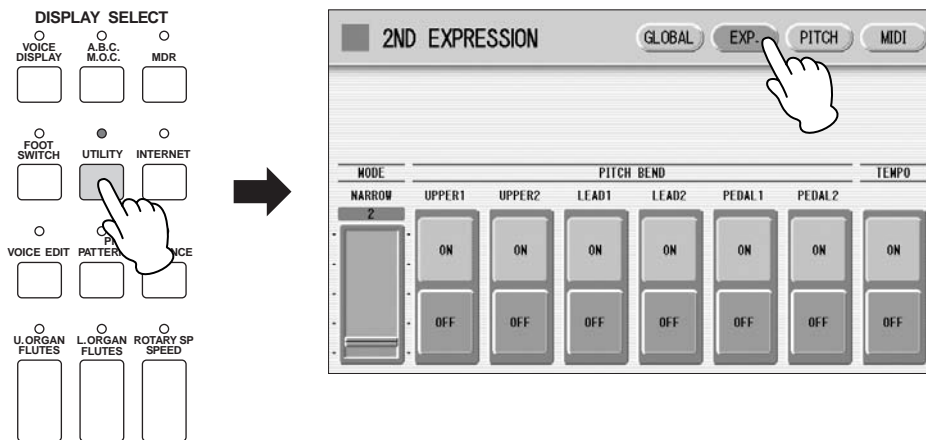

In this display, you can assign the Pitch Bend control or Tempo control to the 2nd Expression Pedal. If both Pitch Bend and Rhythm Tempo controls are set to ON, both functions are applied when you press the 2nd Expression Pedal. Generally one of them is assigned to the 2nd Expression Pedal.

Controlling Pitch Bend

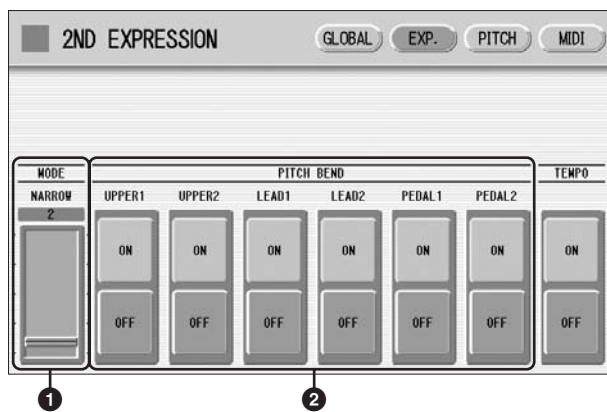

1 MODE

Determines the range of the Pitch Bend control. Each step changes the pitch range by a semitone.

Range: 1 – 12

The setting 2 (NARROW) results in a small amount of pitch variation (over +/- two semitones); the setting 12 (WIDE) results in a large amount of pitch variation (over +/- one octave).

2 Voice Sections (PITCH BEND)

Selects the Voice sections to which the Pitch Bend function will be applied, and turns the function ON. Pitch Bend can be selected independently or together for Upper Voices 1 and 2, Lead Voice 1 and 2, Pedal Voices 1 and 2.

Controlling the Rhythm Tempo

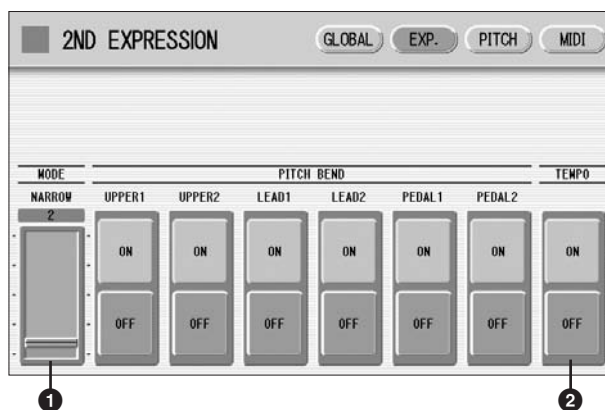

1 MODE

Determines the range of tempo change.

Range: 1 – 12

The setting 2 (NARROW) results in a small amount of tempo change (70% – 140%); the setting 12 (WIDE) results in a large amount of tempo change (50% – 200%).

2 TEMPO

When you want to control the tempo with the 2nd Expression Pedal, set this to “ON.” When set to on, pressing the pedal down with your toe speeds up the tempo and pressing it back with your heel slows it down.

Transpose and Pitch Controls

There are two pitch-related controls on the Electone: Transpose and Pitch. Transpose allows you to change the key of the instrument and Pitch lets you finely adjust the tuning. Transpose and Pitch can be adjusted in the Utility display. (The settings here cannot be recorded to the Music Data Recorder.)

- 1 Press the [UTILITY] button.
The Utility display appears.
- 2 Press the [PITCH] button at the top right of the display to call up the PITCH Page.

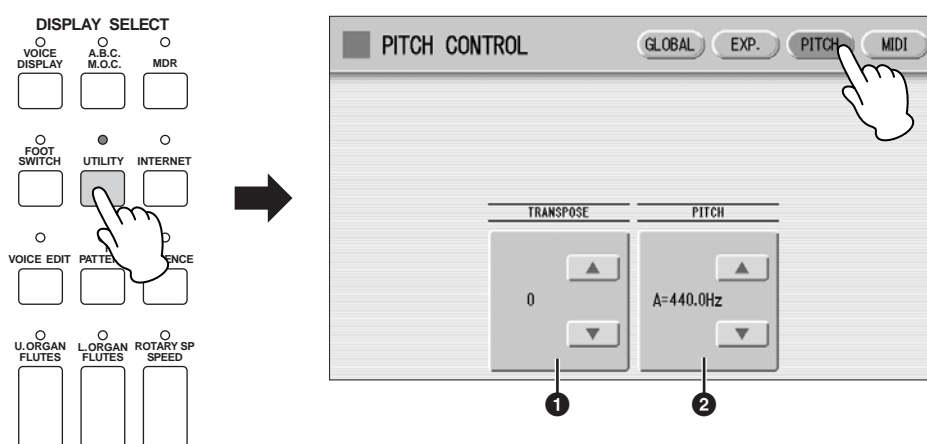

In this display, you can change the Transpose and Pitch settings by using the  buttons on the display or the Data Control Dial.

1 TRANSPOSE

Determines the coarse pitch setting of all the Voices, and is adjustable in half-steps (semitones).

Range: -6 – +6

2 PITCH

Determines the fine pitch setting of all the Voices. Each step changes the pitch by 0.2 Hz. The default Pitch is 440.0 Hz (corresponding to key A3).

Range: 427.2 Hz – 452.6 Hz

You can also change the Transpose and Pitch for each Voice section, in the Voice Condition display. For more information, see page 42.



NOTE

The Transpose/Pitch setting here is not applied to an XG Song.

12 Internet Direct Connection

This convenient, powerful feature lets you directly connect your Electone to the Internet. In this section, you may come across some unfamiliar terms and phrases related to computers and online communications. To look up the meaning of these terms, refer to the Internet Glossary (page 207).

Contents

1 Connecting the Instrument to the Internet	194	3 About the Internet Settings Display	203
2 Accessing the Website from the Electone	195	• Browser	203
• Scrolling the Display	196	• LAN	204
• Following Links	196	• Wireless LAN	204
• Refreshing a Web Page/Canceling Loading of a Web Page	198	• Others	205
• Return to the Previous Web Page	198	4 Exiting from the Internet Display	206
• Saving Bookmarks of Your Favorite Pages	199	5 Initializing Internet Settings	206
• Editing Bookmarks	201	6 Glossary of Internet Terms	207
• Changing the Home Page	202		



NOTE

Depending on the Internet connection, you may not be able to connect to two or more devices (for example, a computer and the instrument), depending on the contract with the provider. This means you cannot connect with the Electone. If in doubt, check your contract or contact your provider.



Reference Page

Connecting USB storage devices or USB-LAN adapter (page 216)

1 Connecting the Instrument to the Internet

You can connect the instrument to a full-time online connection (ADSL, optical fiber, cable Internet, etc.) via a router or a modem equipped with a router.

Use a computer to connect to the Internet and get online before connecting the instrument, since no modem or router settings can be made from the instrument itself.

To use the Internet connection, you will first need to subscribe to an Internet service or provider.

Connection example 1: Connecting by cable (using a modem without router)

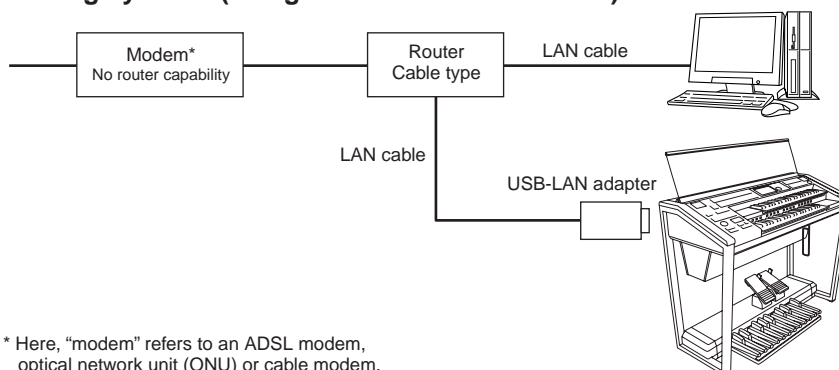

* Here, "modem" refers to an ADSL modem, optical network unit (ONU) or cable modem.

**Connection example 2:
Connecting by cable (using a modem with router)**

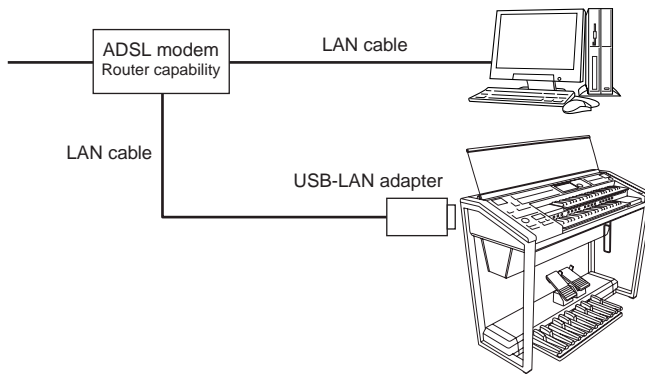

NOTE

Some types of modems require an optional hub network for simultaneously connecting to several devices (such as computer, musical instrument, etc.).

**Connection example 3:
Wireless connection**

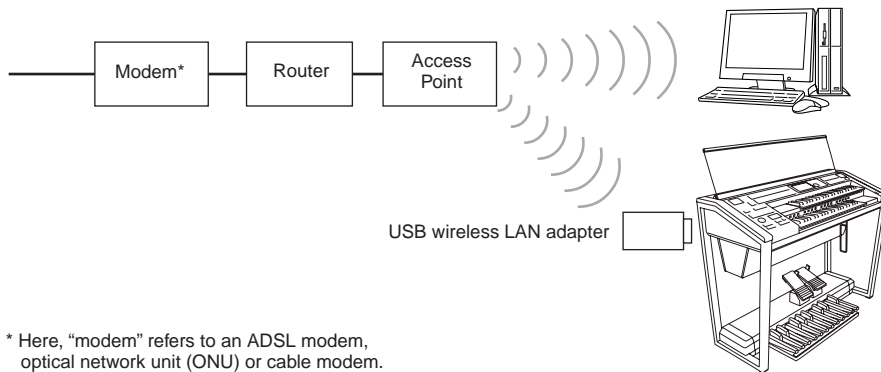

* Here, "modem" refers to an ADSL modem, optical network unit (ONU) or cable modem.

2 Accessing the Website from the Electone

To access the website, press the [INTERNET] button while the instrument is connected to the Internet.

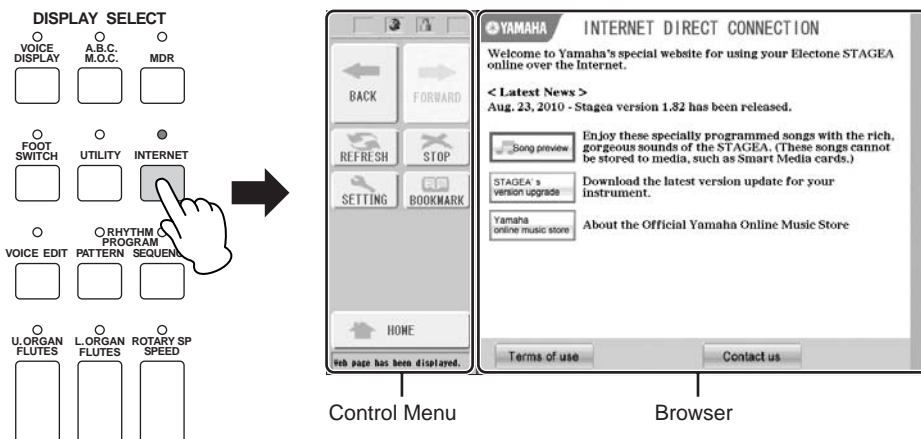

In the Control Menu located in the left part of the display, you can control the displayed website and set various settings. The browser display, to the right of the control menu, is the area in which the website is displayed.



Reference Page

Changing the Home Page
(page 202)

The first page shown when opening a browser and connecting to the Internet is called the “home page.” If you want to return to the home page from another website, press the [HOME] button in the Control Menu.

Scrolling the Display

When the size of the web page is too large to be shown at one time in the browser display of the instrument, a scroll bar appears at the right side or bottom of the display. Touch and move the scroll bar to view those parts of the page that are not shown.

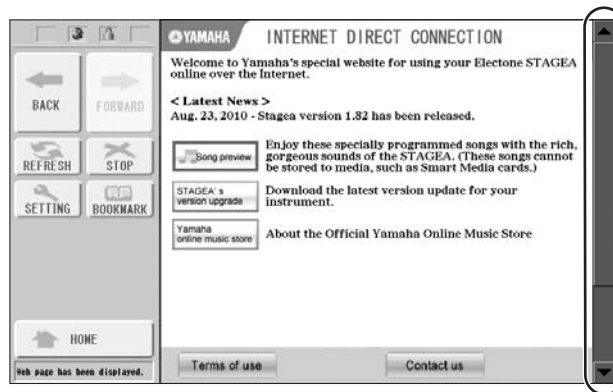

Following Links

When there is a link in the page, it is shown as a button or in colored text, etc. To select the link, press it (the button or text) directly on the display.

The touch panel will not sound when you press a link, even if the touch panel sound is set to ON in the Utility Display (page 16).

Monitoring the Internet Connection Status

The four icons and a message indicate the current Internet connection status.

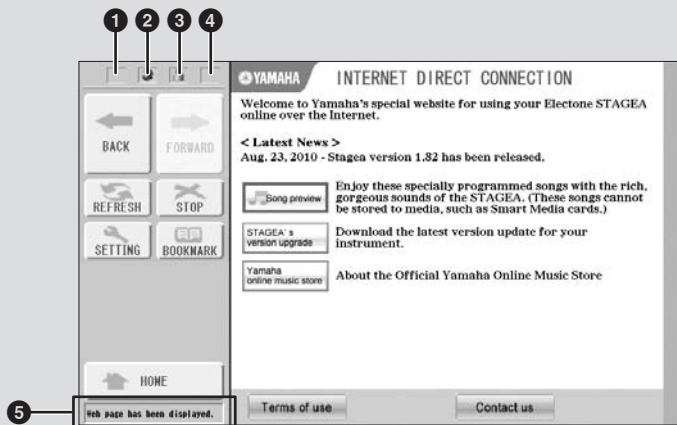

1 Offline indicator (🌐)

This is shown when the instrument is not connected to the Internet. When this appears, you cannot view any web pages.

2 Communication Status indicator (🌐)

This flashes when the web page is being loaded, indicating that communication with the site is in progress. The indicator lights continuously when loading is finished (communication is established).

3 SSL indicator (🔒)

This is shown when the opened website uses SSL, and it indicates that data is encrypted before transmission.

4 Wireless LAN indicator

When you connect the Electone to Internet using wireless LAN, an icon indicating the condition of the connection is displayed. If the signal to the Electone becomes weak or there is no signal from the access point, move the Electone nearer to the access point.

📶: Strong

📶: Normal

📶: Weak (not connected to Internet)

📶: No signal (not connected to Internet)

5 Communication status indicator

The following three messages will be shown depending on the status of accessing web site.

Now opening web page ...	Indicates loading of the web page.
Web page has been displayed.	Indicates the web page has been loaded and the web page is completely displayed.
Disconnected.	Indicates the Electone is offline (not connected to Internet).

Refreshing a Web Page/Canceling Loading of a Web Page



To refresh a web page (to make sure you have the latest version of the page, or to try reloading), press the [REFRESH] button.



To cancel loading of a page (if the page is taking too long to open), press the [STOP] button.

Return to the Previous Web Page



To return to a previously selected web page, press the [BACK] button.



To return to the page selected before pressing the [BACK] button, press the [FORWARD] button.

Saving Bookmarks of Your Favorite Pages

You can “bookmark” the page you’re viewing, and set up a custom link so the page can be instantly called up in the future.

- 1 With the desired page currently selected, press the **[BOOKMARK]** button in the control menu.

The Bookmark display appears, showing a list of the currently saved bookmarks. The title of the web page registered to the selected bookmark is shown below the list.



- 2 Call up the display for registering bookmarks by pressing the **[ADD]** button.

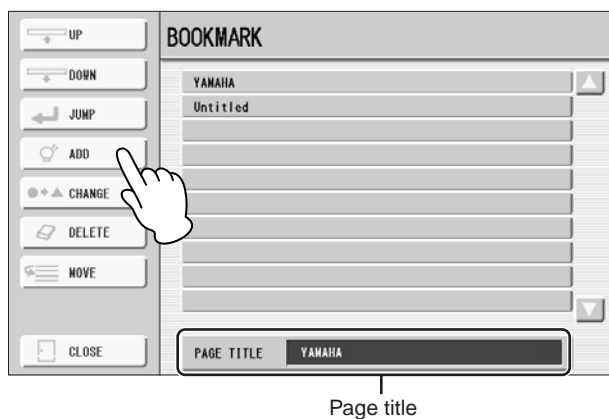

- 3 Select the position of the new bookmark by pressing the desired position directly, or using the [UP]/[DOWN] button or the Data Control Dial.

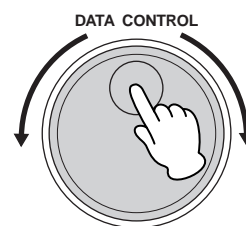
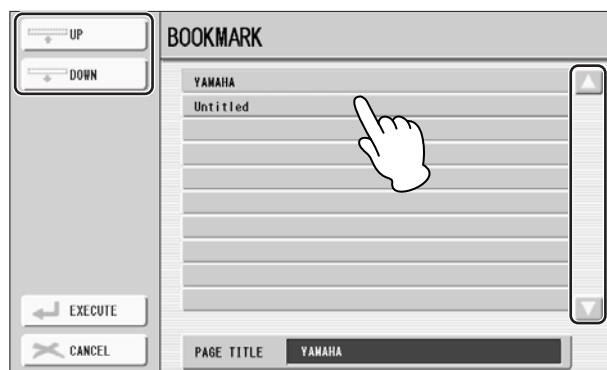

- 4 To save the bookmark, press the [EXECUTE] button, or press the [CANCEL] button to cancel.
- 5 To return to the browser, press the [EXIT] button.

Opening a Bookmarked Page:

- 1 Press the [BOOKMARK] button in the control menu to call up the Bookmark display, then select the desired bookmark.
- 2 Press the [JUMP] button to open the page of the selected bookmark.

Editing Bookmarks

From the Bookmark display, you can change the names and rearrange the order of your bookmarks, as well as delete unnecessary bookmarks from the list.

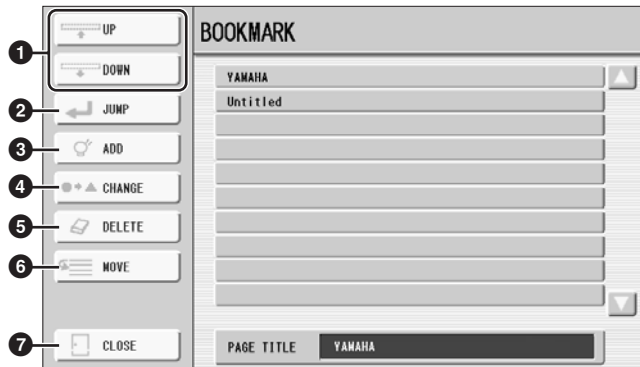

1 UP/DOWN

Moves the selection position in the Bookmark list.

2 JUMP

Opens the web page of the selected bookmark.

3 ADD

Used when saving a bookmark (page 199).

4 CHANGE

Changes the name of the selected bookmark. Pressing this button calls up the display for entering characters. For details on entering characters, see page 108.

5 DELETE

Deletes the selected bookmark from the Bookmark list.

6 MOVE

Changes the order of the bookmarks.

1 Select the bookmark you wish to move, then press the [MOVE] button.

The left part of the display changes, letting you select the new position for the bookmark.

2 Select the intended position by pressing the desired position in the display, or by using the [UP]/[DOWN] buttons or Data Control dial.

3 Move the bookmark to the selected position by pressing the [EXECUTE] button.

7 CLOSE

This closes the Bookmark display and returns to the browser display.

Changing the Home Page

You can specify any desired page on the site to be the home page. In advance, open the page you wish to set as your new home page.

1 Press the [SETTING] button in the control menu to call up the Internet Setting display.

2 Press the [Browser] button to call up the Browser Page.

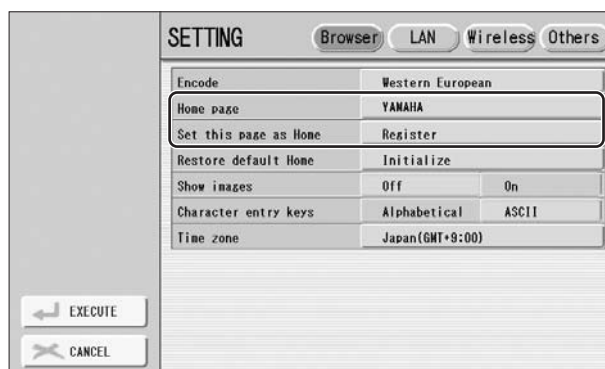

3 Press the [Register] button of the “Set this page as Home.”

4 To return to the browser, press the [EXECUTE] button in the control menu.

A message appears, prompting confirmation of the operation. Select [YES] to return to the browser.

3 About the Internet Settings Display

From the Internet Settings display, you can make various settings related to the Internet connection, including preferences for the menus and displays. The Internet Settings display has four sub-displays: Browser, LAN, Wireless LAN, and Others.

Browser



1 Encode

Selects the character code encoding for the browser.

2 Home page

Shows and allows editing of the web page which is set as the home page.

3 Set this page as Home

For details, refer to “Changing the Home Page” on page 202.

4 Restore default Home

Restores the home page setting.

5 Show images

Image data and pictures in the web page are shown in the browser when this is set to on. Image data is not shown when this is set to off.

6 Character entry keys

This setting lets you select the character order of the virtual keyboard for entering characters. When this is set to “Alphabetical,” the keys are in alphabetical order. When this is set to “ASCII,” the keys are arranged as a conventional “QWERTY” keyboard.

7 Time zone

This determines the time setting for the browser.

LAN

In this display page, you can make settings for the LAN connection. These settings are needed for not only wired LAN connection but also wireless LAN connection.

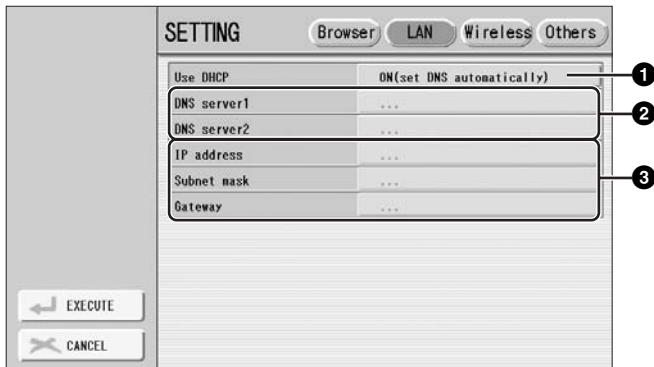

Make a written note of these settings, in case you have to enter the settings again.

Use DHCP	
DNS server 1	
DNS server 2	
IP address	
Subnet mask	
Gateway	

1 Use DHCP

Determines whether or not DHCP is used. If your router is compatible with DHCP, select “ON (set DNS automatically)” here.

2 DNS server 1 / DNS server 2

These determine the addresses of the primary and secondary DNS servers. These settings must be made when “Use DHCP” above is set to “ON (set DNS manually)” or “OFF.”

3 IP address / Subnet mask / Gateway

These settings are available only when DHCP is not used. The settings here are: IP address, subnet mask, and gateway server address. These settings must be made when “Use DHCP” above is set to “OFF.”

Wireless LAN

In this display page, you can make settings for the wireless LAN connection. These settings must be the same as the settings on the Access Point.

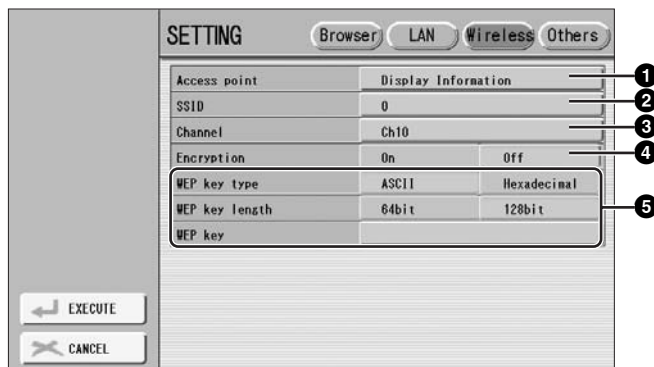

Make a written note of these settings, in case you have to enter the settings again.

SSID		
Channel	Ch	
Encryption	On	Off
WEP key type	ASCII	Hexadecimal
WEP key length	64 bit	128 bit
WEP key		

1 Access Point

Pressing the [Display Information] button calls up the access point list. It shows the access points near the Electone.

Once you select the desired access point and press the [OK] button, a message appears prompting confirmation of whether to transfer the access point settings to the Electone or not. When you select [YES], the SSID, Channel and Encryption settings are transferred to the Electone.

2 SSID

Determines the SSID setting.

3 Channel

Determines the channel.

4 Encryption

Determines whether or not the data is encrypted.

5 WEP key type / WEP key length / WEP key

These settings are available only when Encryption above is enabled. These set the type and length of the encryption key.



NOTE

An access point that is encrypted in a non-WEP format cannot be used.



NOTE

If no signal from the access point is received, the access point cannot be listed.



NOTE

The WEP key type, length and WEP key are not entered automatically. You have to enter them by yourself if you want to use an access point that is encrypted.

Others

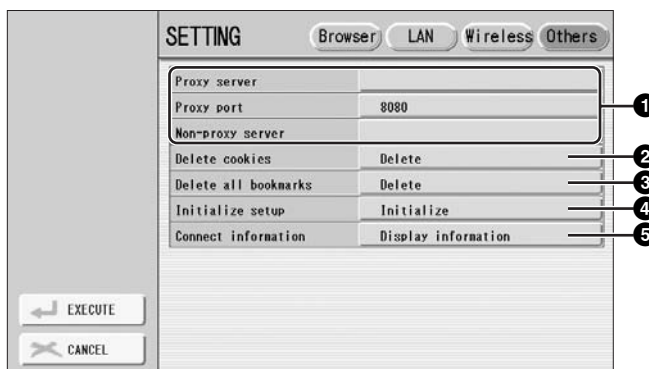

1 Proxy server / Proxy port / Non-proxy server

Determines the proxy server name, port number and the host name for a main, non-proxy server. The settings here are only necessary when using a proxy server.

2 Delete cookies

Deletes the contents of all saved cookies.

3 Delete all bookmarks

Deletes all saved bookmarks.

4 Initialize setup

Restores all settings in the Internet Settings displays to their defaults. See “Initializing Internet Settings” on page 206.

5 Connection information

Shows detailed information on the current connection.



NOTE

When using two or more non-proxy servers, separate each server name with a comma.

4 Exiting from the Internet Display

Pressing any button other than [INTERNET] button quits the Internet Direct Connection and closes the website display. Pressing the [INTERNET] button again automatically opens the previously opened website.

5 Initializing Internet Settings

The settings of the Internet function are not initialized when using the Initialize operation of the Electone (page 21); Internet settings must be initialized separately, as explained here. Initializing will reset to the default values not only the settings of the browser, but also all settings you have made in the Internet Settings displays, including those related to Internet connection.

- 1 Press the [SETTING] button in the control menu to call up the Internet Settings display.
- 2 Press the [Others] button at the top right of the display.
- 3 Press the [Initialize] button to initialize the Internet settings. A message appears, prompting confirmation of the operation.



- 4 Select [YES] to initialize the Internet settings, or select [NO] to abort the operation.

6 Glossary of Internet Terms

Broadband	An Internet connection technology/service (such as ADSL and optical fiber) that allows for high-speed, high-volume data communication.
Browser	The software used to search for, access, and view web pages. For this instrument, this refers to the display that shows the contents of the web pages.
Cookie	A system that records certain information that the user transfers when visiting a website and using the Internet. The function is similar to a preference file in a conventional computer program, in that it “remembers” certain information such as your user name and password, so you don’t have to re-enter the information each time you visit the site.
DHCP	This is a standard or protocol by which IP addresses and other low-level network configuration information can be dynamically and automatically assigned each time connection is made to the Internet.
DNS	A system that translates names of computers connected to a network to their corresponding IP addresses.
Download	Transferring data over a network, from a larger “host” system to a smaller “client” system’s hard drive or other local storage device — much like copying files from your hard disk drive to a floppy disk. For this instrument, this refers to the process of transferring Song and other data from a website to the instrument.
Gateway	A system which links different networks or systems, and makes possible data transfer and conversion despite differing communications standards.
Home page	The first page shown when opening a browser and connecting to the Internet. This phrase is also used to mean the “front screen” or top page of a website.
Internet	A huge network made up of networks, the Internet allows high-speed data transfer among computers, mobile phones and other devices.
IP address	A string of numbers assigned to each computer connected to a network, and indicating the device’s location on the network.
LAN	Short for Local Area Network, this is a data-transfer network that connects a group of computers at a single location (such as an office or home) by means of a special cable.
Link	A highlighted word, button or icon within a web page that, when clicked, opens another web page.
Modem	A device which connects and allows data transfer between a conventional telephone line and a computer. It converts the digital signals from the computer to analog audio for sending over the phone line, and vice versa.
NTP	Short for Network Time Protocol, a standard for setting the internal system clock of the computer over a network. For this instrument, the internal clock of the computer is used to specify the valid time/date for cookies and SSL.
Provider	A communications business that offers Internet connection services. In order to connect to the Internet, it is necessary to contract to a provider.
Proxy	A proxy server is a server that all computers on a local network have to go through before accessing information on the Internet. It intercepts all or designated requests to the real server to see if it can fulfill the requests itself. If not, it forwards the request to the real server. Proxy servers are used to improve performance and speed, and to filter requests, usually for security and to prevent unauthorized access to an internal network.
Router	A device for connecting multiple computer networks. For example, a router is necessary when connecting several computers in a house or office, and allow them to all access the Internet and share data. A router is usually connected between a modem and a computer, although some modems have a built-in router.
Server	A hardware system or computer used as a central point for a network, providing access to files and services.
Site	Short for “website,” this refers to the group of web pages that are opened together. For example, the collection of web pages whose addresses begin with “http://www.yamaha.com/” is referred to as the Yamaha site.
SSID	This is an identification name for specifying a particular network over a wireless LAN connection. Communication is possible only between terminals with matching SSID names.
SSL	Short for Secure Sockets Layer, a standard for transmitting confidential data such as credit card numbers over the Internet.
Subnet mask	A setting used to divide a large-scale network into several smaller networks.
URL	Short for Uniform Resource Locator, a string of characters used to identify and link to specific websites and pages on the Internet. A complete URL usually starts with the characters “http://.”
Web page	Refers to each individual page that makes up a website.
Wireless LAN	A LAN connection that allows data transfer through a wireless, cable-free connection.

13 Connections

On the underside of the Electone keyboard is a separate panel equipped with various input/output terminals and miscellaneous controls.

Contents

1 Accessory Jacks and Controls	208	•Controlling the Electone from an External Device	216
2 Connection Examples – External Devices	211	•Connecting USB storage devices or USB-LAN adapter	216
•Using Headphones	211	3 Connection with Computer	217
•Playing the Sounds of the Electone Through an External Audio System	211	4 MIDI	218
•Recording the Sounds of the Electone to an External Recorder	213	•What is MIDI?	218
•Outputting the Sound of an External Device Through the Built-in Speakers of the Electone	213	•MIDI Messages of the Electone	219
•Connecting a Microphone or Guitar	214	•MIDI Channels	220
•Controlling External MIDI Devices from the Electone	215	5 MIDI Control	221

1 Accessory Jacks and Controls

This section provides brief explanations for each jack/control on the Electone. For details on connecting to external devices, see page 211.

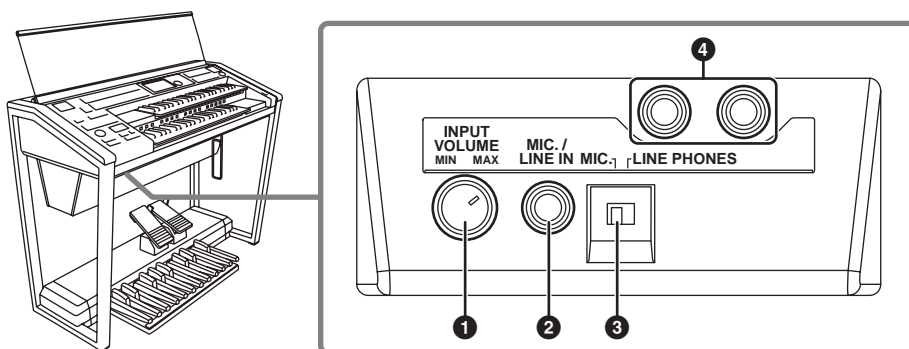

Reference Page

Connecting a Microphone or Guitar (page 214)

1 INPUT VOLUME knob

For adjusting the level of input signal from the MIC./LINE IN jack.

2 MIC./LINE IN jack

For connecting a mono input, such as microphone or guitar. The Electone outputs the microphone or guitar sounds, with reverb processing, through the built-in speaker system.

3 MIC./LINE switch

When connecting a microphone or other electric/electronic instrument to the MIC./LINE IN jack, make sure to set this level gain switch appropriately, depending on the device you use.

4 PHONES jacks

For connection of a stereo headphone set. When headphones are connected to this jack, sound to the Electone's built-in speaker system is automatically cut off, allowing you to play without disturbing others.



Reference Page

Using Headphones (page 211)

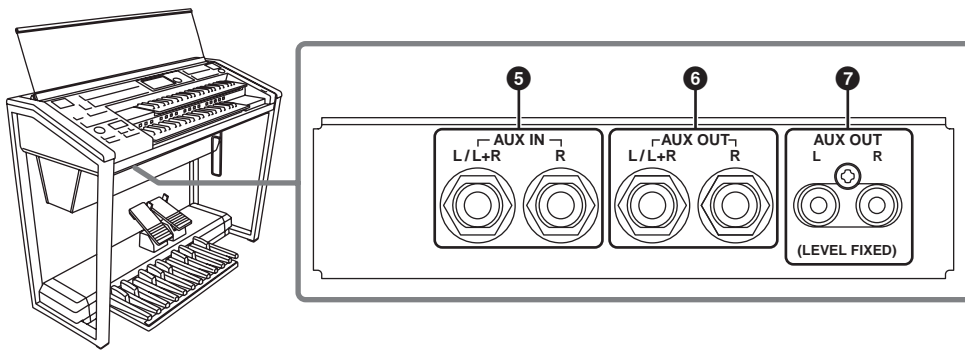

5 AUX IN (Phone; L/L+R, R) jacks

This pair of stereo phone jacks is for connection to an external device. The signal from the connected external device sounds from the Electone's built-in speakers.

6 AUX OUT (Phone; L/L+R, R) jacks

This pair of stereo outputs is for connection to an external amplifier/speaker system. The output level can be controlled with the MASTER VOLUME Dial.

7 AUX OUT (RCA; L, R) jacks (LEVEL FIXED)

This set of stereo outputs is for connection to an external amplifier/speaker. The output level is fixed and cannot be controlled.



Reference Page

Outputting the Sound of an External Device Through the Built-in Speakers of the Electone (page 213)



Reference Pages

Playing the Sounds of the Electone Through an External Audio System (page 211)

Recording the Sounds of the Electone to an External Recorder (page 213)

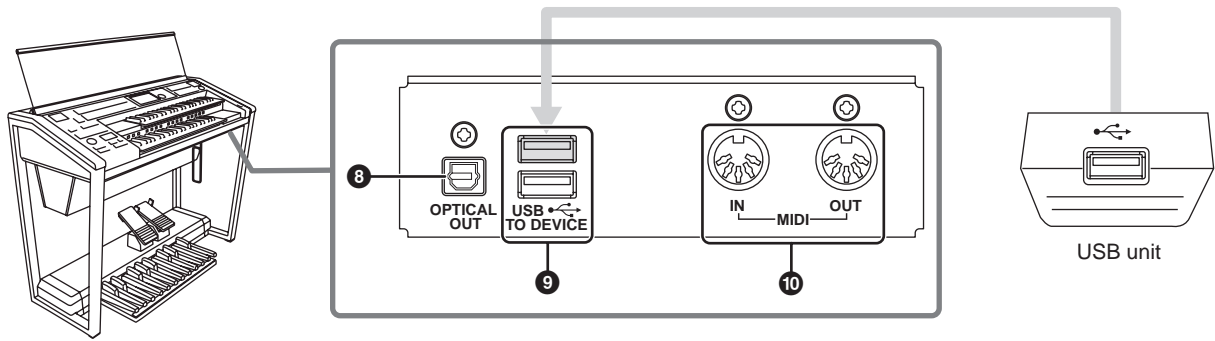

Reference Page

Recording the Sounds of the Electone to an External Recorder (page 213)

8 OPTICAL OUT terminal

For connection using an optical-fiber cable. This terminal outputs a digital signal of 44.1 kHz, 24 bits.



Reference Pages

Precautions when using the USB TO DEVICE terminal (page 100)

Internet Direct Connection (page 194)

Connecting USB storage devices or USB-LAN adapter (page 216)

Installing the Floppy Disk Drive (page 224)

9 USB TO DEVICE terminals

For connecting USB storage devices (such as USB flash memory or floppy disk drive) or a USB-LAN adapter for connecting to the Internet. A USB unit has been installed to one of the terminals for convenient and easy connection/disconnection of a USB device.

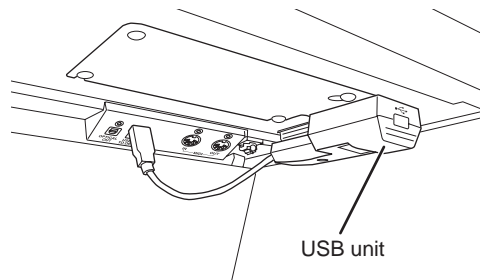

Reference Pages

Controlling External MIDI Devices from the Electone (page 215)

Controlling the Electone from an External Device (page 216)

Connection with Computer (page 217)

What is MIDI? (page 218)

10 MIDI IN/OUT terminals

For connecting external MIDI devices such a synthesizer or sequencer. You can also use these to connect with a computer that has a MIDI Interface.

2 Connection Examples – External Devices



Before connecting the Electone to other electronic components, turn off the power to all the components. Before turning the power of the components on or off, set all volume levels to minimum (0). Otherwise, electrical shock or damage to the components may occur.

Using Headphones

To use headphones, connect them to one of the PHONES jacks (standard 1/4" phone jacks). Two people can enjoy listening to the Electone together by connecting two pairs of headphones to the two jacks.

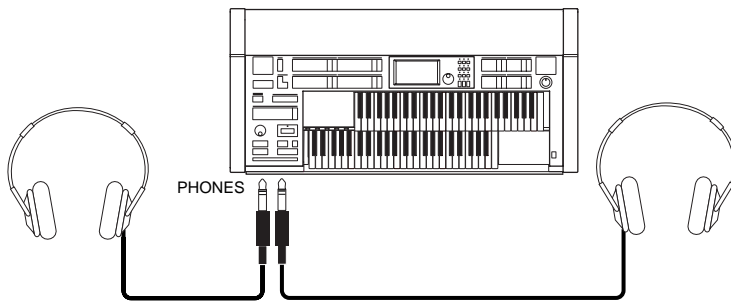

Playing the Sounds of the Electone Through an External Audio System

By using the AUX OUT jacks, you can connect your Electone to external speakers. If you're connecting the Electone to a mono device, use only the AUX OUT L/L+R jack (standard phone).

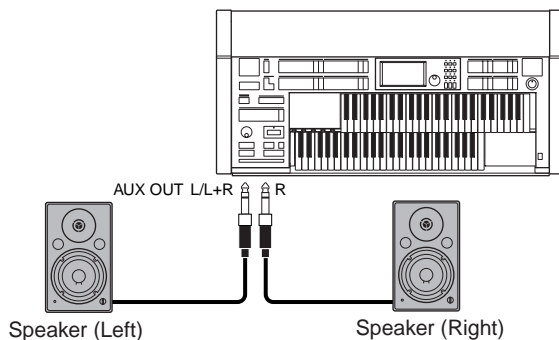

Connection example: Using a mixer for live performance

Generally, when you use the Electone on stage (in concert, etc.), you should connect it to a mixer. By using a mixer, you can easily adjust the volume and tone quality of each component.

To connect to a mixer, use the AUX OUT jacks of the Electone. The Electone features different types of AUX OUT jacks, allowing you to choose the appropriate one for your specific application.

Jacks	Output Type	Location
AUX OUT phone jacks L/L+R, R	Balanced* Level is controlled with the MASTER VOLUME Dial.	Left underside of the keyboard
AUX OUT RCA pin jacks L, R	Unbalanced* LEVEL FIXED	Left underside of the keyboard

*The balanced line is good for long cable runs, or for low-level signals since it picks up less noise than unbalanced lines.

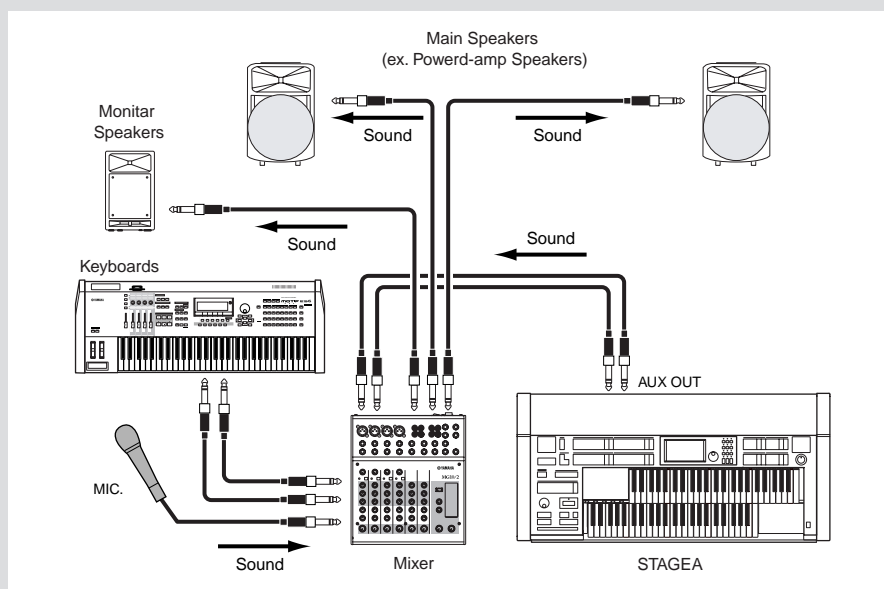

Power-on Procedure

Before turning the power on to all components, set all volume levels to minimum (0) then turn on the power in the following order:

- (1) Electone and external keyboard(s)
- (2) Mixer
- (3) Powered Speaker

To turn the power off, first turn down the volume for each device, then turn off the power in the reverse order (3 → 2 → 1).

Recording the Sounds of the Electone to an External Recorder

You can record your Electone performance to an external recorder, such as an MD recorder or cassette tape recorder, using the OPTICAL OUT terminal or AUX OUT jacks. Using the OPTICAL OUT terminal allows you to record to external media with exceptionally high-quality digital sound (providing the external recorder has an Optical In terminal). Or you can use the AUX OUT jacks (RCA or standard phone, depending on the connectors of your particular recorder).



NOTE

If you want to record the sound input from the AUX IN jack together with the Electone sound, use the AUX OUT standard phone jack on the underside of the keyboard.

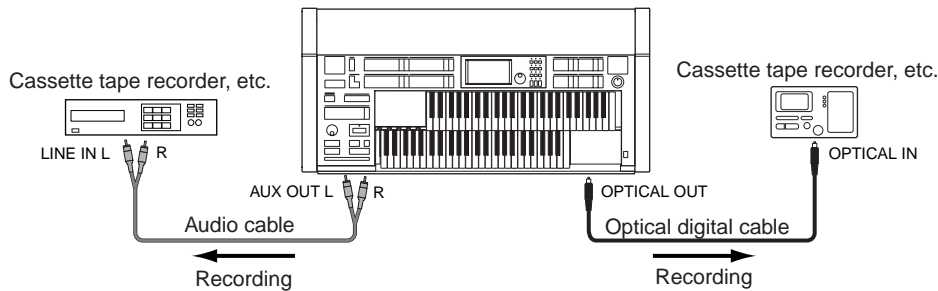

Outputting the Sound of an External Device Through the Built-in Speakers of the Electone

Connect the AUX IN jacks of the Electone with the LINE OUT of an external device, such as a CD player. The sound from the CD player is output from Electone's built-in speakers.

First turn on the power of the external device, then that of the Electone. Reverse this order when you turn the power off.

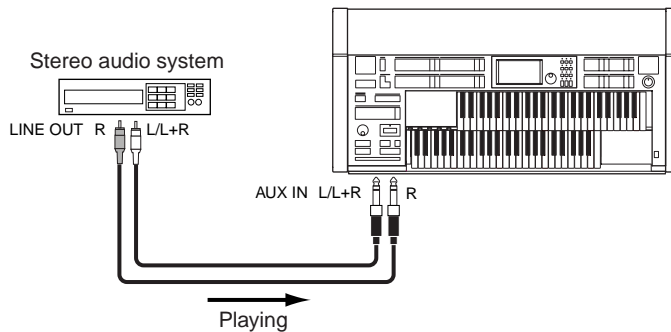

If you're connecting the Electone to a mono device, use only the AUX IN L/L+R jack.

Connecting a Microphone or Guitar

By connecting a microphone to the Electone, you can enjoy singing along with your own performance. The Electone outputs your vocals or guitar sounds through the built-in speakers.

1 Connect your microphone to the MIC./LINE IN jack (standard 1/4" phone jack).

A dynamic microphone is recommended.

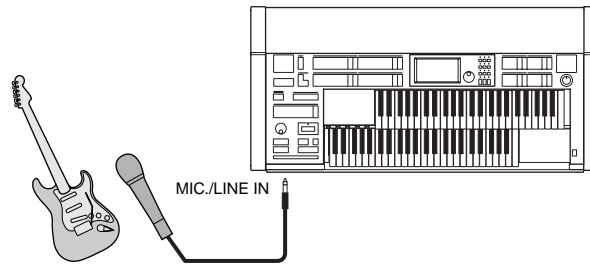

2 Set the MIC./LINE switch to the MIC position when connecting a microphone, or the LINE position when connecting a guitar or other high-level output device.



NOTE

When you're not sure which position is the best, first set it to LINE. If the output level is too low, switch to the MIC position.

MIC. LINE



When connecting a microphone

MIC. LINE

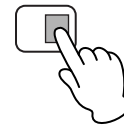

When connecting a guitar

3 Use the INPUT VOLUME knob to set the microphone volume.



To adjust the volume/reverb:

- 1 Press the [UTILITY] button on the panel to call up the Utility display.
- 2 Using the MIC. REVERB and VOLUME sliders in the GLOBAL Page, adjust the amount of the reverb applied to the microphone, and the volume.

 **Reference Page**
Reverb (page 46)

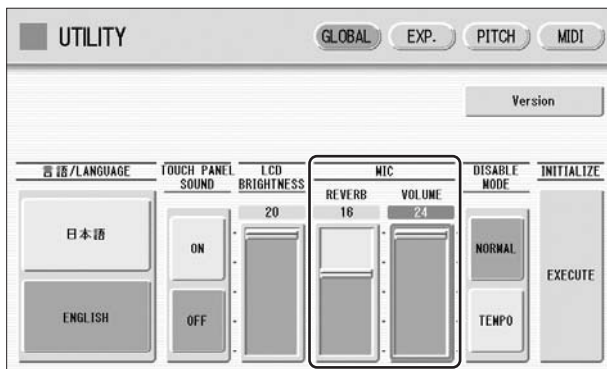

No sound from the microphone can be heard even though you raise the volume here, unless you turn the INPUT VOLUME knob to the right. Similarly, no reverb can be heard even though you raise the reverb level here, unless you raise the total reverb level with the panel REVERB button.

Controlling External MIDI Devices from the Electone

You can use the Electone to remotely play the Voices of a MIDI keyboard (or tone generator), combining them with the Electone and letting you create even richer, more multi-layered sound textures. (The MIDI receive channels of the MIDI keyboard must match the transmit channels on your Electone.)

The Electone transmits as digital data a variety of performance messages along with note information, including values that indicate how far the expression pedal is pressed down and how hard you play the keyboard. How the connected external device responds to these messages depends on the particular device.

 **Reference Page**
What is MIDI? (page 218)

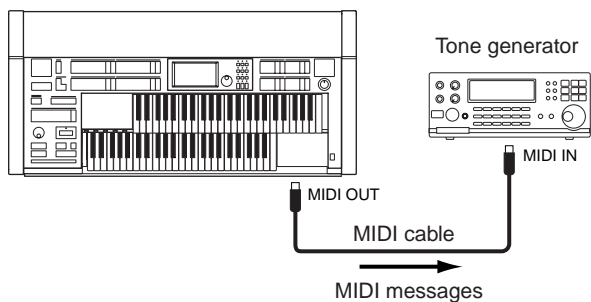

 **NOTE**
When you are using the M.D.R., MIDI data cannot be transmitted.

Controlling the Electone from an External Device



NOTE

When you are using the M.D.R., MIDI data cannot be received.

You can use an external MIDI keyboard or sequencer to remotely play the sounds of your Electone and change its Registrations. (You will need to set the MIDI transmit channels of the MIDI keyboard to match the fixed receive channels on your Electone.)

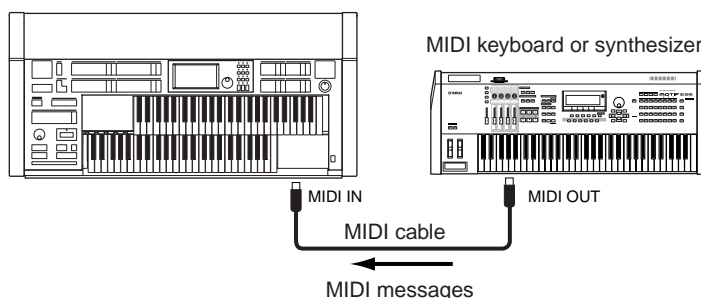

Reference Pages

Installing the Floppy Disk Drive (page 224)

Internet Direct Connection (page 194)

Formatting External Media (page 102)



NOTE

If necessary, use a USB hub. Only self-powered (battery or external power supply) types can be used. Up to two USB hubs can be used.

Connecting USB storage devices or USB-LAN adapter

Using the USB TO DEVICE terminal(s), you can connect USB storage devices (such as the USB flash memory or UD-FD01 floppy disk drive) for saving your Electone data, and/or a USB-LAN adapter for direct connection to the Internet.

When you use USB devices, refer to “Precautions when using the USB TO DEVICE terminal” on page 100.

3 Connection with Computer

By using an optional MIDI interface such as the UX16, you can connect the Electone to the computer, with the MIDI IN/OUT terminals on the instrument. Connect the Electone and the MIDI Interface with two standard MIDI cables (one connecting the OUT terminal on the Electone to the MIDI IN terminal on the interface, and the other connecting the IN terminal on the Electone to the MIDI OUT terminal on the interface). Connect the MIDI interface to the computer with a USB cable.



NOTE

Depending on your particular MIDI interface, you may have to connect the MIDI Interface and the computer with a serial cable.

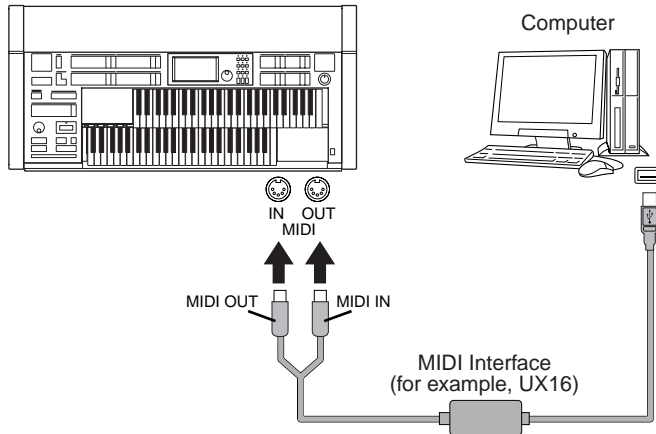

Connecting your Electone to a computer opens up a whole new world of musical possibilities. You can save your original songs to computer and create notation (score writing application or sequencing software is needed), and even upload your original Electone song data to your own website, to promote your talents or share songs with your friends. You can also control the Electone from the computer, for example, by playing a MIDI file on the computer to play back the sounds of your Electone.



NOTE

When you are using the M.D.R., MIDI data cannot be transferred to/from the computer.

4 MIDI

This section explains what MIDI is, and what it can do, as well as how you can use MIDI on your Electone.

What is MIDI?

No doubt you have heard the terms “acoustic instrument” and “digital instrument.” In the world today, these are the two main categories of instruments. Let’s consider a grand piano and a classical guitar as representative acoustic instruments. They are easy to understand. With the piano, you strike a key, and a hammer inside hits some strings and plays a note. With the guitar, you directly pluck a string and the note sounds. But how does a digital instrument go about playing a note?

Acoustic guitar note production

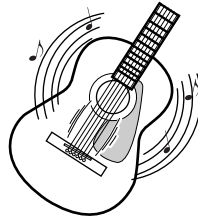

Pluck a string and the body resonates the sound.

Digital instrument note production

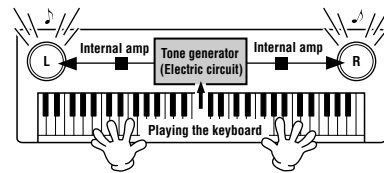

Based on playing information from the keyboard, a sampled note stored in the tone generator is played through the speakers.

As shown in the illustration above, in an electronic instrument the sampled note (previously recorded note) stored in the tone generator section (electronic circuit) is played based on information received from the keyboard, and output through the speakers. So then what is the information from the keyboard that becomes the basis for note production?

For example, let’s say you play a “C” quarter note using the grand piano sound on the Electone keyboard. Unlike an acoustic instrument that puts out a resonated note, the electronic instrument puts out information from the keyboard such as “with what Voice,” “with which key,” “about how strong,” “when was it pressed” and “when was it released.” Then each piece of information is changed into a number value and sent to the tone generator. Using these numbers as a basis, the tone generator plays the stored sampled note.

Example of Keyboard Information

Voice number (with what Voice)	01 (grand piano)
Note number (with which key)	60 (C3)
Note on (when was it pressed)	Timing expressed numerically (quarter note)
Velocity (about how strong)	120 (strong)

As described above, your keyboard performance and panel operations such as Voice selection are handled as MIDI events. All rhythm-related data – including rhythm patterns, auto accompaniment patterns, Rhythm Sequences, etc. – also consist of MIDI messages.

MIDI (Musical Instrument Digital Interface) allows electronic musical instruments to communicate with each other, by sending and receiving compatible Note, Control Change, Program Change and various other types of MIDI data, or messages.

MIDI Messages of the Electone

MIDI messages can be divided into two groups: the Channel Messages and System Messages. Channel Messages consist of data related to the performance on the keyboard for a specific channel. System Messages consist of data that allows several MIDI devices to communicate with each other.

Channel Messages

Each time you play the keyboard on the Electone, channel messages (indicating which keys are played and how strongly) are transmitted via a specific channel. Similarly, the Electone can be played remotely when receiving this data from an external keyboard.

Note On: Indicates which keys are played with the note numbers 0 through 127. The reception note range is C-2 (0) – G8 (127), C3 = 60.

Note Off: Generated when a key is released.

Velocity: Indicates how strongly the key is played. The range is 1 – 127.

For more detailed information, see MIDI Data Format on page 226 and MIDI Implementation Chart on page 236.

- **Program Change**

Program Change messages allow you to change Voices in the middle of a song. With these messages you can change the Registrations of the Electone. For more detailed information, see MIDI Data Format on page 226 and MIDI Implementation Chart on page 236.

- **Control Change**

Control Change Messages let you select Voice banks, control the volume, panning, modulation, portamento time, brightness and various other sound parameters, through specific Control Change numbers.

For more detailed information on the Control Change messages available on the Electone, see MIDI Data Format on page 226 and MIDI Implementation Chart on page 236.

System Messages

- **System Exclusive Messages**

System Exclusive messages are used to exchange the system and Voice/Registration data.

MIDI Channels

MIDI data is assigned to one of sixteen MIDI channels. Using these channels, 1 – 16, the performance data for sixteen different instrument parts can be simultaneously sent over one MIDI cable.

Think of the MIDI channels as TV channels. Each TV station transmits its broadcasts over a specific channel. Your home TV set receives many different programs simultaneously from several TV stations and you select the appropriate channel to watch the desired program.

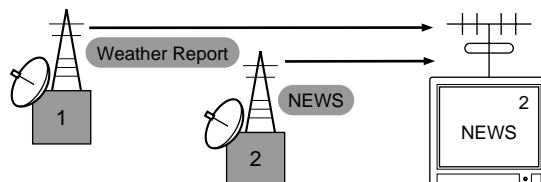

MIDI operates on the same basic principle. The transmitting instrument sends MIDI data on a specific MIDI channel (MIDI Transmit Channel) via a single MIDI cable to the receiving instrument. If the receiving instrument's MIDI channel (MIDI Receive Channel) matches the Transmit Channel, the receiving instrument will sound according to the data sent by the transmitting instrument.

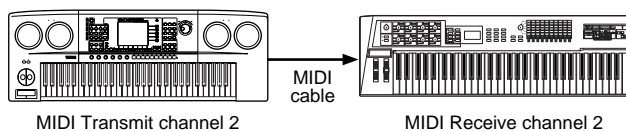

The receive channel of the Electone is fixed at channel 1 for the Upper Keyboard, channel 2 for the Lower Keyboard, and channel 3 for the Pedalboard. This means that when you are using another MIDI device to play the Electone's Voices, you must set the MIDI transmit channel(s) of the connected device to match the receive channel(s) of the Electone. You can select the transmit channel for each keyboard (Upper, Lower and Pedal) from channels 1 – 16. See page 221 for more information.

5 MIDI Control

When you connect your Electone with a second MIDI device (such as a synthesizer or computer), you can determine how the Electone controls that MIDI device, or how the Electone is controlled.

1 Press the [UTILITY] button in the panel to call up the Utility Display.

2 Press the [MIDI] button at the top right of the display to call up the MIDI Page.

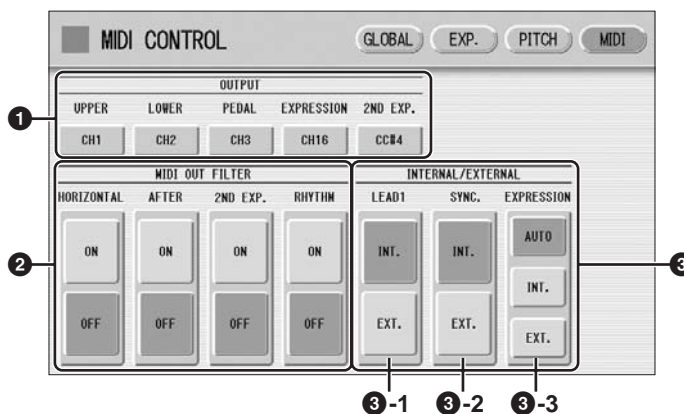

1 OUTPUT

For setting the channels over which MIDI information will be transmitted. Any channel from 1 through 16 can be assigned to each keyboard (the Upper keyboard, the Lower keyboard and the Pedalboard) as well as the Expression pedal and 2nd Expression pedal. The MIDI messages for each keyboard and Expression pedal will be sent on the channels set here. You must set the transmit channel here to match the receive channel of the connected device. (The ELS-01 does not show the 2nd Expression pedal.)

Pressing each OUTPUT button calls up the channel selection pop-up menu. After you select the desired channel, the pop-up menu automatically closes.

The Expression pedal and 2nd Expression pedal can be set to “OFF” (MIDI information will not be transmitted). On the 2nd Expression pedal, CC#4 by which MIDI information is output as Second Expression can be also set.

2 MIDI OUT FILTER

Deletes unnecessary MIDI data and keeps it from being transmitted from the Electone. After Touch and Rhythm start/stop are automatically filtered on the ELS-01.

In addition, Horizontal Touch and Second Expression are automatically filtered on the ELS-01C. Set the parameter for which you wish to disable transmission to ON.



NOTE

If you set Second Expression to on in the MIDI OUT FILTER parameters, the setting in the OUTPUT (1) parameters will be disabled.

3 INTERNAL/EXTERNAL

Switches control over the displayed items between the Electone (INTERNAL) or the connected device (EXTERNAL).

3 - 1 LEAD 1

Determines Internal or External control of the Lead Voices.

INT. (Internal): Lead Voice 1 is played from the Upper keyboard of the Electone. (If the To Lower function is on, it is played from Lower keyboard.)

EXT. (External): The Lead Voice 1 is played from the connected instrument via MIDI channel 4.

3 - 2 SYNC.

To synchronize playback with an external MIDI device, you can use either the instrument's internal clock (INT.) or MIDI clock signals from the external device (EXT.).

INT. (Internal): The instrument uses its own internal clock.

EXT. (External): The instrument uses MIDI clock signals from the external device (MIDI).

3 - 3 EXPRESSION

Determines the control of the expression pedal functions. Ordinarily, this control is set to AUTO.

AUTO: Internal and External is automatically switched.

INT. (Internal): You can manually control the expression pedal even during M.D.R. playback.

EXT. (External): While playing the M.D.R. or receiving MIDI messages, the expression pedal is invalid. (The volume is controlled by the recorded data in a USB flash memory or received MIDI data.)

14 Appendix

Bench Assembly

Have a Phillips-head (+) screwdriver ready.

Bench for the ELS-01

- 1 Turn the bench board over and install two legs for the front side.

Tighten the bolts using the included wrench (as shown).

 Make sure to put washers between the bolts and the bench board.

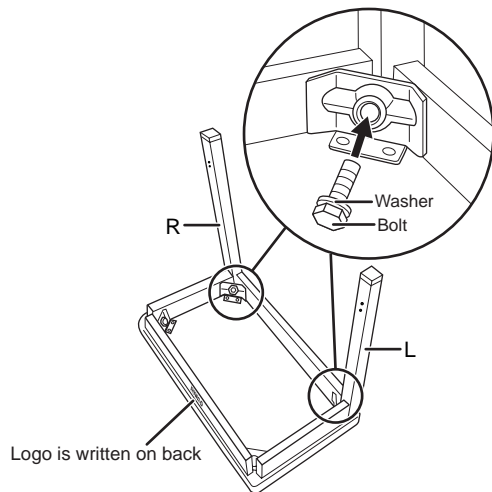

- 2 Install the foot rest to the legs with the included four screws, using a screwdriver.

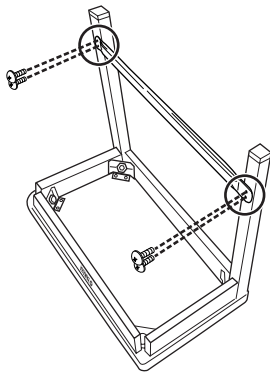

- 3 Install the two legs for the back side.

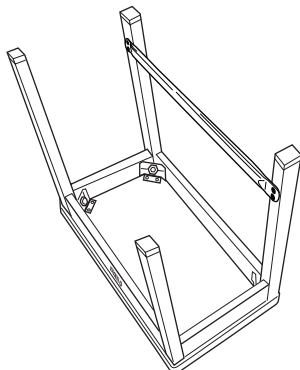

Bench for the ELS-01C

- 1 Turn the bench board over and install the legs with the included eight screws.

Tighten the screws using the included hexagonal wrench (as shown).

 Make sure to put washers between the screws and the bench board.

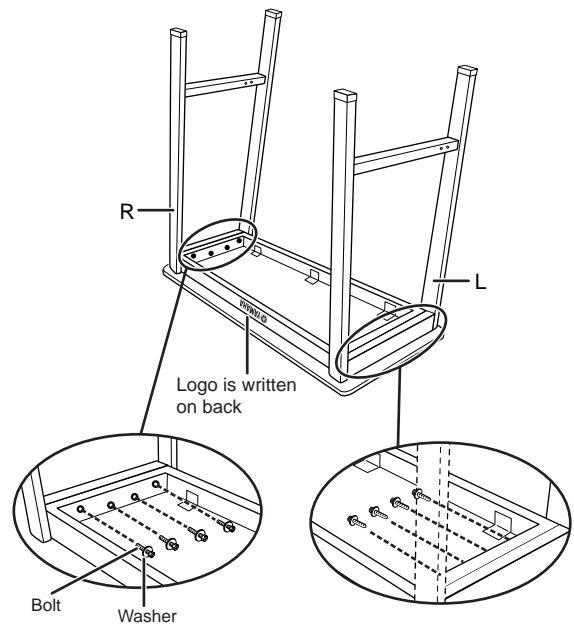

- 2 Install the foot rest to the legs with the included four screws, using a screwdriver.

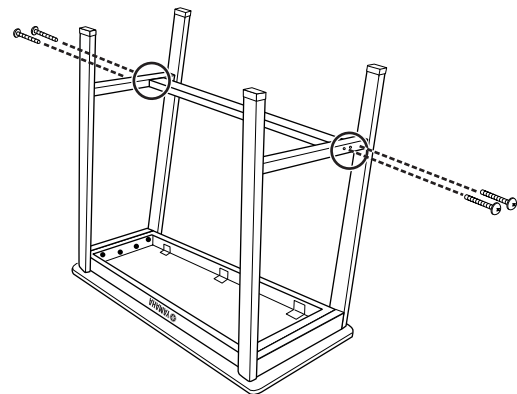

If the bench screws become loose due to extensive long-term use, tighten them periodically using the included tool and a screwdriver.

Installing Optional Hardware

Installing the Floppy Disk Drive

The optional UD-FD01 floppy disk drive can be installed to the bottom of the instrument by using the included floppy disk drive case. Have a Phillips-head (+) screwdriver ready.

! Make sure that the screwdriver head snugly fits the slots of the screw head. In particular, avoid applying excessive force with an ill-fitting screw driver; doing so may strip the slots and damage the screws.

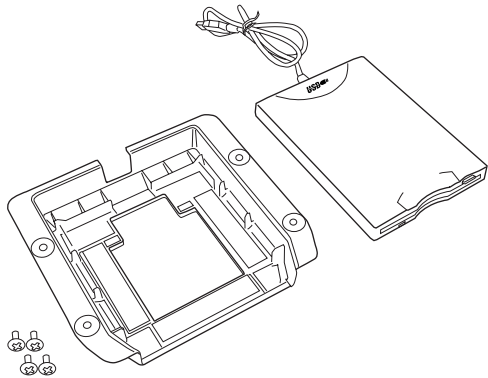

NOTE

None of the included screws are necessary for installing the UD-FD01 to this Electone.

1 Remove the three backing papers from the adhesive tape in the case, and fit the floppy disk drive into the case.

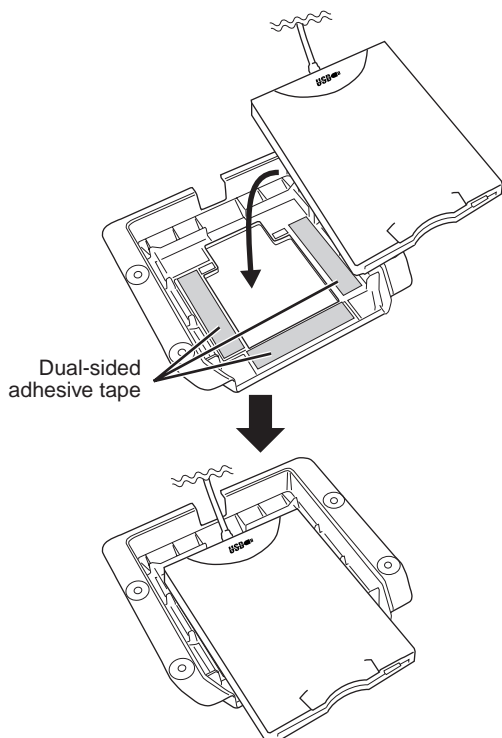

2 Fold the USB cable inside the case as shown.

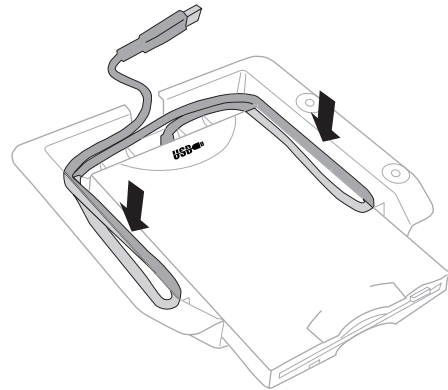

3 Remove the USB unit from the Electone by disconnecting the USB cable and removing the four screws.

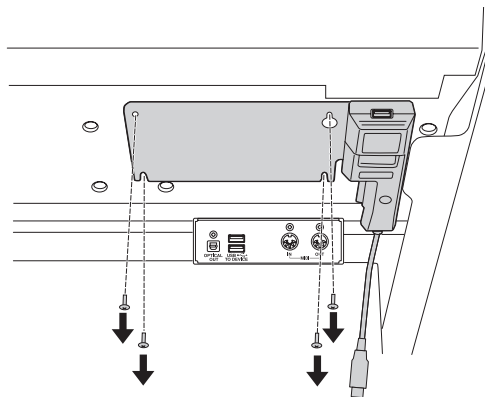

4 Put the USB unit on top of the UD-FD01 floppy disk drive as shown.

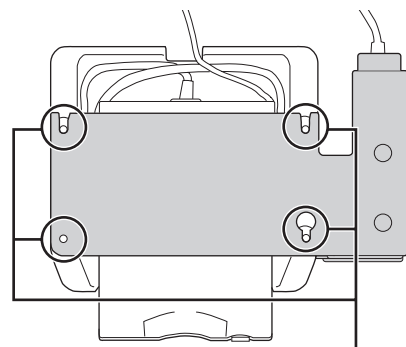

Align the four holes of these two units.

5 Install these two units together with the screws removed in step 3.

First temporarily install the right-front screw, then insert and partially fix the remaining three screws. Finally, firmly tighten all four screws.

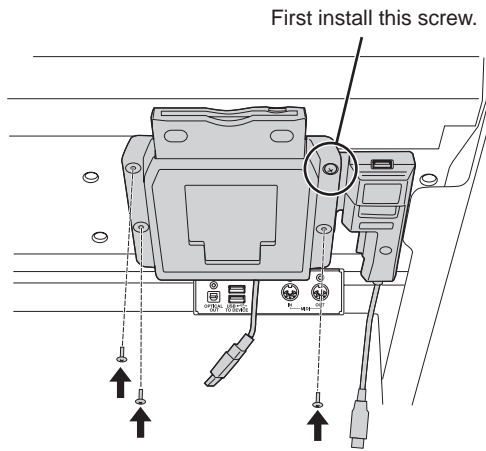

6 Connect the USB cables for both units to the USB TO DEVICE terminals.

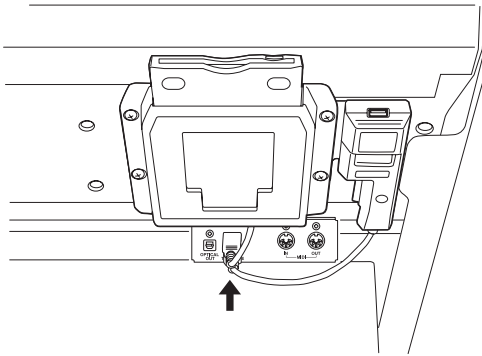

MIDI Data Format

1. Channel Messages

1.1 EL Mode

“X” indicates “Not available.”
“O” indicates “Available.”

Code (Hexadecimal)	Function	Receive	Transmit	Remarks
8n, nn, 00-7F	Note Off	1ch 2ch 3ch (4ch)* 5-14ch 15ch	X X X X X X	UK LK PEDAL LEAD 1 XG Keyboard Percussion
9n, nn, 00 9n, nn, 01-7F	Note Off Note On	1ch 2ch 3ch (4ch)* 5-14ch 15ch	(1ch)* (2ch)* (3ch)* X X X	UK LK PEDAL LEAD 1 XG Keyboard Percussion
An, nn, 00-7F	Polyphonic After Touch	5-14ch	X	XG
Bn, 00, 00-7F Bn, 20, 00-7F	Bank select	5-14ch	X	XG
Bn, 01, 00-7F	Modulation	5-14ch	X	XG
Bn, 04, 00-7F	2nd Expression	16ch (4ch)*	16ch (4ch)**	Control LEAD 1 (ELS-01 not transmitted)
Bn, 05, 00-7F	Portamento Time	5-14ch	X	XG
Bn, 06, 00-7F Bn, 26, 00-7F	Data Entry	5-14ch	X	XG
Bn, 07, 00-7F	Volume	5-14ch	X	XG
Bn, 0A, 00-7F	Pan	5-14ch	X	XG
Bn, 0B, 00-7F	Expression	16ch 5-14ch	(16ch)*	Control XG
Bn, 10, 00-7F	VA After Touch	1ch	(1ch)*	UK (ELS-01C only)
Bn, 40, 00-7F	Hold	5-14ch	X	XG
Bn, 41, 00-7F	Portamento	5-14ch	X	XG
Bn, 42, 00-7F	Sostenuto	5-14ch	X	XG
Bn, 43, 00-7F	Soft Pedal	5-14ch	X	XG
Bn, 47, 00-7F	Resonance	5-14ch	X	XG
Bn, 48, 00-7F	Release Time	5-14ch	X	XG
Bn, 49, 00-7F	Attack Time	5-14ch	X	XG
Bn, 4A, 00-7F	Brightness	5-14ch	X	XG
Bn, 4B, 00-7F	Decay Time	5-14ch	X	XG
Bn, 4C, 00-7F	Vibrato Rate	5-14ch	X	XG
Bn, 4D, 00-7F	Vibrato Depth	5-14ch	X	XG
Bn, 4E, 00-7F	Vibrato Delay	5-14ch	X	XG
Bn, 54, 00-7F	Portamento Control	5-14ch	X	XG
Bn, 5B, 00-7F	Reverb Send Level	5-14ch	X	XG
Bn, 5D, 00-7F	Chorus Send Level	5-14ch	X	XG
Bn, 5E, 00-7F	Variation Effect Send Level	5-14ch	X	XG
Bn, 60, 00-7F Bn, 61, 00-7F	Data Increment Data Decrement	5-14ch	X	XG
Bn, 62, 00-7F Bn, 63, 00-7F	NRPN LSB NRPN MSB	5-14ch	X	XG
Bn, 64, 00-7F Bn, 65, 00-7F	RPN LSB RPN MSB	5-14ch	X	XG

Code (Hexadecimal)	Function	Receive	Transmit	Remarks
Bn, 78, 00 Bn, 79, 00 Bn, 7B, 00 Bn, 7C, 00 Bn, 7D, 00 Bn, 7E, 00 Bn, 7F, 00	All Sound Off Reset All Controllers All Note Off Omni Off Omni On Mono Poly	5-14ch	×	XG
Cn, nn	Program Change	5-14ch 16ch	×	XG Control
Dn, 00-7F	After Touch	1ch 2ch 3ch (4ch)* 5-14ch	(1ch)* (2ch)* (3ch)*	UK LK PEDAL LEAD 1 XG
En, 00-7F, 00-7F	Pitch Bend	1ch 2ch (4ch)* ×	(1ch)* (2ch)* ×	UK LK LEAD 1 2nd Expression (ELS-01C only) XG
		×	(1-16ch)*	
		5-14ch		

* Can be changed in the MIDI settings (page 221).

** Can be output when assigned to channel 4.

1.2 XG Mode

Code (Hexadecimal)	Function	Receive	Transmit	Remarks
8n, nn, 00-7F	Note Off	1-16ch	×	
9n, nn, 00 9n, nn, 01-7F	Note On Note Off	 1-16ch	(1ch)* (2ch)* (3ch)*	UK LK PEDAL
An, nn, 00-7F	Polyphonic After Touch	1-16ch	×	
Bn, 00, 00-7F Bn, 20, 00-7F	Bank select	1-16ch	×	
Bn, 01, 00-7F	Modulation	 1-16ch	×	
Bn, 04, 00-7F	2nd Expression	×	16ch (4ch)**	Control LEAD 1 (ELS-01C only)
Bn, 05, 00-7F	Portamento Time	1-16ch	×	
Bn, 06, 00-7F Bn, 26, 00-7F	Data Entry	1-16ch	×	
Bn, 07, 00-7F	Volume	1-16ch	×	
Bn, 0A, 00-7F	Pan	1-16ch	×	
Bn, 0B, 00-7F	Expression	 1-16ch	(16ch)*	Control
Bn, 10, 00-7F	VA After Touch	×	(1ch)*	UK (ELS-01C only)
Bn, 40, 00-7F	Hold	1-16ch	×	
Bn, 41, 00-7F	Portamento	1-16ch	×	
Bn, 42, 00-7F	Sostenuto	1-16ch	×	
Bn, 43, 00-7F	Soft Pedal	1-16ch	×	
Bn, 47, 00-7F	Resonance	1-16ch	×	
Bn, 48, 00-7F	Release Time	1-16ch	×	
Bn, 49, 00-7F	Attack Time	1-16ch	×	
Bn, 4A, 00-7F	Brightness	1-16ch	×	
Bn, 4B, 00-7F	Decay Time	1-16ch	×	
Bn, 4C, 00-7F	Vibrato Rate	1-16ch	×	

Code (Hexadecimal)	Function	Receive	Transmit	Remarks
Bn, 4D, 00-7F	Vibrato Depth	1-16ch	×	
Bn, 4E, 00-7F	Vibrato Delay	1-16ch	×	
Bn, 54, 00-7F	Portamento Control	1-16ch	×	
Bn, 5B, 00-7F	Reverb Send Level	1-16ch	×	
Bn, 5D, 00-7F	Chorus Send Level	1-16ch	×	
Bn, 5E, 00-7F	Variation Effect Send Level	1-16ch	×	
Bn, 60, 00-7F Bn, 61, 00-7F	Data Increment Data Decrement	1-16ch	×	
Bn, 62, 00-7F Bn, 63, 00-7F	NRPN LSB NRPN MSB	1-16ch	×	
Bn, 64, 00-7F Bn, 65, 00-7F	RPN LSB RPN MSB	1-16ch	×	
Bn, 78, 00 Bn, 79, 00 Bn, 7B, 00 Bn, 7C, 00 Bn, 7D, 00 Bn, 7E, 00 Bn, 7F, 00	All Sound Off Reset All Controllers All Note Off Omni Off Omni On Mono Poly	1-16ch	×	
Cn, 00-7F	Program Change	1-16ch	16ch	Control
Dn, 00-7F	After Touch	1-16ch	(1ch)* (2ch)* (3ch)*	UK LK PEDAL
En, 00-7F, 00-7F	Pitch Bend	1-16ch	(1ch)* (2ch)* (1-16ch)* ×	UK LK 2nd Expression (ELS-01C only)

* Can be changed in the MIDI settings (page 221).

** Can be output when assigned to channel 4.

2. Realtime Messages

Code (Hexadecimal)	Function	Receive	Transmit	Remarks
F8	Clock	○*	○	
FA	Start	○	○	
FC	Stop	○	○	
FE	Active Sensing	○	○	
FF	Reset	×	×	

* Received only when in the Ext. mode

3. System Exclusive Messages

3.1 Format

Universal Realtime Messages

Code (Hexadecimal)	Message	Receive	Transmit
F0, 7F, 7F, 04, 01, SS, TT, F7 XN	GM2 Master Volume	○	×
F0, 7F, 7F, 04, 03, SS, TT, F7 XN	GM2 Master Fine Tuning	○	×
F0, 7F, 7F, 04, 04, 00, TT, F7 XN	GM2 Master Coarse Tuning	○	×
F0, 7F, 7F, 04, 05, 01, 01, 01, 01, PP, VV, ..., F7 XN	GM2 Reverb Parameter	○	×

Code (Hexadecimal)	Message	Receive	Transmit
F0, 7F, 7F, 04, 05, 01, 01, 01, 01, 02, PP, VV, ..., F7 XN	GM2 Chorus Parameter	○	×
F0, 7F, 7F, 09, 01, 0n, PP, VV, ..., F7 XN	GM2 After Touch Parameter	○	×
F0, 7F, 7F, 09, 03, 0n, CC, PP, VV, ..., F7 XN	GM2 Control Change Parameter	○	×
F0, 7F, 7F, 0A, 01, 0n, KK, CC, PP, VV, ..., F7 XN	GM2 Key-Based Controller	○	×

Universal Non-Realtime Messages

Code (Hexadecimal)	Message	Receive	Transmit
F0, 7E, 7F, 09, 01, F7 XN	GM ON	○	×
F0, 7E, 7F, 09, 03, F7 XN	GM2 ON	○	×
F0, 7E, 7F, 09, 02, F7 XN	GM OFF	○	×
F0, 7E, 7F, 08, 08, JJ, GG, MM, ..data..., F7 XN	GM2 Scale/Octave Tuning	○	×

XG Native

Code (Hexadecimal)	Message	Receive	Transmit
F0, 43, 1N, 4C, AH, AM, AL, ..data..., F7	XG Parameter Change	○	×
F0, 43, 0N, 4C, BH, BL, AH, AM, AL, ..data..., cc, F7	XG Bulk Dump	○	×
F0, 43, 1N, 27, 30, 00, 00, MM, LL, cc, F7	XG Master Tuning	○	×

Clavinova Exclusive

Code (Hexadecimal)	Message	Receive	Transmit
F0, 43, 73, 01, 02, F7 03	Request for Internal Synch. Mode	○	×
	Request for External Synch. Mode	○	×

Message Exclusive

Code (Hexadecimal)	Message	Receive	Transmit
F0, 43, 60, 7A, F7	Rhythm Start	○	×
F0, 43, 60, 7D, F7	Rhythm Stop	○	×

Electone Exclusive

Code (Hexadecimal)	Message	Receive	Transmit
F0, 43, 70, ID, 00, F7	Model ID Data	×	○
F0, 43, 70, 70, 30, F7	Request-to-Send Model ID Data	○	×
F0, 43, 70, 70, 40, nn(*1), 7F, F7 00	Switch ON	○	○
	Switch OFF	○	○
F0, 43, 70, 70, 40, 50, TL, TH, F7	Tempo	○	○
F0, 43, 70, 78, 41, cc, dd, F7(*2)	Panel Switch Events	○	○
F0, 43, 70, 78, 42, 3C, ..data..., F7	Current Registration Data	○	○
F0, 43, 70, 78, 44, ..data..(*3), F7	MIDI Parameters	○	○
F0, 43, 70, 70, 70, nn(*4), F7	MDR	○	×
F0, 43, 70, 70, 73, F7	EL ON	○	×
F0, 43, 70, 70, 78, 00, 00, F7	Bar Signal	×	○

X: don't care N: Device Number ("0" on ELS-01/01C) ID: Model ID (ELS-01C=4DH, ELS-01=4EH)

*1. Switches

nn	Switch	Receive	Transmit
45H	Left Footswitch	○	○
47H	Knee Lever	○	○

*2. Panel Switch Events

MIDI Exclusive Format
F0, 43, 70, 78, 41, cc, dd, F7

Selectors

cc	Switch	dd				Remarks
		Receive	Rx Range	Transmit	Tx Range	
0F	Registration Memory [1-16]	○	[00-0F]	×	-	

Volume

cc	Switch	dd				Remarks
		Receive	Rx Range	Transmit	Tx Range	
12	Upper Keyboard Voice 1 Volume	○	[00-7F]	○	[00-7F]	Volume Data 00:MAX, 7F:MIN
13	Lower Keyboard Voice 1 Volume	○	[00-7F]	○	[00-7F]	Volume Data 00:MAX, 7F:MIN
14	Upper Keyboard Voice 2 Volume	○	[00-7F]	○	[00-7F]	Volume Data 00:MAX, 7F:MIN
15	Lower Keyboard Voice 2 Volume	○	[00-7F]	○	[00-7F]	Volume Data 00:MAX, 7F:MIN
16	Lead Voice 1 Volume	○	[00-7F]	○	[00-7F]	Volume Data 00:MAX, 7F:MIN
17	Pedal Voice 1 Volume	○	[00-7F]	○	[00-7F]	Volume Data 00:MAX, 7F:MIN
18	Pedal Voice 2 Volume	○	[00-7F]	○	[00-7F]	Volume Data 00:MAX, 7F:MIN
19	Lead Voice 2 Volume	○	[00-7F]	○	[00-7F]	Volume Data 00:MAX, 7F:MIN
1A	Percussion Volume	○	[00-7F]	○	[00-7F]	Volume Data 00:MAX, 7F:MIN
1B	Reverb Depth	○	[00-7F]	○	[00-7F]	Depth Data 00:MAX, 7F:MIN

Organ Flute Voice

cc	Switch	dd				Remarks
		Receive	Rx Range	Transmit	Tx Range	
30	Upper Organ Flute Voice [U. ORGAN FLUTES]	○	[00-01]	○	[00-01]	00:OFF, 01:ON
31	Lower Organ Flute Voice [L. ORGAN FLUTES]	○	[00-01]	○	[00-01]	00:OFF, 01:ON

To Lower

cc	Switch	dd				Remarks
		Receive	Rx Range	Transmit	Tx Range	
36	Lead Voice 1 To Lower [TO LOWER ▼]	○	[00-01]	○	[00-01]	00:OFF, 01:ON
37	Pedal Voice 1 To Lower [TO LOWER ▲]	○	[00-01]	○	[00-01]	00:OFF, 01:ON
38	Pedal Voice 2 To Lower [TO LOWER ▲]	○	[00-01]	○	[00-01]	00:OFF, 01:ON

Solo Mode

cc	Switch	dd				Remarks
		Receive	Rx Range	Transmit	Tx Range	
39	Lead Voice 2 Solo (Knee) [SOLO (KNEE)]	○	[00-01]	○	[00-01]	00:OFF, 01:ON

Brilliance

cc	Switch	dd				Remarks
		Receive	Rx Range	Transmit	Tx Range	
42	Upper Keyboard Voice 1 Brilliance	○	[00-06]	○	[00-06]	00:BRILLIANT, 06:MELLOW
43	Lower Keyboard Voice 1 Brilliance	○	[00-06]	○	[00-06]	00:BRILLIANT, 06:MELLOW
44	Upper Keyboard Voice 2 Brilliance	○	[00-06]	○	[00-06]	00:BRILLIANT, 06:MELLOW
45	Lower Keyboard Voice 2 Brilliance	○	[00-06]	○	[00-06]	00:BRILLIANT, 06:MELLOW
46	Lead Voice 1 Brilliance	○	[00-06]	○	[00-06]	00:BRILLIANT, 06:MELLOW
47	Pedal Voice 1 Brilliance	○	[00-06]	○	[00-06]	00:BRILLIANT, 06:MELLOW
48	Pedal Voice 2 Brilliance	○	[00-06]	○	[00-06]	00:BRILLIANT, 06:MELLOW
49	Lead Voice 2 Brilliance	○	[00-06]	○	[00-06]	00:BRILLIANT, 06:MELLOW

Sustain

cc	Switch	dd				Remarks
		Receive	Rx Range	Transmit	Tx Range	
50	Upper Sustain [UPPER (KNEE)]	○	[00-01]	○	[00-01]	00:OFF, 01:ON
51	Lower Sustain [LOWER (KNEE)]	○	[00-01]	○	[00-01]	00:OFF, 01:ON
52	Pedal Sustain [PEDAL]	○	[00-01]	○	[00-01]	00:OFF, 01:ON

Solo Bar

cc	Switch	dd				Remarks
		Receive	Rx Range	Transmit	Tx Range	
59	Solo Bar	○	[00-01]	×	-	00:OFF, 01:ON

Keyboard Percussion

cc	Switch	dd				Remarks
		Receive	Rx Range	Transmit	Tx Range	
5B	Keyboard Percussion [1]	○	[00-01]	○	[00-01]	00:OFF, 01:ON
5C	Keyboard Percussion [2]	○	[00-01]	○	[00-01]	00:OFF, 01:ON

Disable

cc	Switch	dd				Remarks
		Receive	Rx Range	Transmit	Tx Range	
5F	Disable [D.]	○	[00-01]	○	[00-01]	00:OFF, 01:ON

Rotary Speaker

cc	Switch	dd				Remarks
		Receive	Rx Range	Transmit	Tx Range	
60	Rotary Speaker Speed [ROTARY SP SPEED]	○	[00-01]	○	[00-01]	00:OFF, 01:ON

Rhythm Sequence

cc	Switch	dd				Remarks
		Receive	Rx Range	Transmit	Tx Range	
61	Sequence 1 [SEQ.1]	○	[00-01]	○	[00-01]	00:OFF, 01:ON
62	Sequence 2 [SEQ.2]	○	[00-01]	○	[00-01]	00:OFF, 01:ON
63	Sequence 3 [SEQ.3]	○	[00-01]	○	[00-01]	00:OFF, 01:ON
64	Sequence 4 [SEQ.4]	○	[00-01]	○	[00-01]	00:OFF, 01:ON

*3. MIDI Parameter

Voice Section Parameters

Panel Voice Parameters

(Address mm: 0 – 7 = UK1, UK2, LK1, LK2, LEAD 1, LEAD 2, PEDAL 1, PEDAL 2)

MIDI Exclusive Format

F0, 43, 70, 78, 44, hh, mm, ll, ..., F7

Address			Size	Data	Parameter	Data	Receive	Rx Range	Transmit	Tx Range
hh	mm	ll								
10	00-07	00-0D	5	00-7F 00-7F 00-02 00 00	Voice Assign Number	00-7F 00-7F 00-02 00 00	○	00-7F 00-7F 00-02 00 00	○	00-7F 00-7F 00-02 00 00
10	00-07	10	1	00-0D	Voice Selector Number	00-0D	○	00-0D	○	00-0D
10	00-07	11	1	00-7F	Volume	00:MIN 7F:MAX	○	00-7F	×	-
10	00-07	12	1	00-7F	Reverb (Send Level)	00:MIN 7F:MAX	○	00-7F	○	00-7F
10	00-07	13	1	00-7F	Brilliance	00:BRILLIANT 40:CENTER 7F:MELLOW	○	00-7F	×	-
10	00-07	14	1	00-04	Feet	00:PRESET 01:16' 02:8' 03:4' 04:2'	○	00-7F	○	00-04
10	00-07	15	1	00-7F	Pan	00:LEFT 40:CENTER 7F:RIGHT	○	00-7F	○	08-78
10	00-07	16	1	00-7F	Touch Tone Initial Touch	00:MIN 7F:MAX	○	00-7F	○	00-7F
10	00-07	17	1	00-7F	Touch Tone After Touch	00:MIN 7F:MAX	○	00-7F	○	00-7F
10	00-07	18	1	00-7F	Pitch After Touch	00:NARROW 7F:WIDE	○	00-7F	○	32-4E
10	00-07	19	1	00-7F	User Vibrato	00:PRESET 01:USER	○	00-7F	○	00-01
10	00-07	1A	1	00-7F	Vibrato Delay	00:SHORT 7F:LONG	○	00-7F	○	02-1A
10	00-07	1B	1	00-7F	Vibrato Depth	00:MIN 7F:MAX	○	00-7F	○	00-54
10	00-07	1C	1	00-7F	Vibrato Speed	00:SLOW 7F:FAST	○	00-7F	○	3C-6C
10	00-05	1D	1	00-7F	Pitch Horizontal Touch	00:NARROW 7F:WIDE	○	00-7F	○	00-7F
10	00-07	1E	1	00-7F	Touch Vibrato (On/Off)	00:OFF 7F:ON	○	00-7F	○	00-7F
10	04-07	1F	1	00-7F	TO LOWER▼/▲/SOLO (KNEE)	00:OFF 01:ON	○	00-7F	×	-
10	04-05	20	1	00-02	Slide (On/Knee Lever/Off)	00:OFF 01:ON 02:Knee Lever	○	00-02	○	00-02
10	04-05	21	1	00-7F	Slide Time	00:FAST 7F:SLOW	○	00-7F	○	02-7F
10	00-07	22	1	00-7F	Tune/Detune	00:Down 40:Center 7F:Up	○	00-7F	○	00-7F
10	00-01/ 04-07	23	1	00-7F	2nd Expression Pitch Bend	00:OFF 01:ON	○	00-7F	○	00-01
10	00-05	24	1	00-7F	Footswitch Glide Control	00:OFF 01:ON	○	00-7F	○	00-01
10	00-07	25	1	3A-46	Transpose	3A:KeyDown 40:Normal 46:KeyUp	○	3A-46	○	3A-46
10	06-07	28	1	00-7F	Poly (On/Off)	00:Mono 01:Poly	○	00-7F	○	00-01
10	05	29	1	00-7F	Priority (Last/Top)	00:TOP 01:LAST	○	00-7F	○	00-01
10	00-07	2A	1	00-7F	Volume Mute	00:Mute OFF 01:Mute ON	○	00-7F	○	00-01

Address			Size	Data	Parameter	Data	Receive	Rx Range	Transmit	Tx Range
hh	mm	ll								
10	00-07	40	3	00 00-7F 00-7F	Effect 1 Type MSB/LSB	00 00-7F 00-7F	○	00 00-7F 00-7F	○	00 00-7F 00-7F
10	00-07	41	2	0000-7F7F	Effect 1 Parameter 1 MSB/LSB	0000-7F7F	○	0000-7F7F	○	0000-7F7F
10	00-07	42	2	0000-7F7F	Effect 1 Parameter 2 MSB/LSB	0000-7F7F		0000-7F7F		0000-7F7F
10	00-07	43	2	0000-7F7F	Effect 1 Parameter 3 MSB/LSB	0000-7F7F		0000-7F7F		0000-7F7F
10	00-07	44	2	0000-7F7F	Effect 1 Parameter 4 MSB/LSB	0000-7F7F		0000-7F7F		0000-7F7F
10	00-07	45	2	0000-7F7F	Effect 1 Parameter 5 MSB/LSB	0000-7F7F		0000-7F7F		0000-7F7F
10	00-07	46	2	0000-7F7F	Effect 1 Parameter 6 MSB/LSB	0000-7F7F		0000-7F7F		0000-7F7F
10	00-07	47	2	0000-7F7F	Effect 1 Parameter 7 MSB/LSB	0000-7F7F		0000-7F7F		0000-7F7F
10	00-07	48	2	0000-7F7F	Effect 1 Parameter 8 MSB/LSB	0000-7F7F		0000-7F7F		0000-7F7F
10	00-07	49	2	0000-7F7F	Effect 1 Parameter 9 MSB/LSB	0000-7F7F		0000-7F7F		0000-7F7F
10	00-07	4A	2	0000-7F7F	Effect 1 Parameter 10 MSB/LSB	0000-7F7F		0000-7F7F		0000-7F7F
10	00-07	4B	2	0000-7F7F	Effect 1 Parameter 11	0000-7F7F		0000-7F7F		0000-7F7F
10	00-07	4C	2	0000-7F7F	Effect 1 Parameter 12	0000-7F7F		0000-7F7F		0000-7F7F
10	00-07	4D	2	0000-7F7F	Effect 1 Parameter 13	0000-7F7F		0000-7F7F		0000-7F7F
10	00-07	4E	2	0000-7F7F	Effect 1 Parameter 14	0000-7F7F		0000-7F7F		0000-7F7F
10	00-07	4F	2	0000-7F7F	Effect 1 Parameter 15	0000-7F7F		0000-7F7F		0000-7F7F
10	00-07	50	2	0000-7F7F	Effect 1 Parameter 16	0000-7F7F		0000-7F7F		0000-7F7F
10	00-07	51	3	00 00-7F 00-7F	Effect 2 Type MSB/LSB	00 00-7F 00-7F	○	00 00-7F 00-7F	○	00 00-7F 00-7F
10	00-07	52	2	0000-7F7F	Effect 2 Parameter 1 MSB/LSB	0000-7F7F	○	0000-7F7F	○	0000-7F7F
10	00-07	53	2	0000-7F7F	Effect 2 Parameter 2 MSB/LSB	0000-7F7F		0000-7F7F		0000-7F7F
10	00-07	54	2	0000-7F7F	Effect 2 Parameter 3 MSB/LSB	0000-7F7F		0000-7F7F		0000-7F7F
10	00-07	55	2	0000-7F7F	Effect 2 Parameter 4 MSB/LSB	0000-7F7F		0000-7F7F		0000-7F7F
10	00-07	56	2	0000-7F7F	Effect 2 Parameter 5 MSB/LSB	0000-7F7F		0000-7F7F		0000-7F7F
10	00-07	57	2	0000-7F7F	Effect 2 Parameter 6 MSB/LSB	0000-7F7F		0000-7F7F		0000-7F7F
10	00-07	58	2	0000-7F7F	Effect 2 Parameter 7 MSB/LSB	0000-7F7F		0000-7F7F		0000-7F7F
10	00-07	59	2	0000-7F7F	Effect 2 Parameter 8 MSB/LSB	0000-7F7F		0000-7F7F		0000-7F7F
10	00-07	5A	2	0000-7F7F	Effect 2 Parameter 9 MSB/LSB	0000-7F7F		0000-7F7F		0000-7F7F
10	00-07	5B	2	0000-7F7F	Effect 2 Parameter 10 MSB/LSB	0000-7F7F		0000-7F7F		0000-7F7F
10	00-07	5C	2	0000-7F7F	Effect 2 Parameter 11	0000-7F7F		0000-7F7F		0000-7F7F
10	00-07	5D	2	0000-7F7F	Effect 2 Parameter 12	0000-7F7F		0000-7F7F		0000-7F7F
10	00-07	5E	2	0000-7F7F	Effect 2 Parameter 13	0000-7F7F		0000-7F7F		0000-7F7F
10	00-07	5F	2	0000-7F7F	Effect 2 Parameter 14	0000-7F7F		0000-7F7F		0000-7F7F
10	00-07	60	2	0000-7F7F	Effect 2 Parameter 15	0000-7F7F		0000-7F7F		0000-7F7F
10	00-07	61	2	0000-7F7F	Effect 2 Parameter 16	0000-7F7F		0000-7F7F		0000-7F7F
10	00-07	63	1	00-7F	Sustain Length	7F:Hold 7E:Long 00:Short	○	00-7F	○	00-7F

Organ Flute Voice Parameters (Address mm: 0 – 1 = UK, LK)

Address			Size	Data	Parameter	Data	Receive	Rx Range	Transmit	Tx Range
hh	mm	ll								
11	00-01	00	1	00-7F	Footage 16'	00:MIN 7F:MAX	○	00-7F	○	00-7F
11	00-01	01	1	00-7F	Footage 8'	00:MIN 7F:MAX	○	00-7F	○	00-7F
11	00-01	02	1	00-7F	Footage 5-1/3'	00:MIN 7F:MAX	○	00-7F	○	00-7F
11	00-01	03	1	00-7F	Footage 4'	00:MIN 7F:MAX	○	00-7F	○	00-7F
11	00-01	04	1	00-7F	Footage 2-2/3'	00:MIN 7F:MAX	○	00-7F	○	00-7F
11	00-01	05	1	00-7F	Footage 2'	00:MIN 7F:MAX	○	00-7F	○	00-7F
11	00-01	06	1	00-7F	Footage 1-3/5'	00:MIN 7F:MAX	○	00-7F	○	00-7F
11	00-01	07	1	00-7F	Footage 1-1/3'	00:MIN 7F:MAX	○	00-7F	○	00-7F
11	00-01	08	1	00-7F	Footage 1'	00:MIN 7F:MAX	○	00-7F	○	00-7F
11	00-01	09	1	00-7F	Response	00:FAST 7F:SLOW	○	00-7F	○	00-7F
11	00-01	0A	1	00-7F	Attack 4'	00:MIN 7F:MAX	○	00-7F	○	00-7F
11	00-01	0B	1	00-7F	Attack 2-2/3'	00:MIN 7F:MAX	○	00-7F	○	00-7F
11	00-01	0C	1	00-7F	Attack 2'	00:MIN 7F:MAX	○	00-7F	○	00-7F
11	00-01	0D	1	00-7F	Attack Length	00:Short 7F:Long	○	00-7F	○	00-7F
11	00-01	10	1	00-7F	Organ Flutes (On/Off)	00:OFF 01:ON	○	00-7F	×	-
11	00-01	11	1	00-7F	Volume	00:MIN 7F:MAX	○	00-7F	○	00-7F
11	00-01	12	1	00-7F	Reverb (Send Level)	00:MIN 7F:MAX	○	00-7F	○	00-7F
11	00-01	13	1	00-7F	Type (Sine/Vintage)	00:Sine 01:Vintage	○	00-7F	○	00-01
11	00-01	40	3	00 00-7F 00-7F	Effect Type MSB/LSB	00 00-7F 00-7F	○	00 00-7F 00-7F	○	00 00-7F 00-7F
11	00-01	41	2	0000-7F7F	Effect Parameter 1 MSB/LSB	0000-7F7F	○	0000-7F7F	○	0000-7F7F
11	00-01	42	2	0000-7F7F	Effect Parameter 2 MSB/LSB	0000-7F7F	○	0000-7F7F	○	0000-7F7F
11	00-01	43	2	0000-7F7F	Effect Parameter 3 MSB/LSB	0000-7F7F	○	0000-7F7F	○	0000-7F7F
11	00-01	44	2	0000-7F7F	Effect Parameter 4 MSB/LSB	0000-7F7F	○	0000-7F7F	○	0000-7F7F
11	00-01	45	2	0000-7F7F	Effect Parameter 5 MSB/LSB	0000-7F7F	○	0000-7F7F	○	0000-7F7F
11	00-01	46	2	0000-7F7F	Effect Parameter 6 MSB/LSB	0000-7F7F	○	0000-7F7F	○	0000-7F7F
11	00-01	47	2	0000-7F7F	Effect Parameter 7 MSB/LSB	0000-7F7F	○	0000-7F7F	○	0000-7F7F
11	00-01	48	2	0000-7F7F	Effect Parameter 8 MSB/LSB	0000-7F7F	○	0000-7F7F	○	0000-7F7F
11	00-01	49	2	0000-7F7F	Effect Parameter 9 MSB/LSB	0000-7F7F	○	0000-7F7F	○	0000-7F7F
11	00-01	4A	2	0000-7F7F	Effect Parameter 10 MSB/LSB	0000-7F7F	○	0000-7F7F	○	0000-7F7F
11	00-01	4B	2	0000-7F7F	Effect Parameter 11	0000-7F7F	○	0000-7F7F	○	0000-7F7F
11	00-01	4C	2	0000-7F7F	Effect Parameter 12	0000-7F7F	○	0000-7F7F	○	0000-7F7F
11	00-01	4D	2	0000-7F7F	Effect Parameter 13	0000-7F7F	○	0000-7F7F	○	0000-7F7F
11	00-01	4E	2	0000-7F7F	Effect Parameter 14	0000-7F7F	○	0000-7F7F	○	0000-7F7F
11	00-01	4F	2	0000-7F7F	Effect Parameter 15	0000-7F7F	○	0000-7F7F	○	0000-7F7F
11	00-01	50	2	0000-7F7F	Effect Parameter 16	0000-7F7F	○	0000-7F7F	○	0000-7F7F
11	00-01	63	1	00-7F	Sustain Length	7F:Hold 7E:Long 00:Short	○	00-7F	○	15-3D, 7F

Keyboard Parameters

Sustain Parameters (Address mm: 0 – 2 = UK, LK, PEDAL)

Address			Size	Data	Parameter	Data	Receive	Rx Range	Transmit	Tx Range
hh	mm	ll								
12	00-02	00	1	00-7F	Sustain (On/Off)	00:OFF 01:ON	○	00-7F	×	-
12	00-02	01	1	00-7F	Length	00:Short 7F:Long	○	00-7F	×	-

Keyboard Percussion Parameters (Address mm: 1 – 2 = K.B.P. [1], K.B.P. [2])

Address			Size	Data	Parameter	Data	Receive	Rx Range	Transmit	Tx Range
hh	mm	ll								
12	01-02	10	1	00-7F	Keyboard Percussion (On/Off)	00:OFF 01:ON	○	00-7F	×	-
12	01-02	11	1	00-08	Keyboard Percussion Menu	00:PRESET 01:USER 1 02:USER 2 03:USER 3 04:USER 4 05:USER 5 06:USER 6 07:USER 7 08:USER 8	○	00-08	○	00-08

Rhythm

Rhythm Parameters

Address			Size	Data	Parameter	Data	Receive	Rx Range	Transmit	Tx Range
hh	mm	ll								
13	00	00-0B	2	0000-7F7F	Rhythm Assign Number	0000-7F7F	○	00-7F 00-7F	○	00-7F 00-7F
13	00	10	1	00-0B	Rhythm Selector Number	00-0B	○	00-0B	○	00-0B
13	00	11	1	00-7F	Percussion Volume	00:MIN 7F:MAX	○	00-7F	×	-
13	00	12	1	00-7F	Percussion Reverb (Send Level)	00:MIN 7F:MAX	○	00-7F	○	00-7F
13	00	13	1	00-7F	2nd Expression Tempo Control (On/Off)	00:OFF 01:ON	○	00-7F	○	00-01
13	00	14	1	00-7F	Footswitch Rhythm Control	00:INTRO 1 01:INTRO 2 02:INTRO 3 08:MAIN A 09:MAIN B 0A:MAIN C 0B:MAIN D 18:BREAK 20:ENDING 1 21:ENDING 2 22:ENDING 3 7E:STOP 7F:OFF (INTRO 1 – STOP)	○	00-7F	○	00-7F
13	00	15	1	00-7F	Add Drum (On/Off)	00:OFF 01:ON	○	00-7F	○	00-01
13	00	16	1	00-7F	Main Drum (On/Off)	00:OFF 01:ON	○	00-7F	○	00-01
13	00	17	1	00-7F	Chord 1 (On/Off)	00:OFF 01:ON	○	00-7F	○	00-01
13	00	18	1	00-7F	Chord 2 (On/Off)	00:OFF 01:ON	○	00-7F	○	00-01
13	00	19	1	00-7F	Pad (On/Off)	00:OFF 01:ON	○	00-7F	○	00-01
13	00	1A	1	00-7F	Phrase 1 (On/Off)	00:OFF 01:ON	○	00-7F	○	00-01
13	00	1B	1	00-7F	Phrase 2 (On/Off)	00:OFF 01:ON	○	00-7F	○	00-01
13	00	1C	1	00-7F	Auto Fill (On/Off)	00:OFF 01:ON	○	00-7F	○	00-01

Rhythm Sequence Parameters

Address			Size	Data	Parameter	Data	Receive	Rx Range	Transmit	Tx Range
hh	mm	ll								
13	01	00-03	1	00-7F	Sequence [SEQ.1] – [SEQ.4]	00:OFF 01:ON	○	00-7F	×	-

Accompaniment Parameters

Address			Size	Data	Parameter	Data	Receive	Rx Range	Transmit	Tx Range
hh	mm	ll								
13	02	11	1	00-7F	Accompaniment Volume	00:MIN 7F:MAX	○	00-7F	○	00-7F
13	02	12	1	00-7F	Accompaniment Reverb (Send Level)	00:MIN 7F:MAX	○	00-7F	○	00-7F

A.B.C. Function Parameters

Address			Size	Data	Parameter	Data	Receive	Rx Range	Transmit	Tx Range
hh	mm	ll								
13	03	00	1	00-7F	Auto Bass Chord Mode	00:OFF 01:Single Finger 02:Fingered 03:Custom A.B.C.	○	00-7F	○	00-03
13	03	01	1	00-7F	Lower Memory (On/Off)	00:OFF 01:ON	○	00-7F	○	00-01
13	03	02	1	00-7F	Pedal Memory (On/Off)	00:OFF 01:ON	○	00-7F	○	00-01

M.O.C. Function Parameters

Address			Size	Data	Parameter	Data	Receive	Rx Range	Transmit	Tx Range
hh	mm	ll								
13	04	00	1	00-7F	Melody On Chord Mode	00:OFF 01:1 02:2 03:3	○	00-7F	○	00-03
13	04	01	1	00-7F	M.O.C. Knee Lever Control (On/Off)	00:OFF 01:ON	○	00-7F	○	00-01

Section Parameters

Address			Size	Data	Parameter	Data	Receive	Rx Range	Transmit	Tx Range
hh	mm	ll								
13	05	00	1	00-7F	Intro 1 (On/Off)	00:OFF 01:ON	○	00-7F	○	00-01
13	05	01	1	00-7F	Intro 2 (On/Off)	00:OFF 01:ON	○	00-7F	○	00-01
13	05	02	1	00-7F	Intro 3 (On/Off)	00:OFF 01:ON	○	00-7F	○	00-01
13	05	08	1	00-7F	Main A (On/Off)	00:OFF 01:ON	○	00-7F	○	00-01
13	05	09	1	00-7F	Main B (On/Off)	00:OFF 01:ON	○	00-7F	○	00-01
13	05	0A	1	00-7F	Main C (On/Off)	00:OFF 01:ON	○	00-7F	○	00-01
13	05	0B	1	00-7F	Main D (On/Off)	00:OFF 01:ON	○	00-7F	○	00-01
13	05	18	1	00-7F	Break (On/Off)	00:OFF 01:ON	○	00-7F	○	00-01
13	05	20	1	00-7F	Ending 1 (On/Off)	00:OFF 01:ON	○	00-7F	○	00-01
13	05	21	1	00-7F	Ending 2 (On/Off)	00:OFF 01:ON	○	00-7F	○	00-01
13	05	22	1	00-7F	Ending 3 (On/Off)	00:OFF 01:ON	○	00-7F	○	00-01

Keyboard Percussion Parameters

Address			Size	Data	Parameter	Data	Receive	Rx Range	Transmit	Tx Range
hh	mm	ll								
13	10	11	1	00-7F	Volume	00:MIN 7F:MAX	○	00-7F	○	00-7F
13	10	12	1	00-7F	Reverb (Send Level)	00:MIN 7F:MAX	○	00-7F	○	00-7F

Overall

System Parameters

Address			Size	Data	Parameter	Data	Receive	Rx Range	Transmit	Tx Range
hh	mm	ll								
14	00	00	1	00-7F	Disable (On/Off)	00:OFF 01:ON	○	00-7F	×	-
14	00	01	1	00-7F	Organ Flute Attack Mode	00:Each 01:First	○	00-7F	○	00-01
14	00	02	1	3A-46	Transpose	3A:KeyDown 40:Normal 46:KeyUp	○	3A-46	○	3A-46
14	00	03	1	01-0C	2nd Expression Range	01:100 C 0C:1200 C	○	01-0C	○	01-0C
14	00	04	1	00-7F	Footswitch Mode	00:OFF 01:Rhythm 02:Glide 03:Rotary Speaker	○	00-7F	○	00-03
14	00	05	1	00-7F	Pitch	00:PitchDown 40:Normal 7F:PitchUp	○	00-7F	○	00-7F
14	00	06	1	00-7F	Footswitch Glide Time	00:FAST 7F:SLOW	○	00-7F	○	04-1C
14	00	08	1	00-7F	MIDI Control Expression (INT/EXT)	00:Internal 01:External	○	00-7F	×	-
14	00	09	1	00-7F	MIDI Control Lead 1 (INT/EXT)	00:Internal 01:External	○	00-7F	×	-
14	00	0A	3	00-04 00-04 (00-03)* 00-0B	Registration Menu	00-04 00-04 (00-03) 00-0B	○	00-04 00-04 (00-03) 00-0B	○	00-04 00-04 (00-03) 00-0B
14	00	0B	1	00-01	Disable Mode	00:Normal 01:Tempo	○	00-01	○	00-01

*ELS-01

Effect Parameters (Overall): Reverb

Address			Size	Data	Parameter	Data	Receive	Rx Range	Transmit	Tx Range
hh	mm	ll								
14	01	00	1	00-7F	Reverb Depth	00:MIN 7F:MAX	○	00-7F	×	-
14	01	01	1	00-7F	Reverb Time (Panel)	00:FAST 7F:SLOW	○	00-7F	○	00-45
14	01	02	3	00 00-7F 00-7F	Reverb Type (Panel)	00 00-7F 00-7F	○	00 00-7F 00-7F	○	00 00-7F 00-7F

Effect Parameters (Overall): Rhythm Reverb

Address			Size	Data	Parameter	Data	Receive	Rx Range	Transmit	Tx Range
hh	mm	ll								
14	02	01	1	00-7F	Reverb Time (Rhythm)	00:FAST 7F:SLOW	○	00-7F	○	00-45
14	02	02	3	00 00-7F 00-7F	Reverb Type (Rhythm)	00 00-7F 00-7F	○	00 00-7F 00-7F	○	00 00-7F 00-7F

Effect Parameters (Overall): Rotary Speaker

Address			Size	Data	Parameter	Data	Receive	Rx Range	Transmit	Tx Range
hh	mm	ll								
14	03	00	1	00-7F	Rotary Speaker Speed (On/Off)	00:OFF 01:ON	○	00-7F	×	-
14	03	01	1	00-7F	Rotary Speaker Speed Control Mode	00:STOP 01:SLOW	○	00-7F	○	00-01
14	03	02	2	0000-007F	Rotary Speaker Speed Control Speed	0000:SLOW 007F:FAST	○	0000-007F	○	0040-007F

*4. MDR

nn	Command	Receive	Transmit
01H	Play Start	○	×
02H	Play Stop	○	×
03H	Record Start	○	×
04H	Record Stop	○	×
05H	Fast Forward Start	○	×
06H	Fast Forward Stop	○	×
09H	Rhythm Pointer Reset	○	×

MIDI Implementation Chart

YAMAHA [Electone-EL mode] / Model: ELS-01/01C typeU

Date: 10-Oct-2008
Version: 1.00

Function	Transmitted	Recognized	Remarks
Basic Channel Default Changed	1, 2, 3, 16 (*1) 1-16	1-3, 5-16 (*2) 4	
Mode Default Messages Altered	Mode 3 × *****	Mode 3 × ×	
Note Number :True Voice	36-96 (*3) *****	0-127 (*4)	
Velocity Note on Note off	○ 9nH, v=1-127 × 9nH, v=0	○ 9nH, v=1-127 × 9nH, v=0 or 8nH	
After Touch Key's Ch's	× ○	○ (*6) ○	
Pitch Bend	○ (*5)	○	
Control Change 0, 32 1, 5, 7, 10 4 6, 38 11 16 96, 97 64-67 71-78 84, 91, 93, 94 98-99, 100-101	× × ○ (*7, *12) × ○ (*7) ○ (*8, *12) × × × × × ×	○ (*6) ○ (*6) ○ (*7) ○ (*6) ○ (*6, 7) ○ (*8, *12) ○ (*6) ○ (*6) ○ (*6) ○ (*6) ○ (*6) ○ (*6)	Bank Select 2nd Expression Data Entry Expression VA After Touch Data Entry SW Sound Controller NRPN, RPN
Program Change :True number	○ (*10) *****	○ (*11)	
System Exclusive	○	○	
System Common :Song Position :Song Select :Tune	× × ×	× × ×	
System Real Time :Clock :Commands	○ ○	○ (*9) ○	(FAH, FCH)
Aux Messages :All Sound Off :Reset All Cntrls :Local On/Off :All Notes Off :Active Sense :Reset	× × × × ○ ×	○ (120) (*6) ○ (121) (*6) × ○ (123-127) (*6) ○ ×	
Notes	*1: 1ch: UK, 2ch: LK, 3ch: PEDAL, 16ch: CONTROL *2: 1ch: UK, 2ch: LK, 3ch: PEDAL, 4ch: LEAD1, 5-14ch: XG, 15ch: KEYBOARD PERCUSSION, 16ch: CONTROL *3: UK: 36-96, LK: 36-96, PEDAL: 36-60 *4: UK, LK, PEDAL, LEAD1: 36-96, XG: 0-127, PERCUSSION: 3-127 *5: UK: UK HorizontalTouch, LK: LK HorizontalTouch *6: XG only *7: CONTROL only *8: UK only *9: External Mode only *10: CONTROL: 0-15 *11: UK, LK, PEDAL, CONTROL: 0-15 XG: 0-127 *12: ELS-01C only		

Mode 1 : OMNI ON, POLY
Mode 3 : OMNI OFF, POLY

Mode 2 : OMNI ON, MONO
Mode 4 : OMNI OFF, MONO

○ : Yes
× : No

Function		Transmitted (*1)	Recognized	Remarks
Basic Channel	Default Changed	1, 2, 3, 16 1-16	1-16 1-16	
Mode	Default Messages Altered	Mode3 × *****	Mode 3 × ×	
Note Number	:True Voice	36-96 *****	0-127	
Velocity	Note on Note off	○ 9nH, v=1-127 × 9nH, v=0	○ 9nH, v=1-127 × 9nH, v=0 or 8nH	
After Touch	Key's Ch's	× ○	○ ○	
Pitch Bend		○	○	
Control Change	0, 32 1, 5, 7, 10 4 6, 38 11 16 96, 97 64-67 71-78 84, 91, 93, 94 98-99, 100-101	× × ○ (*2) × ○ ○ (*2) × × × × × ×	○ ○ × ○ ○ × ○ ○ ○ ○ ○ ○	Bank Select 2nd Expression Data Entry Expression VA After Touch Data Entry SW Sound Controller NRPN, RPN
Program Change	:True number	○ 0-15 *****	○	
System Exclusive		○	○	
System Common	:Song Position :Song Select :Tune	× × ×	× × ×	
System Real Time	:Clock :Commands	○ ○	× ×	
Aux Messages	:All Sound Off :Reset All Cntrls :Local On/Off :All Notes Off :Active Sense :Reset	× × × × ○ ×	○ (120) ○ (121) × ○ (123-127) ○ ×	
Notes		*1; Same as that in the EL mode *2; ELS-01C only		

Mode 1 : OMNI ON, POLY
Mode 3 : OMNI OFF, POLY

Mode 2 : OMNI ON, MONO
Mode 4 : OMNI OFF, MONO

○ : Yes
× : No

Troubleshooting

Problem	Possible Cause and Solution
GENERAL OPERATION	
The sound is not heard for about 10 seconds after turning the power on.	This is normal; the Electone takes a while to start up.
A cracking noise is sometimes heard.	Noise may be produced when either an electrical appliance is turned on or an electric power tool (such as drill) is used in the proximity of the Electone. If this occurs, plug the Electone into an electrical outlet located as far as possible from the device that seems to be the source of the problem.
Interference from radio, TV, or other sources occurs.	This is caused by the proximity of a high-power broadcasting station, an amateur ham radio setup or a mobile phone.
The sound of the Electone causes surrounding objects to resonate.	Because the Electone is capable of producing powerful bass sounds, resonance may be caused in surrounding objects, such as cabinets or glass windows. To avoid this, relocate the objects or lower the Electone's volume.
In the LCD display, there are some black points (unlit) or white points (always lit).	Unfortunately, this is a common characteristic of TFT-LCDs.
Some buttons on the panel do not respond.	The UPPER/LOWER ORGAN FLUTES and LEAD VOICE 2 buttons are invalid on the ELS-01. If you upgrade the ELS-01 to the ELS-01C, these buttons can be used.
Some of the LEDs in the DISPLAY SELECT section do not light.	The LEDs of on/off buttons (UPPER/LOWER ORGAN FLUTES, VOICE EDIT, RHYTHM PROGRAM, and ROTARY SP SPEED) are lit when those functions are turned on. The LEDs of other function's buttons momentarily light when the functions are selected.
The sound is too small even when the volume is set to its maximum.	<ul style="list-style-type: none"> • The Master Volume may be set around the minimum position. Turn it clockwise. • The Expression Pedal may not be pressed down. Press it down with your toe. • The POWER switch of the speaker may have been turned off. Turn it on. • (For the ELS-01C) The REAR SPEAKER switch may have been set to OFF. Switch it to ON.
The Electone panel does not function normally or the content of the memorized data has changed.	This happens very rarely. Occasionally, power surges and spikes due to electrical storms or other reasons may cause the Electone to malfunction and/or alter the contents of memorized data. If this happens, perform the Factory Set operation to reset the Electone (page 21).
VOICES/RHYTHMS	
The pitch may sound excessively high on the Pedalboard and low in the higher registers of the Lower and Upper keyboards.	This may occur when you compare the Electone's sounds with that of a piano. Because of the difference of the harmonics structure, the tuning system of the Electone is different from the piano in the higher and lower ranges.
Some of the Voices may contain cracking and/or noisy sounds.	You may find these mainly in the wind instrument Voices. These are purposely added effects to the Voices to reproduce the characteristics of the wind instruments such as the pipe vibrations, breath noises and squeaks.
When too many keys are pressed, not all of the notes sound.	Total polyphonic capacity (notes sounding for both Upper and Lower Keyboards) is 14 notes. When you turn the Pedal Polyphonic mode to on, the total is 14 for all keyboards, Upper, Lower and Pedalboard.
When sustain length is set to HOLD, previously played notes are cut off.	Since the HOLD setting causes notes to keep sounding, the cumulative notes (elements) may go over the maximum elements that the Electone can sound. When this occurs, previously played notes are cut off.
Only one sound is heard when two notes of the Lead or Pedal Voices are simultaneously played.	For practical performance reasons, the Electone has been designed so that only one note of the Lead or Pedal Voices can be played at a time. If you want, the pedal Voice can be set to polyphonic mode (page 40).
The Pedal Voices do not sound, even though the volume is properly set.	<ul style="list-style-type: none"> • The Single Finger or Fingered Chord mode of Auto Bass Chord is on. Turn off the mode in the display (page 62). • TO LOWER buttons in the Pedal Voice sections are turned on. Turn the function off (page 26).

Problem	Possible Cause and Solution
When selecting a User button Voice or rhythm, the Voice or rhythm title at the top of the LCD does not match the selected Voice or rhythm.	The currently assigned Voice or rhythm is displayed at the top of the LCD, and remains until another Voice or rhythm has been selected.
When keys are pressed, the sounds of percussion instruments are also heard.	The Keyboard Percussion function has been turned on. When not using the function, be sure to turn it off (page 65).
Even though a User button's rhythm has been selected and started, the pattern does not sound.	Since the User buttons contain User rhythms, no rhythm will sound if a pattern has not been saved to the selected User button.
EFFECTS	
The Touch Tone function does not operate.	Adjust the Touch Tone settings in the Voice Condition display (page 39).
The Reverb effect is not applied to the desired Voice sections, even when the REVERB button setting on the panel is increased.	Increase the Reverb depth for the desired Voice sections in Reverb Display Pages 2 – 4.
The Rotary Speaker effect cannot be heard, even when the [ROTARY SP SPEED] button in the DISPLAY SELECT section is on.	Rotary Speaker must be selected first in Voice Condition display Pages 3 and/or 4 (for panel Voices), or in the Organ Flute Voices ATTACK/VOLUME Page (for Organ Flute Voices).
ACCOMPANIMENT	
The pitch in the Single Finger mode does not change, even when pressing different keys of the keyboard.	Single Finger mode will only produce notes when played within a fixed octave interval on the Lower keyboard. If notes with the same letter name are pressed outside of that range, the chords that are sounded will share the same pitch.
While an Intro/Ending pattern is automatically playing, the Lower keyboard does not produce any sound, even when the keys are played.	Since the Accompaniment chords play automatically one after another, the Lower keyboard is designed not to produce any sound during the playback of an Intro/Ending pattern.
The Accompaniment cannot be heard even when an appropriate Accompaniment type is selected and the rhythm has been started.	<ul style="list-style-type: none"> • The Accompaniment volume may have been set to 0. Be sure to raise the Accompaniment volume in the Rhythm Condition display (page 62). • All Accompaniment parts may be set to off (mute). Set the desired part on (page 61).
The harmony notes of the Melody On Chord function cannot be heard.	The Upper keyboard has been set to sound only Lead Voices. Increase the volume of the Upper Keyboard Voices.
The bass phrase of the Auto Bass Cord cannot be heard.	The pedal polyphonic mode may be set to on. Turn it off in the Voice Condition display (page 40).
REGISTRATION MEMORY	
Certain functions have not been memorized to Registration Memory.	Some functions cannot be memorized. Refer to page 81.
VOICE EDITING	
The Voice Edit display cannot be called up even when the [VOICE EDIT] button is pressed.	The Voice Edit display cannot be called up by pressing only the [VOICE EDIT] button. While holding down the [VOICE EDIT] button, press the desired Voice button.
During Voice editing, the specified Voice isn't heard, even when the keyboard is played.	<ul style="list-style-type: none"> • The Element is turned to mute or its level is set to minimum. Turn it to on or increase the volume. • You may have played keys outside the range of Note Limit. Play only keys within the Note Limit range.
An error message appears while the Voice name is entered.	Voice name capacity is 16 characters. Delete the unnecessary letters or spaces.
RHYTHM PROGRAM	
During use of the Rhythm Pattern Program, no sound is produced even when you play a certain percussion sound.	If percussion sounds have been recorded while memory is full, no subsequently selected instruments can be heard or recorded. If necessary, erase some of the less necessary percussion sounds and play again.

Problem	Possible Cause and Solution
MUSIC DATA RECORDER	
The USB flash memory is not recognized.	The USB cable of the USB unit is disconnected. Firmly connect the cable to the USB TO DEVICE terminal.
Recording or playback cannot be performed.	<ul style="list-style-type: none"> • The part buttons in the Rec Standby display or Playing display may have been turned off. Turn the desired part to REC or PLAY. • The performance data is too large. The maximum limit for recording performance data is 1 MB. • The media is write-protected. Cancel the write-protect. • The media/folder may contain EL-format songs. You cannot record to the media/folder that contains EL-format songs. Create a new folder and record the song to it.
Recording is stopped before the performance is finished.	<ul style="list-style-type: none"> • The amount of recorded data on the media is close to the maximum limit. Either use another media or delete the data of unnecessary songs. • When you overwrite the song, the length of a subsequently recorded part cannot exceed the length of the previously recorded parts. Delete the previously recorded song, then record again (page 126). • The performance data is too large. The maximum limit for recording performance data is 1 MB.
An error message appears while entering a folder name or song name.	<ul style="list-style-type: none"> • The song/folder name is too long. The capacity is 50 letters. • The song/folder name may be an invalid name. Refer to page 110. • The path name is too long. The capacity of the path name is 234 letters. Reduce the layer or shorten the song/folder name to shorten the path.
The rhythm does not start at the beginning of a recording, or stops in the middle of the performance.	The M.D.R. is designed so that the rhythm cannot be started at the very beginning of a recording. If you wish to use the rhythm, start it after the time indicator appears in the display.
The floppy disk cannot be formatted when you want to format an unformatted disk.	Recognizing an unformatted disk takes a few seconds after it is inserted. Wait about 30 seconds, then try to format again.
The notes of the recording are "stuck" and sound continuously.	During playback, you may have removed the USB flash memory. Whenever you wish to stop playback, always press the [■] (Stop) button before removing the media.

Specifications

	Electone STAGEA ELS-01 typeU (ELS-01U)	Electone STAGEA ELS-01C typeU (ELS-01CU)
STONE GENERATION	AWM (4)	AWM (4) + VA + Organ Flutes
KEYBOARD	Upper: 49 keys (C – C), Lower: 49 keys (C – C), Pedal: 20 keys (C – G)	
Keyboard Type	Standard (FS)	Custom (FSV)
Initial Touch	Upper, Lower, Pedal	
After Touch	Upper, Lower	Upper, Lower, Pedal
Horizontal Touch	—	Upper, Lower
REGISTRATION	Registration Menu	240
	Registration Memory	M. (Memory), 1 – 16, D. (Disable)
	Registration Shift	Shift, Jump, User (80)
VOICE	Voice Sections	Upper 1, Upper 2, Lead 1, Lead 2, Lower 1, Lower 2, Pedal 1, Pedal 2
	Voice Buttons	UPPER/LOWER STRINGS, BRASS, WOODWIND, TUTTI, PAD, SYNTH, PIANO, ORGAN, PERCUSSION, GUITAR, CHOIR, WORLD, USER 1, USER 2
	Lead	VIOLIN, SYNTH, FLUTE, TRUMPET, USER 1, TO LOWER (Lead 1), SOLO (Lead 2)
	Pedal	CONTRABASS, ELEC. BASS, TIMPANI, SYNTH BASS, USER 1, TO LOWER
	Preset Voice	415
	User Voice	AWM: 16
	Organ Flute Voice	—
	Rotary Speaker Control	2.69 – 39.7 Hz, Slow, Stop
EFFECT/CONDITION	Sustain	Upper 1, 2 (KNEE), Lower 1, 2 (KNEE), Pedal 1, 2
	Reverb	Type: Hall 1 – 3, M, L, Room 1 – 4, S, M, L, Stage 1 – 2, Plate 1 – 2, White Room, Tunnel, Canyon, Basement, XG Hall 1 – 2, XG Room 1 – 3, XG Stage 1 – 2, XG Plate, GM Plate Depth: Upper 1 – 2, Lower 1 – 2, Lead 1 – 2, Pedal 1 – 2, Percussion, Accompaniment, Keyboard Percussion
	Effects	Reverb, Delay, ER/Karaoke, Chorus, Flanger, Phaser, Tremolo/Auto Pan, Rotary Speaker, Distortion, Distortion+, Wah, Dynamic, EQ/Enhancer, Pitch Change, Miscellaneous, Thru
RHYTHM	Rhythm Buttons	MARCH, WALTZ, SWING & JAZZ, POPS, R&B, LATIN, WORLD MUSIC, BALLAD, ROCK, DANCE, USER 1, USER 2
	Preset Rhythm Pattern	274
	Parts	Main Drum, Add Drum
	Sections	Intro 1 – 3, Ending 1 – 3, Main/Fill In A – D, Break, Auto Fill
ACCOMPANIMENT	Accompaniment Parts	Chord 1, Chord 2, Pad, Phrase1, Phrase 2
	Auto Bass Chord	OFF, Single Finger, Fingered Chord, Custom A.B.C. Memory: Lower, Pedal
	Melody On Chord	OFF, 1, 2, 3, Knee

		Electone STAGEA ELS-01 typeU (ELS-01U)	Electone STAGEA ELS-01C typeU (ELS-01CU)	
PROGRAMS	Voice Edit	✓		
	Rhythm Pattern Program	✓		
	Rhythm Sequence Program	SEQ. 1 – 4 (Rhythm and Registration program)		
	Keyboard Percussion	Preset 1 – 2, User 1 – 8		
CONTROLS	Footswitch Left	Rhythm: Stop, Break, Main A-D, Intro 1 – 3, Ending 1 – 3 Glide: Upper 1, 2, Lower 1, 2, Lead 1, 2, Glide Time Rotary Speaker Speed		
	Right	Registration Shift		
	Expression Pedal	✓		
	2nd Expression Pedal	Pitch Bend, Tempo (set only, not controlled)	Pitch Bend, Tempo	
	Knee Lever	Sustain (Upper 1, 2/Lower 1, 2), M.O.C., Lead Slide, Solo (Lead 2)		
	Transpose	-6 – +6		
	Pitch	A = 427.2 – 452.6 Hz		
	MIDI Control	✓		
	Main Controls	POWER on/off, MASTER VOLUME		
	M.D.R.	Up, In, Song Select: Stop, Play, Pause, Rewind, Fast Forward, Record, Custom Play, Score, Setting (Tempo/Part), Registration Edit Tools: Create Folder, Change Song Name, Copy, Delete, Conversion (XG/EL/ELS format), Format, Information		
	Utility	Language (English/Japanese), Touch Panel Sound, LCD Brightness, Mic. (Reverb/Volume), Disable Mode (Normal/Tempo), Initialize		
Display Select	VOICE DISPLAY, A.B.C./M.O.C., MDR, FOOTSWITCH, UTILITY, INTERNET, VOICE EDIT, RHYTHM PATTERN PROGRAM, RHYTHM SEQUENCE PROGRAM, ROTARY SP SPEED	VOICE DISPLAY, A.B.C./M.O.C., MDR, FOOTSWITCH, UTILITY, INTERNET, VOICE EDIT, RHYTHM PATTERN PROGRAM, RHYTHM SEQUENCE PROGRAM, U. ORGAN FLUTES, L. ORGAN FLUTES, ROTARY SP SPEED		
OTHERS	LCD Display	800 x RGB x 480 dots		
	Sound System	Power Amplifiers	50W x 2	70W x 2
		Speakers	Cone: 13 cm x 2, 5 cm x 2 Monitor speaker: 6.6 cm x 2	Cone: 13 cm x 8 Dome: 2.5 cm x 4 Monitor speaker: 6.6 cm x 2
	Storage	USB storage device (such as USB flash memory, USB floppy disk drive, etc.)		
	Connectors	PHONES (2), AUX OUT: L/L+R (standard phone), L/R (Level Fixed, RCA), AUX IN: L/L+R (standard phone), MIDI IN/OUT, USB TO DEVICE (2; one terminal has been connected to the USB unit.), OPTICAL OUT, MIC./LINE IN (jack, switch, and volume control)		
	Power Consumption	130W		
	Dimensions (W x D x H), Weight		1229 x 574 x 1017 (1276 with Music Rest) mm, 100 kg	1229 x 574 x 1017 (1276 with Music Rest) mm, 109 kg
		Bench	781 x 305 x 618 mm, 8.8 kg	915 x 365 x 618 mm, 12.1 kg
	Color	Silver Metallic		
	Supplied Accessories	Bench, Owner's Manual, Tutorial Guidebook, Product ID card		

Specifications and descriptions in this owner's manual are for information purposes only. Yamaha Corp. reserves the right to change or modify products or specifications at any time without prior notice. Since specifications, equipment or options may not be the same in every locale, please check with your Yamaha dealer.

Numerics

2nd Expression Pedal..... 190

A

A.B.C./M.O.C..... 62, 64
 ACCENT..... 152
 Accompaniment..... 61
 Add Drum..... 61
 AFTER touch (Pitch)..... 40
 AFTER touch (Touch Tone)..... 39
 ASSEMBLE..... 148
 ASSIGN (Keyboard Percussion)..... 70
 ATTACK (Organ Flutes)..... 36
 ATTACK RATE (Voice Edit)..... 137, 140
 Auto Bass Chord..... 62
 Auto Fill..... 54
 AUX IN..... 209
 AUX OUT..... 209
 AUX OUT (LEVEL FIXED)..... 209
 AWM (Voice Edit)..... 134
 AWM Voice..... 34

B

BAR/BEAT..... 56
 Bookmark..... 199
 BREAK..... 53
 BRILLIANCE (Panel)..... 47
 Browser..... 196, 203

C

CHANGE SONG NAME..... 108
 Channel Messages..... 219
 CHORD 1..... 61
 CHORD 2..... 61
 CHORUS (Effect)..... 50
 CHORUS (Rhythm Pattern Program)..... 164
 Control Change..... 219
 Control Menu..... 196
 CONVERT EL TO ELS..... 129
 CONVERT ELS TO EL..... 129
 CONVERT TO XG..... 128
 CUSTOM A.B.C..... 63
 CUTOFF FREQ..... 137

D

[D.] (Disable)..... 82
 DATA CONTROL dial..... 10
 DECAY RATE..... 140
 DELAY (Effect)..... 50
 DELAY (Vibrato)..... 41
 DEPTH (Reverb)..... 44
 DEPTH (Vibrato)..... 41
 Display Select..... 10
 DISTORTION..... 50
 DYNAMIC..... 50

E

EACH (Organ Flutes)..... 36
 EFFECT..... 42
 Effect category (Voice)..... 42
 Effect Parameters..... 43
 EFFECT TYPE (Organ Flutes)..... 37
 Effect type (Voice)..... 43
 Element..... 131
 ENDING..... 53
 Envelope Parameters..... 140
 EQ (Equalizer)..... 135, 140
 EQ/ENHANCER (Effect)..... 50
 ER/KARAOKE..... 50
 Expression pedal..... 12
 EXTERNAL..... 222

F

Factory Set..... 21
 Fast Forward..... 119
 FEET..... 40
 File..... 99
 FILL IN..... 53
 Filter..... 137
 FINGERED CHORD..... 63
 FIRST (Organ Flutes)..... 36
 FLANGER..... 50
 Floppy disk..... 101
 Folder..... 99
 FOOT SWITCH..... 86, 185
 FOOTAGE..... 35
 Footswitch..... 185
 FORMAT (MDR)..... 102

G

Gate Time..... 160
 Glide..... 187

H

Headphones..... 211
 Home Page..... 202
 HORIZONTAL touch..... 40

I

INITIAL touch..... 39
 Initialize (Factory Set)..... 21
 Initialize (Internet Settings)..... 206
 Initialize (Registration Memory)..... 85
 INPUT VOLUME..... 208
 INTERNAL..... 222
 INTERNET..... 195
 Internet Direct Connection..... 194
 INTRO..... 52

J	
Jacks and Controls	208
JUMP	86

K	
Keyboard Percussion	65
Knee Lever	188

L	
L. ORGAN FLUTES	35
LAN	204
LANGUAGE	15
LAST (Lead Voice)	40
LAYER (Voice Edit)	135
LCD BRIGHTNESS	16
LCD Display	10
Lead Slide	42
Lead Voice	22
LEAD VOICE (Panel)	9
LEVEL (Voice Edit)	136, 139
LFO (Low Frequency Oscillator)	139
Lower Keyboard Voice	23
LOWER KEYBOARD VOICE (Panel)	8

M	
[M.] (Memory)	80
M.O.C.	64
MAIN	52
Main Drum	61
MAIN/FILL IN	52
MASTER VOLUME	11
MDR	95
Melody On Chord	64
MEMORY (A.B.C.)	64
METRONOME	147
MIC./LINE IN jack	208
MIC./LINE switch	208
MIDI	218
MIDI Control	221
MIDI IN/OUT	210
MIDI OUT FILTER	221
MISCELLANEOUS	50
MODE (Organ Flutes)	36
MODE (Rotary Speaker)	49
Music Data Recorder	95

N	
Next Page	123
Next Regist	113
NEXT REGIST (Shift End)	88
NOTE LIMIT	136
NOTE SHIFT	136

O	
OPTICAL OUT	210
Organ Flutes	35
OUTPUT (MIDI)	221

P	
PAD	61
PAN (Voice Edit)	136
PAN (Voice)	39
Part (Rhythm)	61
PART SETUP (MDR)	104
PATTERN	144
Pause	119
Pedal polyphonic mode	40
Pedal Voice	23
PEDAL VOICE (Panel)	9
PHASER	50
PHONES	208
PHRASE 1	61
PHRASE 2	61
Pitch	193
PITCH (Voice Section)	40
Pitch Bend	191
PITCH CHANGE	50
Playback	117
POLY	40
POWER	11
PRESET (Vibrato)	41
Preset Keyboard Percussion	65
PRESET TEMPO	57
PRIORITY	40
Program Change	219
Protected Song	116
Punch-in Recording	108

Q	
Quantize	156

R	
Real Time Write	149, 157
Recording	105
Recording (Lead Voice 1 Voice only)	106
Recording (Part)	106
REGIST EDIT (MDR)	111
Registration Memory	80
REGISTRATION MENU	19
Registration Sequence	179
Registration Shift	85
RELEASE RATE (Voice Edit)	137, 140
Repeat	120
Re-recording (Retry)	106
RESONANCE	137
RESP. (Response)	36
Reverb	43
REVERB (MIC.)	215
REVERB (Panel)	43
REVERB (Rhythm Pattern Program)	163
Rewind	119
Rhythm	51
Rhythm button	51
Rhythm Clock	151
Rhythm Condition	54
Rhythm Menu	52
Rhythm Pattern Program	144
Rhythm Program	143

Rhythm Sequence Program.....	174
Rhythmic Chord.....	158
ROTARY SP SPEED.....	48
Rotary Speaker.....	48

S

SCORE.....	122
Sections.....	52
SEQUENCE.....	174
SHIFT (Registration Shift).....	86
SHIFT END.....	88
SINGLE FINGER.....	63
SLIDE.....	42
SLOW (Rotary Speaker).....	49
SOLO.....	27
Song.....	99, 103
Song Copy.....	124
Song Delete.....	126
Specifications.....	244
SPEED (Rotary Speaker).....	49
SPEED (Vibrato).....	41
START.....	53
Step Write.....	149
STOP (Rotary Speaker).....	49
STOP (Shift End).....	88
Style File Format.....	170
Sustain.....	47
SUSTAIN (Panel).....	47
SYNCHRO START.....	53
System Exclusive Messages.....	219
System Messages.....	219

T

Tempo (MDR).....	119
TEMPO (Rhythm).....	56
THRU (Effect).....	50
TIME (Slide).....	42
TO LOWER.....	26
TOP (Lead Voice).....	40
TOP (Shift End).....	88
TOUCH PANEL SOUND.....	16
TOUCH TONE.....	39
TOUCH VIBRATO.....	41
Transpose.....	193
TRANSPOSE (Voice section).....	42
TREMOLO/AUTO PAN.....	50
TUNE (Voice section).....	42
TUNE FINE (Voice Edit).....	136

U

U. ORGAN FLUTES.....	35
UD-FD01.....	224
Upper Keyboard Voice.....	22
UPPER KEYBOARD VOICE (Panel).....	8
USB flash memory.....	100
USB TO DEVICE.....	100, 210, 216
USB unit.....	210
USER (Registration Shift).....	87
USER (Vibrato).....	41
User button (Rhythm).....	58

User button (Voice).....	28
User Keyboard Percussion.....	70
User Rhythm.....	167
User Voice.....	141
UTILITY.....	15

V

VA (Voice Edit).....	139
VA Custom Voice.....	141
VA Voice.....	34
VARIATION (Rhythm Pattern Program).....	165
Version.....	21
VIBRATO.....	41
Voice.....	22
Voice button.....	23
Voice Condition.....	25, 39
VOICE DISPLAY.....	17
Voice Edit.....	131
VOICE EDIT (Panel).....	133
Voice Menu.....	24
Voice section.....	22
Volume (Accompaniment).....	62
Volume (Keyboard Percussion).....	66
VOLUME (MIC.).....	215
VOLUME (Organ Flutes).....	36
VOLUME (Rhythm Pattern Program).....	162
VOLUME (Rhythm).....	55
VOLUME (Voice).....	25

W

WAH.....	50
Wireless LAN.....	204

X

XG.....	6
---------	---

MEMO



MEMO



For details of products, please contact your nearest Yamaha representative or the authorized distributor listed below.

CENTRAL & SOUTH AMERICA

MEXICO

Yamaha de México S.A. de C.V.
Calz. Javier Rojo Gómez #1149,
Col. Guadalupe del Moral
C.P. 09300, México, D.F., México
Tel: 55-5804-0600

BRAZIL

Yamaha Musical do Brasil Ltda.
Rua Joaquim Floriano, 913 - 4º andar, Itaim Bibi,
CEP 04534-013 Sao Paulo, SP. BRAZIL
Tel: 011-3704-1377

ARGENTINA

**Yamaha Music Latin America, S.A.
Sucursal de Argentina**
Olga Cossetini 1553, Piso 4 Norte
Madero Este-C1107CEK
Buenos Aires, Argentina
Tel: 011-4119-7000

PANAMA AND OTHER LATIN AMERICAN COUNTRIES/ CARIBBEAN COUNTRIES

Yamaha Music Latin America, S.A.
Torre Banco General, Piso 7, Urbanización Marbella,
Calle 47 y Aquilino de la Guardia,
Ciudad de Panamá, Panamá
Tel: +507-269-5311

AFRICA

**Yamaha Corporation,
Asia-Pacific Music Marketing Group**
Nakazawa-cho 10-1, Naka-ku, Hamamatsu,
Japan 430-8650
Tel: +81-53-460-2312

MIDDLE EAST

TURKEY/CYPRUS

Yamaha Music Central Europe GmbH
Siemensstraße 22-34, 25462 Rellingen, Germany
Tel: 04101-3030

OTHER COUNTRIES

Yamaha Music Gulf FZE
LOB 16-513, P.O.Box 17328, Jubel Ali,
Dubai, United Arab Emirates
Tel: +971-4-881-5868

ASIA

THE PEOPLE'S REPUBLIC OF CHINA

Yamaha Music & Electronics (China) Co.,Ltd.
2F, Yunhedasha, 1818 Xinzha-lu, Jingan-qu,
Shanghai, China
Tel: 021-6247-2211

HONG KONG

Tom Lee Music Co., Ltd.
11/F., Silvercord Tower 1, 30 Canton Road,
Tsimshatsui, Kowloon, Hong Kong
Tel: 2737-7688

INDIA

Yamaha Music India Pvt. Ltd.
5F Ambience Corporate Tower Ambience Mall Complex
Ambience Island, NH-8, Gurgaon-122001, Haryana, India
Tel: 0124-466-5551

INDONESIA

**PT. Yamaha Music Indonesia (Distributor)
PT. Nusantik**
Gedung Yamaha Music Center, Jalan Jend. Gatot
Subroto Kav. 4, Jakarta 12930, Indonesia
Tel: 21-520-2577

KOREA

Yamaha Music Korea Ltd.
8F, 9F, Dongsung Bldg. 158-9 Samsung-Dong,
Kangnam-Gu, Seoul, Korea
Tel: 080-004-0022

MALAYSIA

Yamaha Music Malaysia, Sdn., Bhd.
Lot 8, Jalan Perbandaran, 47301 Kelana Jaya,
Petaling Jaya, Selangor, Malaysia
Tel: 3-78030900

PHILIPPINES

Yupangco Music Corporation
339 Gil J. Puyat Avenue, P.O. Box 885 MCPO,
Makati, Metro Manila, Philippines
Tel: 819-7551

SINGAPORE

Yamaha Music Asia Pte., Ltd.
#03-11 A-Z Building
140 Paya Lebor Road, Singapore 409015
Tel: 747-4374

TAIWAN

Yamaha KHS Music Co., Ltd.
3F, #6, Sec.2, Nan Jing E. Rd. Taipei.
Taiwan 104, R.O.C.
Tel: 02-2511-8688

THAILAND

Siam Music Yamaha Co., Ltd.
4, 6, 15 and 16th floor, Siam Motors Building,
891/1 Rama 1 Road, Wangmai,
Pathumwan, Bangkok 10330, Thailand
Tel: 02-215-2626

OTHER ASIAN COUNTRIES

**Yamaha Corporation,
Asia-Pacific Music Marketing Group**
Nakazawa-cho 10-1, Naka-ku, Hamamatsu,
Japan 430-8650
Tel: +81-53-460-2317

HEAD OFFICE Yamaha Corporation, Digital Musical Instruments Division
Nakazawa-cho 10-1, Naka-ku, Hamamatsu, Japan 430-8650
Tel: +81-53-460-3273



Yamaha Manual Library
<http://www.yamaha.co.jp/manual/>

U.R.G., Digital Musical Instruments Division
© 2004 – 2011 Yamaha Corporation
WR03710 109MWCP**E0
Printed in Japan