



DRUM TRIGGER MODULE

DTXPLODER

Owner's Manual



SPECIAL MESSAGE SECTION

This product utilizes batteries or an external power supply (adapter). DO NOT connect this product to any power supply or adapter other than one described in the manual, on the name plate, or specifically recommended by Yamaha.

WARNING: Do not place this product in a position where anyone could walk on, trip over, or roll anything over power or connecting cords of any kind. The use of an extension cord is not recommended! If you must use an extension cord, the minimum wire size for a 25' cord (or less) is 18 AWG. NOTE: The smaller the AWG number, the larger the current handling capacity. For longer extension cords, consult a local electrician.

This product should be used only with the components supplied or; a cart, rack, or stand that is recommended by Yamaha. If a cart, etc., is used, please observe all safety markings and instructions that accompany the accessory product.

SPECIFICATIONS SUBJECT TO CHANGE:

The information contained in this manual is believed to be correct at the time of printing. However, Yamaha reserves the right to change or modify any of the specifications without notice or obligation to update existing units.

This product, either alone or in combination with an amplifier and headphones or speaker/s, may be capable of producing sound levels that could cause permanent hearing loss. DO NOT operate for long periods of time at a high volume level or at a level that is uncomfortable. If you experience any hearing loss or ringing in the ears, you should consult an audiologist.

IMPORTANT: The louder the sound, the shorter the time period before damage occurs.

Some Yamaha products may have benches and / or accessory mounting fixtures that are either supplied with the product or as optional accessories. Some of these items are designed to be dealer assembled or installed. Please make sure that benches are stable and any optional fixtures (where applicable) are well secured BEFORE using.

NOTICE:

Service charges incurred due to a lack of knowledge relating to how a function or effect works (when the unit is operating as designed) are not covered by the manufacturer's warranty, and are therefore the owners responsibility. Please study this manual carefully and consult your dealer before requesting service.

ENVIRONMENTAL ISSUES:

Yamaha strives to produce products that are both user safe and environmentally friendly. We sincerely believe that our products and the production methods used to produce them, meet these goals. In keeping with both the letter and the spirit of the law, we want you to be aware of the following:

Battery Notice:

This product MAY contain a small non-rechargeable battery which (if applicable) is soldered in place. The average life span of this type of battery is approximately five years. When replacement becomes necessary, contact a qualified service representative to perform the replacement.

This product may also use "household" type batteries. Some of these may be rechargeable. Make sure that the battery being charged is a rechargeable type and that the charger is intended for the battery being charged.

When installing batteries, do not mix batteries with new, or with batteries of a different type. Batteries MUST be installed correctly. Mismatches or incorrect installation may result in overheating and battery case rupture.

Warning:

Do not attempt to disassemble, or incinerate any battery. Keep all batteries away from children. Dispose of used batteries promptly and as regulated by the laws in your area. Note: Check with any retailer of household type batteries in your area for battery disposal information.

Disposal Notice:

Should this product become damaged beyond repair, or for some reason its useful life is considered to be at an end, please observe all local, state, and federal regulations that relate to the disposal of products that contain lead, batteries, plastics, etc. If your dealer is unable to assist you, please contact Yamaha directly.

NAME PLATE LOCATION:

The name plate is located on the bottom of the product. The name plate lists the product's model number, power requirements, and other information. The serial number is located on the rear panel. Please record the model number, serial number, and date of purchase in the spaces provided below, and keep this manual as a permanent record of your purchase.

Model

Serial No.

Purchase Date

92-BP (others)

PLEASE KEEP THIS MANUAL

FCC INFORMATION (U.S.A.)

1. IMPORTANT NOTICE: DO NOT MODIFY THIS UNIT!

This product, when installed as indicated in the instructions contained in this manual, meets FCC requirements. Modifications not expressly approved by Yamaha may void your authority, granted by the FCC, to use the product.

2. IMPORTANT: When connecting this product to accessories and/or another product use only high quality shielded cables. Cable/s supplied with this product MUST be used. Follow all installation instructions. Failure to follow instructions could void your FCC authorization to use this product in the USA.

3. NOTE: This product has been tested and found to comply with the requirements listed in FCC Regulations, Part 15 for Class "B" digital devices. Compliance with these requirements provides a reasonable level of assurance that your use of this product in a residential environment will not result in harmful interference with other electronic devices. This equipment generates/uses radio frequencies and, if not installed and used according to the instructions found in the users manual, may cause interference harmful to the operation of other electronic devices. Compliance with FCC regulations does not guaran-

tee that interference will not occur in all installations. If this product is found to be the source of interference, which can be determined by turning the unit "OFF" and "ON", please try to eliminate the problem by using one of the following measures:

Relocate either this product or the device that is being affected by the interference.

Utilize power outlets that are on different branch (circuit breaker or fuse) circuits or install AC line filter/s.

In the case of radio or TV interference, relocate/reorient the antenna. If the antenna lead-in is 300 ohm ribbon lead, change the lead-in to co-axial type cable.

If these corrective measures do not produce satisfactory results, please contact the local retailer authorized to distribute this type of product. If you can not locate the appropriate retailer, please contact Yamaha Corporation of America, Electronic Service Division, 6600 Orangethorpe Ave, Buena Park, CA90620

The above statements apply ONLY to those products distributed by Yamaha Corporation of America or its subsidiaries.

* This applies only to products distributed by YAMAHA CORPORATION OF AMERICA.

(class B)

NEDERLAND / THE NETHERLANDS

- Dit apparaat bevat een lithium batterij voor geheugen back-up.
- This apparatus contains a lithium battery for memory back-up.
- Raadpleeg uw leverancier over de verwijdering van de batterij op het moment dat u het apparaat aan het einde van de levensduur afdankt of de volgende Yamaha Service Afdeling:

Yamaha Music Nederland Service Afdeling
Kanaalweg 18-G, 3526 KL UTRECHT
Tel. 030-2828425

- For the removal of the battery at the moment of the disposal at the end of the service life please consult your retailer or Yamaha Service Center as follows:

Yamaha Music Nederland Service Center
Address : Kanaalweg 18-G, 3526 KL UTRECHT
Tel : 030-2828425

- Gooi de batterij niet weg, maar lever hem in als KCA.
- Do not throw away the battery. Instead, hand it in as small chemical waste.

(lithium disposal)

ADVARESEL!

Lithiumbatteri—Eksplodingsfare ved fejlagtig håndtering. Udskitning må kun ske med batteri af samme fabrikat og type. Levér det brugte batteri tilbage til leverandøren.

VARNING

Explosionsfara vid felaktigt batteribyte. Använd samma batterityp eller en ekvivalent typ som rekommenderas av apparatillverkaren. Kassera använt batteri enligt fabrikantens instruktion.

VAROITUS

Paristo voi räjähtää, jos se on virheellisesti asennettu. Vaihda paristo ainoastaan laitevalmistajan suosittelemaan tyyppiin. Hävitä käytetty paristo valmistajan ohjeiden mukaisesti.

(lithium caution)

Caution

Use ONLY a Yamaha PA-3C AC Power Adaptor (or other adaptor specifically recommended by Yamaha) to power your instrument from the AC mains. The use of other adaptors may result in irreparable damage to both the adaptor and the instrument.

PRECAUTIONS

PLEASE READ CAREFULLY BEFORE PROCEEDING

* Please keep this manual in a safe place for future reference.

WARNING

Always follow the basic precautions listed below to avoid the possibility of serious injury or even death from electrical shock, short-circuiting, damages, fire or other hazards. These precautions include, but are not limited to, the following:

Power supply/AC power adaptor

- Only use the voltage specified as correct for the instrument. The required voltage is printed on the name plate of the instrument.
- Use the specified adaptor (PA-3C or an equivalent recommended by Yamaha) only. Using the wrong adaptor can result in damage to the instrument or overheating.
- Check the electric plug periodically and remove any dirt or dust which may have accumulated on it.
- Do not place the AC adaptor cord near heat sources such as heaters or radiators, and do not excessively bend or otherwise damage the cord, place heavy objects on it, or place it in a position where anyone could walk on, trip over, or roll anything over it.

Do not open

- Do not open the instrument or attempt to disassemble the internal parts or modify them in any way. The instrument contains no user-serviceable parts. If it should appear to be malfunctioning, discontinue use immediately and have it inspected by qualified Yamaha service personnel.

CAUTION

Always follow the basic precautions listed below to avoid the possibility of physical injury to you or others, or damage to the instrument or other property. These precautions include, but are not limited to, the following:

Power supply/AC power adaptor

- When removing the electric plug from the instrument or an outlet, always hold the plug itself and not the cord.
- Unplug the AC power adaptor when not using the instrument, or during electrical storms.
- Do not connect the instrument to an electrical outlet using a multiple-connector. Doing so can result in lower sound quality, or possibly cause overheating in the outlet.

Location

- Do not expose the instrument to excessive dust or vibrations, or extreme cold or heat (such as in direct sunlight, near a heater, or in a car during the day) to prevent the possibility of panel disfiguration or damage to the internal components.
- Do not use the instrument in the vicinity of a TV, radio, stereo equipment, mobile phone, or other electric devices. Otherwise, the instrument, TV, or radio may generate noise.
- Do not place the instrument in an unstable position where it might accidentally fall over.
- Before moving the instrument, remove all connected adaptor and other cables.
- Use only the stand/rack specified for the instrument. When attaching the stand or rack, use the provided screws only. Failure to do so could cause damage to the internal components or result in the instrument falling over.

Connections

- Before connecting the instrument to other electronic components, turn off the power for all components. Before turning the power on or off for all components, set all volume levels to minimum. Also, be sure to set the volumes of all components at their minimum levels and gradually raise the volume controls while playing the instrument to set the desired listening level.

Water warning

- Do not expose the instrument to rain, use it near water or in damp or wet conditions, or place containers on it containing liquids which might spill into any openings.
- Never insert or remove an electric plug with wet hands.

Fire warning

- Do not put burning items, such as candles, on the unit. A burning item may fall over and cause a fire.

If you notice any abnormality

- If the AC adaptor cord or plug becomes frayed or damaged, or if there is a sudden loss of sound during use of the instrument, or if any unusual smells or smoke should appear to be caused by it, immediately turn off the power switch, disconnect the adaptor plug from the outlet, and have the instrument inspected by qualified Yamaha service personnel.

Maintenance

- When cleaning the instrument, use a soft, dry cloth. Do not use paint thinners, solvents, cleaning fluids, or chemical-impregnated wiping cloths.

Handling caution

- Do not place vinyl, plastic or rubber objects on the instrument, since this might discolor the panel or keyboard.
- Do not rest your weight on, or place heavy objects on the instrument, and do not use excessive force on the buttons, switches or connectors.
- Do not operate the instrument for a long period of time at a high or uncomfortable volume level, since this can cause permanent hearing loss. If you experience any hearing loss or ringing in the ears, consult a physician.

Backup battery

- This instrument has a built-in lithium backup battery. When you unplug the power cord from the AC outlet, the internal data is retained. However, if the backup battery fully discharges, this data will be lost. When the backup battery is running low, the display indicates "Battery Low." In this case, immediately memo the data settings, then have qualified Yamaha service personnel replace the backup battery.

Yamaha cannot be held responsible for damage caused by improper use or modifications to the instrument, or data that is lost or destroyed.

Always turn the power off when the instrument is not in use.

Even when the power switch is in the "STANDBY" position, electricity is still flowing to the instrument at the minimum level. When you are not using the instrument for a long time, make sure you unplug the AC power adaptor from the wall AC outlet.

Make sure to discard used batteries according to local regulations.

Thank you for purchasing the Yamaha DTXPLOLER.

The DTXPLOLER is a compact drum trigger module that includes a wealth of rich, high-quality drum voices, a multi-function metronome, and song play function.

To get the most out of the DTXPLOLER, please read this manual thoroughly. After reading the manual, keep it in a safe place for future reference.

About the descriptions

This manual describes buttons and explanations using the following rules.

- [DRUM KIT], [CLICK], etc. The button on the top panel is indicated with []. (brackets).
- [SHIFT]+[DRUM KIT], etc. Means hold the [SHIFT] button and press the [DRUM KIT] button.
- [◀]/[▶], etc. Means use the [◀] button or [▶] button.
- “Completed!”, etc. Words inside “ ” indicate the message shown on the display.
- → P. 12, etc. Indicates the reference page where further information can be found.

NOTE

The illustrations and LCD screens as shown in this owner's manual are for instructional purposes only, and may appear somewhat different from those on your instrument.

Inside this package

This package contains the following items. After opening the package, please check and makes sure that all the items In the list are present.

- **The DTXPLOLER**
- **Power Adaptor ***
- **Owner's Manual (this book)**

* May not be included depending on your particular area. Please check with your Yamaha dealer.

The DTXPLOTORER's Main Features

The DTXPLOTORER is equipped with a high-quality 32-polyphony tone generator that produces realistic voices, a high-performance metronome, and a variety of songs, all built into a compact design.

The DTXPLOTORER is a versatile instrument that can be used in a variety of situations such as live performance, personal practice, and much more.

■ Drum Trigger Function

- Built into the unit are nine trigger input jacks and a hi-hat controller jack. Jacks that are compatible with rim switch and 3-zone trigger equipped pads are also supplied. In addition to trigger pad compatibility, the unit can also be used with devices such as Yamaha's DT20 Drum Triggers, etc.
- Setup data such as pad trigger input type, sensitivity settings, etc., are stored in four preset patterns. This lets you simply choose the system that meets your playing needs. The unit also provides a pattern for user memory in which you can create and store your own custom settings for pads or drum triggers.
- Also included in the unit are 32 preset drum kits. Acoustic drum kit types cover a range of genres from rock, funk, jazz, reggae, Latin percussion, etc. and are readily available for use. There are also 10 user memory kits in which you can freely mix, match and edit a variety of drum/percussion voices to create your own original drum kits.

■ Tone Generator

- The DTXPLOTORER is equipped with a high-quality, 16-bit AWM2 (PCM) tone generator with 32 voice polyphony.
- Voices include 192 drum and percussion voices. Voices cover a wide range of sounds such as highly realistic acoustic sounds, unique electronic percussion sounds, effect sounds, and much more.
- Also featured is the same internal digital reverb section that is found in Yamaha's MU series of GM/XG compatible tone generators.

■ High Performance Metronome

- The sound for each note value is adjustable. Each note value can be assigned its own separate click voice and pitch. You can also set a timer that will determine when the metronome stops and set breaks which how many measures the metronome will play and then be muted.
- The DTXPLOTORER also features a "Tap" function that lets you set the tempo for the metronome or song by tapping in tempo on a pad to any tempo you like.

■ Preset Songs

- The sequencer contains 22 preset songs (two demo songs plus 20 pattern songs). Two functions that make the DTXPLOTORER great for practice are the Bass Solo Function—which lets you play along with the song's bass part only—and the Drum Mute Function—which mutes a specific drum part.

■ Groove Check Function

- The Groove Check Function is a great training aid that will let you know how accurate your playing is and check your consistency in dynamics (output level). This function is an excellent aid for those who want to increase their precision in playing.

■ Interface

- A MIDI OUT jack on the rear panel lets you play sounds from an external tone generator or synchronize the metronome with an external sequencer.
- An AUX IN (Auxiliary In) jack lets you plug in an external audio device such as a CD player, MD player, etc., and play along.
- A headphones jack is also included.

CONTENTS

Nomenclature	7
Top Panel	7
Rear Panel	8
Connections	9
Connecting the DTXPLORER's pads to the main unit	9
Using the DTXPLORER with an Acoustic Drum Kit	9
■ Connecting to Speakers or Headphones	10
■ Connecting the Power Supply	11
Time to Play	12
Adjusting the Hi-Hat	13
Play Along With The Metronome	14
Click Out Select	16
Play Along With a Song!	17
Tap Tempo Function	18
Using the Groove Check Function	19
Create Your Own Original Drum Kit	20
Factory Set	23
Trigger Setup Edit	24
Selecting the Trigger Setup	24
Editing the Trigger Setup	24
Error Messages	28
Trouble Shooting	28
Specifications	30
MIDI Data Format	31
MIDI Transmit Note Number	31
Display Global View	32
MIDI Implementation Chart	34
Drum Voice List	35
Preset Drum Kit List	35
Preset Song List	35

Nomenclature

Top Panel

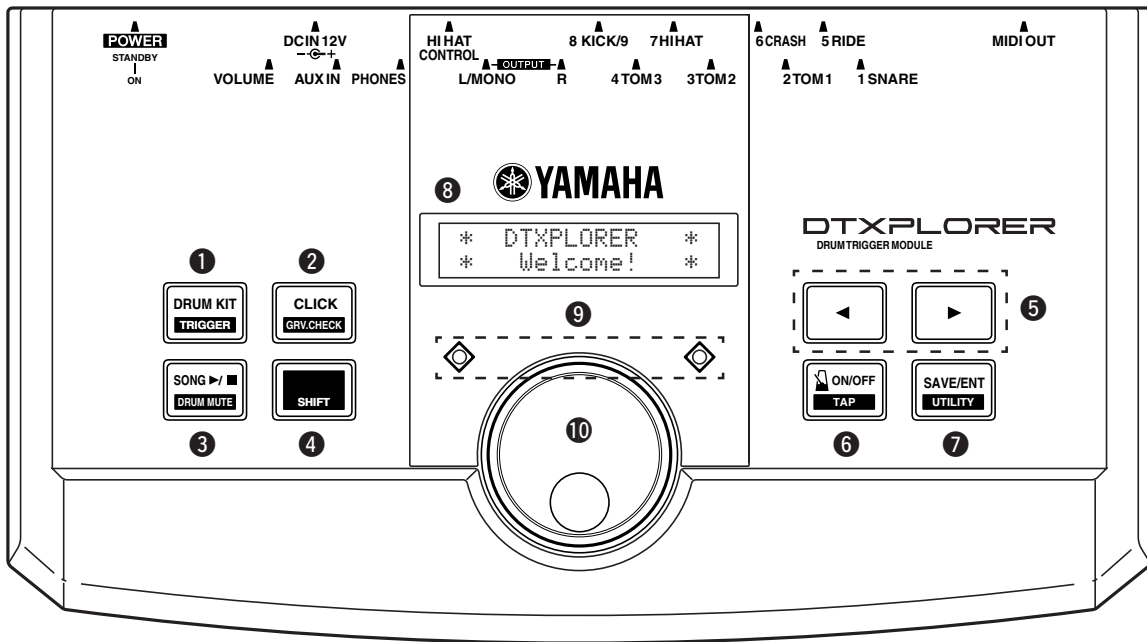

1 Drum Kit Button (DRUM KIT)

- This button is used to enter the Drum Kit Select display. (P. 12)
- Hold the [SHIFT] button and press the [DRUM KIT] button to enter the Trigger Setup Select display (P. 24)
- Stops production of any voices being produced.

2 Click Button (CLICK)

- This button is used to enter the Click (Metronome) Setting display. (P. 14)
- Hold the [SHIFT] button and press the [CLICK] button to enter the Groove Check Setting display. (P. 19)

3 Song Button (SONG >/■)

- This button is used to enter the Song Select display. (P. 17)
- Hold the [SHIFT] button and press the [SONG >/■] button to mute only the drum part during playback. (Drum Mute Function)
- Press this button to start/stop song playback.

4 Shift Button (SHIFT)

Hold this button to access the secondary function of another button.

5 Select Buttons (<, >)

- These buttons are used to select (the selected item flashes) an item you want to edit. If there are multiple pages, either before or after the page currently displayed, the buttons are used to view the next or previous page. Hold the button to continuously move the flashing cursor.
- Hold the [SHIFT] button and press the [<|/|>] buttons to select the select item you want to edit when a page that allows editing is open.

6 Metronome ON/OFF Button (ON/OFF)

- This button is used to Start/Stop metronome playback (click sound). (P. 14)
- Hold the [SHIFT] button and press the [ON/OFF] button to enter the Tap Tempo Setting display. (P. 18)

7 Save/Enter Button (SAVE/ENT)

- This button is used to carry out the command (Enter), or save data.
- Hold the [SHIFT] button and press the [SAVE/ENT] button to enter the Utility Mode, which is used to make overall settings for operating the DTXPLOORER.
- In the Song display, this button is used to start/stop song playback.

8 LCD Display

Shows information or data that is needed to operate the DTXPLOORER.

9 Click Lamp

The red lamp lights on the first beat of every measure when the metronome or a song is playing. The other beats are indicated with a green light.

10 Jog Dial

Rotate the jog dial to change the value selected with the flashing cursor (the item being edited) in the display. Rotate the dial to the right (clockwise) to increase the value, and to the left to decrease. Hold the [SHIFT] button and rotate the Jog Dial to increase/decrease the value by 10.

Rear Panel

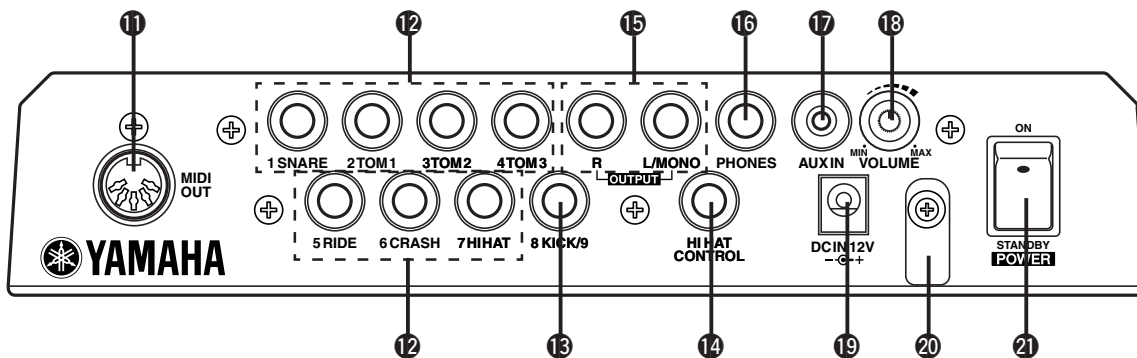

11 MIDI OUT Jack

This jack is used to send data from the DTXP1000 to an external MIDI device.

With this jack, you can use the DTXP1000 as a control device to trigger voices from an external tone generator, or synchronize the DTXP1000's song or metronome playback with the playback of an external sequencer. (P. 11)

12 Trigger Input Jacks (1 SNARE thru 7 HI HAT)

These jacks are used to connect the pads or trigger sensors to the main unit. Connect pads such as snare, tom, etc., according to the indication below each input. (P. 9)

- 3-zone jack 1 SNARE jack
- Stereo (w/switch) jacks 5 RIDE, 6 CRASH jacks
- Monaural jacks 2 TOM1, 3 TOM2, 4 TOM3, 7 HI HAT jacks

13 Trigger Input jack (8 KICK/9)

This jack is used to connect the kick pad to the main unit. Using the supplied stereo cable to connect the KP65 kick pad to the main unit allows the connection of an additional pad to Input jack 9 via the external pad input jack on the KP65.

14 Hi-Hat Controller Jack (HI HAT CONTROL)

This jack is used to connect a hi-hat controller. (P. 9)

* Use a cable with a stereo plug (shown below) when connecting a Hi-hat controller.

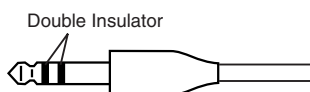

15 Output Jacks (OUTPUT L/MONO, R)

These jacks are used to connect the DTXP1000 to an external amplifier, mixer, etc. For monaural playback use the L/MONO jack. For stereo playback connect both L/R jacks.

16 Head Phone Jack (PHONES)

Connect a pair of headphones to this jack to monitor the DTXP1000. (P. 10)

17 AUX IN Jack

Connect the output of an external audio device, etc., to this jack (stereo mini jack). (P. 10)

This is convenient for playing along with music from a CD or cassette player.

* Use the volume control on the external device (CD, cassette player, etc.) to adjust the volume balance.

18 Master Volume (VOLUME)

Adjusts the DTXP1000's overall volume (output level of the signal delivered by the OUTPUT jacks and PHONE jack).

Rotate the knob clockwise to increase volume, and counter-clockwise to decrease.

19 Power Supply Jack (DC IN 12V)

Connect an AC adaptor to this jack. To prevent the adaptor from becoming unplugged, secure the cord to the cord hook 20.

20 Cord Hook

Prevents the power cord from accidentally becoming unplugged. (P. 11)

21 Power Switch (POWER)

This is the DTXP1000's power switch.

Connections

CAUTION

To prevent electric shock and damage to the devices, make sure the power is switched OFF on the DTXPLOTORER and all related devices before making any connections to the DTXPLOTORER's input and output jacks.

Connecting the DTXPLOTORER's pads to the main unit

Refer to the illustration below and connect each pad's output cable to each Trigger Input jack on the rear panel of the DTXPLOTORER. All Trigger Input Jacks are labeled (1 SNARE, etc.) so make sure each pad is connected to its corresponding Trigger Input jack.

* The DTXPLOTORER's settings will provide optimum performance when pads (1 SNARE, etc.) are connected to their corresponding Trigger Input jacks, however, if other pads or drum triggers that have different operating characteristics are connected to the jacks, settings for sensitivity, etc., as described in the "Trigger Setup Edit" section (P. 24) should be changed.

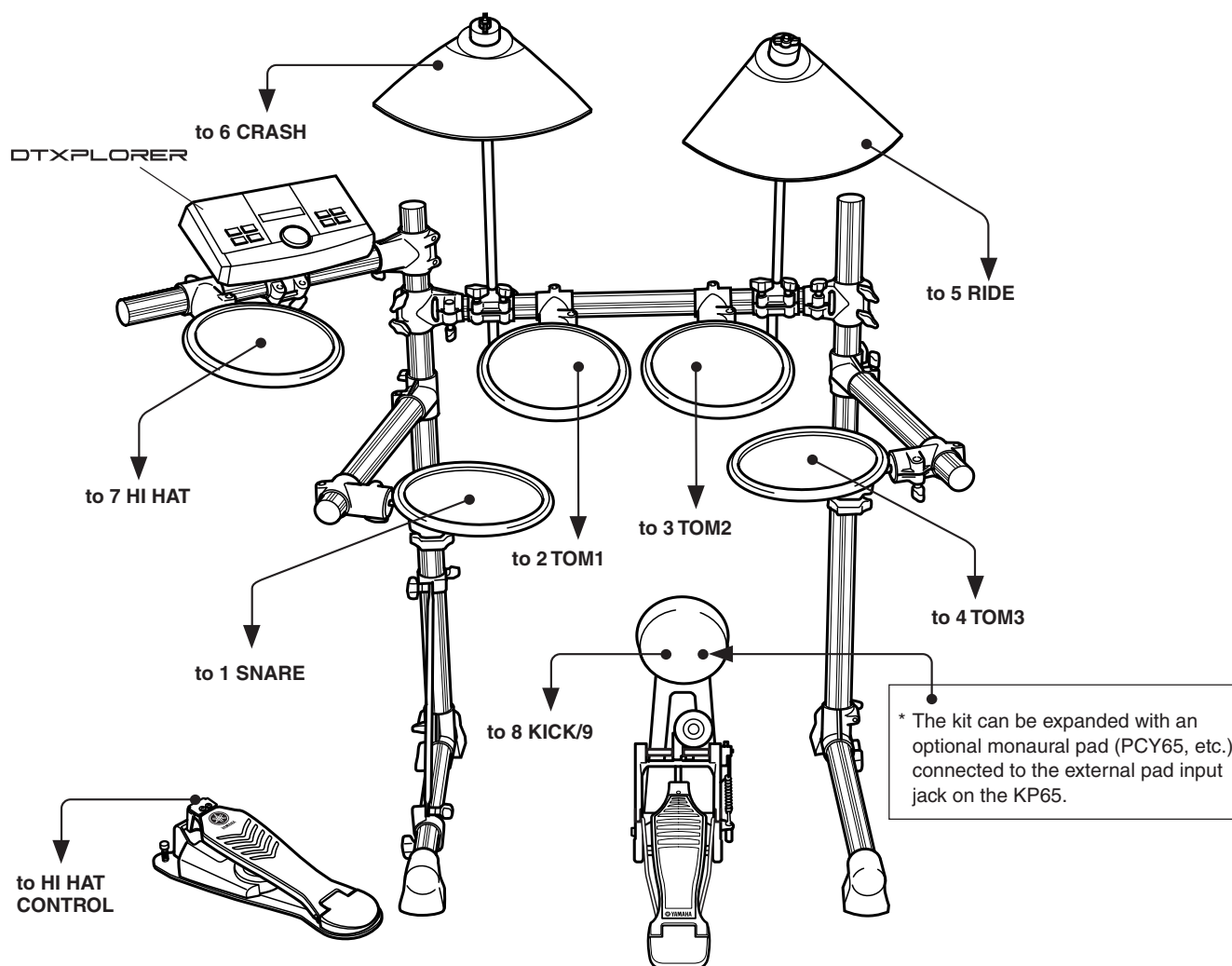

Using the DTXPLOTORER with an Acoustic Drum Kit

The DTXPLOTORER can be played from an acoustic drum kit if the kit is fitted with an optional set of Yamaha DX20 Drum Triggers and the triggers are connected to the DTXPLOTORER's input jacks.

* After making connections, make sure settings in the DTXPLOTORER's trigger setup (P. 24) are properly adjusted.

Connections

● Some Advice On Connections

- Trigger Input jacks 5 RIDE and 6 CRASH are stereo input type jacks. These jacks can be connected to switch equipped pads such as the TP65S, PCY65S, PCY130S, etc.
- 3-Zone pads like the TP65S, PCY150S, etc., can be connected to Trigger Input jack 1 SNARE.
- Pad sensitivity is set in the Trigger Setup Edit's [TRIG2 Type (Pad type)] setting (P. 25).
- Using the supplied stereo cable to connect the KP65 kick pad to the main unit allows the connection of an additional pad to Input jack 9 via the external pad input jack on the KP65.

■ Connecting to Speakers or Headphones

The DTXPLOTTER is not equipped with built-in speakers. The unit must be connected to an external amp + speaker system or headphones for sound output.

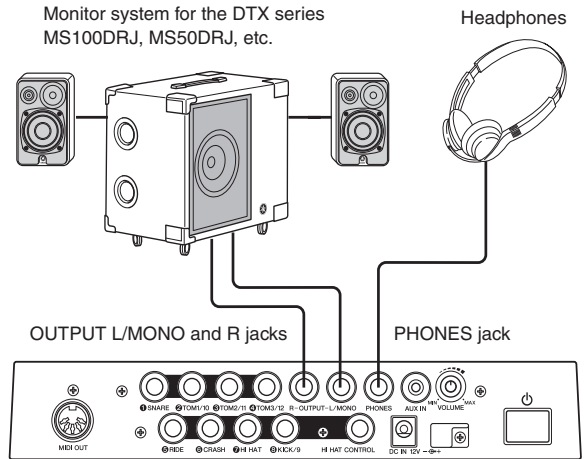

CAUTION

Whenever making connections, make sure that the cable being used is equipped with a plug that corresponds to the jack type on the specific device.

● OUTPUT L/MONO, R Jack (Monaural Standard Phone Jack)

With these jacks you can connect the DTXPLOTTER to a mixer or audio equipment to produce sound from external speakers, or connect the DTXPLOTTER to audio recording equipment for recording your own performance.

- * Use the DTXPLOTTER's OUTPUT L/MONO jack when connecting to a device with a monaural input.

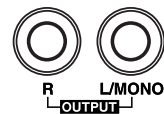

● PHONES Jack (Standard Stereo Phone Jack)

Use the VOLUME knob on the rear panel to adjust headphone volume.

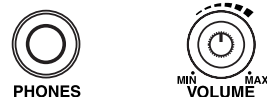

Whenever using headphones, take care not to damage your hearing. Use the equipment with the volume adjusted to a comfortable level.

● AUX IN Jack (Stereo Mini Phone Jack)

You can connect the audio outputs from a CD player, or other external audio source, to the AUX IN jack to mix the signal from the external source with the signal from the DTXPLOTORER. The combined audio can be sent on to an external device via the DTXPLOTORER's output jacks. This jack can be used when you want to play along with a favorite tune or perform with friends.



AUX IN

Use the volume control on the external device (CD player, etc.) to adjust the volume balance.

● MIDI OUT Jack

The DTXPLOTORER's MIDI function lets you play voices on an external tone generator with the DTXPLOTORER's pads, or synchronize the DTXPLOTORER's song or metronome playback with the playback of an external sequencer.

About MIDI

MIDI (Musical Instrument Digital Interface) is a world standard that provides a means to connect instruments and computers and allow them to transmit and receive performance and other data. This standard allows computers and instruments of different makers and types to communicate.



MIDI OUT

Always use a standard MIDI cable when connecting devices. Also, use a MIDI cable that is not more than 15m in length. Using a longer cable may result in irregular operation and other problems.

■ Connecting the Power Supply

A special power source adaptor supplies power to the DTXPLOTORER.

Make sure the power is switched OFF and connect the power adaptor to the DC IN jack on the rear panel.

To prevent the cord from becoming unplugged, wrap the cord around the cord hook and secure.

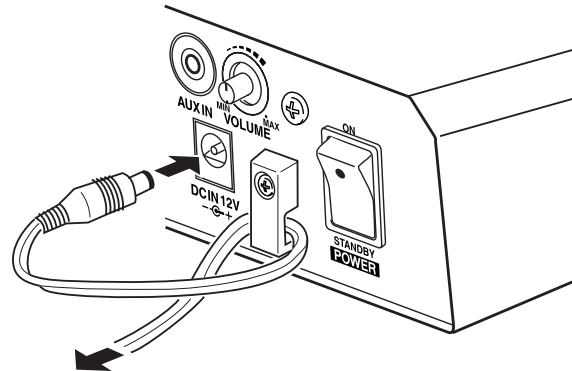

WARNING

Make sure that the power adaptor's cord is not bent at an acute angle when wrapping the cord onto the hook. Such a situation can result in a damaged power cord or fire.

CAUTION

Use ONLY a Yamaha PA-3C AC Power Adaptor (or other adaptor specifically recommended by Yamaha). The use of other adaptors may result in irreparable damage to both the adaptor and the instrument. Also, when the DTXPLOTORER is not to be used for a long period of time, please unplug the power adaptor.

Before switching the power ON.

- To protect the speakers, headphones and the DTXPLOTORER from damage, fully rotate the POWER/VOL knob to the left (minimum volume) before switching the power ON.
- Make sure the power is switched OFF on all external devices connected to the DTXPLOTORER. After the DTXPLOTORER's power is switched ON, switch the other device's power ON.

Time to Play

Now that your DTXPLOTTER is properly connected, it's time to make some music!

1. Switch the power ON

After confirming that all devices, pads, external devices, etc., are properly connected, press the POWER switch located on the rear panel to switch the power ON.

After purchasing the DTXPLOTTER, the following message will appear in the display the first time you switch the power on.



After hitting a pad several times, switch the power off and then on again, and the total number times the pads have been hit is shown in the display (Hit Counter Function).

- * The Hit Counter is reset to "0" after carrying out the factory set. (P.23)

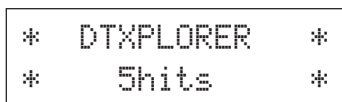

When the Drum Kit Select display (shown below) appears, the DTXPLOTTER is ready to be played.

- * The most recently used drum kit is selected in the display.
- * Press the [DRUM KIT] button if another display is shown.

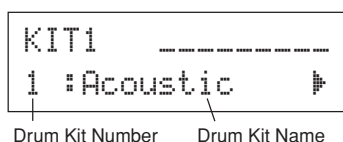
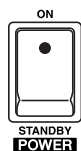

CAUTION
To avoid damage to your speakers, first switch the DTXPLOTTER's power ON then switch on Audio Devices and the Mixer or Amplifier.

2. Play the DTXPLOTTER

While hitting on the pads, rotate the volume knob on the rear panel to the right to increase the overall volume to a comfortable volume level.

Rotating the knob to the right increases the volume level while rotating to the left decreases.



3. Select A Drum Kit

Each kit is made up of voices that are produced when a pad is hit. Drum kit numbers 1 through 32 consist of 32 different types of preset drum kits that have been specially programmed by Yamaha sound designers.

Rotate the jog dial to select a drum kit.

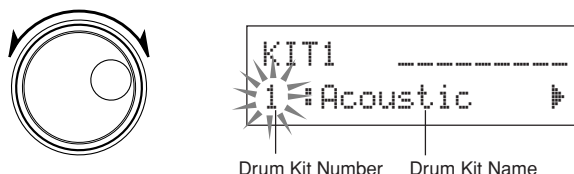

Try out some of the different drum kits and select a kit you'd like to use.

4. Change the Output Sound Quality

Use the [Master Equalizer] display found on page 4 in the Utility Mode to change the output sound quality. Overall settings for the DTXPLOTTER are set in the Utility Mode.

First, press the [SHIFT] + [SAVE/ENT] buttons to enter page 1 in the Utility Mode.

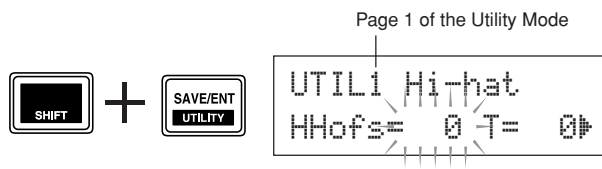

The "HHofs=" value is flashing. Press the [▶] button once to move the flashing cursor to the "T=" value position.

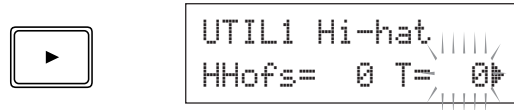

Press the [▶] button again to go to page 2 in the Utility Mode. The "OutSel=" value is flashing.

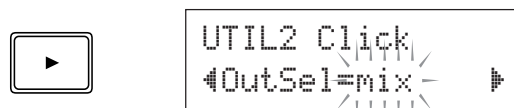

Press the [▶] button twice to go to page 4 in the Utility Mode.



Use the [◀]/[▶] buttons in this manner to select (the flashing cursor) the item you want to set. When the page only contains a single item, pressing the [◀]/[▶] buttons will select the next or previous page.

* The “▶” mark on the lower right side of the display indicates that a succeeding page exists. Likewise, the “◀” mark on the lower left side of the display indicates a previous page exists.

Now use the Master Equalizer (2-band shelving type) setting to change the sound quality.

The “Lo=” value is flashing. To increase low frequency emphasis, rotate the jog dial to adjust the value (low frequency gain: +0dB to +12dB).

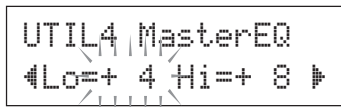
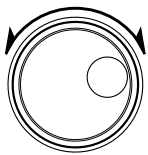

Similarly, press the [▶] button to flash the “Hi=” value, then rotate the jog dial to adjust the high frequency gain (+0dB to +12dB).

You can also adjust or set the individual pad voices, volume, tuning, reverb type/level, and other settings that fine-tune the DTXPLORER. (P. 20)

Adjusting the Hi-Hat

Hi-hat adjustment is used to determine the point at which the hi-hat closes when the hi-hat pedal (foot controller) is pressed.

You can also set the ease at which foot splashes are produced.

* This setting is only valid when a foot controller is connected to the HI HAT CONTROL jack. The setting has no effect on a foot controller connected to any other jack.

Procedure

1. Press the [SHIFT] + [SAVE/ENT] buttons to view the following page (page 1 in the Utility Mode). Use this display to adjust the hi-hat.

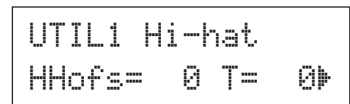

2. To set the point at which the hi-hat closes, flash the “HHofs=” value then use the jog dial to adjust the value.

The setting has a range of -32 to 0 to +32. Smaller values produce a shallower closing point.

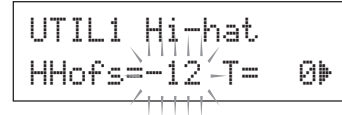

To set the ease at which foot splashes are produced, flash the “T=” value then use the jog dial to adjust the value.

The setting has a range of 0 to 127. Larger values make foot splashes that are long and easier to produce.

* Too high a value will makes foot splashes too easy to produce, resulting in the continuous production of foot splashes when the pedal is held down continuously.

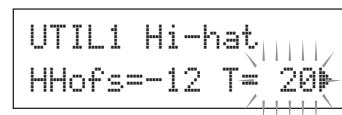

Play Along With The Metronome

Start the metronome and play along on the DTXPLORER's pads.

The DTXPLORER is equipped with a high performance metronome that lets you create complex rhythms.

1. Start the Metronome

Press the [ON/OFF] button to start the metronome.

The red lamp lights on the first beat of every measure when the metronome is playing. Other beats are indicated with the green lamp.

Press the [ON/OFF] button again to stop the metronome.

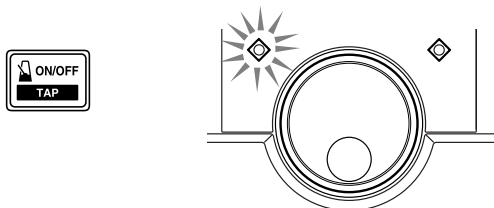

2. Set the settings for Click Set, Tempo, Beat, etc.

By fine tuning the different note value clicks that are shown in the illustration below, the DTXPLORER's metronome can be used to create a variety of click patterns. The patterns you set are called Click Sets, and you can save up to 30 original patterns in the DTXPLORER's memory.

Example) Beat timings used when Beat=4

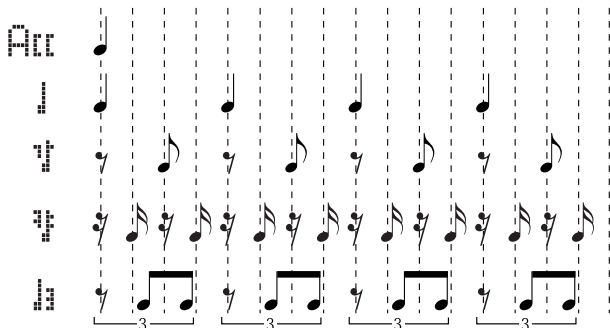

First, select a click set from one of the presets and listen.
Press the [CLICK] button to view page 1 in the Click Setting.

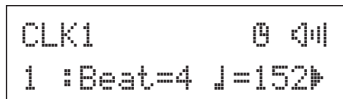

Use this display to select the click set and then set the beat, tempo, timer, and the click sound's overall volume.

Press the [◀]/[▶] buttons to move the flashing cursor to the item you want to set, then rotate the jog dial to set its value.

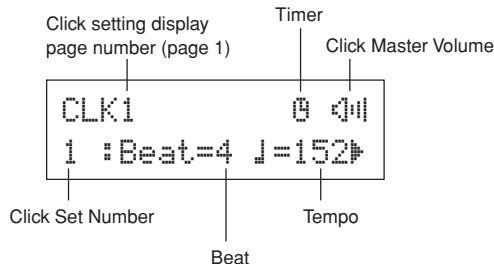

- **Click Set Number** [Range: 1 to 30]
Selects the click set to be used.
 - **Beat** [Range: 1 to 9]
Sets the click's time signature.
 - **Tempo** [Range: 30 to 300]
Sets the click's tempo (♩=).
- HINT** The Tap Tempo Function can be used to set the tempo. In this function, hitting the pads in tempo sets the song or click's tempo. This let's you set the tempo to any tempo you like. Refer to page 18 for more information.
- **Timer** [Range: off, 30 to 600 seconds]
This function is used to automatically stop the metronome at the time set in this setting.
 - **Click Master Volume** [Range: 0 to 16]
Sets the click's overall volume.
- * When the flashing cursor is not positioned here, the speaker icon will be displayed.

Important!

An asterisk "*" will appear next to "CLK1" in the display if the beat or tempo setting is changed. This is to let you know that data has been changed. This mark will disappear after the Store Operation (P. 16) is carried out to save data in the DTXPLORER's memory. If a different click set is selected before carrying out the Store Operation, the current settings will return to their original condition. If you want to keep changes made to the data, make sure you carry out the Store Operation.

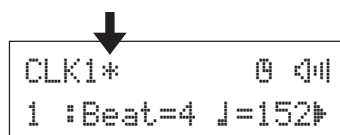

3. Create Your Own Original Click Set

Press the [▶] button to view page 2 in the Click Setting.

```
CLK2 Att=9 I=9
◀ V=6 W=4 J=2 ▶
```

Use this display to set the individual volume levels (0 to 9) for each of the five click beats. Set the volume level to “0” if you don’t want the beat to be produced. Use this page to create your own original click set.

4. Set the Click Measure Break

Press the [▶] button to view the [Click Measure Break] section on page 3 in the Click Setting.

```
CLK3 MeasBreak
◀ Meas=1 Brk=3 ▶
```

The Click Measure Break puts a muted “break” for the number of measures decided with the “Brk” setting (off, 1 to 9) after the metronome has played for the number of measures determined by the “Meas” setting (1 to 9).
 * If the setting “Brk=off” is used, the metronome will not be muted.

5. Set the Click Voice Set

Press the [▶] button to view the [Click Voice Set] section on page 4 in the Click Setting.

```
CLK4 Sound
◀ 1:Metronome ▶
```

The Click Voice Set is used to assign the 5 different click sounds that are produced by the metronome. The sounds are changed as a group.

Range: Metronome, Wood Block, Percussion, AgoGo, Stick, Pulse, UserClick

With the “UserClick” setting you can use the CLK5 and CLK6 pages to fine-tune the metronome’s click voice settings.

6. Set the Click Voices

Press the [▶] button to view the [Click Voice] section on page 5 in the Click Setting.

```
Click Value Type
CLK5 Sound= J
◀ K/001 Maple 22 ▶
Voice Category/Voice Number Voice Name
```

You can assign a different drum voice to each of the metronome’s five click voices.

* This setting is not available if the setting for CLK4 is set to anything other than “UserClick”.

First, select the click value type (Att, I, V, W, J) in the upper half of the display, then move the flashing cursor to the lower half of the display and select the voice you want to assign to the click.

First, select the voice category.

● Voice Category

- K: Kick
- S: Snare
- T: Tom
- C: Cymbal
- H: Hi-hat
- P: Percussion
- E: Effect

Next, select the voice number (0, 1 to 127)/voice name. If the voice number is set to “0”, “NoAssign” is assigned to the voice name and no sound will be produced.

7. Set the Click Voice’s Tuning

Press the [▶] button to view the [Click Tuning] section on page 6 in the Click Setting.

```
Click Value Type
CLK6 Sound= J
◀ Tune=+12.0 ▶
Tuning
```

You can individually tune each of the five click sounds in increments of 10-cents.

* This setting is not available if the setting for CLK4 is set to anything other than “UserClick”.

First, select the click voice type (Att, I, V, W, J) in the upper half of the display, and then move the flashing cursor to the lower half of the display and set the tuning (-24 to 0 to +24).

Play Along With The Metronome

8. Save an Original Click Set

After creating your own original click set, save it in the DTXPLORER's memory using the Store Operation described below.

* Any changes made to the data will be lost if another click set is selected before carrying out the store operation.

8-1. Press the [SAVE/ENT] button. The following display will appear.

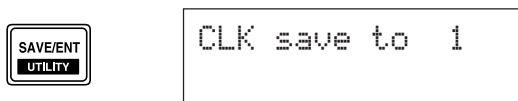

8-2. Rotate the jog dial to select the destination memory number (1 to 30) that you want to store the click set in.

8-3. Press the [SAVE/ENT] button again and the following display asking your confirmation to proceed with the store operation.

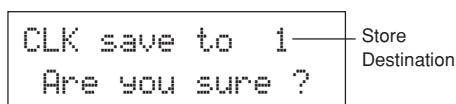

8-4. Press the [SAVE/ENT] button to carry out the store operation.

* To cancel the store operation, press any button except for the [SAVE/ENT] and [SHIFT] buttons (when "Are you sure?" appears in the display, the jog dial will also cancel the operation).

The following display appears after the store operation is complete.

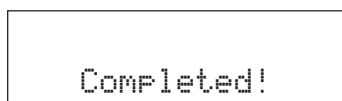

HINT You can use the "Factory Set" operation to reset the contents of click sets 1 through 30 to their original factory condition.

However, please proceed with caution because carrying out this operation will rewrite the DTXPLORER's entire contents (all click sets, user trigger setup (No. 5), user drum kits 33 to 42) with the data that was set in the unit's memory when it was shipped from the factory. (P. 23)

Click Out Select

The DTXPLORER lets you select from which output jack the metronome's signal is delivered. Click output and performance output can be routed to separate outputs.

Procedure

1. Press the [SHIFT] + [SAVE/ENT] buttons and the following display will appear. (Page 1 in the Utility Mode.)

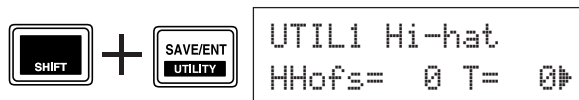

2. Next, press the [▶] button twice so that the following display appears.

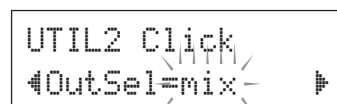

3. Rotate the jog dial to select the output from the outputs listed below.

mix: This is the standard output setting. The click signal is delivered from both the OUTPUT L and R jacks.

clickL: The click signal is delivered from the OUTPUT L jack only. All drum performance and song playback is delivered in monaural via the OUTPUT R jack.

clickR: The click signal is delivered from the OUTPUT R jack only. All drum performance and song playback is delivered in monaural via the OUTPUT L jack.

* The PHONES jack delivers the same signal as the OUTPUT jacks. The settings in this section would then be applied to the PHONES jack's stereo L and R.

Play Along With a Song!

The DTXPLORER's built-in sequencer contains data for 22 songs that, in addition to drums, include accompaniment with keyboard, brass, and other voices. Try playing along with a song!

1. Select a Song

Select one of the DTXPLORER's songs and listen.

Press the [SONG ▶/■] button to view the Song Select display.

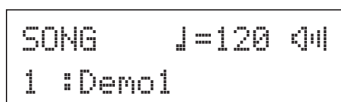

Use the [◀]/[▶] buttons to flash the song number, then use the jog dial to select the song number (1 to 22) you want to listen to.

- * The drum kit will change to one that matches the selected song when a different song is selected.

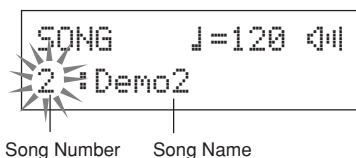
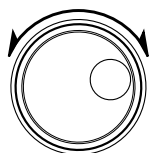

Song Number Song Name

2. Listen to the Song

Press the [SONG ▶/■] button and after the count, the song will start playback from the beginning.

After the song has played to the end, it will automatically start playing from the beginning again.

Press the [SONG ▶/■] button to stop playback.



- * To return the setting to its original tempo or voice, reselect the song.
- * If a different song is selected during song playback, the new song will start playback from the beginning.

3. Adjust the Song's Volume and Tempo

Use the [◀]/[▶] buttons to flash the tempo value, and then use the jog dial to set the song's playback tempo (♩=30 to 300).

Next, press the [▶] button to move the flashing cursor to the right. The speaker icon will change to a numeric value and flash. This sets the volume for the parts other than the drum (0 to 16). Rotate the jog dial and adjust the balance between the song accompaniment and your performance.

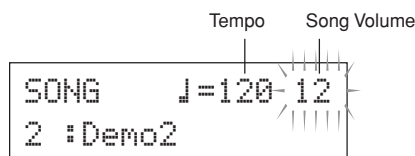

- HINT** The tempo can also be set using the Tap Tempo Function. This function lets you set the song or metronome's tempo by tapping in tempo on a pad. With this, you can set the tempo to one that feels best to you. Refer to page 18 for more information.

4. Adjust the Tuning

The song's tuning can be adjusted in increments of 10 cents. The tuning setting is found in the Utility Mode.

Hold the [SHIFT] button and press the [SAVE/ENT] button to view page 1 in the Utility Mode. Next, press the [▶] button 6 times to view the Master Tuning display shown below, then use the jog dial to adjust the tuning (-24.0 to 0 to +24.0).

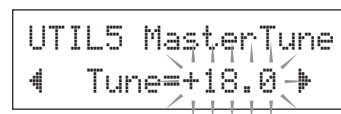
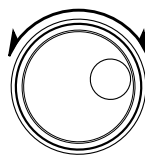

5. Mute the Drum Part

Try playing along with the song.

Hold the [SHIFT] button and press the [SONG ▶/■] button so that the "D" icon appears on the lower right side in the display. This icon indicates that the drum mute function is active. Press the [SHIFT] + [SONG ▶/■] buttons to mute (no sound is produced) the drum part and start playback.

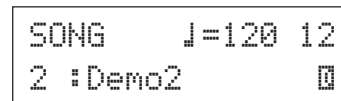

Now play the drum part yourself.

To cancel the drum mute function, hold the [SHIFT] button and press the [SONG ▶/■] button again.

- * The drum mute function is also available during song playback.

Play Along With a Song!

6. Play Along with Bass Solo

With the “Bass Solo” function, you can play along with just the bass part during playback. Since this function mutes the other accompaniment parts, it lets you concentrate on improving your ability to play in rhythm with the bass instrument.

First, press the [SHIFT] + [SAVE/ENT] buttons to view the following display (page 1 in the Utility Mode).

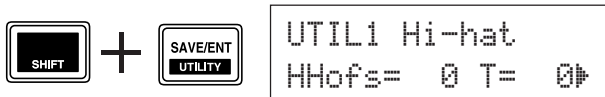

Next, press the [▶] button three times to view the following display.

Rotate the jog dial and select “BassSolo=on”.



With this set, press the [SONG ▶/■] button to start playback and then only the bass part will be heard.

HINT If you have difficulty keeping the tempo when playing with the drum mute or bass solo functions, try using the metronome in combination with the song to give you a better time reference. Press the [ON/OFF] button to have the metronome play in tempo along with song playback. Press the [ON/OFF] button again to stop.

HINT Changing the song will normally change the drum kit to the kit that is already assigned to the song. If you want use a different drum kit when playing along with the song, press the [DRUMKIT] button to enter the Drum Kit Select display, and then select another drum kit number. If a different song is selected when the drum mute is active ([SHIFT] + [SONG ▶/■]), the drum kit will not change when a different song is selected.

Tap Tempo Function

With the Tap Tempo Function, you can set the song or metronome’s tempo by tapping in tempo on a pad. This lets you set the tempo to one that is best for you.

The [◀]/[▶] buttons can also be used to set the tempo instead of tapping on a pad.

Procedure

1. Press the [SHIFT] + [ON/OFF] buttons. The Tap Tempo Setting display shown below will appear.

* The Tap Tempo function can even be used during song or metronome playback.

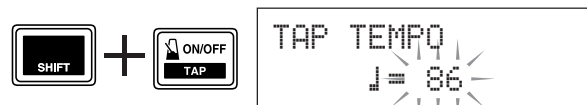

2. Tap on the pad in the tempo you want to play the song at. (Or press the [◀]/[▶] buttons.)

The tempo value determined by the tempo at which the pad was tapped is given in the display.

* Any pad will do.

* The jog dial can also be used to change the tempo value.

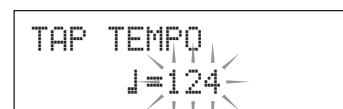

3. Press the [SAVE/ENT] button to set the tempo and the value will stop flashing.

If the song or metronome is playing, the tempo will immediately change to the new tempo.

Create Your Own Original Drum Kit

The DTXPLOTTER lets you create your own original drum kit by assigning drum voices to the pads and setting their tuning, voice, decay, reverb, etc.

1. Select a Drum Kit

Press the [DRUM KIT] button to view page 1 in Drum Kit Select (KIT1).

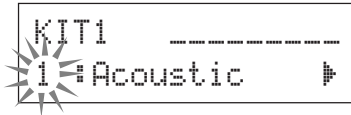

Rotate the jog dial to select the drum kit you would like to use as a starting point for your original drum kit. We recommend that you select a drum kit that is close to the type of kit you would like to create.

* Preset drum kits (No. 1 to 32) and user drum kits (No. 33 to 42) can be used for editing as well.

2. Assign Drum Voices

In this example, we'll create a bass drum (kick) sound.

2-1. Press the [◀]/[▶] buttons to view page KIT2 in Drum Voice Select.

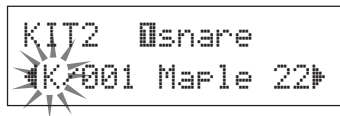

2-2. To select the pad you want to edit (Trigger Input Source), simply hit the pad you'd like to edit, or press the [SHIFT] + [◀]/[▶] buttons.

Step on the kick pedal or press the [SHIFT] + [◀]/[▶] buttons and select "kick". Now the pad that is connected to the 8 KICK Trigger Input Jack is selected or in other words, the kick pedal's pad input is selected.

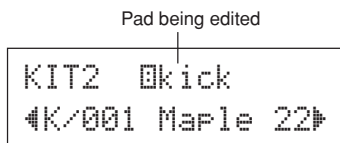

● About the Trigger Input Sources

Sets the voice for each input source of the pad.

The Input Source is trigger data that is transmitted by the pads or trigger sensors connected to input jacks 1 to 9 of the DTXPLOTTER.

When monaural pads TP60/65/80, KP60/65/80, PCY60/65/80/130, DT10/20, etc. are used, one Input Source will be assigned to one input jack.

When stereo pads TP65S/80S, PCY65S/80S/130S, etc. are used, two Input Sources (pad input and rim switch input or 2 kinds of pad input, etc.) will be assigned to one input jack.

When a 3-zone pad such as the TP65S/PCY150S, etc., is used, three Input Sources (pad input and two rim switches, etc.) will be assigned to one input jack.

To select the pad (Trigger Input Source), simply hit the target pad, or press the [SHIFT] + [◀]/[▶] buttons.

Each Input Source is defined as follows.

Snare	Pad input for Trigger Input Jack 1.
SnrR1	Rim switch 1 input for Trigger Input Jack 1.
SnrR2	Rim switch 2 input for Trigger Input Jack 1.
Tom1	Pad input for Trigger Input Jack 2.
Tom2	Pad input for Trigger Input Jack 3.
Tom3	Pad input for Trigger Input Jack 4.
Bride	Pad input for Trigger Input Jack 5.
BrideE	Edge switch input for Trigger Input Jack 5.
Crash	Pad input for Trigger Input Jack 6.
CrashE	Edge switch input for Trigger Input Jack 6.
Open	Pad input (when the hi-hat controller is not fully closed) for Trigger Input Jack 7.
Close	Pad input (when the hi-hat controller is fully closed) for Trigger Input Jack 7.
FootC1	Event when the hi-hat controller is depressed for Trigger Input Jack 7.
Splash	Splash event for the hi-hat controller for Trigger Input Jack 7.
kick	Pad input for Trigger Input Jack 8.
Pad9	Pad input for Trigger Input Jack 9.

* Monaural pads do not have a rim switch function.

2-3. Next, select the Drum Voice Category. Drum voice categories are the same as those used for the metronome's click voice.

● Voice Category

- K: Kick
- S: Snare
- T: Tom
- C: Cymbal
- H: Hi-hat
- P: Percussion
- E: Effect

Here, select "K: Kick".

Press the [◀]/[▶] buttons to move the flashing cursor to the voice category and rotate the jog dial to select "K".

Important!

An asterisk "*" will appear next to "KIT" in the display if data is changed. This is to let you know that data has been changed.

This mark will disappear after the Store Operation (P. 23) is carried out to save data in the DTXPLORER's memory. If a different drum kit is selected, etc., before carrying out the Store Operation, the current settings will return to their original condition. If you want to keep changes made to the data, make sure you carry out the Store Operation.

2-4. Next, select a drum voice.

Press the [◀]/[▶] buttons so that the voice number is flashing, then rotate the jog dial and assign a drum voice. The voice number and voice name will be displayed.

For this example, select "K/001 Maple 22".

* If the voice number is set to "0", "NoAssign" is assigned to the voice name and no sound will be produced.

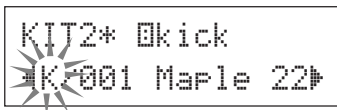

Now you've selected the drum voice that will be used as the base for your original drum voice.

Next, let's edit this drum voice and create an original bass drum voice.

3. Change the Volume

Try changing the volume that is produced by the drum voice when the pad is hit. Use the volume setting to adjust the volume balance between other pad voices.

Use the [▶] button to view page KIT3, then rotate the jog dial to set the volume (0 to 127).

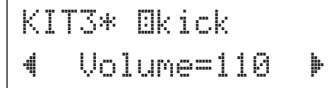

4. Change the Tuning (Pitch)

Try changing the drum voice's tuning (pitch).

Use the [▶] button to view page KIT 4, then rotate the jog dial to set the tuning.

The tuning can be set anywhere between -24.0 to +24.0 cents in increments of 10 cents.

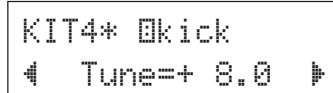

5. Change the Pan

Try changing the drum voice's pan setting (the voice's position within the stereo field).

Use the [▶] button to view page KIT5, then rotate the jog dial to set the voice's pan.

The range is from "L64" (hard left) to "C" (center) to "R63" (hard right). As you rotate the dial, you should notice the voice change its position within the stereo field according to the setting.

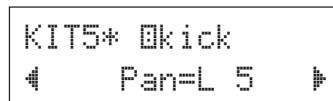

6. Change the Reverb Type

Try changing the type of reverb applied to the drum kit. The same reverb type is applied to the entire drum kit.

Use the [▶] button to view page KIT6, then rotate the jog dial to set the reverb type.

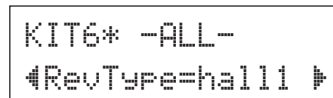

Create Your Own Original Drum Kit

none	No reverb (the same as thru).
hall1 -5	Simulates reverb in a hall.
room1 -5	Simulates reverb in a room.
stage1 -5	Simulates playing on a stage.
Plate	Simulates steel plate reverb.
white	A special short reverb effect.
tunnel	Simulates the reverb of a tunnel.
bsemt	Simulates the reverb of a basement.

* hall, room, or stage effects with larger values produce a greater effect.

7. Change the Reverb Level

Try changing the amount of reverb that is applied to each input source.

Use the [▶] button to view page KIT7, then rotate the jog dial to set the reverb level (0 to 127).

```
KIT7* @kick
◀ RevLevel= 41 ▶
```

8. Change the Decay

Try changing the drum voice's decay time (the time it takes the sound to fade out after being produced).

Use the [▶] button to view page KIT8, then rotate the jog dial to set the decay (-64 to 0 to +63).

Positive values produce a crisper sound.

```
KIT8* @kick
◀ Decay= 0 ▶
```

9. Change the Voice Character (Filter Setting)

Try adjusting the filter's cut-off frequency to change the drum voice's character (brightness).

Use the [▶] button to view page KIT9, then rotate the jog dial to set the cut-off frequency (-64 to 0 to +63).

Positive values create a brighter sound.

```
KIT9* @kick
◀ CutOffFreq= 0 ▶
```

10. Set the Alternate Group

By assigning voices like the hi-hat's open and closed voices—voices that you don't want to have playing at the same time—to the same alternate group, the voice that is currently sounding will be switched off when the trigger for the next voice in the same alternate group is received (after the open hi-hat voice is switched off, the closed hi-hat voice sounds).

Use the [▶] button to view page KIT10, then rotate the jog dial to set the alternate group (off, 1 to 9).

When this setting is set to "off", the mute will not be active.

```
KIT10* @kick
◀ AltGroup= 1 ▶
```

* Some voices such as the hi-hat, etc., already have the alternate group set in their preset settings.

11. Set the MIDI Key ON/OFF

This sets the MIDI note on message's key on/key off for each input source.

Use the [▶] button to view page KIT11, then rotate the jog dial to set key on/key off.

```
KIT11* @kick
◀ KeyOn/Off= norm
```

norm key off is not recognized.
hold Key off is recognized. Every time the pad is hit switches the key on or key off.
0.0s to 9.9s Key off is recognized and the time (gate time) from the key on to key off can be set.

* When this setting is set to "norm", some voices may sound continuously. Press the [DRUM KIT] button to stop the sound.

12. Save the Original Voice

To save the original drum kit you've created thus far, use the store operation described below and save the kit to the DTXPLORER's memory.

Original kits can be saved as a drum kit to the User Drum Kit (33 to 42) allocations.

* If a different drum kit is selected before the store operation can be carried out, all changes you have made to the data will be lost.

12-1. Press the [SAVE/ENT] button. The following display will appear.



```
KIT save to 33
```

12-2. Rotate the jog dial to select the destination Drum Kit number (33 to 42) that you want to store the original drum kit in.

* Data cannot be stored to Preset Drum Kit (1 to 32).

12-3. Press the [SAVE/ENT] button again and the following display asking your confirmation to proceed with the store operation.

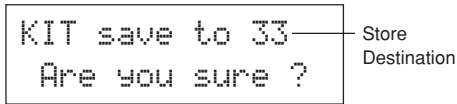

12-4. Press the [SAVE/ENT] button to carry out the store operation.

* To cancel the store operation, press any button except for the [SAVE/ENT] and [SHIFT] buttons (when "Are you sure?" appears in the display, the jog dial will also cancel the operation).

The following display appears after the store operation is complete.

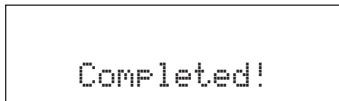

With this, you have created a drum kit that has an original bass drum voice.

Using the same procedures described on the previous pages, create other drum voices for the remaining pads (input sources) and try making a drum kit that uses all original voices.

Factory Set

This operation returns all of the DTXPLORER's internal settings back to their original factory defaults.

Procedure

1. Press the [SHIFT] + [SAVE/ENT] buttons to view the following display (page 1 in the Utility Mode).

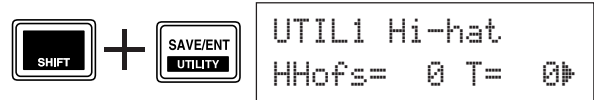

2. Next, press the [▶] button 7 times to view the following display.

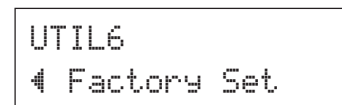

3. Using the display shown above, press the [SAVE/ENT] button and the following display asking for your confirmation to proceed with the Factory Set operation will appear.

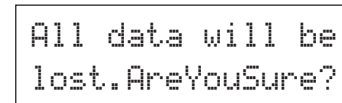

4. Press the [SAVE/ENT] button again to carry out the factory set.

* To cancel the factory set, press any buttons except for the [SAVE/ENT] and [SHIFT] buttons (the jog dial can also be used to cancel the operation).

Trigger Setup Edit

Trigger Setup Edit contains various settings related to trigger input signals received from the pads or trigger sensors that are connected to the Trigger Input jacks. It lets you make adjustments so that the DTXPLORER can better deal with these signals.

If you are using a drum trigger other than those that came with the DTXPLORER set, it will be necessary to adjust the sensitivity or assign voices to the individual trigger inputs. This section also has settings that help prevent cross talk and double triggers.

Selecting the Trigger Setup

The DTXPLORER includes four different preset types (No. 1 to 4) in the Trigger Setup. No. 1 contains data for a basic setup that uses the pads that came with the DTXPLORER connected to the unit's Trigger Input jacks as labeled on the rear panel (1SNARE, etc.). When shipped from the factory, Trigger Setup No. 1 is already selected. No. 2 to 4 also contain setup data designed for use with the DTXPLORER's accompanying pads. Settings related to sensitivity and expression vary in these presets. No. 5 is used for saving a custom setup. Refer to the [Editing the Trigger Setup] section described in the next section for more information on creating a custom setup. Select the Trigger Setup that fits your playing style best. Use the procedure described below to select the Trigger Setup you want to use.

1. Press the [SHIFT] + [DRUM KIT] buttons to view page 1 in the Trigger Setup Select display (TRIG1).

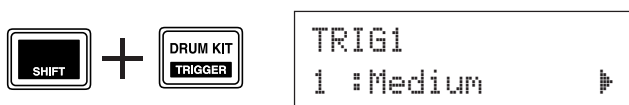

2. Rotate the jog dial to select the trigger setup that matches the drum kit you are using.

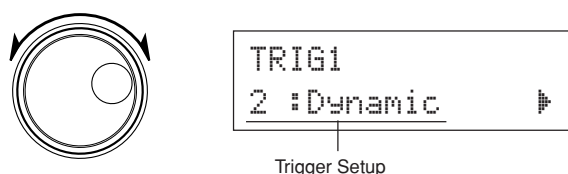

Editing the Trigger Setup

If you are using pads or drum triggers other than those that came with your DTXPLORER, or if you need to solve problems with double triggers or cross talk, the Trigger Setup provides more detailed settings—such as changing the preset's trigger setup—for individual pads.

If you've created a custom setup for reasons described above, that setup can be saved to Trigger Setup No. 5.

1. Press the [SHIFT] + [DRUM KIT] buttons to view page 1 in the Trigger Setup Select display (TRIG1). The currently selected Trigger Setup is indicated in the display.

* If you want to edit a different trigger setup, use the jog dial and select the setup at this point.

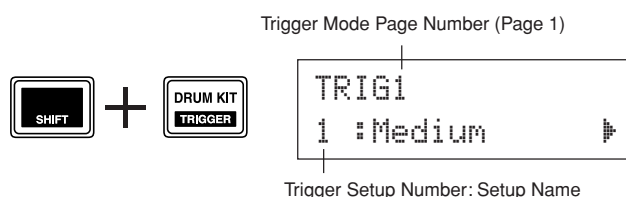

2. Use the setup pages TRIG2 through TRIG8 to edit the Trigger Setup.

Press the [◀]/[▶] buttons to change the page number and move the flashing cursor to the item you want to edit.

* Refer to page 25 for more information on individual items.

To select the Trigger Input (input jack) you want to edit, simply hit the pad you want to edit or use the [SHIFT] + [◀]/[▶] buttons to select the Trigger Input.

● Trigger Setup List

No.	Name	Description
1	Medium	Normal Setting
2	Dynamic	Wide Dynamis Range however, sensitive to vibration.
3	Easy	Averages irregular trigger levels, produces smoother sound.
4	DT10/20	Use with DT10/20 drum triggers attached to acoustic drums.

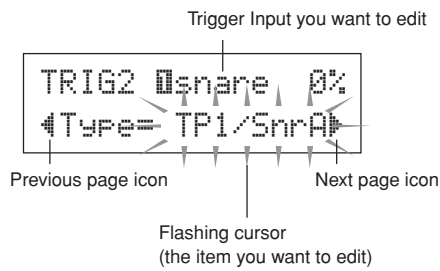

3. Rotate the jog dial to change the setting.

- * An asterisk "*" will appear next to "TRIG" in the display if data is changed. This asterisk will disappear after the store operation is carried out.
- * The Trigger Input Level produced when the pads are hit is given on the upper right side in the display. When setting the gain, use this level as a guide to measure how hard the pads are being hit.

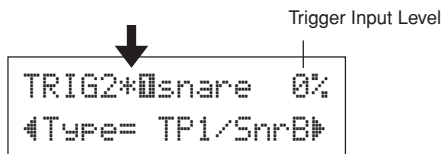

4. To save changes you've made to the data, use the procedure described below to store the data in User Trigger Setup (No. 5).

- * If a different trigger setup is selected before carrying out the store operation, all changes you have made to the data will be lost.

4-1. Press the [SAVE/ENT] button. The following display will appear.

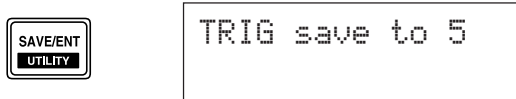

4-2. Press the [SAVE/ENT] button again and the following display asking your confirmation to proceed with the store operation.

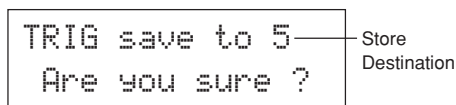

4-3. Press the [SAVE/ENT] button to carry out the store operation.

- * To cancel the store operation, press any button except for the [SAVE/ENT] and [SHIFT] buttons (when "Are you sure?" appears in the display, the jog dial will also cancel the operation).

The following display appears after the store operation is complete.

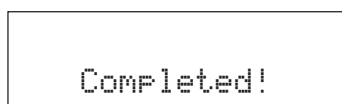

TRIG1 Trigger Setup Select

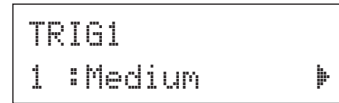

[Range] 1 to 5

Selects the Trigger Setup Type. (P. 24)

TRIG2 Type (Pad Type)

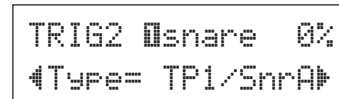

Sets the type of pad that is connected to the assigned input jack shown in the upper half of the display ([1 SNARE] in the example shown above).

- * Values set in [TRIG3 Gain, MVI (Minimum Velocity)] (P. 26) and [TRIG5 SelfRejTime (Self Rejection Time)] (P. 26) will automatically select the proper value for the pad type you set here.

Pad types are defined as follows.

KP	KP80S/80/65/60
TP1/SnrA	TP65S/65 (mainly used as a snare pad) *1
TP1/SnrB	TP65S/65 (mainly used as a snare pad) *1, *2
TP1/Tom	TP65S/65 (mainly used as a tom pad) *1
TP2-A	TP80S/80/65/60 *3
TP2-B	TP80S/80/65/60 *3
PCY1	PCY150S
PCY2	PCY130S/130
PCY3	PCY80S/80/65/60/10
RHH	RHH130
RHP Pad	RHP120SD/120/100/80 (pad side) *4
RHP Rim	RHP120SD/120/100/80 (rim side) *4
RHP Kick	KP120
BP	BP80 *5
DT Snare	DT series drum trigger (for a snare drum)
DT HiTom	DT series drum trigger (for small toms)
DT LoTom	DT series drum trigger (for large toms)
DT Kick	DT series drum trigger (for bass drum)
misc 1 to 6	Another manufacturer's pad 1 to 6.

- *1 3-zone function (pad voice x1, rim voice x2) is available to a 3-zone compatible pad such as the TP65S, etc., if it is connected to the 1 SNARE input.

When connected to the 5 RIDE or 6 CRASH jacks, the rim will produce only one voice. For producing closed rim shots, the [TP1/SnrA] has a high sensitivity setting on rim 1, while the [TP1/SnrB] has a high sensitivity setting on rim 2. Left and right rim sensitivity is set at the same level for [TP1/Tom]. If the pad is connected to any other input, the rim voice will not be produced and the pad will only produce one voice.

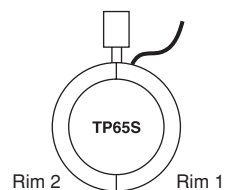

Trigger Setup Edit

- *2 Rim1 and rim2 sounds on the [TP1/SnrB] are reversed from those on [TP1/SnrA]. This provides left-handed drummers with a proper setting when using a left-handed setting.
- *3 When a stereo pad such as the TP80S is connected to the 1 SNARE input, [TP2-A] will produce the sound that is assigned to rim 1, and [TP2-B] will produce the sound assigned to rim 2. (Refer to P.20)
- *4 When an RHP series stereo pad is used, connect the pad to Input 8/9 and set the pad type in Input 8 to [RHP Pad] and the pad type in Input 9 to [RHP rim].
- *5 To use the BP80 as a stereo pad, connect the pad to Input 8/9.

TRIG3 Gain, MVI (Minimum Velocity)

```
TRIG3 [Snare] 0%
[Gain=65MVI= a15]
```

Gain [Range] 0 to 99

Adjusts the input gain (sensitivity) for the input jack shown in the upper half of the display.

Assigning a larger value lets a smaller input level from the pad create sound.

- * This value will be automatically set after the appropriate pad type is set in [TRIG2 Pad (Pad Type)]. Some fine-tuning of the value will be necessary.
- * Some pads are equipped with a sensitivity adjustment knob. Please refer to the Owner's Manual that came with the pad for further information.

MVI [Range] 1 to 127

Sets the MIDI Velocity (volume) that is transmitted when the pad is hit the weakest. Large values will produce a high volume level even if the pad is hit softly. However, this will result in a narrow volume range making it difficult to adequately produce wider dynamic levels.

The trigger input level will be displayed as a % in the upper right hand corner of the display. The maximum velocity (input level 99%) will be 127. The level is low when the pad is hit the weakest so a wider dynamic range will be possible.

- * This value will be automatically set after the appropriate pad type is set in [TRIG2 Pad (Pad Type)]. Some fine-tuning of the value will be necessary.

TRIG4 VelCurve (Velocity Curve)

```
TRIG4 [Snare] 0%
[VelCurve=norm]
```

Sets the Input Velocity Curve for the trigger input jack assigned in the upper half of the display.



TRIG5 SelfRejTime (Self Rejection Time)

```
TRIG5 [Snare] 0%
[SelfRejTime=1]
```

[Range] 0 to 9

Prevents double triggers from occurring in the input jack assigned in the upper half of the display. After an event is detected, further events will be automatically muted for a certain length of time. Larger values set longer times.

TRIG6 Rejection (Rejection Level)

```
TRIG6 [Snare] 0%
[Rejection=2]
```

[Range] 0 to 9

Prevents cross talk from occurring in the input jack assigned in the upper half of the display. Events triggered by other pads (input jacks) that are of a lower input value than what is set here will not be delivered for a set length of time.

TRIG7 SPRej (Specified Rejection Level)

```
TRIG7 0snare 0%
←SPRej=0from= 1→
```

SPRej [Range] 0 to 9
from [Range] 1 to 9, 56

This setting is used to prevent cross talk between the input jack assigned in the upper half of the display and the input jack assigned in the “from=” setting.

After an event occurs from the pad that is assigned in the “from=” setting, the pad assigned in the upper half of the display will not sound for a certain length of time unless the input level is greater than the value set here. Larger values will require a greater input level in order to produce a trigger event.

A “from=56” setting assigns both trigger inputs 5 and 6.

TRIG8 Copy to Input (Trigger Setup Copy)

```
TRIG8 0snare
←Copy to Input=2
```

This function copies all data settings in pages [TRIG2 Type (Pad Type)] through [TRIG7 SPRej (Specified Rejection Level)] to another input jack.

CAUTION

When the Trigger Setup Copy operation is carried out, the trigger setup data will be replaced with the settings of the copy source.

Procedure

1. Hit a pad to select the copy source (trigger input) from which the data will be copied.
 Rotate the jog dial and assign the copy destination (trigger input) to which the data will be copied.

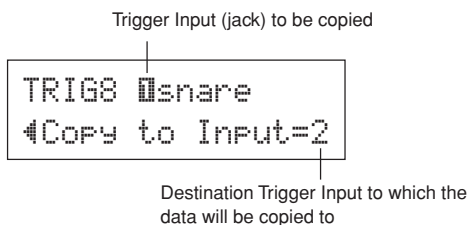

2. Press the [SAVE/ENT] button. The following display asking your confirmation to proceed with the copy operation.

```
Input Copy to 2
Are you sure ?
```

3. Press the [SAVE/ENT] button to carry out the copy operation.

* To cancel the copy operation, press any button except for the [SAVE/ENT] and [SHIFT] buttons (the jog dial will also cancel the operation).

The following display appears after the copy operation is complete.

```
Completed!
```

Error Messages

An Error Message will appear when incorrect settings or operation are detected, or abnormal operation occurs.

Check the Error Message below and make the appropriate corrections.

ERROR
Data Initialized

This message appears just after the power is switched on and the device can not correctly read the data. The cause of the problem may be that the backup RAM data has been damaged or the backup battery power is low. Contact the nearest Yamaha Service Center or the dealer where you purchased the device.

WARNING
Battery Low

The internal memory backup battery power is too low. User data may be deleted. Contact the nearest Yamaha Service Center or the dealer where you purchased the device.

Trouble Shooting

The DTXPLOER does not produce sound, and does not recognize trigger inputs.

- Is the pad or trigger sensor properly connected to the DTXPLOER's trigger input jack? (→ P. 9)
- Is the volume knob on the rear panel turned down? (→ P. 12)
- Is the input level displayed when the pad is hit? (→ P. 25 [Trigger Setup Edit:TRIG2 to TRIG7 pages])
- Is the gain set too low? (→ P. 26 [TRIG3 Gain, MVI (Minimum Velocity)])
- Is the volume setting on the Drum Kit's "KIT 3 Volume" page (→ P. 21) set to "0"?
- Is the cable you are using OK?

The external tone generator does not produce sound.

- Is the MIDI cable (connector) properly connected?
- Is the correct MIDI connector being used?

Produces sound but the sensitivity is too low (volume is low).

- Is the gain set too low? (→ P. 26 [TRIG3 Gain, MVI (Minimum Velocity)])
- Pads with output or sensitivity control volumes should be adjusted (increased).
- Is the minimum velocity set too low? (→ P. 26 [TRIG3 Gain, MVI (Minimum Velocity)])
- Is a proper velocity curve being used? (→ P. 26 [TRIG4 VelCurve (Velocity Curve)])
- Is the volume of the voice you want to use too low? (→ P. 21 [KIT3 Volume])

The trigger sound is not stable (for acoustic drums).

- Check the "Produces sound but the sensitivity is too low (volume is low)." list above.
- Is the proper pad type set? Select a larger pad type setting (DT snare → DT hi tom → DT lo tom → DT kick 1 → DT kick 2) (→ P. 25 [TRIG2 Type (Pad Type)])
- Is the DT20 properly attached with sticky tape? (Is there any old sticky tape remaining on the head?)
- Is the cable securely connected to the DT20 jack?

Double-triggers (when 2 sounds are played at the same time) are produced.

- Pads with output or sensitivity control volumes should be adjusted (lowered).
- Is the gain set too high? (→ P. 26 [TRIG3 Gain, MVI (Minimum Velocity)])
- Use the self-rejection. (→ P. 26 [TRIG5 SelfRejTime (Self Rejection Time)])
- (If you are using trigger sensors) Are you using trigger sensors made by a manufacturer other than Yamaha? Too large a signal can produce double-triggers.
- Is the head causing irregular vibrations? It may be necessary to mute the head.
- Is the sensor attached close to the center of the head? Move the sensor closer to the rim.
- Is the sensor in contact with anything else?

Cross-talk (mixed signals from different inputs) is produced.

- Is the gain set too high? (→ P. 26 [TRIG3 Gain, MVI (Minimum Velocity)])
- Try increasing the rejection parameter. However, a setting a value that is too high may cause the sound to be muted when another drum is hit at the same time. (→ P. 26 [TRIG6 Rejection (Rejection Level)])
- If cross-talk is produced with a specific trigger input, try using specific rejection. (→ P. 27 [TRIG7 SPRej (Specified Rejection Level)])
- Try placing the sensors (DT20, etc.) away from nearby drums.

When 2 pads (drums) are played only 1 sound is heard.

- Raise the gain setting of the pad (drum) that is not producing sound. (→ P. 26 [TRIG3 Gain, MVI (Minimum Velocity)])
- Lower the rejection setting of the pad that is not producing sound. (→ P. 26 [TRIG6 Rejection (Rejection Level)])
- Lower the specified rejection setting of the pad that is not producing sound. (→ P. 27 [TRIG7 SPRej (Specified Rejection Level)])
- Are both pads set to the same alternate group? (→ P. 22 [KIT10 AltGroup (Alternate Group)])

The sound is always loud.

- Is the minimum velocities minimum value set too high? (→ P. 26 [TRIG3 Gain, MVI (Minimum Velocity)])
- Are you using a proper velocity curve? (→ P. 26 [TRIG4 VelCurve (Velocity Curve)])
- Are you using a sensor made by a manufacturer other than Yamaha? Depending upon the manufacturer output levels might be too large.

The DTXPLOTTER does not receive any switch or trigger signals.

- If you can access the Utility mode, do a factory reset. The DTXPLOTTER will reset to its factory settings. (→ P. 23 [UTIL6 Factory Set])
- Turn the POWER switch OFF then ON while holding the [◀] and [▶] buttons. The DTXPLOTTER will reset to its factory settings.

The sound will not stop.

- Is the [KIT11 KeyOn/Off (MIDI Key On/OFF)] setting in the MIDI Key On/Off display set to “norm”? (→ P. 22)
When set to “norm”, some voices may sound continuously. Press the [DRUM KIT] button to temporarily stop the sound.

The Closed Hi-Hat voice is not produced.

- Is the proper pad type selected? If the RHH130 or RHH135 is used as a hi-hat controller, the pad type must be set to “RHH”. (→ P. 25 [TRIG2 Type (Pad Type)])

An optional 3-zone pad connected to the DTXPLOTTER does not produce sound when struck.

- Only the “1 SNARE” trigger input jack on the DTXPLOTTER has the capacity to produce separate sounds for each of the zones on a 3-zone pad. When connected to any other trigger input the pad can only produce sounds set for one or two of the zones. For example, an optional 2-zone RHH130/135 hi-hat pad cannot produce the edge sound when it is connected to the “7 HI-HAT” trigger input, which is only compatible with a monaural pad. For more information, refer to the owner’s manual that came with the pad.

Pad controller functions do not operate properly or functions are not available when an optional pad with pad controller functions is connected to the main unit.

- The DTXPLOTTER is not compatible with pad control functions.

Specifications

Tone Generator	16 bit AWM2
Maximum polyphony	32
Voices	192 drum, percussion voices
Drum kits	32 Preset 10 User memory locations
Trigger setups	4 Preset 1 User memory location
Sequencer tracks	1
Other Sequencer Functions	Mute (rhythm mute), Bass Solo, Groove Check
Song	22 Preset (2 Demo Songs, 20 Pattern Songs)
Controls	
Buttons	DRUMKIT, CLICK, SONG, ►/■, SHIFT, ◀, ▶,  ON/OFF, SAVE/ENT
Controllers	VOLUME, Jog Dial
Display	16 x 2 LCD display (w/Back light)
Connections	MIDI OUT HI HAT CONTROLLER (stereo phone jack) OUTPUT L/MONO (mono phone jack) OUTPUT R (mono phone jack) PHONES (stereo phone jack) AUX IN (stereo mini jack) Trigger Inputs 1, 5, 6 (stereo phone jack→L : trigger input, R : rim switch) Trigger Inputs 2, 3, 4, 7 (mono phone jack : trigger input) Trigger Input 8/9 (stereo phone jack→L, R : trigger input)
Power supply	DC 12V/AC adaptor
Power Requirement	3.2 Watt
Dimensions (W x D x H)	252 x 140 x 54 mm (9-15/16" x 5-1/2" x 2-1/8")
Weight	835 g (1 lbs. 13 oz.)
Accessories	Owner's Manual PA-3C AC power adaptor (included or optional depending on local)

* Specifications and descriptions in this owner's manual are for information purposes only.

Yamaha Corp. reserves the right to change or modify products or specifications at any time without prior notice. Since specifications, equipment or options may not be the same in every locale, please check with your Yamaha dealer.

MIDI Data Format

1. Channel Message

Channel messages described below are sent from the drum triggers only.
Other messages are also sent with the sequencer.

1.1 Key On Key Off

Note range: 0 (C-2) to 127 (G8) (10ch only)
Velocity range: 1 to 127 (note on only)

1.2 Control Change

4 - foot controller (10ch only)

1.3 Program Change

2. System Exclusive Message

2.1 Parameter Change

2.1.1 GM system ON

\$F0 \$7E \$7F \$09 \$01 \$F7 (Hexadecimal)

Sets all the data except the MIDI master tuning data to its initial value.

3. System Realtime message

3.1 timing clock

Sends data.

3.2 start, stop

Sends data.

3.3 active sensing

Send the messages within an interval of approximately 300 msec.

MIDI Transmit Note Number

Input	Instrument	Note Number	Input	Instrument	Note Number
1	Snare	31	6	Clash	49
1	Snare-open rim	34	6	Clash edge	57
1	Snare-close rim	37	7	HI-Hat open	46
2	Hi tom	48	7	HI-Hat close	42
3	Mid tom	47	7	HI-Hat foot close	44
4	Low tom	43	7	HI-Hat foot splash	85
5	Ride	51	8	Kick	33
5	Ride edge	52	9	Option	55

Display Global View

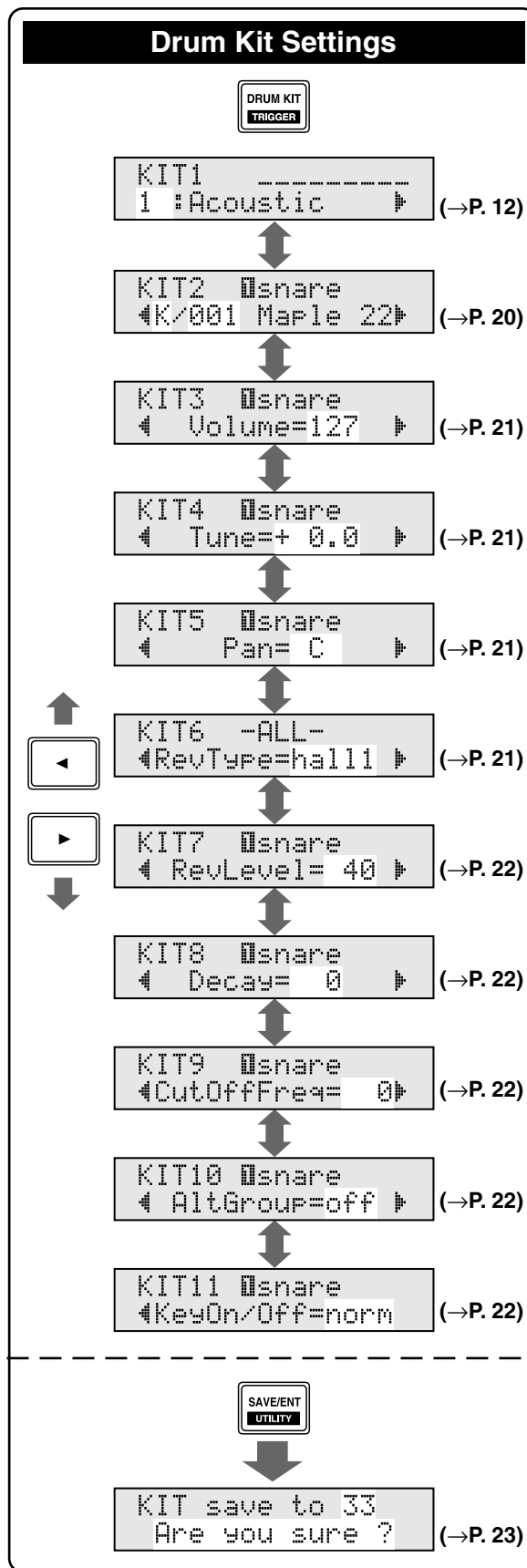
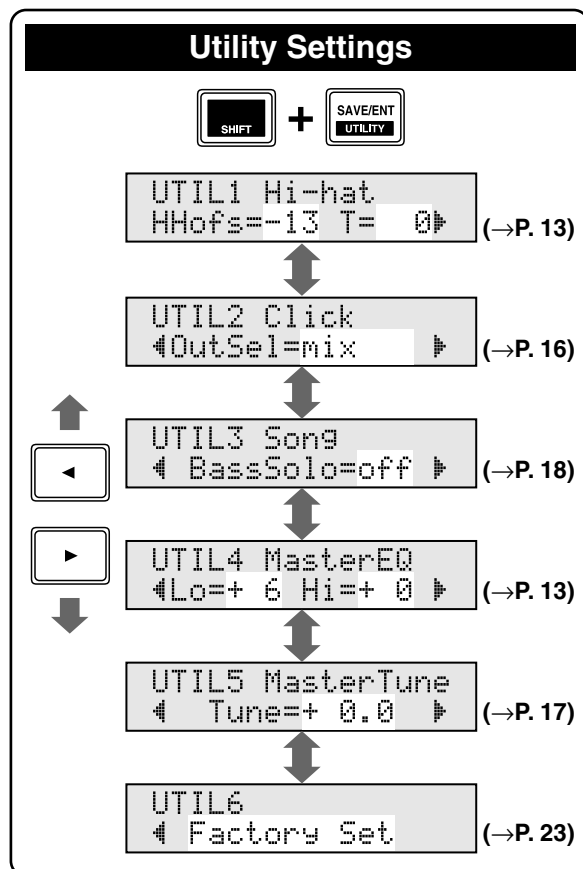
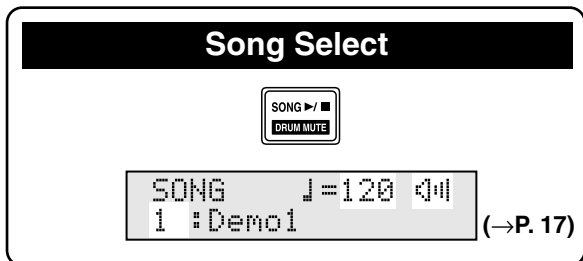
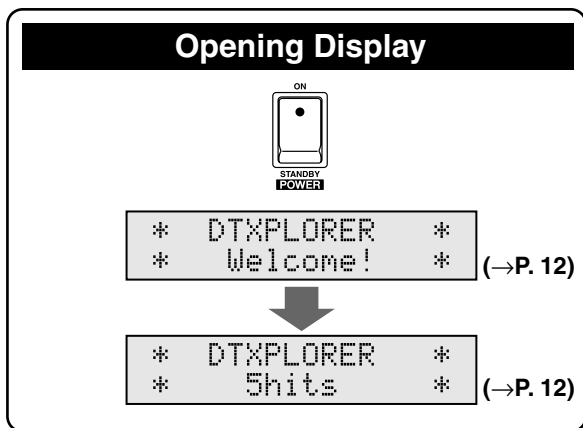

Click Settings

CLICK
GRV.CHECK

CLK1 0 0 0 1 :Beat=4 J=120 (→P. 14)

CLK2 Att=9 J=9
Type=0 V=0 W=0 L=0 (→P. 15)

CLK3 MeasBreak
Meas=- Brk=off (→P. 15)

CLK4 Sound
1:Metronome (→P. 15)

CLK5 Sound=??
E/002 Metron (→P. 15)

CLK6 Sound= J
Tune=- 3.0 (→P. 15)

SAVE/ENT
UTILITY

CLK save to 1
Are you sure ? (→P. 16)

Trigger Setup Edit

SHIFT + **DRUM KIT**
TRIGGER

TRIG1 1 :Medium (→P. 24)

TRIG2 Snare 0%
Type= TP1/SnrA (→P. 25)

TRIG3 Snare 0%
Gain=70MV1= 10 (→P. 26)

TRIG4 Snare 0%
VelCurve=norm (→P. 26)

TRIG5 Snare 0%
SelfRejTime=1 (→P. 26)

TRIG6 Snare 0%
Rejection=2 (→P. 26)

TRIG7 Snare 0%
SPRej=4from= 7 (→P. 26)

TRIG8 Snare
Copy to Input=1 (→P. 27)

SAVE/ENT
UTILITY

TRIG save to 5
Are you sure ? (→P. 25)

Groove Check Function

SHIFT + **CLICK**
GRV.CHECK

GRU1 $\text{---} \text{I} \text{---} \text{---}$
J=120 Gr=-1±1.5 (→P. 19)

GRU2 Parameter
Input=snare (→P. 19)

GRU3 Parameter
Note=J(4) (→P. 19)

GRU4 Parameter
RhythmGate=off (→P. 19)

Tap Tempo Function

SHIFT + **ON/OFF**
TAP

TAP TEMPO
J=120 (→P. 18)

Function ...	Transmitted	Remarks
Basic Default Channel Changed	1 - 16 1 - 16	memorized
Mode Default Messages Altered	x x *****	
Note Number : True voice	0 - 127 0 - 127	
Velocity Note ON Note OFF	o 9nH,v=1-127 x 9nH,v=0	
After Key's Touch Ch's	x x	
Pitch Bender	x	
Control Change	0,4,7,10,32 o 1,6,11,64 x 71,72,73 x 74,84,91 x 100,101 x	
Prog Change : True #	o 0 - 127 *****	
System Exclusive	o	
System : Song Pos. : Song Sel. Common : Tune	x x x	
System :Clock Real Time :Commands	o o	
Aux :All Sound Off :Reset All Cntrls :Local ON/OFF :All Notes OFF Mes- :Active Sense sages:Reset	x x x x o x	

Mode 1 : OMNI ON, POLY Mode 2 : OMNI ON, MONO o : Yes
 Mode 3 : OMNI OFF, POLY Mode 4 : OMNI OFF, MONO x : No

Drum Voice List

● Voice Category

K : Kick
S : Snare
T : Tom
C : Cymbal
H : Hi-Hat
P : Percussion
E : Effect

K : Kick

1 Maple 22
2 MapleVtg
3 MapleAmb
4 Beech 22
5 Birch 20
6 Birch 18
7 DryTight
8 AnalogBD
9 TechnoBD
10 ElecBD 1
11 ElecBD 2
12 ElecBD 3
13 HHopBD 1
14 HHopBD 2
15 HHopBD 3
16 HHopBD 4
17 SlapBass

S : Snare

1 Maple
2 Maple R
3 MapleVtg
4 MapleVtR
5 Rock
6 Rock R
7 Urban
8 Urban R
9 Steel
10 Steel R
11 Brass
12 Brass R
13 Groove
14 Groove R
15 Vintage

16 VintageR
17 Brush
18 Brush R
19 SnrOff
20 SnrOffR
21 CrStick1
22 CrStick2
23 AnaSnr 1
24 AnaSnr 2
25 TechSn 1
26 TechSn 2
27 ElecSn 1
28 ElecSn 2
29 HHopSn 1
30 HHopSn 2
31 HHopSn 3
32 HHopSn 4
33 HHopSn 5
34 HHopSn 6
35 HHopSn 7
36 HHopSn 8
37 HHopRim1
38 HHopRim2
39 HHopRim3
40 DrmnBass
41 SnrRoll*

T : Tom

1 Maple H
2 Maple M
3 Maple L
4 Urban H
5 Urban M
6 Urban L
7 Rock H
8 Rock M
9 Rock L
10 Jazz H
11 Jazz M
12 Jazz L
13 Analog H
14 Analog M
15 Analog L
16 Techno H
17 Techno M

18 Techno L
19 ElectroH
20 ElectroM
21 ElectroL
22 Electr2H
23 Electr2M
24 Electr2L

C : Cymbal

1 CrFast16
2 CrCust17
3 CrLite17
4 CrHevy18
5 CrFast14
6 RdCool
7 RdCoolCp
8 RdDry
9 RdDryCup
10 RdPower
11 RdPowrCp
12 RdSizzle
13 RdSizlCp
14 RdEdge
15 RdSizlEd
16 China 18
17 Splash 8
18 Trash
19 Gong
20 VFX Crsh
21 VFX Ride
22 CrAnalog
23 RdAnalog

H : Hi-Hat

1 HHOpen14
2 HHCise14
3 HHFoot14
4 HHSpls14
5 HHOpen13
6 HHCise13
7 HHFoot13
8 HHSpls13
9 HHDarkOp
10 HHDarkCl
11 HHDarkFt

12 HHDarkSp
13 HHOpen12
14 HHCise12
15 HHFoot12
16 HHSpls12
17 AnalogOp
18 AnalogCl
19 TechnoOp
20 TechnoCl

P : Percussion

1 Agogo Hi
2 Agogo Lo
3 BellTree
4 Bongo Hi
5 Bongo Lo
6 Claves
7 Conga Hi
8 Conga Lo
9 CongaSlp
10 CongaH/S
11 Cowbell1
12 Cowbell2
13 Cowbell3
14 Cowbell4
15 DjembeSb
16 DjembeSl
17 DjembeEd
18 SWhistle
19 Shaker
20 SlelBell
21 StickHit
22 SurdoOpn
23 SurdoMut
24 SurdoM/O
25 TablaByn
26 TablaOpn
27 Tabla Hi
28 TablaMut
29 TablaNah
30 Tambrine
31 TimbalsH
32 TimbalsL
33 Triangle
34 TriangMt

35 TrianO/M
36 Udu Hi
37 Udu Lo
38 UduFingr
39 Udu Slap
40 WinChime
41 WoodBloc

E : Effect

1 ATR
2 MetBell
3 Metron
4 Noise
5 Pulse
6 Zap
7 HandClp1
8 HandClp2
9 RevrsCym
10 RevrsTom
11 Scratch1
12 Scratch2
13 Temple
14 BrassHit
15 StepHorn
16 DreamHt1
17 DreamHt2
18 A Yeah
19 Funky
20 OooWww
21 Sexy
22 YeahHaHa
23 LPLoop *
24 B Loop *
25 SmuthLp*
26 VinylLp*

* Loop

Preset Drum Kit List

No.	Name	No.	Name	No.	Name	No.	Name
1	Acoustic Kit	9	Mixed Voice	17	Deep Kit	25	Tabla Kit
2	Rock Kit	10	Mellow Club	18	Drumn'Bass	26	Ethnic Kit
3	Studio Kit	11	Loop Session	19	All Round	27	Room Kit
4	HipHop/R&B	12	AcousticFunk	20	Power Beat	28	Reggae Kit
5	Vinyl Kit	13	World Kit	21	HornsGroove	29	Ballad Kit
6	Vintage Kit	14	Cool Hip	22	Electro Kit	30	Brush Kit
7	Break	15	Analog Kit	23	Jazz Kit	31	LatinPercs 1
8	Groove Kit	16	Techno Kit	24	Light Shot	32	LatinPercs 2

Preset Song List

No.	Name	No.	Name	No.	Name	No.	Name
1	Demo 1	7	Shuffle	13	HipHop	19	Ballad
2	Demo 2	8	Funk 1	14	Pops 1	20	Samba
3	Rock 1	9	Funk 2	15	Pops 2	21	Bossa
4	Rock 2	10	Dance 1	16	Blues	22	Latin
5	Rock 3	11	Dance 2	17	Reggae		
6	HardRock	12	Soul	18	Jazz		

For details of products, please contact your nearest Yamaha representative or the authorized distributor listed below.

Pour plus de détails sur les produits, veuillez-vous adresser à Yamaha ou au distributeur le plus proche de vous figurant dans la liste suivante.

Die Einzelheiten zu Produkten sind bei Ihrer unten aufgeführten Niederlassung und bei Yamaha Vertragshändlern in den jeweiligen Bestimmungsländern erhältlich.

Para detalles sobre productos, contacte su tienda Yamaha más cercana o el distribuidor autorizado que se lista debajo.

NORTH AMERICA

CANADA

Yamaha Canada Music Ltd.
135 Milner Avenue, Scarborough, Ontario,
M1S 3R1, Canada
Tel: 416-298-1311

U.S.A.

Yamaha Corporation of America
6600 Orangethorpe Ave., Buena Park, Calif. 90620,
U.S.A.
Tel: 714-522-9011

CENTRAL & SOUTH AMERICA

MEXICO

Yamaha de México S.A. de C.V.
Calz. Javier Rojo Gómez #1149,
Col. Guadalupe del Moral
C.P. 09300, México, D.F., México
Tel: 55-5804-0600

BRAZIL

Yamaha Musical do Brasil Ltda.
Rua Joaquim Floriano, 913 - 4º andar, Itaim Bibi,
CEP 04534-013 Sao Paulo, SP. BRAZIL
Tel: 011-3704-1377

ARGENTINA

**Yamaha Music Latin America, S.A.
Sucursal de Argentina**
Olga Cossetini 1553, Piso 4 Norte
Madero Este-C1107CEK
Buenos Aires, Argentina
Tel: 011-4119-7000

PANAMA AND OTHER LATIN AMERICAN COUNTRIES/ CARIBBEAN COUNTRIES

Yamaha Music Latin America, S.A.
Torre Banco General, Piso 7, Urbanización Marbella,
Calle 47 y Aquilino de la Guardia,
Ciudad de Panamá, Panamá
Tel: +507-269-5311

EUROPE

THE UNITED KINGDOM/IRELAND

Yamaha Music U.K. Ltd.
Sherbourne Drive, Tilbrook, Milton Keynes,
MK7 8BL, England
Tel: 01908-366700

GERMANY

Yamaha Music Europe GmbH
Siemensstraße 22-34, 25462 Rellingen, Germany
Tel: 04101-3030

SWITZERLAND/LIECHTENSTEIN

**Yamaha Music Europe GmbH
Branch Switzerland in Zürich**
Seefeldstrasse 94, 8008 Zürich, Switzerland
Tel: 01-383 3990

AUSTRIA

Yamaha Music Europe GmbH Branch Austria
Schleiergasse 20, A-1100 Wien, Austria
Tel: 01-60203900

CZECH REPUBLIC/SLOVAKIA/ HUNGARY/SLOVENIA

Yamaha Music Europe GmbH Branch Austria
Schleiergasse 20, A-1100 Wien, Austria
Tel: 01-602039025

POLAND

**Yamaha Music Europe GmbH
Branch Sp.z o.o. Oddzial w Polsce**
ul. 17 Stycznia 56, PL-02-146 Warszawa, Poland
Tel: 022-868-07-57

THE NETHERLANDS/ BELGIUM/LUXEMBOURG

Yamaha Music Europe Branch Benelux
Clarissenhof 5-b, 4133 AB Vianen, The Netherlands
Tel: 0347-358 040

FRANCE

Yamaha Musique France
BP 70-77312 Marne-la-Vallée Cedex 2, France
Tel: 01-64-61-4000

ITALY

**Yamaha Musica Italia S.P.A.
Combo Division**
Viale Italia 88, 20020 Lainate (Milano), Italy
Tel: 02-935-771

SPAIN/PORTUGAL

Yamaha Música Ibérica, S.A.
Ctra. de la Coruna km. 17, 200, 28230
Las Rozas (Madrid), Spain
Tel: 91-639-8888

GREECE

Philippos Nakas S.A. The Music House
147 Skiathou Street, 112-55 Athens, Greece
Tel: 01-228 2160

SWEDEN

Yamaha Scandinavia AB
J. A. Wettergrens Gata 1, Box 30053
S-400 43 Göteborg, Sweden
Tel: 031 89 34 00

DENMARK

YS Copenhagen Liaison Office
Generatørvej 6A, DK-2730 Herlev, Denmark
Tel: 44 92 49 00

FINLAND

F-Musiikki Oy
Kluuvikatu 6, P.O. Box 260,
SF-00101 Helsinki, Finland
Tel: 09 618511

NORWAY

Norsk filial av Yamaha Scandinavia AB
Grini Næringspark 1, N-1345 Østerås, Norway
Tel: 67 16 77 70

ICELAND

Skifan HF
Skeifan 17 P.O. Box 8120, IS-128 Reykjavik, Iceland
Tel: 525 5000

RUSSIA

Yamaha Music (Russia)
Office 4015, entrance 2, 21/5 Kuznetskii
Most street, Moscow, 107996, Russia
Tel: 495 626 0660

OTHER EUROPEAN COUNTRIES

Yamaha Music Europe GmbH
Siemensstraße 22-34, 25462 Rellingen, Germany
Tel: +49-4101-3030

AFRICA

**Yamaha Corporation,
Asia-Pacific Music Marketing Group**
Nakazawa-cho 10-1, Naka-ku, Hamamatsu,
Japan 430-8650
Tel: +81-53-460-2312

MIDDLE EAST

TURKEY/CYPRUS

Yamaha Music Europe GmbH
Siemensstraße 22-34, 25462 Rellingen, Germany
Tel: 04101-3030

OTHER COUNTRIES

Yamaha Music Gulf FZE
LOB 16-513, P.O.Box 17328, Jubel Ali,
Dubai, United Arab Emirates
Tel: +971-4-881-5868

ASIA

THE PEOPLE'S REPUBLIC OF CHINA

Yamaha Music & Electronics (China) Co.,Ltd.
2F, Yunhedasha, 1818 Xinzha-lu, Jingan-qu,
Shanghai, China
Tel: 021-6247-2211

HONG KONG

Tom Lee Music Co., Ltd.
11/F, Silvercord Tower 1, 30 Canton Road,
Tsimshatsui, Kowloon, Hong Kong
Tel: 2737-7688

INDIA

Yamaha Music India Pvt. Ltd.
5F Ambience Corporate Tower Ambience Mall Complex
Ambience Island, NH-8, Gurgaon-122001, Haryana, India
Tel: 0124-466-5551

INDONESIA

PT. Yamaha Music Indonesia (Distributor)

PT. Nusantik
Gedung Yamaha Music Center, Jalan Jend. Gatot
Subroto Kav. 4, Jakarta 12930, Indonesia
Tel: 21-520-2577

KOREA

Yamaha Music Korea Ltd.
8F, 9F, Dongsung Bldg. 158-9 Samsung-Dong,
Kangnam-Gu, Seoul, Korea
Tel: 080-004-0022

MALAYSIA

Yamaha Music Malaysia, Sdn., Bhd.
Lot 8, Jalan Perbandaran, 47301 Kelana Jaya,
Petaling Jaya, Selangor, Malaysia
Tel: 3-78030900

PHILIPPINES

Yupangco Music Corporation
339 Gil J. Puyat Avenue, P.O. Box 885 MCPO,
Makati, Metro Manila, Philippines
Tel: 819-7551

SINGAPORE

Yamaha Music Asia Pte., Ltd.
#03-11 A-Z Building
140 Paya Lebar Road, Singapore 409015
Tel: 747-4374

TAIWAN

Yamaha KHS Music Co., Ltd.
3F, #6, Sec.2, Nan Jing E. Rd. Taipei.
Taiwan 104, R.O.C.
Tel: 02-2511-8688

THAILAND

Siam Music Yamaha Co., Ltd.
4, 6, 15 and 16th floor, Siam Motors Building,
891/1 Rama 1 Road, Wangmai,
Pathumwan, Bangkok 10330, Thailand
Tel: 02-215-2626

OTHER ASIAN COUNTRIES

**Yamaha Corporation,
Asia-Pacific Music Marketing Group**
Nakazawa-cho 10-1, Naka-ku, Hamamatsu,
Japan 430-8650
Tel: +81-53-460-2317

OCEANIA

AUSTRALIA

Yamaha Music Australia Pty. Ltd.
Level 1, 99 Queensbridge Street, Southbank,
Victoria 3006, Australia
Tel: 3-9693-5111

NEW ZEALAND

Music Works LTD
P.O. BOX 6246 Wellesley, Auckland 4680,
New Zealand
Tel: 9-634-0099

COUNTRIES AND TRUST TERRITORIES IN PACIFIC OCEAN

**Yamaha Corporation,
Asia-Pacific Music Marketing Group**
Nakazawa-cho 10-1, Naka-ku, Hamamatsu,
Japan 430-8650
Tel: +81-53-460-2312

HEAD OFFICE Yamaha Corporation, Pro Audio & Digital Musical Instrument Division
Nakazawa-cho 10-1, Naka-ku, Hamamatsu, Japan 430-8650
Tel: +81-53-460-2445